



University of
Salford
MANCHESTER

1967 - 2017 50 YEARS

**INTERNATIONAL
RESEARCH
CONFERENCE 2017:
SHAPING TOMORROW'S
BUILT ENVIRONMENT
CONFERENCE PROCEEDINGS**

11-12 SEPTEMBER 2017



International Council
for Research and Innovation
in Building and Construction

WELCOME TO DELEGATES IRC 2017

On behalf of the School of the Built Environment at the University of Salford, we are pleased to welcome you to the International Research Conference 2017.

With its focus on *Shaping Tomorrow's Built Environment: Construction and Design for the Modern World*, the Conference provides a forum for researchers worldwide to debate and exchange ideas on a broad range of issues.

As Co-Chairs of the Conference, we are delighted to have the opportunity to hold this Conference in conjunction with CIB. The CIB is the world's foremost platform for international co-operation and information exchange in the area of building and construction research and innovation and this conference is supported by fifteen of the CIB's commissions.

All the papers to be presented at the Conference were selected on the basis of double-blind peer review by the scientific members and paper reviewers to ensure a good quality standard and we hope that delegates will obtain useful feedback on their ideas, gain insights from the work of others and forge connections that will endure into productive joint activity after the Conference.

We wish you an enjoyable and fruitful experience and thank you for your attendance and for making this Conference a successful event.



Professor Hisham Elkadi
*Dean of the School of the
Built Environment and
Conference
Co-Chair*



Professor Les Ruddock
*CIB Board member and
Conference Co-Chair*

ACKNOWLEDGMENTS

Everyone involved on the Organizing Committee, has provided a source of on-going support that is very much appreciated. In particular, without the hard work over several months of Hanneke van-Dijk and Charlotte Houghton the Conference would not be possible.

We wish to thank all the Coordinators of the CIB Commissions that have joined the Conference viz: W55, W65, W70, TG81, W89, W92, W102, W111, W112, W113, W117, W118, W120, W121, and W122 for their support. The Coordinators of these commissions have worked closely with us in coordinating the paper review process.

Our thanks go to the International Scientific Committee members, who made extensive efforts in reviewing papers to tight time scales in ensuring the high quality of the Conference. They have acted as paper reviewers and together have double blind refereed all the papers, so providing the academic backbone to the Conference.

We also thank the Keynote Speakers for their willingness to stimulate invaluable discussions and debate around the Conference theme and the Session Chairs for ensuring that paper presentations operate in an efficient manner.

Finally, we express our gratitude to the following sponsors, who have kindly supported the Conference and donated awards for best papers:

Chartered Institute of Building
Chartered Institution of Civil Engineering Surveyors
CIB
Emerald
Royal Institution of Chartered Surveyors
Taylor and Francis

The Conference Co-Chairs

CONFERENCE ORGANISING COMMITTEE

Conference Co-Chairs: Professor Hisham Elkadi

Professor Les Ruddock

Committee Members: Dr Chaminda Pathirage

Professor Carl Abbott

Mrs Hanneke van Dijk

Miss Charlotte Houghton

Organised in conjunction with Salford Professional Development

THE SCIENTIFIC COMMITTEE

- Professor C Abbott, University of Salford, UK
- Dr A Agapiou, University of Strathclyde, UK
- Professor A Akintoye, Leeds Beckett University, UK
- Professor M Arif, University of Wolverhampton, UK
- Professor D Artan Ilter, Istanbul Technical University, Turkey
- Dr B Awuzie, Central University of Technology, South Africa
- Dr S Azhar, Auburn University, USA
- D Baldry, University of Salford, UK
- Professor C Bevilacqua, Università degli Studi Mediterranea, Italy
- Dr S Biscaya, University of Salford, UK
- Dr L Boshier, Loughborough University, UK
- Professor D Boyd, Birmingham City University, UK
- Dr A Bridge, Queensland University of Technology, Australia
- Dr R A Burt, Auburn University, USA
- Professor N Calavita, San Diego State University, USA
- Dr I Y S Chan, University of Hong Kong, China
- Dr P W Chan, University of Manchester, UK
- J Charlson, University of Wolverhampton, UK
- Professor M Chao-Duivis, Delft University of Technology, The Netherlands
- Dr E Chinyio, University of Wolverhampton, UK
- Dr K Chmutina, Loughborough University, UK
- D Collins, Norwegian University of Science & Technology, Norway
- Dr J Cooper, University of Salford, UK
- Dr J Cross, University of Salford, UK
- Professor A Dainty, Loughborough University, UK
- Professor C Egbu, London South Bank University, UK
- Professor A Elmualim, University of South Australia, Australia
- Professor H Falkenbach, Aalto University, Finland
- Dr Michela Felicetti, Università degli Studi e-CAMPUS, Italy
- Professor R Fellows, Loughborough University, UK
- Dr R Fitton, University of Salford, UK
- Professor Dr J C Gomes, UPT, Porto, Portugal
- Professor J Goulding, Northumbria University, UK
- Dr S Gruneberg, University of Westminster, UK
- Professor G Hansen, Norwegian University of Science & Technology, Norway
- Dr K Haugbølle, SBI - Danish Building Research Institute, Denmark
- Professor T Haugen, Norwegian University of Science & Technology, Norway
- P Huovinen, Tampere University of Technology, Finland
- Dr M C Jefferies, University of Newcastle, Australia
- Professor P A Jensen, Technical University of Denmark, Denmark
- Professor K Jones, Anglia Ruskin University, UK
- Professor K Kähkönen, Tampere University of Technology, Finland
- Professor S Kajewski, Queensland University of Technology, Australia
- Professor D Kashiwagi, Arizona State University, USA
- Dr M Khalfan, RMIT University, Australia
- Professor D Koch, Purdue University, USA
- Professor M Kumaraswamy, University of Hong Kong, China
- Professor J Lai, The Hong Kong Polytechnic University, China

- Dr T I Lam, The Hong Kong Polytechnic University, China
- Professor S Lavy, Texas A&M University, USA
- Professor M Lees, Birmingham City University, UK
- Professor G Lindahl, Chalmers University of Technology, Sweden
- Professor A Liu, University of Hong Kong, China
- Professor J Lopes, Polytechnic Institute of Braganza, Portugal
- Dr C McAleenan, University of Ulster at Jordanstown, UK
- Professor P McDermott, University of Salford, UK
- Professor B Monardo, Sapienza University of Rome, Italy
- Dr A Moustaka, University of Salford, UK
- A Murray, University College London, UK
- Dr G Nardelli, Technical University of Denmark, Denmark
- Professor S Nenonen, University of Auckland, New Zealand
- Dr S Newton, University of New South Wales, Australia
- Professor A L Palazzo, Roma Tre University, Italy
- Professor V Provenzano, University of Palermo, Italy
- Dr F P Rahimian, University of Strathclyde, UK
- Professor S Rowlinson, University of Hong Kong, China
- Professor L Ruddock, University of Salford, UK
- Professor S Santema, Delft University of Technology, The Netherlands
- Dr M Shelbourn, University of Salford, UK
- Professor J J Smallwood, Nelson Mandela Metropolitan University, South Africa
- Dr A Straub, Delft University of Technology, The Netherlands
- Dr S Suresh, University of Wolverhampton, UK
- Professor W Swan, University of Salford, UK
- Professor M Talia, Università degli Studi di Camerino, Italy
- Dr C Thomson, Glasgow Caledonian University, UK
- Dr W Tjihuis, University of Twente, The Netherlands
- Dr C Trillo, University of Salford, UK
- Dr I Trushell, Glasgow Caledonian University, UK
- Professor K J Tu, National Taiwan University of Science and Technology, Taiwan
- Dr J von Meding, University of Newcastle, Australia
- Professor J W F Wamelink, Delft University of Technology, The Netherlands
- Professor T Yashiro, University of Tokyo, Japan

KEYNOTE SPEAKERS

DR. IR. WIM BAKENS

Senior Program Advisor CIB - International Council for Research and Innovation in Building and Construction



ADVANCED EDUCATION

1975 Eindhoven University of Technology - Department of Architectural Engineering, The Netherlands, Master's Degree

1988 Eindhoven University of Technology, The Netherlands, Doctor of Science

Thesis: "Building 2005: Future perspective for company managers, policy makers and researchers in the Building Industry"

PROFESSIONAL CAREER TO DATE

1976 - 1983 Ministry for Housing, Physical Planning and Environment

Along with general responsibility for project, staff and line management at various levels in the organisation, various positions concerning the programming, execution and management of research and development projects in the areas of housing policy and design and building technology.

1983 - 1994 Bakkenist Management Consultants

Partner and head of the Consultancy Group for the Construction Industry, which is a multi-disciplinary group of consultants, responsible for obtaining and executing policy research and management consultancy assignments in the Building and Construction Industry.

1994 - 2017 CIB - International Council for Research and Innovation in Building and Construction

Secretary General of CIB, which is an international association whose objectives are to stimulate and facilitate international collaboration and information exchange between organisations active in the field of Building and Construction Research and Innovation

2010 - Present Visiting Professor at the University of Westminster, London, UK

2017 - Present CIB - International Council for Research and Innovation in Building and Construction

PROFESSOR ANDREW DAINTY

Andrew Dainty is Professor of Construction Sociology in the School of Civil and Building Engineering at Loughborough University, and Director of Loughborough University Doctoral College.



A renowned expert on the sociologies of construction practice, for the past 25 years Andrew's research has focused on the social rules and processes that affect people working as members of project teams. A concurrent stream of work has developed new approaches to managing people within the construction sector, and for integrating human resource management practices with business objectives. A hallmark of Andrew's work is its interdisciplinary nature; he works with academic collaborators from across the engineering, social sciences, business and economics fields and collaborates with many of the UK's leading construction organisations and client bodies. He advises many large organisations as well as government committees and non-governmental organisations.

Over this research career Andrew has led a research portfolio totalling well over £9m and currently holds grants from the EPSRC, ESRC, European Commission, Institute of Safety and Health and Innovate UK. He is also the UK partner of a major grant with the Australian Research Council. He has published over 400 peer reviewed papers (including 175 peer reviewed journal papers), is author/editor of 10 books and research monographs and has written numerous book chapters and professional reports. He currently holds visiting positions at University of New South Wales (Australia) and Universiti Tun Hussein Onn (Malaysia). He has held numerous leadership positions both within the UK and internationally. These include chairing the Association of Researchers in Construction Management (ARCOM) from 2008 – 2010, a member of the CIB Programme Board (2010 - 2013) and as founder and joint coordinator of CIB TG 76 on 'Recognizing Innovation in Construction' between 2012 and 2014. Andrew has recently been appointed as the editor-in-chief of the leading peer-reviewed research journal Construction Management and Economics having been Associate Editor since 2007.

PROFESSOR HISHAM ELKADI

Professor Hisham Elkadi is the Dean and Head of the School of the Built Environment (SoBE) at the University of Salford.

Prior to his appointment, Professor Elkadi was the Chair and Head of School of Architecture and Built Environment at Deakin University, Australia since 2009. His academic career with a Ph.D. from the University of Liverpool in 1989 includes a research associate at the University of Liverpool, a Senior Lecturer at the University of Plymouth, Director of Architecture programme and a Director of postgraduate studies at the University of Newcastle upon Tyne and Chair and Head of School of Architecture & Design in Belfast.



Professor Elkadi has established a sound research network on both national and international levels in the subject of urban ecology. Professor Elkadi has a large number of publications (140+), 5 books, and graduated 19 Ph.D. students. He acted as an invited external examiner at many Universities including Harvard, the University of Toronto, Liverpool, Edinburgh, Nottingham, Beirut, Newcastle, Kuala Lumpur, Curtin, and Newcastle (Australia). Professor Elkadi has been involved in building up bridges and outreach programmes with the local communities in England, Northern Ireland, Italy, Turkey, and Australia. His appointment to the Ministry Advisory Group for the Built Environment in Northern Ireland, a board member of Geelong Australia Art Gallery, and appointment to the Executive committee of the Association of Ulster Architects are recognitions of his commitment to these outreach programmes.

Professor Elkadi is an Honorary Fellow at the University College London, an Honorary Fellow of the Royal Institute of Chartered Surveyors, a Member of Institute of Egyptian Architects, Affiliate of the Royal Institute of British Architects, and a Fellow of the Australia Institute of Buildings. He is a Member of the Standing Committee of Heads of Schools of Architecture in UK, Australian Association of Heads of Schools of Architecture, Member of the Association of the Australian Deans of the Built Environment (ADBED) and Member of the Board of Examiners, ARB-Victoria.

PROFESSOR PETER MCDERMOTT

Peter is Professor of Construction Procurement in the School of the Built Environment, at the University of Salford

He is Joint Co-ordinator for CIB W92. He has developed procurement and performance management systems with major regional and national public sector clients, and worked with the Treasury (Infrastructure UK) and the Cabinet Office on construction and infrastructure strategies.

He is an independent member of the Board for the North West Construction Hub (NWCH) and chairs Constructing Excellence in the North-West.



CONFERENCE DINNER SPEAKER

ROY CAVANAGH MBE

Roy, like Salford University, celebrates a 50 year anniversary this year, his with leading contractor Seddon.

A life-long interest in education sees him chair the 14-19 Education Group for the Construction & Built Environment (C&BE).

He formerly led the C&BE Diploma, chaired the North West Construction Hub (NWCH) Training Group.

Chaired the award winning Salford Construction Partnership and was on the board of Construction for Merseyside.

Awarded the MBE for his services to Construction in 2009 he also was awarded CIOB's International Innovation & Research Award in 2013.

Outside work, Roy is an after dinner speaker and author of over 20 sporting books.



TABLE OF CONTENTS

WELCOME	1
ACKNOWLEDGEMENTS	2
CONFERENCE ORGANISING COMMITTEE	3
THE SCIENTIFIC COMMITTEE	4
KEYNOTE SPEAKERS	6
CONFERENCE DINNER SPEAKER	10
TABLE OF CONTENTS	11
COMMISSION OVERVIEW	16
W55: CONSTRUCTION INDUSTRY ECONOMICS	23
<i>Factors Of Property Value Of Single Family Dwellings In Texas</i>	24
I. Choudhury	
<i>Corruption In The Construction Industry: Comparison Of Survey Results In Croatia And The United Kingdom</i>	34
D. Glavinja, A. Cerić, M. M. Nahod	
<i>A Design Methods Approach Towards Improved Cost Management Of Transport Infrastructure</i>	45
M. Mojtahedi, S. Newton and F. Tahmasebinia	
<i>An Empirical Assessment Of The South African And United Kingdom Property Markets</i>	54
S. Nurick, F. Viruly, K. Mitchell and L. Boyle	
<i>The Construction Sector And The Silver Economy: Addressing The Challenges And Opportunities</i>	65
L. Ruddock and S. Ruddock	
<i>Deep Renovations In Different Business Environments</i>	76
T. Vainio and E. Nippala	
<i>Factors Causing Differentiation In Building Material Prices In South Africa: The Perspectives Of Retailers</i>	84
A. Windapo	
W65: ORGANISATION AND MANAGEMENT OF CONSTRUCTION	93
<i>Project Schedule Optimisation For Safety Management In Construction</i>	94
M. Bragadin and K. Kähkönen	
<i>A Research Roadmap For Megaproject Sustainability Assessment</i>	106
Z. Chen and A. Agapiou	
<i>Evidence-Based Safety Management In Building Refurbishment</i>	119
Z. Chen, S. Maiti and A. Agapiou	
<i>Review Of Construction Practices In The Light Of The Hong Kong First-Ever Competition Ordinance</i>	129
S. O. Cheung	
<i>Realising “Near Zero Carbon” Building Regulation – Comparing Sustainable Housing Developments In Denmark And Sweden</i>	139
C. Koch and S. Gottlieb	
<i>Applicability Of Safe Working Cycle (SWC) Concept To Sri Lankan Construction Industry</i>	151
N.S.K. Mendis, P.A.D. Rajini, A. Samaraweera and Y.G. Sandanayake	
<i>Circular Economy And Real Estate: Alternatives For Operational Lease</i>	164
H.D. Ploeger, M. Prins, A. Straub and R. van den Brink	
<i>Contractual And Ownership Aspects For BIM</i>	177
P. Silius-Miettinen and K. Kähkönen	
<i>Finding The Right Incentives; Circular Business Models For The Construction Industry</i>	189
R. van den Brink, M. Prins, A. Straub and H.D. Ploeger	
<i>Managing Organisational Innovation Capacity For Construction Innovations</i>	201
L. Zhu and S. O. Cheung	

W70: FACILITIES MANAGEMENT AND MAINTENANCE	210
<i>Potential Effects Of Technological Innovations On Facilities Management Practice</i>	211
U.J. Adama and K.A. Michell	
<i>Prevalence Of Factors Affecting Maintenance Management Of Prison Facilities In South-West, Nigeria</i>	220
O. O. Ajayi, J. Faremi and O. A. Adenuga	
<i>Facilities Management And Trends In Business Services Research</i>	230
J. Bröchner	
<i>Bridging The Gap Between Sustainable FM And Sustainable Buildings: An Exploratory Study Of Six Public Buildings In Norway</i>	241
D. Collins, T. Haugen and C. Aamodt	
<i>Facilities Management And Waste Management – Benchmarks And Practices Need Streamlining</i>	255
D. Crawley, T. E. Butt, T. J. Francis, M. A. Nunns and T. J. Allen	
<i>An Input-Output-Based Hybrid (Ioh) Model For Computing Initial And Recurrent Embodied Energy Of Residential And Commercial Sectors</i>	265
M. K. Dixit and S. Singh	
<i>Facilities Management Of NHS Wales – Standardisation And Other Implications</i>	277
P. Evans, T. Francis and T. Butt	
<i>Growing Talent Gap In Facilities Management: Need For Encouraging And Engaging The New Generation</i>	287
N. Gupta, M. Dixit	
<i>Yet Another Trojan Horse? Is Facility Management Ready For Digitalisation?</i>	300
C. Koch, G. K. Hansen and K. Jacobsen	
<i>Improving Facilities To Reduce Carbon Footprint: The Case Of A Commercial Building In Asia</i>	312
J. H. K. Lai	
<i>Key Performance Indicators For Facility Performance Assessment: Measuring Core Indicators Using Building Information Modelling</i>	322
S. Lavy and M. K. Dixit	
<i>Defining Specific Problems In The Thai Government Hospital Buildings. A Study Of Architectural Planning And Space Management Of Maharaj Hospital, Chiang Mai Thailand</i>	331
S. Prugsiganont and P. A. Jensen	
<i>Statistical Optimization Of Degradation Curves: Application To Painted Rendered Façades</i>	346
V. Sousa, C. O. Cruz, I. Meireles and P. Moreira	
<i>Barriers To And Challenges Of Sustainable Facilities Management Practices – Experiences From The Nordic Countries</i>	356
M. Støre-Valen and M. Buser	
<i>Facilities Management, Obsolescence And Design – The Triangular Relationship</i>	369
R. Townsend, T. E. Butt, T. J. Francis, J. Kwan and A. Peterson	
<i>An Implementation Study Of Transferring Project Data From A BIM Software To A FM Software Via The Cobie Standard</i>	382
K.J. Tu and W.C. Chang	
<i>Railway Network Reliability Analysis Based On Key Station Identification Using Complex Network Theory: A Real-World Case Study Of High-Speed Rail Network</i>	395
L. Wang, M. An, Y. Zhang and K. Rana	
<i>Considerations Of Out-Of-Gauge Freight Transportation In Railway Infrastructure Development And Maintenance Projects</i>	409
Y. Zhang, M. An, L. Wang and D. Lei	
TG81: GLOBAL CONSTRUCTION DATA	422
<i>Comparing The Performance Of The Construction Industries In The Countries Of The G20 As Measured By ISIC F Construction And The UK Benchmark Model</i>	423
S. Gruneberg	
<i>Age Composition And Survival Of Public Housing Stock In Hong Kong</i>	434
W. K. Lau, K. M. K. Ho, T. Y. M. Lam, H. C. K. Chan, T. Ma, W. K. D. Wu and C.W. Tsang	

<i>Building Material Price Differentiation In South Africa: The Role Of Retailers And Location</i>	447
A. Windapo and A. Moghayedi	
W89: EDUCATION IN THE BUILT ENVIRONMENT	460
<i>Developing The Social Aspects Of Sustainable Facilities Management: A Multi-Country Summer School Project</i>	461
M. Buser and M. Støre-Valen	
<i>An Analysis Of Research Trends In Construction Project Management</i>	472
P. I. Cakmak and B. Ilhan	
<i>Factors Impacting Upon Student Expectations And Satisfaction With The Quality Of Experience Of Higher Education In England</i>	482
J. Cross and L. Ruddock	
<i>A New Learning Approach For Digital Construction</i>	492
S. Gangatheepan, N. Thurairajah, M. Lees and R. Curzon	
<i>Process Of Research And Education For A Charming ‘Euphony’ Of Signs In Built Environment Design</i>	504
F.G.S. Giucastro	
<i>Creating A Viable Doctor Of Philosophy In The Built Environment: A Case Study Synopsis</i>	517
L. Thomas	
W92: PROCUREMENT SYSTEMS	529
<i>An Evaluation Of The Factors For A Successful Alliance In The United Kingdom (UK) Construction Industry</i>	530
M. Burton and R. Gameson	
<i>So Why Is UK Construction Partnering Not Working The Way It Was Intended?</i>	544
J. Challender, C. France and H. Baban	
<i>The Influence Of Procurement Strategies On SME Contractor Development In The Construction Industry</i>	552
A. Windapo and A. Adediran	
W102: INFORMATION AND KNOWLEDGE MANAGEMENT IN BUILDING	565
<i>Construction Industry Needs An Airbnb Of Its Own!</i>	566
O. Alhava, E. Laine and A. Kiviniemi	
<i>Towards A Framework For Multi-LOD 4D BIM Simulations</i>	578
B. Butkovic and D. Heesom	
<i>Shaping Tomorrows Built Environment: Driving Innovation Through Higher Education Engagement</i>	587
S. Dawson and J.S. Goulding	
<i>Integrating Facility Management Functions In Building Information Modeling (BIM): A Review Of Key Issues And Challenges</i>	597
M. K. Dixit and V. Venkatraj	
<i>A Systematic Literature Review On Sustainable Management Of The Post-End-Of-Life (PEoL) Of Buildings</i>	609
R.S. Jayasinghe, R. Rameezdeen and N. Chileshe	
<i>A Grounded Theory Approach To Mentorship</i>	624
E. A. Lester	
<i>Scenario Manager: Innovative Concept For Process And Information Management</i>	636
M.-C. Loeffler, G. Calleja-Rodriguez and R. Guruz	
<i>Transferring Knowledge From Building Operation To Design – A Literature Review</i>	645
H. L. Rasmussen, P. A. Jensen and J. S. Gregg	
<i>Implementation Of Smart Devices In The Dominican Republic Construction Industry: An Empirical Study</i>	656
M. Silverio, S. Renukappa and S. Suresh	
<i>Knowledge Integration Framework For Traditional Construction Procurement System</i>	664
M. Takhtravanchi and C. Pathirage	

W112: CULTURE IN CONSTRUCTION	674
<i>Developing A Systems-Change Model To Address The Paradox Of Changing Construction</i>	675
R. Garvey and P. McDermott	
<i>Motivations, Success Factors, And Barriers To The Adoption Of Offsite Manufacturing In Nigeria</i>	685
F. Pour Rahimian, J.S. Goulding, A. Akintoye and S.J. Kolo	
W113: LAW AND DISPUTE RESOLUTION	696
<i>The Legal Formation, Governance And Regulation Of International Construction Product Sales Contracts: A Case Study Vignette</i>	697
A. Agapiou	
<i>Collaborative Business Relationships: A Means To An End Of Construction Disputes Or Fuel For The Fire?</i>	707
A. Agapiou and Z. Chen	
<i>The Environmental Law Challenges To The Regeneration Of Brownfield Land</i>	719
J. Charlson and J. Donovan	
W117: PERFORMANCE MEASUREMENT IN CONSTRUCTION	730
<i>Gross Margin Risk Assessment In Construction Projects: The Influence Of Indirect Costs Deviations</i>	731
S. Domingues, N. Almeida and V. Sousa	
<i>Life Cycle Costing In Office Buildings: Key Performance Indicators From DGNB Denmark</i>	744
K. Haugbølle and L. Raffnsøe	
<i>Factors Influencing The Occurrence Of Rework In Construction</i>	757
S. Ndwandwa, E. K. Simpeh and J. J. Smallwood	
<i>An Analytic Network Process Model to Assess the International Competitiveness of Contracting Firms</i>	771
B. Ozorhon, C. Kus and S. Caglayan	
W118: CLIENTS AND USERS IN CONSTRUCTION	782
<i>Comparative Analysis Of Public And Private Client Values For Post Disaster Reconstruction Services</i>	783
S. Aliakbarlou, S. Wilkinson, S. B. Costello and H. Jang	
<i>Integrating Social Sustainability In The South African Construction Industry: Benefits And Barriers</i>	794
B. Awuzie and T. Monyane	
<i>Exploring Conflicting Views Of Time In Construction Projects</i>	805
D. Boyd and S. Madzima	
<i>Shaping Future Construction-Related Business Management: A Review Of 77 Concepts</i>	817
P. Huovinen	
<i>Shaping Client-Driven Business Management Concepts For Modern Construction Markets</i>	830
P. Huovinen, K. Haugbølle and M. Oostra	
W120: DISASTERS AND THE BUILT ENVIRONMENT	843
<i>Understanding Delays In Construction In Conflict Zones</i>	844
B. Razia	
W121: OFFSITE CONSTRUCTION	853
<i>Barriers And Challenges For Offsite Construction In UK Housing Sector</i>	854
M. Arif, P. Killian, J. Goulding, G. Wood and A. Kaushik	
<i>Offsite Manufacturing In Architecture Engineering And Construction: An Unfolding Story</i>	862
J. S. Goulding, F. Pour Rahimian, M. Arif, A. Akintoye and I. Faraj	

<i>Exploring Opportunities Of Integrated Project Delivery In Off-Site Manufacturing Of The Australian Housing Sector</i>	873
O. Ibidapo, K. London, A. Elmualim, Z. Pablo and P. Bayetto	
<i>Main Contractor Perspectives On The Drive For Increased Offsite Manufacture</i>	884
R. Pinney, C. Boothman and A. Higham	
<i>Exploring The Potential Of Offsite Construction To Alleviate Constraints To House Building In Western Australia</i>	896
M. Sutrisna, B. Lofthouse and J. Goulding	
<i>Offsite Construction: An Opportunity For Improving Risk Management</i>	908
L. Zhang, F. Pour Rahimian, A. Agapiou, J. Goulding	
W122: PUBLIC PRIVATE PARTNERSHIPS	916
<i>Critical Success Factors For Public Private Partnership Projects In Developing Countries: Case Of Turkey</i>	917
B. Ozorhon, E. Durna and S. Caglayan	
ENERGY, BUILDING PERFORMANCE AND ENVIRONMENTS	928
<i>Health And Wellbeing In The Built Environment And Its Relevance In Global Sustainable Assessment System</i>	929
Y. Al Horr, M. Arif, A. Kaushik, E. Elsarrag and A. Mazroei	
<i>Application Of Artificial Neural Network Analysis In Defining The Relationship Between Indoor Environment Quality And Occupant Productivity</i>	940
Y. Al Horr, M. Arif, A. Kaushik, P. Tumula, E. Elsarrag and A. Mazroei	
<i>Evaluation Of The New Design Summer Year Weather Data Using Parametrical Buildings</i>	953
Y. Ji, I. Korolija and Y Zhang	
<i>Combined Imaging Technologies For Measuring The In-Situ Thermal And Acoustic Energy Efficiency Of Retrofit Building Elements</i>	966
N. Patil, A. Marshall, R. Fitton and D. Waddington	
<i>Thermal Conditions Within The Campus Of University Of Salford, UK</i>	976
M. Taleghani, R. Fitton and W. Swan	
<i>The Recycling Of Plastic Bottles As A Composite Concrete Block To Increase The Efficiency Of Building Insulation</i>	981
T. Waroonkun, T. Paungphinyo and S. Prugsiganont	
MAPS LED	992
<i>Smart Specialisation Strategy: The Territorial Dimension Of Research And Innovation Regional Policies</i>	993
C. Bevilacqua, V. Provenzano, P. Pizzimenti and C. Maione	
<i>The Role Of Public Authorities In Supporting Regional Innovation Ecosystems: The Cases Of San Diego And Boston Regions (USA)</i>	1004
C. Bevilacqua, A. Spisto and F. Cappellano	
<i>Nature-Based And Innovation-Led Urban Regeneration: A Hypothesis Of Green District For The Metropolitan City Of Reggio Calabria</i>	1018
D. E. Massimo, C. Bevilacqua, P. Pizzimenti and Carla Maione	
<i>Towards Implementing S3. Current Dynamics And Obstacles In The Lazio Region</i>	1030
A. L. Palazzo and K. Lelo	
<i>Towards An Assessment Methodology For Smart Specialisation Strategies: Spatial Ecosystem For Innovators' Hotspots</i>	1041
C. Trillo	

COMMISSIONS OVERVIEW

W55 CONSTRUCTION INDUSTRY ECONOMICS

The Commission's objectives are:

- to be the leading international research focus for the economics of the construction industry
- to stimulate the development of a theoretical base for the discipline of construction economics
- to support and develop the perception of the important role of the construction industry in the economy

The Commission will study, evaluate, disseminate, exchange and discuss issues based on these objectives. The main areas of attention for the Commission's research include:

- Characteristics of the Construction Firm: Strategic, managerial and production based theories; Transaction costs and contracting; M&A, market entry and international construction; Technology uptake models and construction firms
- Characteristics of Construction Markets: Identifying construction firms and markets; Imperfect competition in construction; Game theory in construction bidding and contracting; Auction markets and bidding for construction projects
- Applying Macroeconomic Theory: Use of input-output data for analysis of the construction industry; Asset prices, monetary policy and building cycles; Stages of development and construction activity
- Theoretical Issues: Methodology in construction economics; the property market and demand for new building; and, measuring construction productivity
- Cost Studies and Design Economics: Cost modelling; life-cycle costing and sustainability; value management

W65 ORGANISATION AND MANAGEMENT OF CONSTRUCTION

The rapidly changing needs of modern society poses many challenges for organising and managing construction activities: adapting to the continuous changing context. The scope of W65 covers all aspects of the organisation and management of construction. In particular the following broad themes will pervade many of its activities: Projects, Companies, Policy and Processes.

The objectives of the Commission are:

- to be the leading research and innovation focus for the organisation and management of construction
- to support the creation of construction practices and outcomes that equate to, or exceed, the best found in other industries, in terms of imagination, energy, effectiveness and efficiency
- to stimulate, facilitate and communicate research and innovation, stressing the integration essential for successful innovation in a complex environment

W70 FACILITIES MANAGEMENT AND MAINTENANCE

Enabling the transformation to, and supporting the functioning of, the city of tomorrow, will provide significant new challenges to the way Facilities Managers (FMs) view the design and delivery of services and manage the operation, maintenance and refurbishment of their built assets. Existing service design theories and models are already being challenged by the

emergence of distributed service solutions and the performance of existing built assets are coming under increasing pressure from climate change, societal demographics, and new business models. But, how should FM address these challenges? Which of the existing theories and models will work in the city of the future? What will FM's role be in planning and delivering the transition of existing built assets to those that are fit for purpose in 20, 30 or 40 years' time? These are some of the questions that are being addressed by members of CIB W70: Facilities Management and Maintenance.

The Commission aims:

- to foster a deeper understanding of how our built environment influences human behaviour, health and organizational productivity
- to promote the strategic and operational value of facilities management and asset maintenance in meeting emerging business challenges
- to forge closer links and collaboration between the financial, technical, sociological and operational aspects of facilities management and asset maintenance through an integrated resource management approach
- to disseminate the findings of research work on facilities management and asset management to a wider audience
- to provide a forum for the exchange of know-how and best practice in education, research and industry that addresses physical workplace and functional workspace demands
- to communicate the work of CIB W070 by publication of its symposium proceedings

TG81 GLOBAL CONSTRUCTION DATA

In a rapidly changing planet, it becomes more important than ever to measure changes that are taking place in construction industries throughout the world. We need construction industry statistics on total output, types of building and structures, manpower, labour skills, specialist trades and other key factors. How else can we understand and manage the economic, political and social forces at work? Technology is affecting the rate of urban development and infrastructure investment internationally with implications for productivity and profitability. Governments, financial institutions, industrialists and construction firms and their supply chains all need to study what is happening at a global, national and regional level and they need data to indicate the scale of the problems involved.

We have a vision of the global construction industry that provides a built environment fit for all people by producing that built environment in a safe, productive, sustainable and humane way.

The Task Group aims to contribute to improving:

- the effectiveness of national processes for the gathering of data on various aspects of construction
- international availability and comparability of such data

W89 EDUCATION IN THE BUILT ENVIRONMENT

For Education in the Built Environment, technology continues to change the way we learn by offering ubiquitous access to better materials. It also impacts on the landscape for education

and research as it removes boundaries and shrinks distances. We are certainly on a journey, but where will it lead and how will we get there?

The Commission focuses on the broad discipline of the built environment and its constituent fields. The Commission's aims are:

- to foster high quality academic debate about the way knowledge is generated, codified, taught and learnt
- to promote stronger links between research, scholarship, teaching and practice
- to promote the expansion of the international community of educators in the built environment
- to create and disseminate pedagogic knowledge throughout the community of educators and provide a stronger intellectual basis for practice
- to promote collaboration with other groupings of built environment educators

The Commission will accomplish its objectives through:

- organising international symposia to facilitate debate and the advancement of knowledge
- promoting the publication of scholarly articles on education, pedagogy and educational technology, covering empirical pedagogical research, applied educational theory, and practice issues
- drawing from the international community of educators, examining social and cultural issues surrounding built environment education
- engaging with stakeholders to advance the aims of the Commission

W92 PROCUREMENT SYSTEMS

The main objective for CIB W92 is defined to include both the investigation of the use of procurement to deliver wider sustainability (social, environmental, and economic) goals and the use of procurement to help maximize the value jointly created by the stakeholders in construction and the equitable distribution of the resulting rewards.

The Commission's aims are:

- to research into the social, economic and legal aspects of contractual arrangements, appointment systems and tendering procedures used in relation to construction projects
- to establish and comment upon the practical aims and objectives of contractual arrangements and to define the participants and their responsibilities
- to review areas of commonality and differences
- to formulate recommendations and the selection and effective implementation of project procurement systems
- to compare and contrast standard conventions for the various systems of project procurement generally and specifically
- to report and liaise with relevant CIB Working Commissions and Task Groups

W102 INFORMATION AND KNOWLEDGE MANAGEMENT IN BUILDING

Information is an all-pervading ingredient in building, common to research and practice. By giving proper consideration to the flow of information, research results can be usefully translated into innovation and further adapted to provide the knowledge-base for best practice. In an environment in which the tools for making information available are developing at

breakneck speed, it is necessary to manage the whole spectrum of information forms in a way that reflects the realities of decision-making in modern building practice.

In this context the objective for the Working Commission is to cover concerns that are related to information and knowledge management, both theoretical and practical. Special points of attention are the following:

- interface between general information and the building process and especially the dysfunction in the flow of information between researchers and practitioners. The questions why research results are not put into practice, and how research results and feedback information can be converted and refined to be of practical use will be considered
- contemporary information systems bearing on the information needs of the building industry

W111 USABILITY OF WORKPLACES

Within the scope of the Commission there is a focus on the concept of usability of workplaces, as applied in a range of building types, including commercial buildings and buildings for healthcare and education. Research themes within this scope include:

- Usability concepts, tools and methods
- Economy, efficiency and effectiveness
- Context, culture, situation, performance, experience

The Commission's objectives are:

- to conduct a series of case studies and associated workshops, involving users, practitioners and researchers in a programme of action research
- to develop concepts of usability for application in practice
- to promote, develop and share methods, processes and techniques for the evaluation of the built environment in use.

W112 CULTURE IN CONSTRUCTION

The scope for this Commission reflects the array of important business concerns deriving directly from underpinning culture – organizational climate, ethics, corporate social responsibility (CSR) and organizational citizenship behaviour (OCB). The construction industry itself as field of interest is considered on international, national and local scales, focusing on the processes, (project-) experiences, and the parties involved.

Against this background the objectives of W112 are:

- to continue to research National Cultures and Organizational Cultures relating to construction worldwide to maintain and extend the 'Inventory of Culture in Construction'
- to extend the methods of research employed to encompass more longitudinal approaches to enable evolutionary aspects of culture to be included in investigations
- to research into the related cultural topics of organizational climate, ethics, CSR, and OCB; and other related topics to provide a more comprehensive understanding of culture and its consequences
- to enhance relationships with other CIB Commissions, and beyond, to disseminate findings and stimulate further collaborations and investigations.

W113 LAW AND DISPUTE RESOLUTION

The Commission's primary function is to coordinate the identification of, and response to, the multitude of emerging legal challenges faced by the construction and property industries worldwide. In this context the Commission's objectives are:

- to establish a thriving international research community in the fields of law and dispute resolution
- to contribute to the wider building and construction research agendas through encouraging the active engagement of legal scholars with other specialists in the field
- to coordinate efforts to identify and address emerging legal challenges faced by the global construction and property industries through building a coalition of stake-holders from industry, the professions and academia
- to generate interest in the application of law in an international construction and property context amongst legal specialists in the legal professions and law faculties worldwide
- to increase the understanding of obstacles to effective transnational construction operations and building performances management by facilitating the development of comparative legal methodologies and research projects.

W117 PERFORMANCE MEASUREMENT IN CONSTRUCTION

The need to understand and appropriately benchmark and use performance data, together with the consequences of non and inappropriate use, are essential for the development of the construction industry worldwide. Against this background the Commission's objectives are:

- to explore the optimal uses of performance information in the built environment
- to create a worldwide resource centre of knowledge of proven methods for implementing and sustaining performance metrics in an organization or in the industry
- to develop performance measurements as appropriate for different countries by engaging researchers and practitioners worldwide
- to support researchers, scholars and practitioners and like-minded individuals and organizations in their quest to improve their understanding and awareness of Benchmarking Construction Performance Data.

W118 CLIENTS AND USERS IN CONSTRUCTION

Clients and users play a significant role in shaping construction and real estate. Getting a better grasp of their aspirations, needs and behaviour will open up new and important roads for the industry to deliver more value for money. Against this background the aim of the Commission is:

- to bring together the experience and expertise of researchers and practitioners
- to develop, share and disseminate appropriate research theories and practices for the successful client management of procurement and innovation
- to encourage and facilitate new collaborative and multi-disciplinary research both within and outside of CIB.

The Commission will define what constitutes clients and users in construction, will identify appropriate procurement and management strategies, will classify methods for engaging users in decision making processes and will develop appropriate related guidance material for clients and users.

W120 DISASTERS AND THE BUILT ENVIRONMENT

The rapid growth of urban centres presents numerous challenges to humanity, many of which can be addressed through built environment solutions. In the face of more frequent and powerful hazards, the future of vulnerable and growing populations is increasingly perilous. Against this background the objectives of the Commission are:

- to explore optimum means of engaging multiple stakeholders in collaborative projects that address the issues of disaster and development through built environment solutions
- to encourage strategic urban planning through the development of an evidence base supporting built-in disaster risk reduction (DRR)
- to advocate for the deployment of appropriate built environment professionals in support of DRR activities
- to develop tools / frameworks / models to support built environment organizations in complex environments in a variety of global contexts
- to support the embedding of disaster and development issues in the curriculum of built environment disciplines globally, encouraging the consideration of broader career paths.

W121 OFFSITE CONSTRUCTION

The precursor of this Commission, CIB TG74, produced a Research Roadmap for Offsite Construction that emphasized the need for work in such areas as: design / construction / manufacturing, with specific emphasis on ICT integrated solutions, socio-economic drivers, identifiable costs and value streams, including the need for skill development to support the concept of offsite construction. One of the main challenges highlighted for integration, particularly in aspects relating to the design, construction and manufacturing industries, to enable process innovation in offsite construction, which will be the prime focus of the Commission in the 2016 - 2019 period.

Against this background, within the scope of the Commission the focus will be on: Process improvement; innovation; visualization; process models; strategic and operational business models; and, training and development.

W122 PUBLIC PRIVATE PARTNERSHIPS

Amidst mounting global pressures for more effective and efficient forms of PPP, specific current needs were identified and presented in the CIB PPP Research Roadmap. This presents as main research themes: Financing and financial models and structures; risk allocation and management; transparency and accountability including regulatory and institutional frameworks; public policy and private/public sector behaviours; PPP project evaluation; contractual structure; and, PPP Performance Indicators.

New innovations and novel approaches are being developed in the formulation and implementation of PPP around the world. This calls for a new or additional research agenda for PPP, in addition to the roadmap already produced.

The scope of the Commission is informed by the description of Public-Private-Partnerships (PPP) as joint ventures, in which a private consortium and public or governmental bodies cooperate; each applying its strengths to develop a project to deliver public services more quickly, more efficiently and with better value for money. Consequently, the Commission will

facilitate a research forum for academics, practitioners and experts in the field at international, national and regional levels.

ENERGY, BUILDING PERFORMANCE AND ENVIRONMENTS

The issue of energy consumption in both new and existing buildings is a major issue for the built environment. Energy efficiency plays into issues of climate change, fuel poverty and energy security and remains a global challenge. This stream is concerned with understanding the energy efficiency of buildings, how this affects building performance and with the wider issues of how buildings will perform into the future. There is also a focus on how we can use models and measured performance to help us better understand how to address these issues and better understand phenomena such as the performance gap. Examples of research areas include:

- Building energy performance – energy efficiency, building physics
- Internal environments and human factors – thermal comfort, visual comfort, indoor air quality
- Modelling and measurement methods and issues – methods for modelling and measuring buildings and external environments
- Future climate and responses – urban heat islands, future climate, models and decision making
- Eco-innovation and sustainable construction – technical solutions to improving building performance now and in the future

W55: CONSTRUCTION INDUSTRY ECONOMICS

FACTORS OF PROPERTY VALUE OF SINGLE FAMILY DWELLINGS IN TEXAS

I. Choudhury

Department of Construction Science, Texas A&M University, College Station, TX 77843, USA

Email: i-choudhury@tamu.edu

Abstract: The purpose of this study was to ascertain the factors of property value of a single-family dwelling in twin cities of Bryan and College Station in Texas, USA. Probable correlates of the value of a single-family, detached dwelling include both physical and environmental attributes. The action of buying or selling a house requires a reliable estimate of its value. People take into account both physical and environmental attributes of a house when they want to buy one. Physical characteristics include the size of the dwelling, number of bedrooms and bathrooms, location, and lot size; environmental attributes include the quality of immediate outdoor spaces of the dwelling, defined as curb appeal and measured using territorial markers, and degree of maintenance of front yard. A sample of 112 single-family dwellings from 14 neighborhoods was randomly selected for the study in a university town in Texas, USA. Data related to all the variables included in the model was collected. Statistical technique used for data analyses was General Linear Model. Results indicated that the size of dwelling, number bathrooms, location, and at least one environmental attribute have a statistically significant effect on the property value of single family dwellings.

Keywords: Environmental Attributes; General Linear Model; Physical Attributes; Property Price; Single-Family Dwelling.

1. INTRODUCTION

A single family dwelling, also called single family detached dwelling, is a free-standing residential building built on lots larger than the structure itself, surrounded by open spaces all around. Since the building is detached, the potential size of such a house is limited only by budget of the owner and local codes. The action of buying or selling a house requires a reliable estimate of its value. People take into account both physical and environmental attributes of a house when they want to buy one. Physical characteristics include the size of the dwelling, number of bedrooms and bathrooms, location, and lot size; curb appeal variables include the quality of immediate outdoor spaces of the dwelling, measured using territorial markers, and degree of maintenance of front yard.

Since a single family dwelling is mainly characterized by its location, size, and quality, its price is a function of a variety of all these factors taken together. Each house may have its own unique set of characteristics that affect its value. A house by the lake side may have a different price than a house of same size near a park. The buyers also may evaluate the individual characteristics differently. Thus the perceived value of a house with the same characteristics may differ from buyer to buyer.

Despite a house being heterogeneous good, a significant number of studies have been conducted to explain the value of house by assigning values to its individual components. As far physical attributes are concerned, housing is considered as a bundle of its physical characteristics and environmental features.

Landscape of private outside space is a very significant part of an urban environment. Well-designed and well-maintained private outside space of a single-family dwelling adds not only to the aesthetic aspects of the residence but also enhances the quality of a neighborhood. While both front and back yards are parts of the private outside space, generally front yards are visually accessible to outsiders. Curb appeal of a house is usually dictated by the quality of front yard.

Primary purpose of this study was, therefore, to find out the effect of both physical and environmental attributes of single family dwellings in two neighboring cities in Texas. The physical attributes included number of bedrooms and bathrooms, total built-up area, location, and lot size. The environmental attributes consisted of curb appeal and degree of maintenance of front yard. It was hypothesized that property values of single family dwellings are affected by both physical and environmental attributes of the dwellings.

2. REVIEW OF THE LITERATURE

2.1 Physical Attributes

Studies (Emarth & Taylor, 2011; Sirmans & McPherson, 2003) on housing emphasize on understanding the marginal effects of all physical attributes of a dwelling in order to figure out their overall impact on prices. Attributes that are most frequently included in housing models include built-up area, number of bedrooms and bathrooms, lot size, location, and public services. A study by Emarth & Taylor (2011) reveals that, keeping all other variables constant, adding an additional bedroom may increase the house price by about \$9,500; an additional bathroom may enhance it by about \$25,000. However, estimated coefficients for bedrooms, bathrooms, built-up area, and lot size vary significantly by geographical regions (Sirmans *et al.*, 2005). Most of the attributes are not found to be sensitive to time. Bedrooms, as reported by Sirmans & McPherson, (2003) are shown to be negatively correlated with price, but bathrooms almost always have a positive relationship.

Using a database of 2,888 single-family dwellings Cebula (2009) found positive relationships between housing price, and multiple explanatory variables, including number of bedrooms, bathrooms, and various other amenities. The study also revealed positive relationship between home value and the presence of cul-de-sacs; proximity to apartment complexes and busy roads negatively affected sale prices.

Interestingly, value added price for a bedroom in case of a high-end dwelling is usually higher than that for a mid or low-end dwelling. Because of this reason, researchers usually transform the value of a home, when used as a dependent variable in regression analysis, to its natural logarithm. It is regressed against untransformed values of independent variables (Malpezzi, 2002). This allows deviation in attribute prices across different value ranges within a sample.

The inclusion of external features of dwellings such as carport, deck, garage, pool, and porch are also not uncommon. Emarth (2011) finds that a home without garage has definitely a negative impact on the selling price; existence of a swimming pool, on the other hand, has statistically significant effect on the value (Sirmans & McPherson, 2003).

Some features of a dwelling are likely to be correlated to each other. Built-up area and number of bedrooms is a good example of this multicollinearity. It may result in some variables duplicating the information contained in other variables. Many studies on housing values expose this issue which is particularly tricky when attempting to explain the determinants of price (Romkaew, 2001).

2.2 Environmental Attributes

Among a number of environmental attributes, curb appeal seems to be quite important. Curb appeal is the visual attractiveness of a commercial or residential property when viewed from the street side. This term is extensively used by real estate professionals as an indicator of initial appeal to prospective buyers of a property.

The term curb appeal includes the visual interest of spaces that are public as well as private. Public spaces might contain places for recreation like public parks, specialty parks and forest land while private open spaces mostly consist of farms and yards (specifically, front yard of houses). Proximity of a property to these open spaces is a very important deciding factor for the buyers. This implies that the relationship of the residents with the dwellings and the surrounding outside open space is an important factor to be considered and an interesting field to explore (Lawrence, 1981).

Neumann (2005) suggests that direct benefits result when individuals experience the positive effects of open space as a result of their physical location. For instance, effective manipulation of an open space often produces an amenity that is capitalized into neighboring property values.

A vast majority of American housing consists of single-family dwellings on private plots of land. Historically, the private outside space of these dwellings has been a tool in the hands of its residents for maintaining, adapting, modifying the immediate surroundings in ways that are satisfying to them. It not only provides a place for outdoor enjoyment, but also indicates the social standing of the resident. People feel a sense of accomplishment when their yards look equal to or better than their neighbors (Choudhury 2001). This, in turn, tends to increase the market value of the dwellings. If a house is on sale, most buyers form an opinion about it even before they step foot in the front door (Esajian, 2014).

Attributes of front yards that are generally considered as predictors of curb appeal include the quantity of space, maintenance level of yards, adequacy of such space for activities, and territorial personalization. Territorial personalization becomes tangible through embellishment of the spaces by the residents. Higher levels of such personalization, achieved through territorial marker components, are associated with increased level of residential satisfaction. Territorial markers include trees, shrubs, flower beds, sculptures, bird baths, fountains, and such other adornments. This process of personalization also results in improving the curb appeal of the houses. An increased curb appeal, in turn, possibly results in an increased property value.

An informal survey of real estate professionals by Rodriguez & Sirmans (1994) reveals that homes with visually attractive front yards are preferred to the ones with rather plain front yards. A presence of potted plants at front, flowers in the garden, updated shrubs with fresh mulch, and trees create visual interest (Esajian, 2014). Even though there is no formal premium to

sellers of homes with “good views”, but quite often such homes sell for 5 to 15 per cent more than homes without “good views.”

A study by Sander *et al.* (2010) indicates that trees play a major role in determining property value in an urban environment. They used a hedonic property price modeling to estimate the effect of trees on or near the property in Ramsey and Dakota counties in Minnesota. The findings indicate that trees in and around a property result in an increase in its value ranging from \$836 to \$1,371. The study provides evidence that the presence of healthy shade trees contribute to a large extent to a home's "sell-ability" by adding to the curb appeal.

Measuring curb appeal does not consist of simple calculation. It is a complex problem under which several factors have to be considered and measured in order to obtain a meaningful value. Personalization of one’s immediate outdoor environment enhances the level of pride and, consequently, satisfaction with the property owner’s residential environment as a whole. The use of territorial markers (such as bushes, flowerbed, trees, water fountain, bird bath, etc.) for such personalization is considered by some real estate professionals as considerably good measure of outdoor space quality (Choudhury & Trivedi, 2011).

Another measure according to real estate professionals is the maintenance level of yards. One of the main components of the yards of a single family dwelling is grass. Grasses have been utilized by people for generations to enhance their living environment. Beard & Green (1994) report that apart from many functional and aesthetic benefits, grasses also contribute to increased property values.

Curb appeal starts with condition of grass and landscaping in front of the house. A lush green and well-maintained lawn enhances its visual quality. A majority of American homeowners believe that investment in lawns increases property value. A study by Behe *et al.* (2005) shows that sophistication of landscaping of the yards has an effect on perceived sales prices. Proper and well maintained landscaping adds about 15 per cent to a home's value according to buyers (Roman Empire Landscaping, 2009). Garskof (2008) advises home-owners to turn the front yard to a “green carpet” for increasing property value.

3. METHODOLOGY

3.1 Study Population

The study population consisted of 112 single family dwellings in 14 randomly selected residential neighborhoods in the twin cities of Bryan and College Station in Texas. Sixteen dwellings were randomly selected from each neighborhood. Total number of residential neighborhoods in Bryan is 46 and that in College Station is 48.

A large sample size decreases estimation error in statistical analysis. But for practical reasons such as time constraint and financial costs, size of samples have to be restricted. As a “rule of thumb,” a sample size of ± 50 is considered to be adequate for common statistical tests (van Vootis & Morgan, 2007). However, we increased the size of our sample to more than twice the recommended reasonable number. We wanted to distribute the sample among 10 to 15 percent of neighborhoods, equal number in Bryan and College Station. This decision led to the random selection of 14 neighborhoods, seven each in Bryan and College Station, and make the sample size of dwellings 112, eight from each neighborhood.

3.2 Data Collection Procedure

Data related to physical attributes of the dwellings was gathered from the database of real estate sites accessible online. Current property values of the units were also obtained from the same sites. Data on curb appeal attributes was gathered by personal visits to the sites. Use of territorial markers and levels of maintenance of front yards were observed and recorded during the visits. Photographs of the sites (with prior permission of the owners) were also taken to supplement personal observation. Data collection was done in the summer of 2016.

3.3 Variables

3.3.1 Environmental Attributes

Territorial markers (TMARKER): This is the observed modification and adornment of the front yard by a household. This was measured through identification of territorial markers (trees, flowerbeds, bushes, bird baths, fountains, etc.). In order to provide equal weightage, presence of each marker was given a value of 1. It was the sum of the value of all territorial markers present on the front yard.

Maintenance of front yard (MAINTAIN): This is the observed level of maintenance of the front yard. It was measured by observing the level maintenance on a five-point scale, ranging from 1 (very poorly kept) to 5 (very well-kept).

3.3.2 Physical Attributes

Number of bedrooms (BEDROOM): It is the total number bedrooms in a single family dwelling. It was measured simply by counting the number of bedrooms.

Number of bathrooms (BATHROOM): It is the total number bathrooms in a single family dwelling. It was measured simply by counting the number of bathrooms.

Built-up area (AREA): It is the total built-up area of a single family dwelling. It was measured in square foot.

Lot size (PLOT): It is the size of property on which a single family dwelling has been constructed. It was measured in square foot.

Property price (PRICE): It is the appraised value of a single family dwelling along with the lot on which it has been constructed. It was measured in US Dollars.

Location (NHOOD): It is the neighborhood where a single family dwelling is located. This is category variable consisting of 14 locations. The locations were identified by numbers ranging from 1 to 14.

4. ANALYSES AND RESULTS

The data was analyzed using General Linear Model. Pearson's Correlation technique was used to test the hypothesis that property values of single family dwellings are affected by both physical and environmental attributes of the dwellings.

GLM is an analysis of variance procedure in which the calculations are performed using a least squares regression approach to describe the statistical relationship between one or more predictors and a continuous response variable. Predictors can be factors and covariates. The design may be balanced or unbalanced. GLM can perform multiple comparisons between factor level means to find significant differences. The following model was used for analysis, transforming the value of the dependent variable (PRICE) to its natural logarithm:

$$\text{LNPRICE} = \beta_0 + \beta_1\text{BEDROOM} + \beta_2\text{BATHROOM} + \beta_3\text{AREA} + \beta_4\text{PLOT} + \beta_5\text{TMARKER} + \beta_6\text{MAINTAIN} + \beta_7\text{NHOOD} \quad (1)$$

Where

LNPRICE = the price of the single-family dwellings in US Dollars, transformed to its natural logarithm

BEDROOM = the number of bedrooms,

BATHROOM = the number of bathrooms,

AREA = the total built-up area of a single family dwelling,

PLOT = the size of property on which a single family dwelling has been constructed,

TMARKER = the observed modification and adornment of the front yard by a household, and

MAINTAIN = the observed level of maintenance of the front yard,

NHOOD = a category variable identifying the location of a single family dwelling,

β_0 = intercept, and

$\beta_1, \beta_2, \text{etc.}$ = regression coefficients.

Results of the analysis are shown in Tables 1 and 2.

Table 1: Results of General Linear Model analysis

Source	F-value	Significance (p-value)
Corrected Model	40.956	0.000
Intercept	11825.307	0.000
PLOT	0.984	0.324
AREA	49.242	0.000
BEDROOM	0.016	0.901
BATHROOM	8.321	0.005
MAINTAIN	0.009	0.923
TMARKER	4.366	0.039
NHOOD	17.222	0.000

R Squared = 0.894 (Adjusted R Squared = 0.872)

Table 2: Parameter Estimates (t-values)

Parameter	Coefficient	t-value	Significance (p-value)
Intercept	11.150	106.140	.000
PLOT	2.810E-6	.992	.324
AREA	0.00030751770	7.017	.000
BEDROOM	-.004	-.125	.901
BATHROOM	.096	2.885	.005
MAINTAIN	.002	.097	.923
TMARKER	.014	2.090	.039
CITY= Bryan	.072	1.002	.319
CITY= College Station	0 ^a	.	.
NHOOD= Chimney Hill	.081	.992	.324
NHOOD=Breezy Heights	.544	7.434	.000
NHOOD=Carter's Grove	-.081	-1.084	.281
NHOOD=College Hills Estates	.400	5.554	.000
NHOOD=College Hills Woodlands	.320	3.983	.000
NHOOD=Culpepper Manor	-.165	-2.292	.024
NHOOD=Glenhaven	.052	.667	.506
NHOOD=Lakeview North	-.609	-8.233	.000
NHOOD=North Garden Acres	-.187	-2.539	.013
NHOOD=North Oakwood	.061	.800	.426
NHOOD=Scasta Place	-.145	-1.943	.055
NHOOD=The Oaks	-.162	-2.265	.026
NHOOD=Timber Ridge	0 ^a		
NHOOD=Windover East	0 ^a		

a. This parameter is set to zero because it is redundant.

The model, which is derived from empirical data, needs to be checked for its predicative efficacy. A widely used measure for checking the predicative efficacy of a model is its coefficient of determination, or R^2 value. Perfect relation is said to exist between the dependent and independent variables, if R^2 is 1 and no relationship exists between the dependent and independent variables, if R^2 is 0. Predictive efficacy of this particular model was found to be quite high with an R^2 of 0.894, and an adjusted R^2 of 0.872. This means that about 87 percent of the variances in property price are explained by the variables included in the model (see Figure 1).

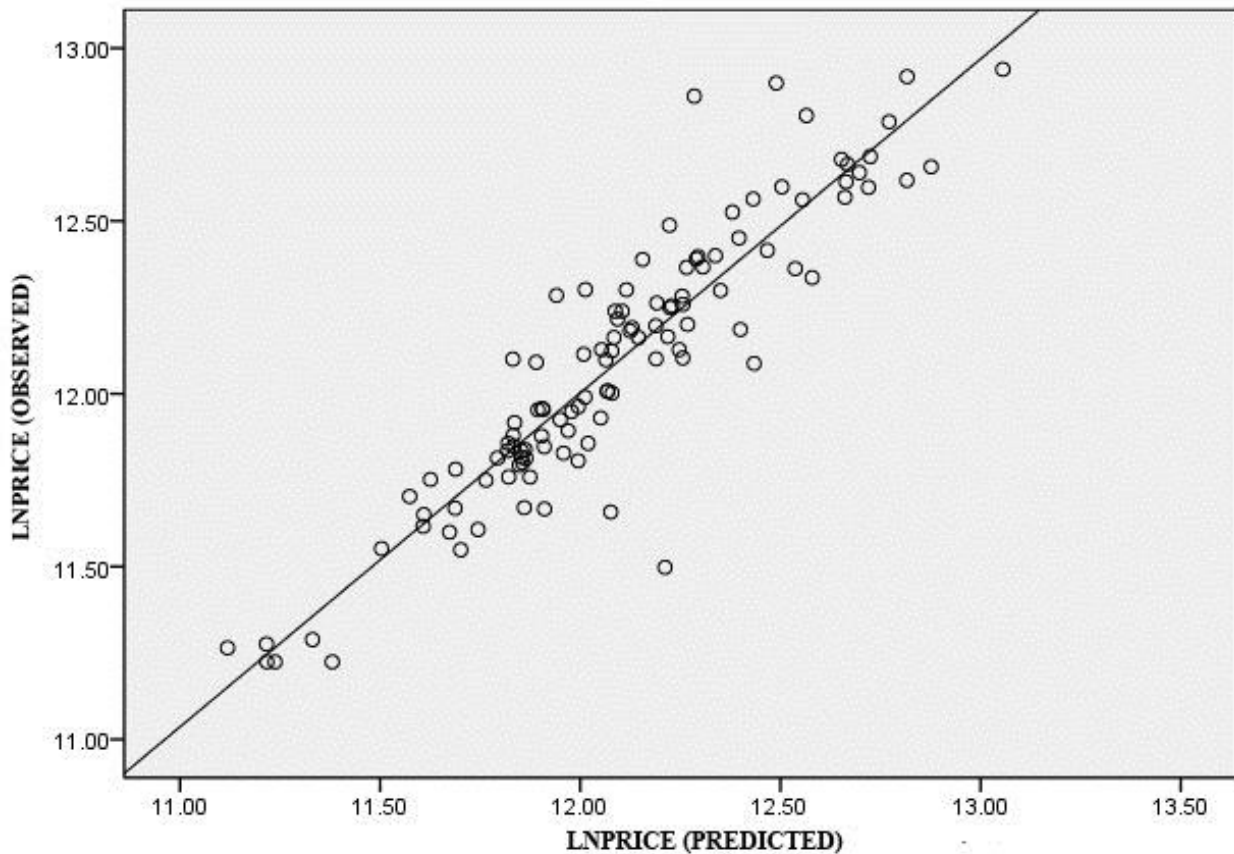

Figure 1: Scatter plot of observed and predicted values of LNPRICE

The F-value of the model was found to be 30.906 which is statistically significant at less than the 0.0001 level. It indicates that the model as a whole accounts quite well for the behavior of the predictor variables.

The independent variables belonging to physical attributes group that had a statistically significant positive relationship with property price were built-up area, bathrooms, and neighborhood at the levels of significance 0.000, 0.005, and 0.000. The neighborhoods that were found to be statistically significant at the level of 0.05 were Breezy Heights in College Station, and College Hills Estates, College Hills Woodlands, Culpepper Manor, Lakeview North, North Garden Acres, and The Oaks in Bryan. The coefficients for built-up area and bathrooms were positive. That means any increase in built-up area or number of bathrooms has a consequent increase in the value of the dwelling. The one neighborhood in College Station with a statistically significant relationship to the value of a dwelling had a positive coefficient. All the neighborhoods in Bryan with a statistically significant relationship to the value of a dwelling had a positive coefficients. It can be inferred from this observation that keeping all other variables constant, dwelling values are higher in College Station than those in Bryan.

The reason for the number of bedrooms as not being identified as a predictor of property price is probably because the total built-up area also acts as a proxy for this variable. It is also possible that a dwelling with a lower number of bedrooms may have a higher built up area, if the bedroom sizes are large. Looking at the neighborhoods with a statistically significant relationship with value, it may similarly be inferred that neighborhood acts as a proxy for town. This may be the reason why the effect of town was not identified as statistically significant.

The results also suggest that at least one of the curb appeal variables, territorial markers, has a statistically significant relationship with property price at a p-value of 0.037 level. It is reassuring to find that it remains significant even in the presence of the physical attributes of a single family dwelling.

5. CONCLUSIONS

There are many factors that affect property value of a single family dwelling. They include both physical characteristics and quality attributes of a dwelling. The purpose of this study was to find out empirically the effect of both physical and environmental attributes of a single family dwelling, located in two neighboring cities in Texas, on its value.

The results of the study provide support to the hypothesis that property values of single family dwellings are affected by both physical and environmental attributes. Built-up area, bathroom, and location have been identified as predictors of property value for the sample population.

At least one of the measures of curb appeal, territorial markers, was found to have a statistically significant effect on property values in the presence of physical attributes of single family dwellings. The other measure, level of maintenance of private outside spaces, did not remain significant in the presence of other predictors of property price.

This study was limited to four residential neighborhoods in a university town in Texas, using a sample size of only 112 single family dwellings. In view of the small sample size, the findings of the study should be viewed with caution. Use of a larger sample size is advisable for future research in this area.

6. REFERENCES

- Beard, J. B. & Green, L. R. (1994). "The role of turfgrasses in environmental protection and their benefits to humans." *Journal of Environmental Quality*, Vol. 23, No. 3, pp 1-16.
- Behe, B. *et al.* (2005). "Landscape plant material, size, and design sophistication increase perceived home value." *Journal of Environmental Horticulture*, Vol. 23, pp 127-133.
- Cebula, R. (2009). "The Hedonic Pricing Model Applied to the Housing Market of the City of Savannah." *The Review of Regional Studies*, Vol. 39, No. 1, pp 9-22.
- Choudhury, I. & Trivedi, S. (2011). "The effect of private outside space quality on the property value of a residential building." *The American Professional Constructor*, Vol. 34, No. 1, pp 32-38.
- Choudhury, I. (2001). "Qualitative correlates of private outside space satisfaction." *The American Construction Education*, Vol. 6, No. 1, pp 139-145.
- Emrath, P. & Taylor, H. (2011). "Housing Value, Costs, and Measures of Physical Adequacy." Proceedings of the American Housing Survey Users Conference, US Department of Housing & Urban Development: Washington, DC.
- Esajian, P. (2014). "The importance of curb appeal." *Fortune Builders*, <http://www.fortunebuilders.com/importance-curb-appeal/>. Retrieved on September 20, 2016.
- Garskof, J. (2008). "For curb appeal, the asset is grass." *Money*, Vol. 37, No. 9, pp 61-63.
- Lawrence, R.J. (1981). "Connotation of transition spaces outside the dwelling." *Design Studies*, Vol. 2, No. 4, pp 203-207.
- Neumann, B.C. (2005). "Is All Open space Created Equal? A Hedonic Application within a data-rich GIS environment. A Master's thesis, The University of Maine, Orno, USA.
- Romekaew, N. (2001). "Evaluating the contribution of infrastructure effects on residential property." Proceedings of the 7th annual conference of the Pacific Rim Real Estate Society, PRRES: University of South Australia, Adelaide, Australia.

- Rodriguez, M. & Sirmans, C. F. (1994). "Quantifying the value of a view in single family housing markets." *Appraisal Journal*, Vol. 62, pp 600-603.
- Roman Empire Landscaping (2009). "Benefits of well-maintained lawn." <http://relandscaping.com/Well%20Maintained%20Lawn.htm>. Retrieved on March 21, 2010.
- Sander, H. *et al.* (2010). "The value of urban tree cover: A hedonic property price model in Ramsey and Dakota Counties, Minnesota, USA." *Ecological Economics*, Vol. 69, pp 1646-1656.
- Sirmans, G. F. *et al.* (2005). "The value of housing characteristics: A meta-analysis." Proceedings of mid-year meeting of the American Real Estate and Urban Economics Association, AREUEA: Washington, DC.
- van Voorhis, C. R. W. & Morgan, B. L. (2007). "Understanding Power and Rules of Thumb for Determining Sample Sizes." *Tutorials in Quantitative Methods for Psychology*, Vol. 3(2), pp 43-50.

CORRUPTION IN THE CONSTRUCTION INDUSTRY: COMPARISON OF SURVEY RESULTS IN CROATIA AND THE UNITED KINGDOM

D. Glavinja, A. Cerić^a, M-M. Nahod

University of Zagreb Faculty of Civil Engineering

Email: anita@grad.hr

Abstract: Numerous studies of corruption perception around the world have shown that corruption in the construction industry is more prominent than in other industries. A Croatian survey concerning corruption in the construction industry was conducted following the design and methodology of the Chartered Institute of Building (CIOB) in the United Kingdom (UK). The respondents were professionals from different geographic areas in Croatia. A total of 107 respondents were involved in the survey. The main findings are presented together with a comparison between the UK and Croatia. In spite of many differences between the two countries, the survey results are quite similar. According to results all stages of construction process are subject to corruption, but the pre-qualification and tendering phase is the most at risk. The respondents from both countries believe that their professional organisations concerned with construction and governments are not doing enough to suppress corruption in the construction industry. The paper concludes with discussion of anti-corruption measures and approaches.

Keywords: Corruption, Construction Industry, Anti-Corruption Measures, Croatia, United Kingdom (UK)

1. INTRODUCTION

The value of global construction output is expected to increase by \$8 trillion to reach \$17.5 trillion per annum by 2030. It is difficult to determine precisely the value of losses through corruption, but estimates tend to range between 10 and 30% (World Economic Forum, 2016). Corruption in the construction sector is present in both developed and undeveloped countries. Corruption can occur during all phases of a construction project - planning and design, tender, execution, and operation and maintenance (Kwan and Ofori, 2001; Stansbury 2005).

According to Sohail and Cavill (2009) main causes of corruption in construction are overcompetition in tendering process, insufficient transparency in the selection criteria for tenders, inappropriate political interference, complexity of institutional roles and functions and asymmetric information between project participants. Numerous research investigated the sources of corruption (e.g. Zarkada-Fraser and Skitmore, 2000; Liu *et al.*, 2004; Bowen *et al.*, 2012; Robertson *et al.*, 2014). An overview of corruption research in construction is presented in Le *et al.* (2014). Zhou (2006) claims that, a substantial number of participants in construction projects believes that corruption should not be sought only in the processes, but also in state authorities and the absence of ethics in the conduct of the public officials involved in the process. In the past several years, many countries updated their laws. The UK, for example, presented the Bribery Act in 2011; France and Spain added amendments to their regulations; Russia presented new laws with increased fines (Robertson *et al.*, 2014).

Professional construction bodies also joined the prevention of corruption. The Chartered Institute of Building (CIOB) thus conducted two surveys (in 2006 and 2013) on the topic of corruption with the aim of researching “whether construction professional see corruption as a problem in the UK”. American Society of Civil Engineers (ASCE) promoted a “zero tolerance” policy.

So far, no research on the topic of corruption exclusively in the construction sector of Croatia has been carried out. There has been research in the area of the Western Balkans, including Croatia, however not exclusively in connection with construction, but other industries as well. The aim of this paper is to highlight the issue of corruption in the construction sector in the Croatia as well as to encourage further research on this topic. Furthermore, the research will serve as the basis for a wider cooperation between professional associations and the academic community in the prevention of corruption and restoration of the image of the construction industry in Croatia.

The rest of the paper is divided into four sections. The first section outlines the research methodology. The second section presents the main survey results. In this section, the respondents' answers are analysed and compared with the research in the UK. The third section provides guidelines for the reduction of corruption in the construction sector in Croatia. The fourth section presents the conclusions and limitations of this research.

2. RESEARCH METHODOLOGY

For the purposes of the research of corruption, a survey was conducted with the aim of identifying the most frequent problems and causes of corruption in the construction sector in Croatia. The survey was based on the UK research conducted by the Chartered Institute of Building (CIOB, 2013). The survey was conducted using an internet based questionnaire (Glavinja, 2014). The questionnaire was sent by e-mail to addresses of construction companies and professional associations.

The survey was divided into two parts. The first part contained general demographic questions with regard to where the respondents come from, their sex, age, position within the organisation, amount of work experience, and number of employees in their company. The second part of the survey contained questions related to the perception of corruption in the construction sector in Croatia. One question concerned the perception of corruption in the European Union (EU) since Croatia joined the EU several years ago. Most of the questions were designed so that the respondent could choose among multiple answers to the question.

3. SURVEY RESULTS AND MAIN FINDINGS

In total, 107 respondents from all Croatian regions participated in the survey. Most of the respondents (41.2%) work in Zagreb, the capital city, while others come from other regions of Croatia. Around two thirds of the respondents are male, and almost half of them are aged 31-40. A majority of them (81%) are employed within their company, while 19% are employers.

Thirty nine percent of the respondents have up to five years of work experience in construction, 37% of them have 5-10 years of work experience, while 24% have more than 10 years. Around 70% of the respondents work in smaller companies with up to 50 employees, while around 14% of them work in companies with over 200 employees.

The questions and the respondents' answers are given below. Due to limited space, only the most significant results are presented.

Q1: How common do you think corruption is within Croatia construction sector?

The results show that 90% of respondents believe that corruption in the construction sector in Croatia is a very frequent or frequent occurrence. When that result is compared to the result of the research conducted by the UK CIOB, the result for the same question is markedly different. In UK, 49% of respondents believe that corruption is a very frequent or frequent occurrence in construction.

Q2: What are your perceptions of the following corruption reasons?

The respondents were asked to assess the corruption level of some reasons related to the construction sector. Five most frequent reasons leading to corruption were listed, such as: cultural reasons, economic reasons, lack of anti-corruption policies in organisation, lack of training of anti-corruption policies by staff and long supply chain. The respondents had to state their opinion on whether the reasons mentioned were: frequent, fairly frequent, rare or non-existent.

According to the respondents, the long supply chain is highlighted as the most corrupted; this is the belief shared by almost 85% of the respondents. It has already been mentioned that the long supply chain, related to subcontracting, is one of the areas most sensitive to corruption. For example, the most frequent corruption activities occur in the form of avoiding public tenders or rigging public tenders for a certain contractor, etc.

Moreover, around 80% of the respondents believe that cultural aspects are one of the reasons for the corruption in the industry. In Croatia, the implementation of anti-corruption policies by organisations is still insufficient, which is a good indicator of the lack of education of employers and employees with regard to anti-corruption measures that can be taken in an organisation. Another result of the lack of education is the lack of awareness and implementation of anti-corruption measures by individuals, which is reflected in the result that as many as 70% of the respondents consider it to be the cause of corruption. Organisations should implement more education and training of their employees on the issue of corruption, but also on the methods and measures for preventing it, warning them of possible corrupt practices. Nearly 70% of the respondents believe that it is the economic reasons that lead to corruption (see Figure 1).

By comparing the results obtained in this research with the research carried out by the UK CIOB, it can be concluded that UK respondents believe that the cultural reason is the main cause of corruption. The economic reason comes second and is followed by the long supply chain and anti-corruption policies by organisation.

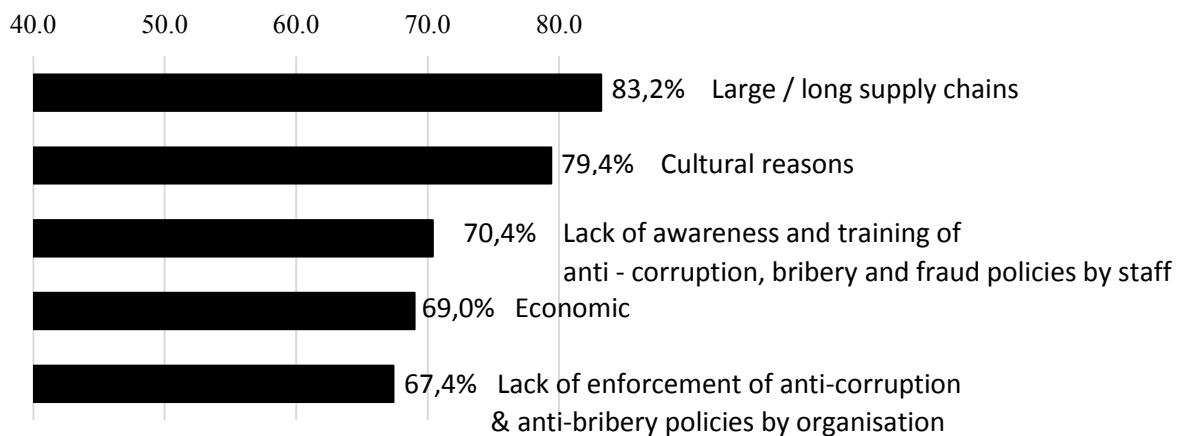

Figure 1: Corruption reasons

Q3: Do you believe that the use of gifts and corporate hospitality can be treated as bribery?

Most of the respondents (around 60%) consider the use of gifts and corporate hospitality to be acceptable as long as they are reasonable and not overly extravagant. The results are quite different from the results obtained in the UK, where as many as 67% of the respondents consider the use of gifts and corporate hospitality as a form of bribery and corruption. The consensus is that the use of gifts and providing entertainment, lunches and similar events belongs to the grey zone of business.

Q4: At what stage of the construction process do you believe corruption is most susceptible?

According to the UK research, most of the respondents believe that all of the main phases of a construction project are equally susceptible to corruption. The pre-qualification and tendering phase share almost the same percentage (35%) according to the UK and Croatian respondents. Furthermore, the Croatian respondents believe that the project execution phase often involves corrupt practices (see Figure 2). For example, a deal between the contractor and site manager to accept a poorer quality of materials, or construction below the prescribed standards, or manipulating the number of work hours, etc..

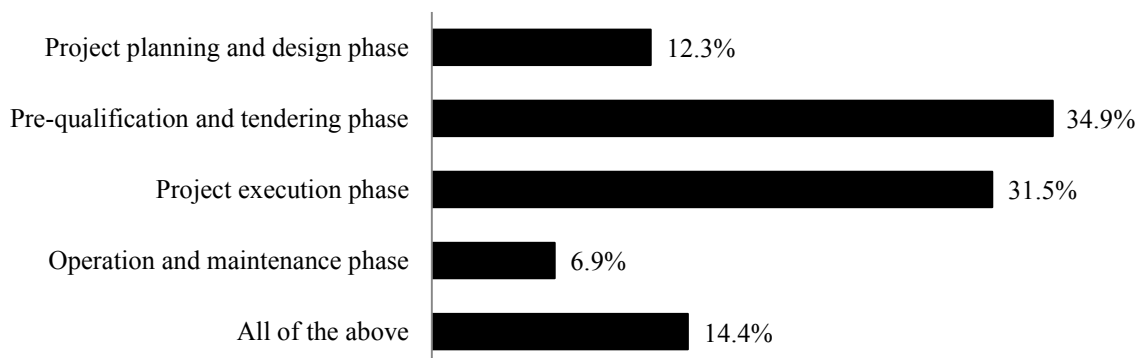

Figure 2: Perception of respondents in Croatia concerning the question which phase of a construction project is the most susceptible to corruption

Q5: Have you personally ever come across cartel activity in the Croatia construction sector?

Over a third of the respondents both in Croatia and the UK said that they had encountered a cartel activity in the construction industry at least once. A larger percentage said that it had happened multiple times. Out of the number of respondents who said that they had witnessed a cartel activity, around 36% of them indicated that it had last happened in the previous 12 months (see Figure 3), which suggests that there are cartel activities currently in the construction sector.

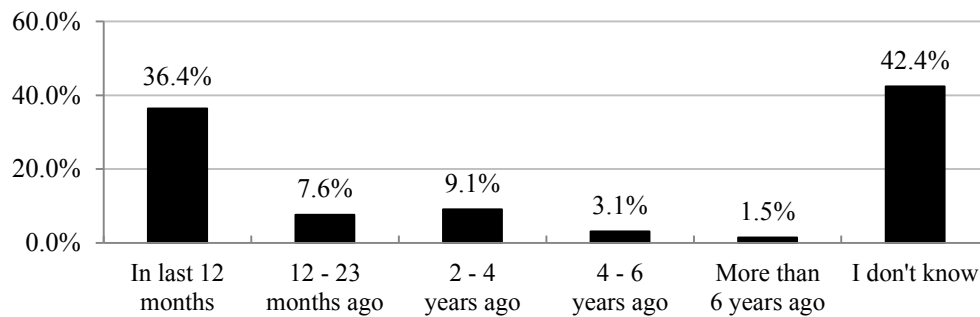

Figure 3: Perception of respondents' cartel activity in Croatian construction industry: the last time of coming across cartel activity in the construction industry

Q6: Have you ever been offered a bribe or incentive to engage in a corrupt practice?

Even though a relatively small number of respondents, around 30%, claimed that a bribe or incentive to engage in a corrupt practice had been offered to them at least once personally, this indicates that anti-corruption laws actually work. These figures can relate only to “direct” acts of bribery, without taking into consideration other payments benefits that can be considered to be normal practices and customs, and not bribery. The results from the UK survey are quite similar to the results obtained from the Croatian respondents, with a somewhat smaller percentage of those who did not give an answer.

Q7: Does your company have a systematic or procedural option to report corruption?

While most of the respondents in Croatia, as many as 53% of them, claim that their company either does not have that option or that they are not acquainted with it, 60% of the UK respondents are aware of such options. Only a fifth of the respondents in Croatia claim otherwise, and slightly over 8% of respondents took advantage of such options, pointing to different outcomes. Only 11.5% of them claim that they know of such options in their organisation, but that they have never used them.

However, 13% of those respondents in the UK have used those options, while 87% of them have not. In Croatia, even though a substantially smaller percentage said that their company offered such options, just over 40% of respondents have used them, leading to the conclusion that people in Croatia are less reluctant to use such options than people in the UK.

Q8: Are you aware whether your company has training and procedures in place to prevent bribery and corrupt activity?

A large percentage (nearly 58%) of the respondents claims that their company has not defined such procedures (see Figure 4). The survey shows that, in a large number of cases where the answer is “No”, most of those respondents are employers. There are large differences when the results are compared with those from the UK. Namely, 57% of the UK respondents are acquainted with such procedures, which are an indicator of the use and application of such practices in the developed countries of the Western world, while in Croatia it is still only the future in the fight against corruption.

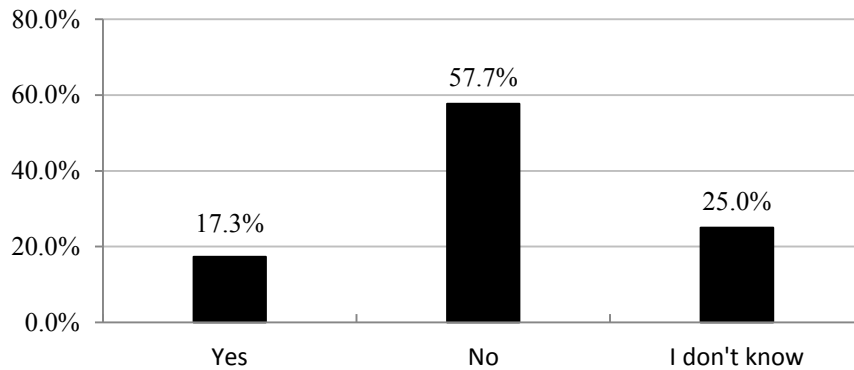

Figure 4: Perception of respondents in Croatia concerning the existence of corruption prevention activities

Q9: How important do you believe is to tackle the issue of corruption?

The results in both Croatia and the UK show that over 90% of respondents believe it is very important or important (see Figure 5). In both developed and developing countries, corruption disrupts market integrity and slows down economic growth. Even though there is a combination of political and public will to stem corruption, there is no universal cure for it. Each country and industry faces its own set of challenges, seeking an individual and tailor-made approach for each case.

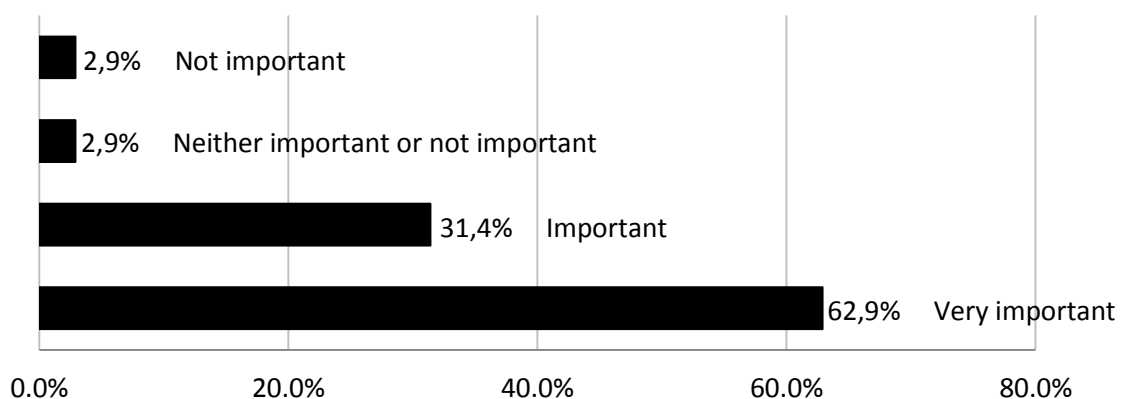

Figure 5: Perception of respondents in Croatia concerning the importance to tackle the issue of corruption

Q10: Do you think is there any change regarding corruption activities in Croatian construction sector since joining EU?

Most of the respondents believe that the accession of Croatia to the European Union did not reduce the scale of corruption in the construction sector at all (see Figure 6). However, another good indicator is that less than 1% of the respondents believe that the scale has broadened. On the other hand, a respectable percentage (22%) believes that the scale has been reduced.

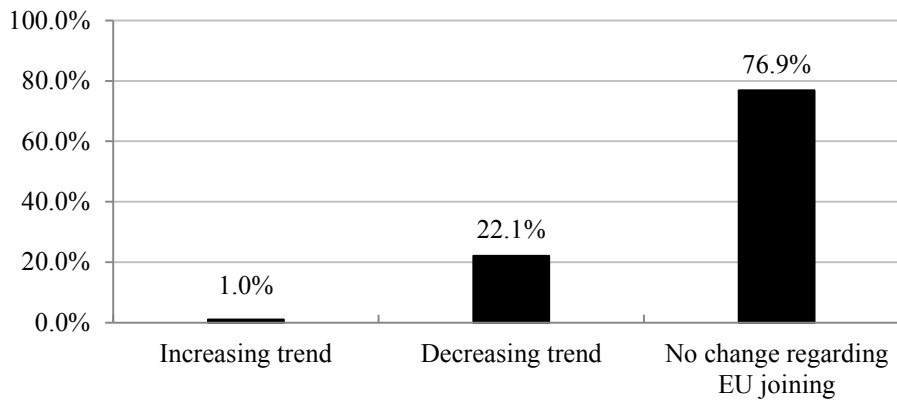

Figure 6: Perception of respondents in Croatia concerning the corruption after joining EU

Q11: Do you think that construction industry or government is doing enough to prevent corruption?

Over 90% of respondents consider that neither the construction industry nor the Government of Croatia is doing remotely enough to prevent corruption. As many as 93% of respondents believe that the Croatian Government should seriously tackle corruption and assess the damage it is causing in both the economic and social sphere (see Figure 7). The research conducted by Transparency International concludes that the lack of information on corruption in different industries restricts the options of the Government and its agencies to address its prevalence.

Generally speaking, the respondents in the UK also believe that their construction industry and Government are not doing enough to prevent corruption. Still, around 20% of them consider that their efforts show that they are doing enough, which is a considerably higher percentage than in Croatia.

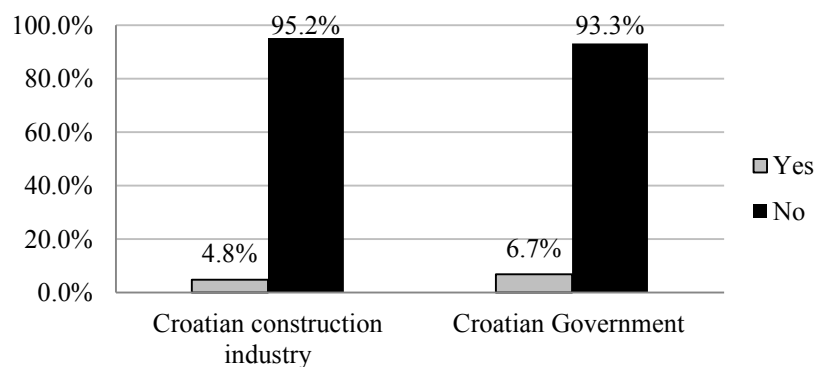

Figure 7: Perception of respondents in Croatia concerning whether the construction industry and government are doing enough to prevent corruption

Q12: At what level do you think corruption is most likely to occur?

Corruption on the corporate level is more likely than on the individual level. As many as 70% of respondents are of the opinion that the local government is the most likely level at which corruption will occur and 60% of them believes that it occurs at the level of the state government as well (see Figure 8). The UK respondents however, consider that corruption is most likely to occur at the individual level. Like the Croatian respondents (54 %), they find that it is most likely to occur at the senior management level.

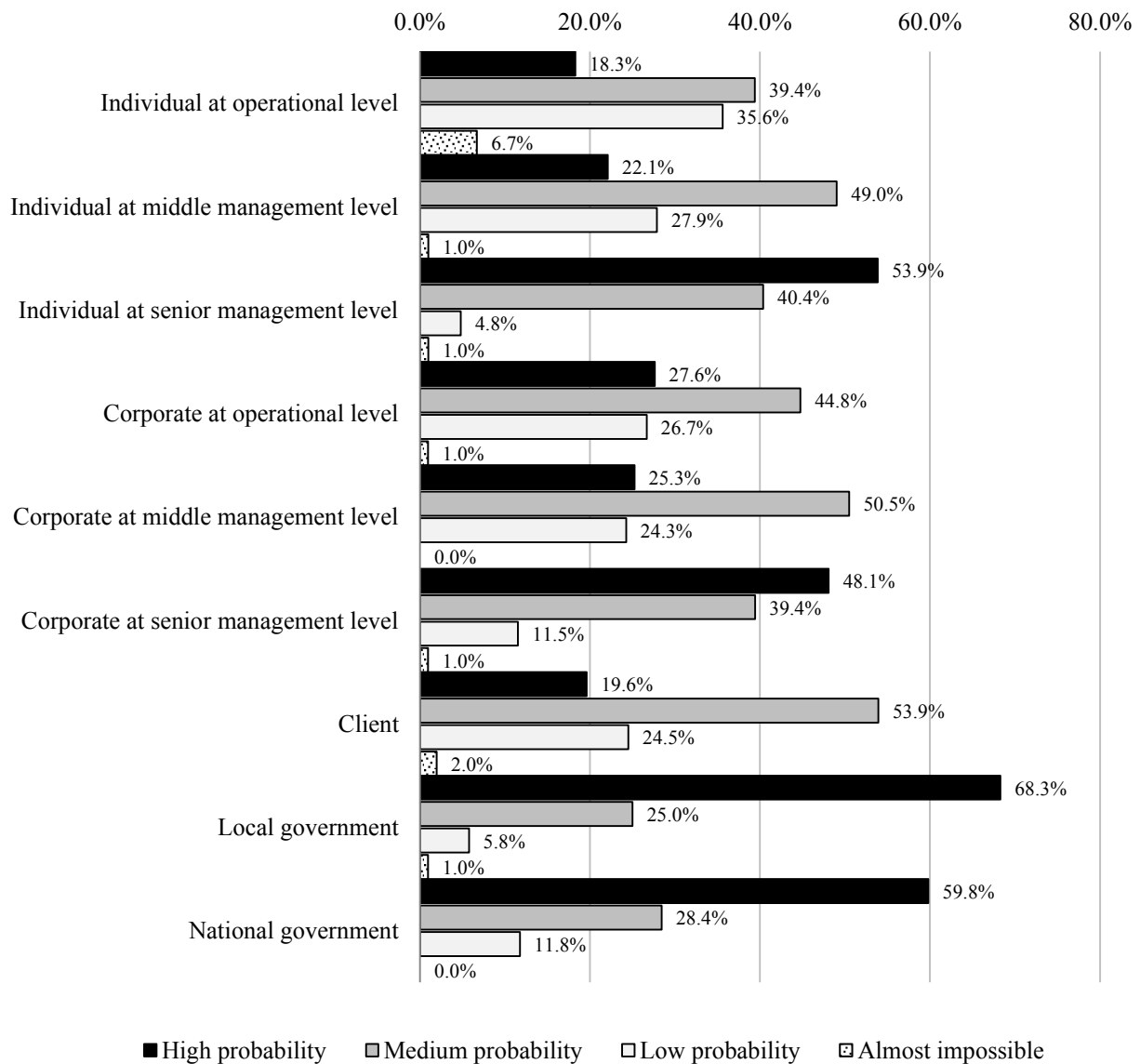

Figure 8: Perception of respondents in Croatia concerning the level on which corruption occur

Q13: How often do you think the aforementioned public servant is bribed in the construction sector?

Over 80% of the respondents believe that, in the construction sector, civil servants from the Ministry often accept bribes. Slightly less than 80% of them consider that Government

ministers and members of the Parliament also accept bribes often or very often. They are followed by public servants at the local levels – municipal or county public servants or elected representatives, for which approximately 75% of the respondents believe that they accept bribes very often or often. It is interesting to note that at least 60% of the respondents said that nearly every one of the aforementioned public servants accepted bribes very often or often.

Q14: To what extent do you find a certain activity acceptable?

Most of the respondents (79%) find using connections and personal contacts in public institutions to speed up procedures acceptable. Moreover, in cases of obvious violation of ethical standards, at least a third of the respondents think that performing multiple public functions simultaneously is an acceptable activity, while around 20% of them think that using public funds for the interests of third parties and performing a public function with a simultaneous existence of interest in a private company – i.e. a conflict of interest – are acceptable activities.

When the results obtained are compared to the answers to the same question posed by the United Nations Office on Drugs and Crime (UNODC) to respondents in the Western Balkans, including in Croatia, it can be said that the results obtained are similar, with perhaps a slightly smaller scale of percentage, but with generally the same proportion (UNODC, 2014).

Q15: What do you think about corruption in other Member States of the European Union?

The last question asked the respondents to compare the status of corruption in Croatia with the average corruption status in other Member States of the European Union. Almost two thirds of the respondents believe that corruption is more pronounced in Croatia. A quarter of the respondents find that the corruption in Croatia is the same as in the rest of the European Union.

Croatia on the Corruption Perception Index, carried out by Transparency International (2017), is 55 out of 100, where 0 is the most corrupt, and 100 is the least corrupt. Other Member States of the European Union generally attain higher results than Croatia. Only Italy, Romania, Bulgaria and Greece have worse results which indicate that Croatia is actually below the EU average. It can be said that the result of this question is essentially correct and that, according to that fact, corruption is more pronounced in Croatia than in other Member States of the European Union with regard to its average.

4. GUIDELINES FOR THE PREVENTION OF CORRUPTION IN THE CROATIAN CONSTRUCTION SECTOR

Guidelines for the prevention of corruption in the Croatian construction sector should concern three levels: the level of the state, the level of professional associations, and the level of companies.

At the state level, the issue of corrupt civil servants has been pointed out. Greater transparency could contribute to the reduction of corruption to a significant extent. According to Sohail and Cavill (2008), promoting higher transparency with regard to activities carried out by civil servants discourages them from getting involved in corrupt transactions. Moreover, it raises citizens' awareness of the goods and services they should receive.

It is evident that some corrupt practices are considered to be very acceptable in business, such as speeding up processes through contact, which is a good indicator of the fact that the Croatian authorities should work on cutting and easing the procedures related to obtaining certain licences. Furthermore, it is also necessary to reduce excess administration and administrative procedures in Croatia.

Companies should take measures to protect themselves from corruption by implementing proactive and comprehensive anti-corruption programmes. It is necessary to carry out adequate measures related to construction site inspections, such as supervising the amount of materials used in construction, and amount of work. Internal financial controls and audit procedures are crucial for the restriction and supervision of financial activities within a company (Robertson *et al.*, 2014).

Education is the key to combating corruption. Understanding that bribery and corruption disrupt the market and reduce profits is a large part of preventing corrupt activities. It is necessary to equip the construction industry with relevant anti-corruption training. According to CIOB (2013), undergoing training should not be perceived as an arduous and expensive process because such programmes have many advantages: a higher profitability, openness to new business, and restored reputation of the construction sector.

Professional associations play the main role in regulating the behaviour of members according to an equal assessment. There are efforts to develop ethical standards for the construction sector. Companies should be thoroughly checked in order to ensure that partners in a joint investment do not abuse their position either on the commercial or state level so as to influence the contract award decision.

5. CONCLUSION

Corruption in the construction industry is a frequent occurrence in most countries. According to the respondents of this survey, the Croatian construction sector also faces serious corruption issues. More than 90% of the respondents believe it is a frequent occurrence in the construction sector. Many respondents claim that there is confusion with regard to the perception of corruption, and these cultural reasons (something that seems corrupt to one person can be a usual practice to another person) are highlighted as frequent reasons for corruption. Furthermore, a large percentage of subcontracting is considered by many to be a usually frequent source of corruption, along with the economic difficulties that the construction sector in Croatia is currently suffering.

With regard to frequent construction practices, the respondents find the contracting process to be the activity which is the most susceptible to corruption. A large number of them declare revealing information to authorised bidders corrupt. Moreover, they believe that corrupt practices often occur in connection with recording the amount of work. The respondents believe that corruption is more likely to occur at the senior management level, nearly 70% of them think that it is likely to occur at the local government level, while 60% of them suspected the state authority level.

The small number of survey respondents is a limitation of this study. However, the fact that this research represents the first research in Croatia on the topic of corruption in the construction sector makes it relevant. As was mentioned at the beginning, the authors hope that

this overview of the research results will stimulate further research of corruption in the construction sector, and encourage more people to participate in such research.

6. REFERENCES

- Bowen, P. A., Edwards, P. J., and Cattell, K., 2012, *Corruption in the South African construction industry: A thematic analysis of verbatim comments from survey participants*, Construction Management and Economics, Vol. 30. No. 10, pp. 885-901.
- The Chartered Institute of Building (CIOB), 2013, *Report Exploring Corruption in the UK Construction Industry*, Ascot Berkshire, United Kingdom.
- Glavinja, D., 2014, *Master thesis: Perception of corruption in construction industry (Percepcija korupcije u građevinskoj industriji)*, Faculty of Civil Engineering University of Zagreb.
- Kwan, A.Y. and Ofori, G., 2001, *Chinese culture and successful implementation of partnering in Singapore's construction industry*, Construction Management and Economics, Vol. 19, No. 6, pp. 619-632.
- Le, Y., Shan, M. and Chan, A. P.C., 2014, *Overview of Corruption Research in Construction*, ASCE Journal of Management in Engineering, Vol.30, No.4.
- Liu, A. M., Fellows, R., and Ng, J., 2004, *Surveyors' perspectives on ethics in organisational culture*, Engineering Construction Architecture Management, Vol. 11, No. 6, pp. 438-449.
- Robertson, E., Atherton, L., Moses, D.G., 2014, *Biggest Risk of Corruption in The Construction Industry: The Global Picture*, K & L Gates, London.
- Sohail M. and Cavill S., 2009, *Accountability to Prevent Corruption in Construction Projects*, Journal of Construction Engineering and Management, Vol. 134, Issue 9, pp. 728-738.
- Stansbury, N., 2005, *Exposing the Foundations of Corruption in Construction in Corruption in Practice*, Transparency International Global Corruption Report 2005, Transparency International: Berlin, Chapter 2, <http://archive.transparency.org/publications/gcr/gcr_2005>, visited [05 Mar 2017].
- Transparency International Corruption Perceptions Index, 2017, <http://www.transparency.org/news/feature/corruption_perceptions_index_2016>, visited [05 Mar 2017].
- United Nations Office on Drugs and Crime (UNODC), 2014, *United Nations Convention against Corruption Signature and Ratification Status*, <<https://www.unodc.org/unodc/en/treaties/CAC/signatories.html>>, visited [23 Nov 2014].
- World Economic Forum, 2016, < <https://www.weforum.org/agenda/2016/02/why-is-the-construction-industry-so-corrupt-and-what-can-we-do-about-it/>>, visited [23 Feb 2017].
- Zarkada-Fraser, A., and Skitmore, M., 2000, *Decisions with moral content: Collusion*, Construction Management and Economics, Vo. 18., No. 1, pp. 101-111.
- Zhou, P. X. W., 2006, *Strategies for Minimizing Corruption in the Construction Industry in China*, Journal of Construction in Developing Countries, Vol. 11, No. 2, pp. 15-29.

A DESIGN METHODS APPROACH TOWARDS IMPROVED COST MANAGEMENT OF TRANSPORT INFRASTRUCTURE

M. Mojtahedi¹, S. Newton¹ and F. Tahmasebinia²

¹ Faculty of Built Environment, University of New South Wales, Sydney, 2052, Australia

² Faculty of Engineering, University of New South Wales, Sydney, 2052, Australia

Email: m.mojtahedi@unsw.edu.au

Abstract: Transport infrastructure represents a major investment for any economy. There are not only the direct capital and maintenance costs, but significant indirect costs when such infrastructure fails. Given the increasing propensity for severe and more frequent extreme weather events, especially flooding and significant storm damage, bridges have become a critical point of focus. Design standards struggle to keep pace with the rapid changes in bridge design across the various materials, quality, applied loadings, levels of fatigue, and significance to transport networks each bridge represents. Capital and maintenance expenditure needs to reflect the particular level of resilience required for each individual bridge construction. Conventional cost management techniques recognise that the resilience of a bridge can be expressed as a function of the probability that one or more bridge components will fail given a particular weather event and the period or cost of recovery should such a failure occur. However, current formulations fail to provide a methodology that is sufficiently simple and robust for use by infrastructure planners, operators and regulators to evaluate a multitude of bridges on a regular basis. This study presents a new approach to modelling the resilience of transport infrastructure based on linear and non-linear multiple regression equations. The model predicts the resilience of individual bridges and can be expanded to include the broader cost and other implications of proactive versus reactive flood risk management for transport infrastructure. The equations adopt a design methods framework and reference the probability and known impact of previous weather events along with the probability and aggregated costs of bridge repair work to estimate an optimum resource expenditure balance between risk mitigation, preparedness, response and recovery. The methodology has broad application across any multi-criteria decision-making problem.

Keywords: Additive Models, Cost Management, Flood Risk Resilience, Risk Management, Transport Infrastructure

1. INTRODUCTION

The frequency of extreme flood events in Australia has increased dramatically over recent years, and consequently the economic loss associated with flood events has ballooned (Guha-Sapir et al., 2011). Like many countries globally, Australia is now highly susceptible to flood damage. For example, recently in 2017, Cyclone Debbie created major floods in Queensland with devastating impact. The storm killed at least twelve people, primarily as a result of extreme flooding, and transport infrastructure was inundated across the state (ABC News, Retrieved 8 April 2017). Flooding was also the cause of damage to 15,000 kilometres of road and rail network and approximately 100 significant bridges and culverts in 2011 (Setunge et al., 2014).

Research into the risk management of extreme weather events has tended to focus on the cost consequences of impact and response rather than factors such as resilience (Blong, 2004, and Mojtahedi et al. 2017). Certainly, no research has been found that examines the factors that might influence the resilience of transport infrastructure more specifically, or the particular impact of flooding on transport infrastructure in Australia (Pritchard, 2013). Transport

infrastructure is of special significance because it also serves a critical role before, during and after flood events to reduce the vulnerability of the community more generally. The problem is complex, however, because the vulnerability of individual transport infrastructure will vary by context, depending on factors such as population, elevation, network criticality, maintenance and age (Meyer, 2008).

In any transport network, bridges are often the most vulnerable elements because of their susceptibility to catastrophic collapse (Meyer, 2008, IPCC, 2012). Most bridges in Australia are constructed over rivers, and the most common form of flooding in Australia is river flooding (AGO, 2006). It is essential for effective flood risk management to identify bridges that may be vulnerable to flood events and to mitigate those associated risks. Risk mitigation is aimed at increasing the resilience of transport infrastructure, and the costs of mitigation must be weighed against the benefits offered by increased resilience to the cost consequences of flood damage.

A recent analysis of current design standards for bridges concludes that standards have struggled to keep pace with the rapid changes in bridge design across the various materials, quality, applied loadings, levels of fatigue, and significance to transport networks each bridge represents (Mohseni and Setunge, 2016). At the same time, other studies have shown that the more these factors are considered, the greater the complexity of the design models that tend to result and the less practical the guidelines and standards become (Aflatooni et al., 2013). This has had particular impact on the budgeting of capital and maintenance expenditure, because each individual bridge warrants a unique cost management response.

The genuine complexities associated with analysing the flood risk of individual bridges has resulted in a relative neglect of mathematical evaluation of bridge designs is neglected in previous research. In this study, we review the factors associated with the design of bridges and present a novel mathematical approach to evaluate the relationship between the potential cost impact of bridge damage due to flood risk factors and the cost of mitigation. The equations adopt a design methods framework and reference the probability and known impact of previous weather events along with the probability and aggregated costs of bridge repair work to estimate an optimum resource expenditure balance between risk mitigation, preparedness, response and recovery. The methodology has broad application across any multi-criteria cost optimisation problem.

2. CRITICAL FACTORS FOR RESILIENT BRIDGE DESIGN

When seeking to analyse a complex problem comprising a range of variables the common approach is to apply a parametric regression method. Parametric regression defines a function in which the terms comprise a finite number of unknown parameters derived from numerical data on each of the variables of interest. In the context of transport resilience and risk management, which is highly dependent on the vagaries of individual situations, the variables of interest can vary significantly between situations. In such circumstances, regression is better defined in nonparametric terms across a set of functions. Originally proposed by Friedman and Stuetzle (1981), the additive model method offers a robust and simple to interpret approach to the effect analysis of multiple variables. The additive model takes the form of a familiar regression model, but builds each model from a restricted class of nonparametric regression models. Each nonparametric model uses a one-dimensional smoother to generate linear combinations of the predictor variables in an iterative fashion.

The additive modelling approach provides distinct advantages over alternative nonparametric approaches and is entirely more general than standard stepwise regression procedures (Friedman and Stuetzle, 1981). The additive model approach results in a regression model, but the relationship between each variable and the response is allowed to be flexible and/or linear in nature, as indicated by the following formula:

$$\sum_{j=1}^n f_j(x_j) = \sum_{j=1}^n \beta_j \times x_j^n \quad (1)$$

Where, $f(x)$ represents linear or non-linear relationships between phenomena.

Based on Equation (1), we develop an additive statistical equation for analysing transport infrastructure flood specific to bridge risk-based resilience as follows:

$$r = \alpha + \sum_{j=1}^p f_j(x_j) + \epsilon \quad (2)$$

Where, r is the resilience of a bridge to a flood event, α is the intercept, $f(x)$ is a linear or non-linear function between the response and the relevant indicator, and ϵ is the overall error of the model.

Additive models have the strong properties of linear or nonlinear models in so far as they are in a familiar regression form and easy to interpret, but are superior in that they relax the assumption of a linear (or known nonlinear) relationship in the data. Thus, the additive model approach is not a purely nonparametric method (which is one of the potential limitations of the proposed framework), but does represent an effective compromise between flexibility and simplicity.

To begin to build an additive model the first challenge is to identify the principal components. Choice of the principal component is dependent on the range of candidate components and the availability of data. Nonparametric regression does require larger sample sizes than parametric models because the data must support the development of a model structure as well as supply the model estimates. For the purposes of this study, a representative set of eight principal components is used. However, the same framework and approach can be applied to an unlimited number of principal components where relevant data is available. Based on a broad review of the literature, the following eight principal components are used in this study of bridge resilience in the context of flood risks:

- X₁:** Peak Flood Discharge (PFD)
- X₂:** Likelihood of a flood event, represented by the Annual Exceedance Probability (AEP)
- X₃:** The size of the storm area
- X₄:** Scale of a flood event represented by the Probable Maximum Precipitation (PMP)
- X₅:** Structural integrity of the bridge, represented by the structural age of the bridge
- X₆:** The corresponding risk of collapse
- X₇:** Mechanical properties of the local soils
- X₈:** Factor of bridge safety

R: Resilience of the bridge

2.1 Peak flood discharge

Peak flood discharge is the maximum discharge occurring during a flood event. In hydrology, discharge is the volume rate of flood flow that is gone through a given cross-sectional area. It includes any suspended solids (e.g. sediment), dissolved chemicals, or biologic material (e.g. diatoms) in addition to the water itself (Buchanan and Somers, 1969).

2.2 Annual exceedance probability (AEP)

There are two ways of expressing the likelihood of occurrence of a flood event: Annual Exceedance Probability (AEP); and Average Recurrence Interval (ARI). AEP is the probability of a flood of a given or larger size occurring in any one year, usually expressed as a percentage. For example, if a peak flood discharge of 300 m³/s has an AEP of 10%, it means that there is a 0.10 probability (that is one-in-10 chance) of a 300 m³/s or larger event occurring in any one year. The concepts of AEP and ARI are used to express the probability of rare events such as extreme flood events (Coles 2001 and Haigh et al. 2014). It is crucially important that the AEP of flooding is measured accurately as it is used to inform the risk-based flood management, engineering, resilience and future land-use planning of transport infrastructure (Haigh et al. 2014).

2.3. Probable maximum precipitation (PMP)

World Meteorological Organisation defined Probable Maximum Precipitation (PMP) as "...the theoretical maximum precipitation for a given duration under modern meteorological conditions." (Kunkel et al., 2013). PMP is specific to a given storm area at a particular location at a particular time of the year, with no allowance made for long-term climatic trends. PMP has been widely used for the design of major flood protection works. Typically, PMP is used to estimate the largest flood that could occur in a given hydrological basin, the so-called probable maximum flood (PMF) (Koutsoyiannis, 1999). Probable maximum precipitation (PMP) is the greatest accumulation of precipitation for a given duration meteorologically possible for an area and it is a very important factor for the design framework of resilient transport infrastructure.

2.4. Structural age of the bridge

The structural integrity of a bridge is an obvious and critical consideration in any risk assessment. Structural integrity is directly influenced by the age of the structure, but the influence is different for different construction materials. Given the rich mix of materials used in bridge construction in Australia, and especially the preponderance of heritage bridges, a mathematical relationship between bridge structure age and the resilience of the bridge against flooding is developed. The structural age of a bridge is highly dependent on the structural materials used (Holdsworth and Strachan 1988). A range of materials and combinations of material are possible. For the purposes of this framework the materials to be considered include: brick, mortar and cast iron.

2.5. Mechanical properties of the soils

Determining the mechanical properties of local soil conditions as along with the level of pore pressure is a significant consideration in most current statistical simulations of bridge design. Given n layers of different soils, the simulated values for both horizontal and bending stresses across different layers can be calculated using a linear strain distribution between soil sections (Greenwood and McKenzie, 2001).

3. A NUMERICAL EXAMPLE

A typical steel bridge, including composite deck and deck truss, is considered in order to illustrate the development of an additive model for the cost optimisation of resilient design (see Figure One).

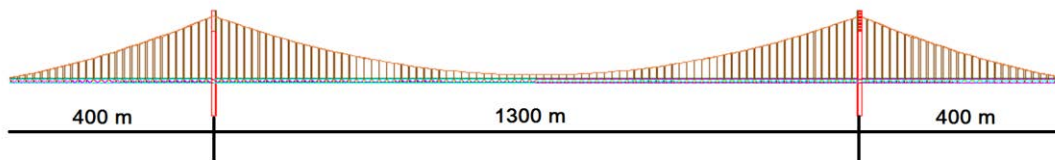

Figure 1: A typical suspension bridge

For this example, the main span is taken as 1,300m, with 400m smaller spans at either end of the main span giving a total span of 2,100m. The deck truss structure is taken as 8.0m in height by 29.5m in width. The deck itself is taken as a 32MPa concrete construction, with a pavement thickness of 0.3m. A modern cable suspension bridge design is also presumed, where the main suspension cable is connected to the deck structure with a series of hanger cables. In all, there are 331 hanger cables, each with a diameter of 0.3m. The main suspension cable in this model is then calculated at 4,334m in length, using a 1.2m diameter cable. This element is closely modelled to the structural design shape using the Catenary Curve Function (CCF). The CCF provides coordinates for each of the nodes on the cable and deck and enables a realistic model of an actual structure to be constructed.

We then use the following equation to estimate the shape of the main cable in our model:

$$y = a \times \cosh\left(\frac{x}{a}\right) \quad a = \frac{\rho g A}{T} \quad (3)$$

Where, y is the y coordinate, x is the x coordinate, T is the tension force in the cable, g is the acceleration due to gravity, A is the area of the cable and ρ is the density of the cable. The value of T is calculated by dividing the prestressing pressure (5MPa) by the cross section of the hanger cables.

We have assumed five different flood risk and meteorological scenarios for the design of this particular bridge by considering the five models shown in Table One:

Table 1: Five scenarios for designing a resilient bridge

Bridge design variable	Model 1	Model 2	Model 3	Model 4	Model 5
PFD (m ³ /s)	100	200	300	400	500
AEP	0.23	0.26	0.27	0.29	0.30
The size storm area	10	20	30	40	50
PMP	0.029	0.058	0.086	0.11	0.144
Bridge Structure Age	1	2	3	4	5
Collapsing risk respond	0.0001	0.003	0.007	0.013	0.02
Strength of the soil (MPa)	0.1	0.2	0.3	0.4	0.5
Factor of bridge safety	1.44	1.56	1.72	1.78	1.80

As there is a quadratic relationship between the flood risk response and the relevant indicator, the relevant coefficient is determined using a nonlinear regression. For the purposes of this study eight independent variables and one dependent variable were considered, with the resilience of the bridge (R) representing our dependent variable. Pearson's Correlation Coefficient was then used to measure the relationship between these variables. Pearson's Correlation Coefficient lies between -1 to +1, where a coefficient of +1 indicates a perfect positive correlation, a coefficient of -1 indicates a perfect negative correlation, and a coefficient of 0 indicates no linear relationship at all. The relevant Pearson's Correlation Coefficient was generated using R statistical software (<http://www.r-project.org/>).

The relationship between the bridge design variables associated with flood risk management and resilience indicators is shown in Figure Two.

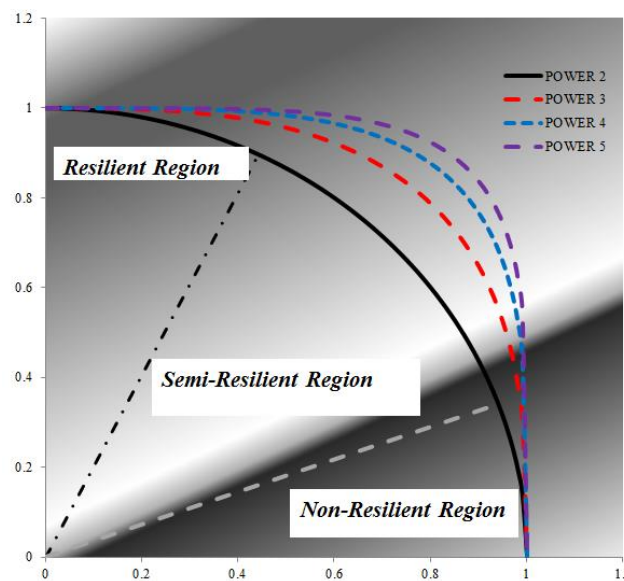

Figure 2: The interaction between design variables and bridge resilience

Interaction diagrams such as Figure Two can be read in combination with other indicators to graphically determine the resilient and non-resilient (as a critical condition) design options. Figure Two can also provide a reliable tool for non-design experts, such as urban and regional planners or other community stakeholders, to make better-informed decisions on design aspects of bridges in the particular context of flood risk management. Directly from such design guidelines, the appropriate balance of capital and maintenance cost allocations can be more reasonably determined. Figure Two can also provide information about the cost impact of the bridge failure in flood disasters. For example, the outcome of the additive model will help

decision-makers to understand whether the specific bridge is resilient or not. By mapping the bridge resilience index into the Figure Two, we will be able to calculate the expected cost of the bridge damage in flood events, and finally, by cost/benefit analysis, the optimum degree of design variables would be identified. There is a direct relationship between resilience and cost associated with bridge damage in flood events.

4. DISCUSSIONS AND CONCLUSIONS

Many aspects of resilient bridge design are expensive and require specialist knowledge. This is especially problematic for the individual stakeholders charged with assessing the risks associated with natural disasters such as flooding and their impact on the cost management of transport infrastructure. At the local council level, for example, budgeting for flood risk mitigation measures such as more resilient design solutions and increased maintenance regimes must be balanced against the costs/cost savings of responding to and recovering from major flood events. Where the optimum design of an individual bridge is dependent on flood mapping, structural engineering, transport modelling and other specialised expertise, local councils often fail to address mitigation and preparedness options and focus only on response and recovery. A sound assessment of the resilience of each individual bridge under various design conditions, presented in a simple graphical model, would go a long way to improving the risk management of bridges in general and the associated cost management decisions in particular.

The numerical example provided in this study looks only at the resilience of bridge design within the context of flood risks. Based on eight principal components the example shows how the application of non-linear multiple additive equations can be used to resolve an otherwise complex and specialised task into fairly straightforward terms of resilience. The equations used here have followed a design methods framework and can be used to identify the resilient, non-resilient and semi-resilient regions for each unique bridge situation. Additional variables can readily be introduced to the analysis to further constrain the variance possible within such a model. For example, cost factors can be introduced to act as blocking agents that contain the range of feasible solutions. In this way, the cost implications of design and maintenance (proactive) decisions can be promulgated through the risk management assessment as a counter to the (reactive) cost consequences of response and recovery. It is precisely this capacity of an additive modelling approach to accommodate new constraints that enables the design methods approach to offer such potential towards the improved cost management of transport infrastructure.

Cost is only one of the additional variables that an additive modelling approach enables. For example, studies in emergency response and recovery management increasingly emphasise the importance of the psycho-social effects on individuals and the wider community that result from natural disasters such as flooding. A design methods approach, based on an additive modelling analysis, can also be used to determine how floods may affect people in different ways depending upon their health, wellbeing, economic status and other personal circumstances i.e. their personal vulnerability or resilience to flooding. As well as being an important factor in its own right, understanding the relative vulnerability of different communities affected by flooding is another consideration that plays back into the broader benefit cost analysis of flood mitigation works. This design methods approach can therefore also assist in the planning and development of education and awareness, flood warning and response, and a myriad of aspects related to flood risk management. More particular issues,

such as the potential impact of increased runoff resulting from particular planning decisions on particular infill developments, could also be modelled and analysed with relative ease and presented in simple terms using the design methods approach.

Like all mathematical evaluations, an additive model approach is limited by the data available. However, in contrast to previous studies where the genuine complexities associated with analysing the flood risk of individual bridges has resulted in a relative neglect of mathematical evaluation, the design methods framework offers a significant simplification without the need for broad generalisations. Each evaluation model developed using an additive model is particular to an individual context, be that an individual bridge design, individual flood risk assessment, individual cost-benefit analysis, individual community context, and/or individual planning situation. The veracity of the results still depend on the quality and scope of the data, but the demands on data and specialist expertise is hugely reduced.

Conventional risk management techniques recognise that the resilience of a bridge can be expressed as a function of the probability and the period or cost of recovery should such a failure occur. However, current probability and consequence formulations fail to provide a methodology that is sufficiently simple and robust for use by infrastructure planners, operators, regulators or the general public to evaluate individual bridges on anything like a regular basis. In this study, we present a new approach to the development of resilience-based non-linear multiple additive equations that predict the resilience of individual bridges to flood events. The equations adopt a design methods framework and reference resilient, non-resilient, and semi-resilient regions for each individual bridge and bridge situation. The interaction maps used to illustrate this study can be used to inform a variety of decision-making exercises, including cost-benefit studies and effective cost management of risk mitigation, preparedness, response and recovery activities. The additive model methodology has broad application across any multi-criteria decision-making problem.

5. REFERENCES

- ABC News, Retrieved 8 April 2017, <http://www.abc.net.au/news/2017-04-08/queensland-floods-man-missing-mondure-found/8428074>
- Aflatooni, M., Chan, T.H., Thambiratnam, D.P. and Thilakarathna, I., 2013. Synthetic rating system for railway bridge management. *Journal of Civil Structural Health Monitoring*, 3(2), pp.81-91.
- AGO, 2006. *Climate change impacts and risk management*. Australian Greenhouse Office, Department of Environment and Heritage: Canberra, Australia.
- Blong, R., 2004. Residential building damage and natural perils: Australian examples and issues. *Building Research & Information*, 32(5), pp.379-390.
- Buchanan, T.J. and Somers, W.P., 1969. *Discharge measurements at gaging stations* (No. 03-A8). US Govt. Print. Off.,.
- Coles, S., 2001. *An introduction to statistical modelling of extreme values*. Springer: Berlin.
- Friedman, J.H. and Stuetzle, W., 1981. Projection pursuit regression. *Journal of the American statistical Association*, 76(376), pp.817-823.
- Greenwood, K.L. and McKenzie, B.M., 2001. Grazing effects on soil physical properties and the consequences for pastures: a review. *Animal Production Science*, 41(8), pp.1231-1250.
- Guha-Sapir, D., Vos, F., Below, R. and Ponserre, S., 2012. *Annual disaster statistical review 2011: the numbers and trends*. Centre for Research on the Epidemiology of Disasters (CRED).
- Haigh, I.D., Wijeratne, E.M.S., MacPherson, L.R., Pattiaratchi, C.B., Mason, M.S., Crompton, R.P. and George, S., 2014. Estimating present day extreme water level exceedance probabilities around the coastline of Australia: tides, extra-tropical storm surges and mean sea level. *Climate Dynamics*, 42(1-2), pp.121-138.
- Holdsworth, R.E. and Strachan, R.A., 1988. The structural age and possible origin of the Vagastie Bridge granite and associated intrusions, central Sutherland. *Geological Magazine*, 125(06), pp.613-620.

- IPCC, 2012. *Managing the Risks of Extreme Events and Disasters to Advance Climate Change Adaptation: Special Report of the Intergovernmental Panel on Climate Change*, C.B. Field, et al., Editors, Cambridge University Press.
- Koutsoyiannis, D., 1999. A probabilistic view of Hershfield's method for estimating probable maximum precipitation. *Water Resources Research*, 35(4), pp.1313-1322.
- Kunkel, K.E., Karl, T.R., Easterling, D.R., Redmond, K., Young, J., Yin, X. and Hennon, P., 2013. Probable maximum precipitation and climate change. *Geophysical Research Letters*, 40(7), pp.1402-1408.
- Mojtahedi, M., Newton, S. and Von Meding, J., 2017. Predicting the resilience of transport infrastructure to a natural disaster using Cox's proportional hazards regression model. *Natural Hazards*, 85(2), pp.1119-1133.
- Mohseni, H., Tran, H. and Setunge, S., 2016. Optimisation of inspection and maintenance activities for bridge components. In *Maintenance, Monitoring, Safety, Risk and Resilience of Bridges and Bridge Networks* (pp. 199-199). CRC Press.
- Meyer, M.D., 2008. *Design standards for US transportation infrastructure: the implications of climate change*. Washington, DC: Transportation Research Board.
- Pritchard, R.W., 2013. 2011 to 2012 Queensland floods and cyclone events: Lessons learnt for bridge transport infrastructure. *Australian Journal of Structural Engineering*, 14(2), pp.167-176.
- Setunge, S., Lokuge, W., Mohseni, H. and Karunasena, W., 2014, Vulnerability of road bridge infrastructure under extreme flood events. In *AFAC & Bushfire & Natural Hazards CRC Conference 2014*. University of Southern Queensland.

AN EMPIRICAL ASSESSMENT OF THE SOUTH AFRICAN AND UNITED KINGDOM PROPERTY MARKETS

S. Nurick, F. Viruly, K. Michell and L. Boyle

UCT–Nedbank Urban Real Estate Research Unit, Department of Construction Economics and Management, University of Cape Town, Private Bag X3, Rondebosch, 7701, South Africa

Email: sd.nurick@uct.ac.za

Abstract: The paper seeks to identify the key differences between the South African and United Kingdom property markets, with specific focus on the office, retail and industrial sectors. Emphasis is placed on the observation that market structures respond to specific and changing characteristics of markets, which in turn affects the structure of commercial investment funding. The chosen methodology is that of secondary data analysis. The main data sources are from reputable market reports and the Investment Property Databank (IPD/MSCI). The analysis of the data speaks to the structure of the economy, the different property sectors, owner composition, the key financial players in the market, and the current market status. It was found that the structure of the South African and United Kingdom property markets are significantly different. The difference is evident in density, decentralisation, performance and owner composition. Overall the South African property market yielded higher returns in conjunction with a lower level of volatility when compared to the United Kingdom property market.

Keywords: Property Markets, South Africa, United Kingdom

1. INTRODUCTION

In the past two decades there has been increased focus on global property market performance. This is due to accelerated growth in diversified international property portfolios. The South African (SA) and United Kingdom (UK) property markets have offered investors above average returns in comparison to other asset classes in the medium and long-term. As property investments tend to rely on a high level of debt funding, banks and other types of lenders are also closely observing the performance of property compared to other asset classes.

The main purpose of this research was to compare the performance of the SA and UK property markets. It is suggested that the performance of a property market is a function of its characteristics, which in turn influence its resilience to outside economic shocks. In order to gain an appreciation of the contrasting characteristics between the two markets, the paper describes the level of concentration and composition of the market share, the key stakeholders that operate in the SA and UK property markets, the sectorial mix, the geographic spread, and socio-economic factors that influence, and hence impact, the performance of the SA and UK property markets. Thus, this research is conducted within the context of institutional economics, which takes a macro viewpoint of “how the property game is played” in terms of accepted societal rules and norms within the market (D'Arcy and Keogh, 2002). These rules and norms support market transactions and facilitate various stakeholders to achieve their real estate objectives (D'Arcy, 2009).

Lorenz and Trück (2008) identified that economic indicators heavily impact different European property markets. The main indicators that emerged as significant contributors were GDP, the inflation rate, population growth rate, and the change in the unemployment rate. These same indicators contribute to the behaviour of the SA property market, although the combination of these contributing factors appears to be weaker than in Europe. The main difference between

the SA and UK economies is a result of political and socio-economic stability, and the maturity of the respective economies. This influences investor confidence and influences market risk, as SA has the risk profile of an emerging country. SA is a mineral rich economy, defined by a highly skewed distribution of wealth and high unemployment rates. Thus, SA is prone to social challenges that are not encountered to the same degree in the UK. This is highlighted by the contrasting unemployment rates between SA and the UK (26% and 6% respectively). This has a significant impact on the populations' ability to access finance and invest in property (TradingEconomics, 2015). The SA economy is also defined by a rapidly growing middle class coupled with increased urbanisation which continues to underpin the demand for both residential and commercial space.

The global property market is showing signs of improvement (recovery) in the aftermath of the global financial crisis (GFC) that had a direct impact on the returns on all sections of real estate. According to Jones Lang Lasalle (JLL) (2015) buoyant capital markets in conjunction with increased demand for space has resulted in significant projected growth across all the main global regions and property sectors. The research uses secondary data collected by IPD/MSCI. The data serves to indicate market performance of both SA and the UK before and after the GFC. This helps highlight the influence market characteristics have on the performance of the property industry.

Typically, property markets comprise of four predominant sectors, namely: office, retail, industrial and residential. To better identify the characteristics influencing the performance of the property markets it is necessary to breakdown the market into its constituent sectors. The residential property sector has been omitted from this evaluation as the comparative data published by IPD/MSCI relating to the residential sector has not been available for long enough to draw meaningful comparisons.

Ultimately, understanding the unique characteristics that govern the performance of a given property market will reduce the risk for investors by enabling them to make more informed decisions. Furthermore, this knowledge could be used to better insulate vulnerable economies in the developing world from external threats such as the GFC. Since property in SA was the best performing asset class in 2014 (return of 26.64%) (Sanlam, 2015), it is evident that creating a lower risk environment in the property market could have a significant impact on economic growth in South Africa.

2. CHARACTERISTICS AND STRUCTURE OF SA AND UK PROPERTY MARKETS

D'Arcy and Keogh (2002) view the property market as an institution, where a set of formal and informal rules govern the actions of the various property market stakeholders. Changes that occur in the institutional environment that impact the property market take place in legal, economic, social and political spheres. The broad institutional climate will influence the perceptions and expectations of property market stakeholders. Conversely the experiences of stakeholders may impact and lead to a change in the institutional environment (D'Arcy and Keogh, 2002). These formal and informal rules are evident in both SA, and UK property markets. Hence, the research will be viewed through this institutional lens.

The structure of the SA and UK commercial property markets differ as a result of the following factors: the urban density of SA and UK cities; decentralisation; and owner composition. While

the UK urbanisation rate has declined significantly, SA rural-urban migration remains significant and continues to play an important role in the present and expected future structure of the built environment. Additionally, the last twenty years have seen increasing decentralisation away from SA's main CBDs, especially from large corporate entities that typically take out long leases for large floor areas. This move has significantly increased the demand for office and retail space in SA cities. Most urban regions in the UK are still relatively centralised, and have not witnessed the level of decentralisation experienced in SA. Furthermore, the UK property market has remained comparatively unchanged in recent years (Investment Property Databank (IPD), 2015a; 2015b). The structure of the SA property market on the other hand has seen significant change, with specific reference to the rapid growth of the listed sector.

Added to the physical differences between the SA and UK property markets are fundamental differences in informal and formal rules, most notably apparent in commercial lease structures. It is considered standard for a commercial lease in the UK to have a duration that is between ten and twenty-five years with open market rent reviews every five years. This is due to a relatively low inflation rate. UK leases also contain a security of tenure clause, which gives the tenant the right for a new lease on similar terms (accounting for adjustment to rent). Lease structures in the UK do not seem to mirror the tenants' business planning horizons, which is viewed as potentially problematic (Crosby *et al.*, 2003). In SA, commercial leases are structured very differently. The average lease duration is three to five years, where an annual escalation is agreed upon upfront between the lessor and lessee. The escalation clause covers the relatively high inflation rate in SA. Unlike in the UK there is also no guarantee to the tenant that they can renew the lease on similar terms upon lease expiry.

Investors are aware that the different sectors of the property market have differing risk profiles and that they react differently to changing market conditions. According to Yunus (2013) diversification is generally beneficial to property investors. This is due to the fact that property is considered a long-term investment and therefore there is a need from investors to understand the impact of diversification on their property portfolios (Yunus, 2013). The Capital Asset Pricing Model (CAPM) postulates that portfolio risk can be eliminated through diversification (Lorenz and Trück, 2008). It was found that in the European property market diversification is prominent in order to reduce the risk of over exposure to one sector. However, with diversification comes the acceptance that returns will be somewhat capped as European property investors tend to be more risk averse. It was also noted that the residential sector tends to be the driver for changes in demand and supply of the three commercial property sectors (Yunus, 2013).

Le and Ooi's (2012) research focuses on the financial structure of property investment companies in terms of equity and debt opportunities in the market. There is an assumption that property companies operating in countries with well-developed capital markets will have greater access to finance acquisitions and developments. In the UK the majority of property finance is administered by banks (Barkham and Frodsha, 2015). In a developing market such as SA, there is less finance available for speculative investments (Le and Ooi, 2012). It was found that property companies operating in developed markets had greater access to both equity and debt, as there are good opportunities to acquire equity from capital markets as well as secure finance from established financial institutions (Le and Ooi, 2012). It is not surprising that larger property companies with more assets on their balance sheet coupled with the potential for growth tend to take on more debt in their capital structuring (Le and Ooi, 2012). There is always an element of risk associated with lending, and financial institutions in the UK

established that loan-to-value (LTV) ratios cannot be monitored in isolation. LTV needs to be monitored in conjunction with the interest coverage ratio (ICR). The ICR should be greater than 1, and is recommended to be 1.25 in the UK market. The inclusion of the ICR lowers the LTV ratio, thus reducing the risk to the lender (Barkham and Frodsha, 2015).

3. METHODOLOGY

The overarching research method is secondary data analysis. According to Glass (1976) secondary data analysis comprises the re-analysis of data for the purpose of addressing an original research question with different statistical techniques or answering new questions with existing data. This is consistent with Kiecolt and Nathan (1985) who state that secondary data analysis is conducting analysis within an existing data set to answer a research question not originally posed in the primary study. This is due to the fact that many studies contain more data than the principal investigators can analyse effectively, thus resulting in a variety of future projects that make use of same data set.

The main source of data was from IPD/MSCI. The researchers were granted access to the IPD/MSCI online real estate analytics portal, which is linked to the latest global property datasets. The online portal allows for the customised selection of relevant data so that analysis may be conducted between countries/regions and different property sectors. Key UK property related banking data was acquired via reputable annual industry reports, which are produced by the British Property Federation (BPF), the Investment Property Forum (IPF) and De Montfort University. One of SA's main retail banks, which have the largest market share in commercial property mortgages, provided data to allow for analyses between the SA and UK commercial property markets. The data on property markets was split into their respective sectors (with the exclusion of the residential sector) in order to gain a greater insight into the characteristics and factors that affect the different property markets.

4. PROPERTY MARKET DATA AND ANALYSIS

SA commercial property has shown significant growth in terms of investment size and returns, particularly within the listed sector. Correspondingly, attention from investors and (by default) engagement with lenders has increased significantly over the last fifteen years. SA has experienced increased international investment as a result of its successful re-emergence into the international political and economic spheres in the mid-1990s. The post isolation years have resulted in an increase in economic activity culminating in Johannesburg becoming Africa's commercial hub attracting demand from international firms to establish offices, shops and warehouses. Cape Town and Durban, the second and third largest economically active cities respectively, have also shown increased demand from foreign entities, both from major global brands and private start-ups who identified SA as an untapped economy. The economic impact of SA's three largest urban nodes is such that they contribute approximately 38% to the GDP (StatsSA, 2015).

In SA consolidated returns for office, retail and industrial property was 12.9% for 2014 (IPD, 2015b). These returns outperformed other macro economic indicators, such as the prime interest rate and inflation, which is approximately 6.1% (StatsSA, 2015). Investment property, which includes the listed property sector as a major stakeholder, has been generally one of the best performing asset classes in the last decade in comparison to other major investment

options, which include *inter alia*, cash, SA equity, foreign equity, SA bonds, and the foreign exchange market. The UK property market has been relatively strong, partly due to high demand in urban areas. London, Birmingham and Glasgow have traditionally been commercial hubs, not only domestically but also within a European context. Property is constantly in demand in London as it is a densely populated city regarded as a global financial hub (Mitchell, 2014).

A number of external factors need to be considered in order to more accurately compare property related figures between SA and the UK, namely: inflation; the long bond rate; and the prime interest rate. All these factors contribute to contextualising the real value of nominal returns when conducting cross border comparisons. These factors can have varying influences on the different commercial sectors within the SA and UK property markets.

4.1 Owners

The main owners of commercial property in the UK market comprises of: overseas investors (24%); insurance and pension funds (19%); collective investment schemes (16%); REITs and other listed property funds (14%); private property companies (14%); other investors (5%); traditional estates/charities (4%); and private investors (3%) (British Property Federation (BPF), 2014). The majority of SA commercial properties are owned by REITs and listed property funds (62%), while insurance and pension funds (18%), unlisted and private funds (13%), and private investors (7%) own the remaining building stock (BPF, 2014; IPD, 2015b). Figure 1 provides a graphical breakdown of property ownership and comparison of the UK and SA markets.

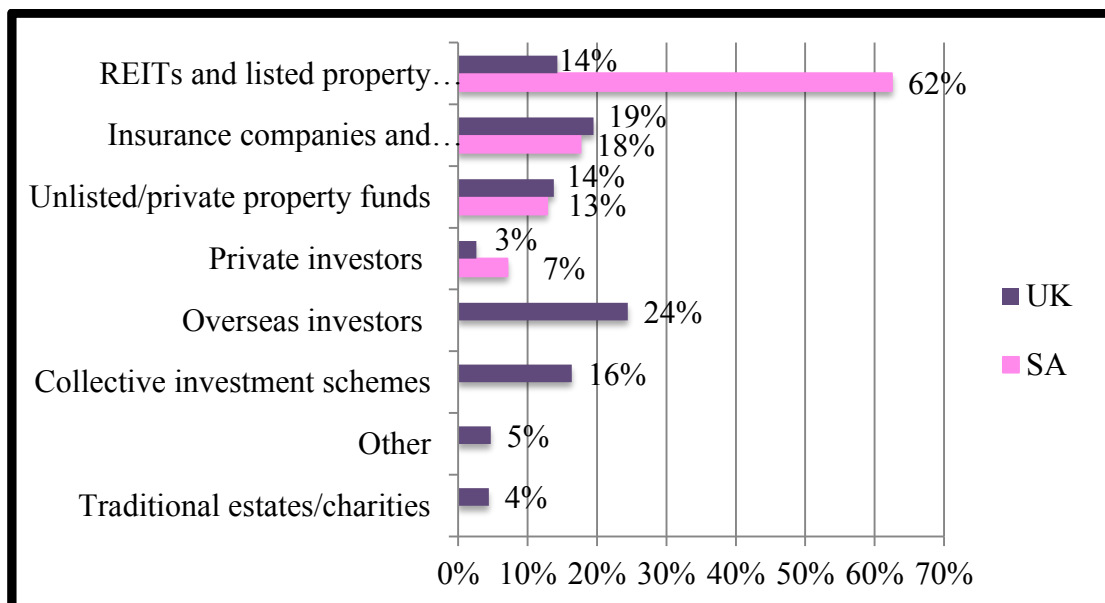

Figure 1: Ownership breakdown of SA and UK property markets (Source: BPF (2014) and IPD (2015a))

4.2 Office

Nominal returns for the office sector in SA and the UK in 2014 are significantly different, yielding returns of 12.08% and 22.66% respectively (IPD, 2015b). The UK market has much

higher returns as it offers a reputable and stable market which provides consistent returns, thus making it attractive for both local and foreign investors. However, the SA office sector continued to operate under sustained pressure from the market due to a range of macro economic factors, the main factor being weak GDP growth. The SA office sector has five and ten year annualised returns of 12.39% and 16.22% respectively, while the UK office sector has returns for the same periods of 13.03% and 7.84% (IPD, 2015a; 2015b).

The main take-up of office space in SA is concentrated on A-grade space or prime property, with specific focus on working environments that offer the benefits of green building features and initiatives (GBFIs). Older buildings, and properties located in secondary nodes are struggling to attract long-term tenants, thus resulting in vacancy rates that are negatively impacting the sectors performance. This can also be attributed to an increase in decentralisation from CBDs to up-market residential nodes by blue chip companies. Office development tends to be focused on high demand, low risk nodes.

Re-developments are on the increase as there is a limited supply of adequate land zoned for office use, which in turn has resulted in above market rentals (Broll, 2014). Despite this, SA's office sector is still very attractive for foreign companies when compared to typical European rentals that range between R220-300/m²/month, and premium London rentals that exceed R700/m²/month (Broll, 2014). The South African Property Owners Association reported an increase in speculative development, thus indicating that there is improved confidence in the office sector. It was also noted that there has been a concentrated increase in demand for office space from the financial services and banking sectors (Broll, 2014).

4.3 Retail

Originally SA's retail property model mirrored the traditional European model, which comprises shops on a high street. Since 1994 there has been a rapid emergence of shopping centres both in historically wealthy suburban areas and large townships. There are currently eight super regional shopping centres in SA, with five of these centres located in Gauteng. There has been significant growth in the retail sector. In 1994 there were 2,616 retail buildings in South Africa, compared to 20,103 in 2014 (IPD, 2015a). Whereas retail properties in the UK have remained relatively constant over the last fifteen years, growing from approximately 3,000 to 3,500 buildings (IPD, 2015a).

Nominal returns for the retail sector in SA and the UK in 2014 are similar, yielding returns of 13.29% and 14.23% respectively (IPD, 2015b). The SA retail sector has performed consistently well in recent years with five and ten year annualised returns of 14.28% and 17.59% respectively, compared to the same figures for the UK retail sector of 9.61% and 5.06% (IPD, 2015a; 2015b). Online retail is making an impact on the SA retail property market, as there has been increased market share with this industry contributing approximately R4.5 billion to GDP. However, challenges around technological infrastructure has meant that online retail in SA has had a smaller impact on the retail property market than it has in the UK (Broll, 2014).

4.4 Industrial

The industrial sector behaves slightly differently to other property sectors. This is partly due to how changes in the economy can affect the timing of the demand for industrial space in

comparison to the demand for office and retail space. Both the SA and UK industrial sectors experienced favourable returns in 2014 of 14.34% and 23.32% respectively. Furthermore, annualised five and ten year returns for the two markets were 14.48% and 19.61% for SA; and 11.26% and 6.54% for the UK (IPD, 2015a; IPD, 2015b). The manufacturing industry in the UK has remained resilient since the GFC. However, the SA industrial property sector has been directly affected by a slowdown in manufacturing output, which resulted in a decrease in GDP growth and a continued weakening of the Rand. A number of sociological, political and economic factors have contributed to negatively impacting the industrial sector, these include: strike action; above inflationary increases in electricity; electricity blackouts during business hours; and a lack of skills in key areas (Broll, 2014).

4.5 Market comparisons

Total index returns are used as a more accurate form of comparison due to the fact that nominal returns are misleading when comparing the SA and UK property markets. Figure 2 shows the consolidated real returns for the SA and UK property markets. The UK property market outperforms the SA market up to 2007, where there is sudden upsurge in the SA market. Unlike the UK market, the SA property market appears to be unaffected by the GFC. This could be due to three reasons, namely: (1) SA banks were prohibited from investing in foreign banks, and therefore their exposure to the collapse of certain financial institutions was limited; (2) SA was awarded the 2010 Soccer World Cup in 2004, which resulted in major built environment and infrastructure projects that were completed during the GFC. These projects kept the SA economy relatively buoyant, which in turn generated benefits that filtered into the property market. Lastly, (3) UK valuers drastically reduced values reflecting the market conditions as a result of the GFC, while their SA counterparts were more moderate when valuing during that period of time.

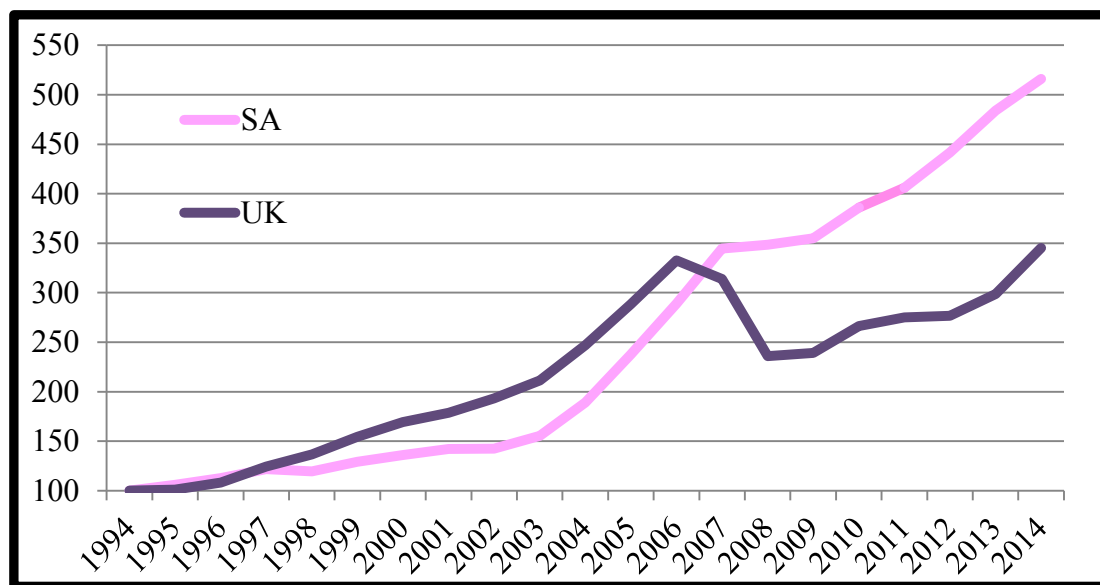

Figure 2: Consolidated real index returns for SA and UK property markets (Source: IPD (2015b))

For the period 1997-2007 the UK's real index was greater than SA. This is due to SA's comparatively high inflation during this period. SA's consolidated total index returns surpassed the UK in 2007 as a result of a boom in the SA property market. The gap between the two

markets increased from 2007 due to the GFC, which resulted in a sharp decline in the UK property market followed by a mild recovery.

4.6 Banking

According to the BPF (2014) the overall level of gearing in the UK commercial property market is less than half of the total current asset value (approximately 44%). Traditionally, finance providers in the UK were banks and building societies. However, since the GFC there has been a wider range of debt sources, including insurance companies, debt funds and foreign banks (BPF, 2014). The level of authorised commercial property finance has decreased year on year since the GFC crisis in the UK. From 2008 to 2013 the loan book experienced an average decrease of 6% per annum (Maxted and Porter, 2013). This highlights UK bank's reluctance to expose themselves to risk following the GFC. This is in contrast to one of SA's main retail banks, which experienced an annualised growth of their loan book for the period March 2014 to February 2015. This is due to the fact that the SA commercial property market did not experience the level of downturn experienced in the UK resulting from the GFC.

In the UK over 57% of new lending in the first half of 2013 was undertaken by six organisations, with 72% of new loans being undertaken by twelve organisations. Of the twelve institutions, only five were UK banks. The remaining seven were foreign financial institutions. The lending breakdown is similar in South Africa where five prominent banks provide the majority of real estate finance. However, there is one significant difference; the SA property market is not exposed to the international banking market (Maxted and Porter, 2013). This disconnection from foreign financial institutions enables SA to be relatively insulated from economic shocks that take place outside the country.

5. CURRENT MARKET STATUS

5.1 Global markets

The current status of the global property market is one of relative optimism, as there is an indication of growth from markets that were heavily impacted by the GFC. Most regions, with the exception of the Europe, Middle East and Africa (EMEA) experienced growth. This is due to an increase in available liquidity, similar to the levels of 2006 that were experienced in the US and Asian markets (JLL, 2015). There has also been a general increase in direct investment since the GFC, which indicates that investor confidence regarding property as an asset class has been continuously improving (JLL, 2015).

5.2 South African market

The SA property market has shown greater signs of volatility since the GFC. The listed sector continues to perform exceptionally well, with returns exceeding 40%. Ungearred property has not been performing to the same level as the listed sector, resulting in relatively large changes in year on year total returns. In 2013 consolidated total returns for the three main commercial sectors were 17.72%, while in 2014 consolidated returns had decreased to 12.9% (IPD, 2015b). The decrease in returns can be attributed to various macro economic reasons that

are unique to SA, such as the value of the Rand in relation to major currencies, and foreign investor confidence. This is influenced by the perception of increased political instability.

5.3 United Kingdom market

The UK market has been moderately volatile, other than during the GFC (2008-2010) where the market yielded negative returns, but recovered relatively quickly. Consolidated returns for all three commercial sectors and the residential market range between 10% to 25% for the period 1994 to 2014. Figure 3 shows that from 1996-2003 the UK property market outperformed the SA market. In 2004 the SA property market started to significantly outperform the UK market, even during the GFC. From 2009-2014 the SA market was relatively stable showing gradual growth. However, the UK market performance was hugely volatile during that same period of time (IPD, 2015a).

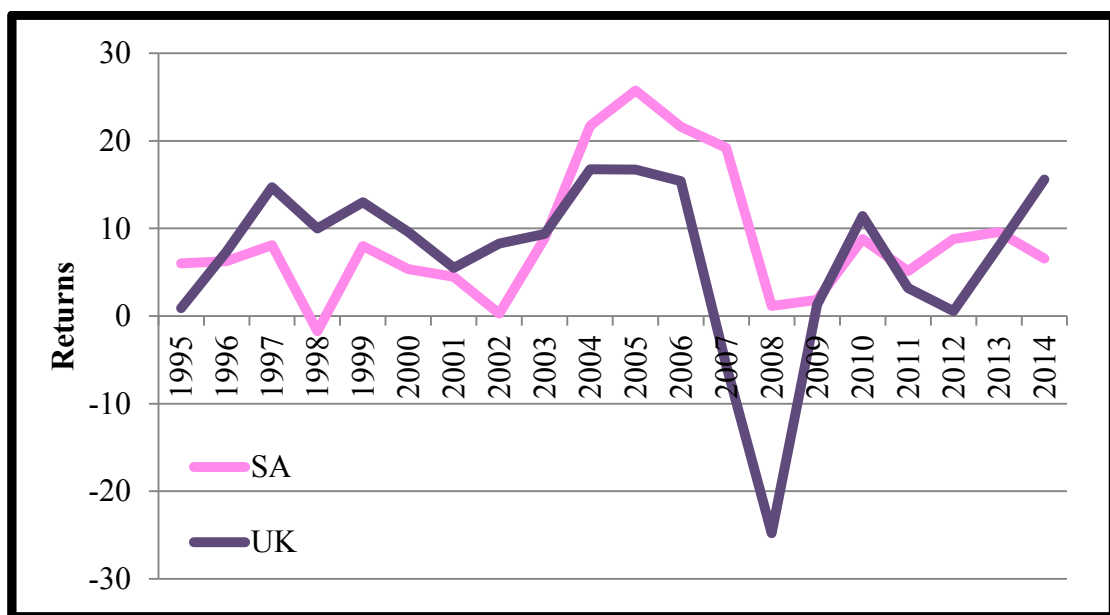

Figure 3: Comparison of SA and UK consolidated real returns (Source: IPD (2015b))

5.4 International return comparisons

Table 1 provides a numerical breakdown of the average returns, volatilities (standard deviation), and a risk/return ratio (standard deviation divided by average return) for the periods 1995-2014 and 2012-2014.

Table 1: Property market returns data (Source: IPD (2015b))

Period	1995-2014			2012-2014		
	Average Return	Volatility (Std Dev)	Risk/Return	Average Return	Volatility (Std Dev)	Risk/Return
SA	15.5%	6.5%	0.42	14.6%	1.2%	0.08
UK	9.1%	9.3%	1.01	10.6%	5.9%	0.55
Global	10.2%	6.1%	0.60	10.1%	1.3%	0.13

The average return of the SA property market for the period 1995-2014 was 15.5%, compared to the UK of 9.1% and the global average of 10.2%. The UK's market volatility is relatively high when compared to the risk/return ratio of the global market. The SA property market has the lowest volatility in the last three years. However, the UK property market has a higher risk/return ratio in comparison to the global property market (IPD, 2015a).

6. CONCLUSIONS

Both the SA and UK property markets have experienced periods of mixed property returns. This has been attributed to the performance of the global economy and market specific variables that have affected investor confidence. Since the collation of property data by IPD/MSCI in the mid 1990s the UK has been a more volatile market compared to the SA property market. The SA market has also performed better than the UK property market in terms of inflation adjusted index returns. The differing levels of maturity and transparency of the SA and UK property markets determine the institutional environment, which in turn determines the actual transactional environment for investors.

External and internal economic factors that make up the respective markets are unique to each of these countries. SA has some of the characteristics of an emerging economy, while the UK is a well-established mature transparent economy. While the performance of property markets is defined by its ability to compete against other asset classes, it is equally important to consider social, demographic, infrastructural and political parameters that affect property markets. The research has highlighted that property performance can equally be affected by these characteristics and how they dictate how the market will respond to an event. Most notably the GFC was identified to illustrate this point. The SA economy is more restricted/protected from exposure to foreign markets. The UK economy has a higher exposure to global investors and therefore needs to compete against global market trends. This minimal exposure to foreign markets benefited SA during the GFC as the economy was not as heavily impacted as the UK economy.

Despite this, economic traits and market conditions alone do not explain the function of property markets, and there are many other factors that can be considered. The physical structure of the two property markets in terms of population density, and decentralisation within the main urban regions contributes to the demand for different types of commercial properties. There is a vast difference in the number of retail properties and the catchment areas that they serve. The SA retail property sector has been consistently the best performing commercial sector, while in the UK it has been the worst performing. This can be linked to the impact of the GFC in the UK, and its resulting impact on consumer behaviour. In SA the retail sector has largely been underpinned by the opportunity to meet the needs of under-serviced townships.

The research has highlighted the need for further examination into market structures, and their characteristics. The differing market structures of developed and emerging economies have vastly different implications on the commercial real estate market, which in turn results in certain levels of volatility and return. Gaining a greater understanding of these characteristics will enable a safer environment for investment.

7. REFERENCES

- African Real Estate Society (AfRES) (2012). Available: <http://www.afresnet.net/about-site/> [Accessed February 2015].
- Barkham, R. and Frodsha, M. (2015) Simulating the cyclically adjusted returns to UK property lending. *Journal of Property Investment & Finance*, **33**(1), 66-80.
- British Property Federation (BPF) (2014) *Property Data Report 2014*. October 2014.
- Broll (2014) *The Broll Report 2013/14*. Broll/CBRE.
- Crosby, N., Gibson, V. and Murdoch, S. (2003) UK Commercial Property Lease Structures: Landlord and Tenant Mismatch. *Urban Studies*, **40**(8), 1487-1516.
- D'Arcy, E. (2009) The evolution of institutional arrangements to support the internationalisation of real estate involvements. *Journal of European Real Estate Research*, **2**(3), 280-293.
- D'Arcy, E. and Keogh, G. (2002) The market context of property development activity. In: Guy, S. and Henneberry, J. (Eds.), *Development & Developers, Perspectives on Property*, pp. 19-34. MPG Books Ltd, Bodmin, Cornwall, UK: Blackwell Publishing.
- Glass, G.G. (1976) Primary, Secondary, and Meta-Analysis of Research. *Educational Researcher*, **5**(10), 3-8.
- Investment Property Databank (IPD) (2015a) *MSCI IPD Reporting Portal* [Online]. Available: <https://padlock.ipd.com/> [Accessed April, 2015].
- Investment Property Databank (IPD) (2015b) IPD SA Annual Property Index, Results: 2014. In: MSCI.
- Jones Lang Lasalle (JLL) (2015) *Global real estate forges ahead*. Q1, 2015.
- Kiecolt, K.J. and Nathan, L.E. (1985) *Secondary Analysis of Survey Data*. SAGE Publications.
- Le, T.T.T. and Ooi, J.T.L. (2012) Financial structure of property companies and capital market development. *Journal of Property Investment & Finance*, **30**(6), 596-611.
- Lorenz, D. and Trück, S. (2008) Risk and return in European property markets: an empirical investigation. *Journal of European Real Estate Research*, **1**(3), 235-253.
- Maxted, B. and Porter, T. (2013) *Commercial Property Lending Market: Mid-Year 2013*. Department of Corporate Development, Faculty of Business and Law, De Montfort University.
- Mitchell, P. (2014) *The Size and Structure of the UK Property Market 2013: A Decade of Change*. IPF Research Programme 2011-2015, March 2014.
- Sanlam (2015) Asset Class Comparisons. Sanlam Investments, January 2015.
- StatsSA (2015). Available: <http://www.statssa.gov.za> [Accessed April, 2015].
- Trading Economics (2015). Available: <http://www.tradingeconomics.com> [Accessed April, 2015].
- Yunus, N. (2013) Dynamic interactions among property types. *Journal of Property Investment & Finance*, **31**(2), 135-159.

THE CONSTRUCTION SECTOR AND THE SILVER ECONOMY: ADDRESSING THE CHALLENGES AND OPPORTUNITIES

L. Ruddock¹ and S. Ruddock²

¹ School of the Built Environment, University of Salford, Salford M5 3NE, UK

² School of Built Environment and Architecture, London South Bank University, London, SE1 0AA, UK

Email: L.Ruddock@salford.ac.uk

Abstract: In most developed countries, population ageing is beginning to have an increasing impact on society and the economy and is creating many challenges for the construction and property sectors. Ageing populations need high quality built environments that suit their needs along the whole life course. A building stock and infrastructure that support independent living and enhance the quality of life of the ageing population, and that make use of the full range of available ICT solutions are important in order to turn ageing into an opportunity for economic growth and well-being. This change is throwing up new challenges for the construction industry and housing providers, not only in terms of a demand for new specialist housing but also a potentially growing market for spending on home adaptations, maintenance and improvements. All these new development and refurbishment aspects need to provide an age-friendly environment, while remaining economically and financially viable. This paper reports on the development of an agenda for the European Union to deal with the innovation challenges and opportunities facing the construction industry. Alternative approaches to a range of actions are analysed in the context of their ability to enhance both the well-being of the ageing society and, at the same time, provide an opportunity for economic growth. The paper explains the approaches followed in the development of a *European Framework for Age-Friendly Housing* and considers the required focus for research in this domain.

Keywords: Ageing Population, Construction Sector, Economy, Housing

1. INTRODUCTION

1.1 The ageing population

In many parts of the globe, the age profile of the population is changing rapidly and this is the case throughout most of the current European Union member countries (EU-28). By 2050, the world is projected to have 1.3 billion older people, accounting for 14% of the total global population and it is predicted, that by 2022, people aged 65 and older will outnumber children for the first time in history (United Nations, 2013). The impact of demographic ageing within the European Union will be of major significance in the coming decades as higher life expectancy is transforming the shape of the EU-28's age pyramid and the most important change will be the marked transition towards a much older population structure.

As a result, the proportion of people of working age in the EU-28 is shrinking while the relative number of those retired is expanding. Figure 1 shows this changing demographic profile. The share of older persons in the total population will increase significantly in the coming decades, as a greater proportion of the post-war baby-boom generation reaches retirement age. This will lead, in turn, to an increased burden on those of working age to provide for the social expenditure required by the ageing population for a range of related services. Population ageing has (and will continue to have) an increasing impact on society and the economy and is particularly creating myriad challenges for the construction and property sectors.

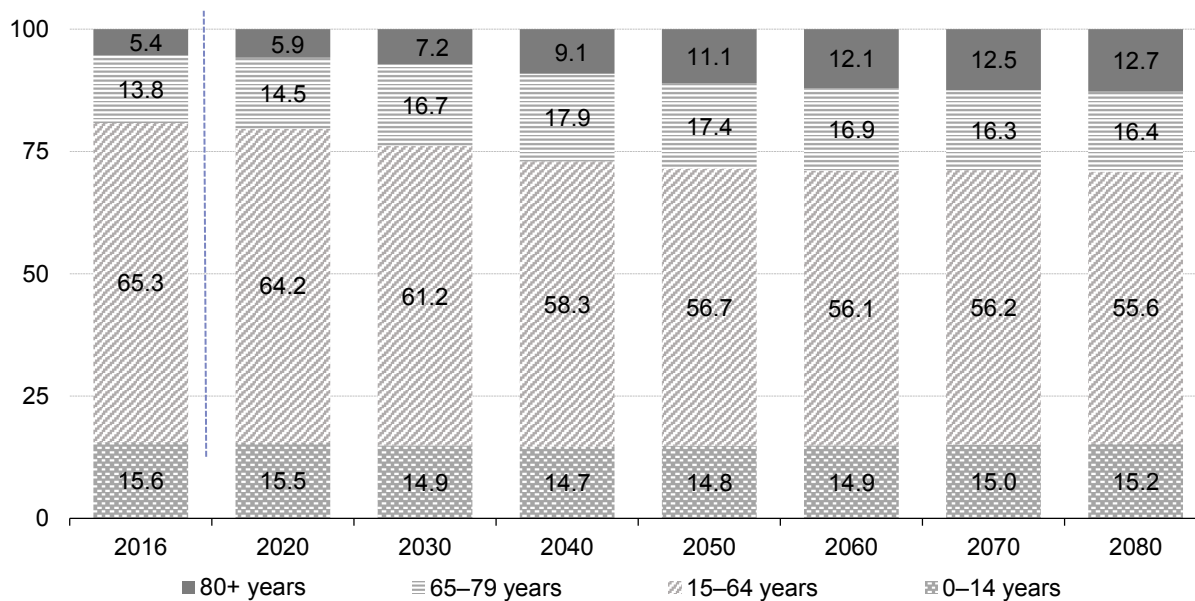

Figure 1: EU 28 Population structure by major age groups 2016-2080 (% of total population)

Source: Eurostat (2017)

Of major concern to these sectors are the economic and financial impacts of an ageing population. These include the need to determine optimal pathways and financial / economic models for improving and adapting the built environment, to meet the needs of older adults in the community. This requirement embraces all stakeholders, including those associated with investment, supply, demand and ownership aspects.

1.2 The extent of the ageing homes issue in Europe

At present, the European housing stock and built environment are not ready to support independence for the ageing, integrate digital innovations, and enable older Europeans to lead healthy, meaningful and active lives, at home and in the neighbourhood. With renovation and replacement rates of less than 3% of the housing stock across the EU (ECTP, 2014) this is not likely to change quickly enough to keep pace with changing demographics and the related demand for age-friendly homes. It is an innovation challenge. Unless an approach is defined to mainstream available solutions, Europe's ageing populations will not find adequate housing options and environments to meet their needs. The added value of age-friendliness in renovation or new building projects is not always obvious to public or private homeowners and clear guidelines for the execution and financing of such projects scarcely exist.

Across Europe, the additional demand for age-friendly homes is likely to be ten million by 2020 (ECTP, 2015) and the current level of housebuilding will not be able to provide for this demand. The age-friendly housing market has high potential for the construction sector. Targeted actions and investments can provide significant returns, both in terms of supporting European citizens to age well, and supporting new business and procurement models for the European housing, construction and ICT sectors. The challenge includes both the retrofitting of existing buildings as well as defining minimum standards and guidelines for new buildings and infrastructures. In terms of economic potential, the construction sector alone already

underlines the scope of the opportunity. It is the biggest industrial employer in Europe, representing 8.5% of EU gdp, 6.4% of Europe’s total employment and nearly 31% of industrial employment with 42.3 million workers in Europe dependent directly or indirectly on the construction sector (FIEC, 2015). Targeted *silver economy* actions for the sector have the potential to create a massive impact in terms of economic growth and new jobs. Depending on the definition of an age-friendly home, the investment task is estimated to range from €105bn to €850bn. Even with a conservative estimate of an investment of €200bn for the ICT and construction sectors, this will create knock-on effects of €200-374bn in additional market activity and 1.7 million new jobs across Europe (ECTP, 2015). While diversity of incomes, capital and spending power among older adults is significant, as a group, the current generation of baby-boom retirees can be considered to be better off than past (and future) generations and other age groups. At present, an important share of older persons’ spending power is dedicated to housing maintenance work, with persons over the age of sixty accounting for 33% of all expenditure, and the purchase of household equipment including ICT, where the over-sixties account for 27% of spending in the EU. According to a Bank of America - Merrill Lynch (2014) report, the global silver market is estimated to be US\$ 15trillion by 2020. Moreover, home ownership among this group is high in most European countries, with considerable capital assets tied up in private property. This is exemplified by the housing tenure situation in England where, according to the English Housing Survey (DCLG, 2015a), in 2014, almost 90% of owners of pension age owned their property outright but there are marked differences between tenure groups by age. Most house buyers take out a mortgage and do not own their home outright until later in life but, as Figure 2 illustrates, there are now more households owning their property outright than there are still paying a mortgage and, most significantly, 85% of outright owners were aged 55 or more.

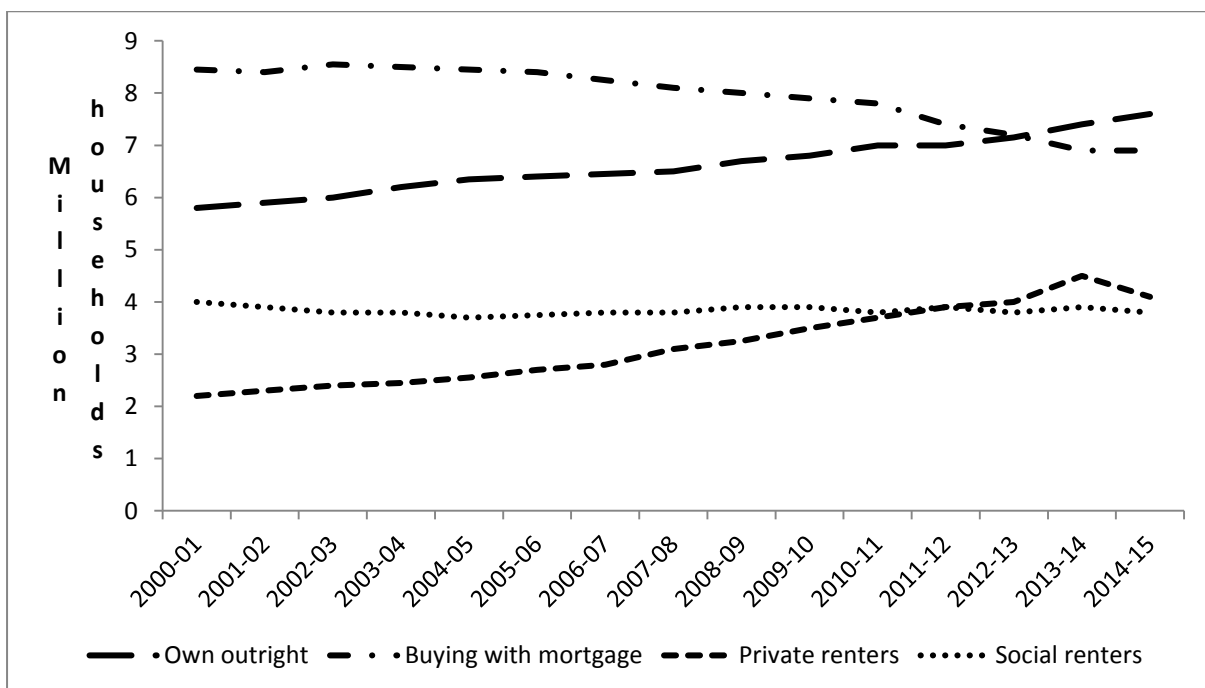

Figure 2: Trends in the tenure of housing in England
 (Source: English Housing Survey (DCLG, 2015))

All this indicates that older adults as a group of consumers have the potential to provide a significant market opportunity to drive change in the age-friendly housing domain. So far,

however, these markets have not yet manifested, which constitutes an important barrier to innovation and scale (ECTP, 2015).

2. DETERMINING AN AGENDA FOR AGE-FRIENDLY HOUSING RESEARCH IN EUROPE

The European Commission launched the pilot *European Innovation Partnership on Active and Healthy Ageing* (EIP-AHA) in 2010. The partnership brings together public and private stakeholders across sectors (construction, information technology, health and social care) to accelerate the uptake of innovation in order to increase the average healthy life-years of European citizens with a particular focus on older people. The EIP-AHA, with its strategic implementation plan, delivered its vision of addressing this challenge and, in response, the Commission requested invitations for commitment and launched an Action Group (D4) on *Innovation for Age-friendly Buildings, Cities and Environments*. Since 2012, the D4 Action Group has brought together regional and local authorities from across the European Union, European ngos, technology and construction providers and research centres.

In order to contribute to the D4 Action Group, the European Construction Technology Platform (ECTP) set up a commission on *Active Ageing and Design* (previously known as *Active Ageing in the Built Environment*) to identify the most important research, innovation and valorisation actions, aiming to deliver a strategic research agenda by the end of 2017. As part of this commission, a task group on economic and financial aspects was set up and, in 2015, the ECTP published a position paper on *European RDI policies for the Construction Sector in the Silver Economy* outlining the potential impact for the construction sector and identifying the research and innovation challenges. The focus of the work was concerned with how to improve the quality of houses and neighbourhoods for older citizens at scale with a premise that knowledge and solutions exist, but what is lacking is the scale and innovation.

For D4's latest Action Plan (for 2016-18), the ECTP has been a major contributor to the report *Towards a European Reference Framework for Age-Friendly Housing* (ERF-AFH). In order to develop the framework, a Europe-wide consultation process termed *The Neighbourhoods of the Future Roadshow* was undertaken. Ten interconnected open invitation workshops with representatives from a broad range of stakeholder groups were undertaken. The workshops constituted consultations with engaged stakeholders in order to have a dialogue about the opportunities and challenges of the ERF-AFH. DG Connect (the relevant Directorate-General of the European Commission) plans to elaborate the ERF-AFH together with relevant stakeholder groups and they will do this together with already existing platforms, such as ECTP, to lead work on specific themes/sectors. This paper considers the issues and challenges in processing the results into a strategic research agenda that will be presented to DG Connect before the end of 2017.

To this end, the ECTP Committee has concerned itself with the determination of the processes for the strategic research agenda and focused on three themes as illustrated in Figure 3. While economic and financial considerations are prevalent across the three themes, it is the scaling-up and implementation aspects that are most relevant to the context of this paper. The development of appropriate business models and the identification and measurement of the direct and wider benefits from the provision of age-friendly homes and an age-friendly built environment provide a basic underpinning to economic and financial viability and sustainability.

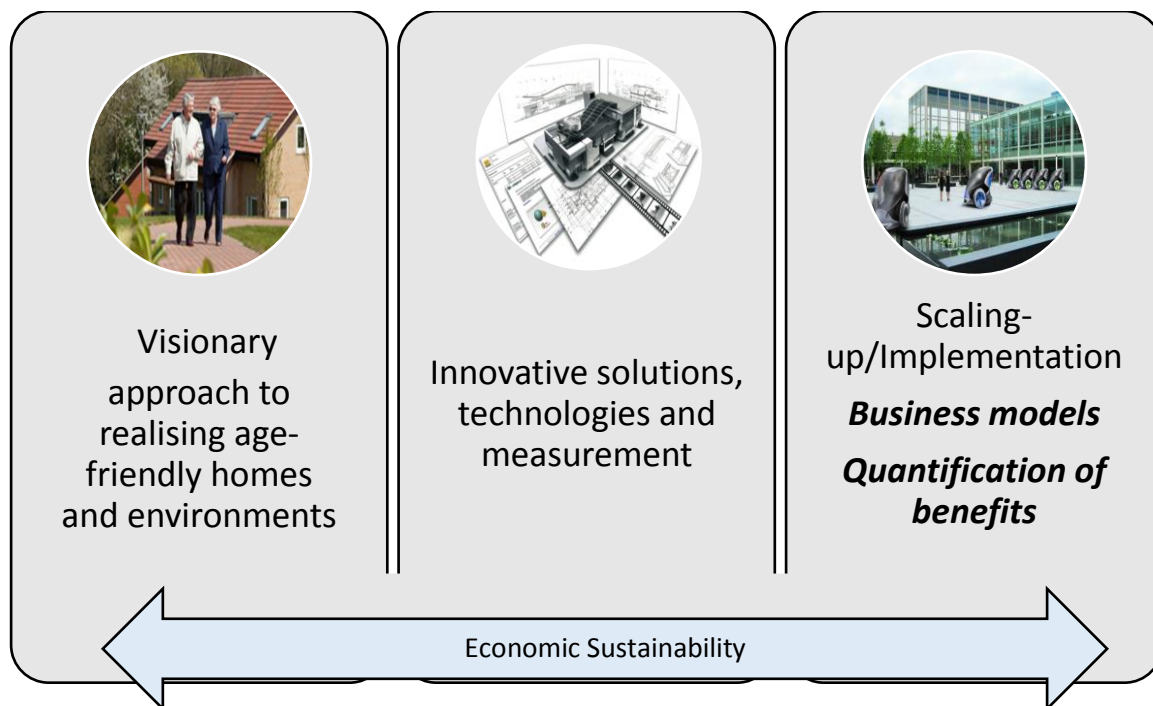

Figure 3: Research approach: Themes developed by the ECTP Active Ageing and Design Committee

2.1 The consultation workshops: The financial issues

During the consultation workshops of *The Neighbourhoods of the Future Roadshow*, the key financial challenges that were most prominently expressed by stakeholder participants concerned the lack of consumer buy-in and public investment. This represents a twofold challenge – combining the unlocking of consumer spending with the redirection of public investments into the age-friendly housing market, where necessary. Participant stakeholders felt that there is insufficient transparency as to what is available and possible. While solutions and knowledge exist, there is a lack of availability in the form of services, business models or simply widespread knowledge.

An example of the problems in activating the potential from mutual benefits for different stakeholders from the construction and ICT sectors for potentially shared new business opportunities was demonstrated at the workshops (Peine and Arentshorst, 2016). During the Dutch workshops in Arnhem and Utrecht, the issue of a reverse waiting game between ICT and installation companies and construction companies was raised. The Arnhem workshop brought together a group of around 25 smaller ICT and installation companies, to discuss ideas about age-friendly homes and innovation actions required to bring the ICT and construction sectors together. Participants flagged the need to provide flexible solutions for diverse and changing needs as a key challenge but this was framed as a challenge for the ICT sectors. The construction sector, on the other hand, was perceived to be too conservative, with over-long timeframes for the provision of flexible solutions. The view being that it is the job of the ICT sector to make bricks and mortar provided by construction “dynamic” and “smarter”, such as through the provision of virtual walls. During the Utrecht workshop, a slightly different twist on the same story emerged. Here, participants from construction downplayed the challenge for the ICT sector, with comments such as ‘it’s what they do anyway and isn’t exciting’. The true opportunity for change and new business, in this account, exists for the construction sector –

i.e. in the provision of flexible built environments, such as modular houses, flexible infrastructures and overall a good mix of housing options in the neighbourhood. Effectively, both types of stakeholder framed the opportunity in terms of their own businesses but bringing these stakeholders together during the roadshow underlined that the true opportunity is a shared one, with both sectors having something to offer and something to gain. Bringing out such mutual opportunities and taking consideration of the potentially shared new business can unlock potential regarding the value of looking beyond one sector's vested interest, and exploring collaborative approaches to tackle the opportunities together. An underlying problem to this 'reverse waiting game' is the different time cycles of the construction and ICT sectors. For the built environment, it is crucial to get things right as changes after the fact are very difficult to realise, even for building modifications, whereas for the ICT sector this is less the case. Collaboration (and investment) strategies need to take these different temporalities of the sectors into account.

Although some participants during the Roadshow pointed to governments as having the main responsibility for financing the domain, there also seemed wide agreement that there is actually enough money in the system already. The ERF-AFH could make a significant contribution to providing solutions to financing issues to unlock or re-direct investments by collecting good practices of financial instruments and making them specific for the age-friendly housing domain. At a broad level, some participants expressed the view that coordinated actions across sectoral boundaries would lead to the availability of financial means and investment. The underlying rationale being that, with the collaboration of relevant stakeholders, the added-value of investing into the age-friendly home domain would become clear, including the potential for economic impact and return on investment. While it remains to be seen whether this is realistic, participants also flagged a number of more specific instruments for their potential to stimulate both private and public investments. These included: low-interest loan schemes (such as the Altersgerecht Umbauen scheme of the German KfW bank or the Blijverslening of the Dutch Stimuleringsfonds Volkshuisvesting) for home owners to invest in age-friendly home modifications; reverse mortgages (by which home owners can take a loan on their property, but defer payment until they die or move out); tax breaks for certain age-friendly home modifications; social business cases to demonstrate return on investment broadly defined, and social impact bonds (a bond whereby the public sector guarantees a return to bond holders based on certain metrics for social outcomes). These instruments are aimed at both capital tied up in the surplus value of private houses, and at business cases for public authorities, to demonstrate how public investments into housing can avoid health or care costs. While the Roadshow did not provide an opportunity to evaluate these instruments in sufficient detail, agreement seemed to exist that a good understanding of investment mechanisms, and their working in the age-friendly housing domain is an essential next step that needs coordination at the European level. The feasibility and success of these schemes depends, in large parts, on a clear definition of what counts as an investment into an age-friendly home modification, and how the impact of such modifications can be measured. The examples above also show that 'merely' an organisational element is not sufficient in realizing more age-friendly homes and neighbourhoods. With the range of sectors involved in the age-friendly housing domain, smart blends of available financing mechanisms, both public and private, are necessary. The different mechanisms mentioned should be part of a larger ongoing movement that needs to communicate clearly the value propositions for different stakeholders, including end-users, to engage in the age-friendly housing domain. Proper cost-benefit analyses, societal business cases and clear measures, key performance indicators and evidence for return on investment should be part of that mix. Furthermore, participants also flagged that smart public-private

partnerships need to be defined that combine different sources of investments, and implement coordinated actions at scale.

2.2 New cross-sectoral business models needed

The ageing society is putting increasing pressure on existing housing, health and care systems and an integral aspect of the challenge of providing age-friendly homes and environments is the need for an integrated approach between the construction, ICT and healthcare sectors as the built environment, enhanced by new opportunities from digital innovation, matters crucially in defining favourable conditions for healthy ageing. The EC is investing €20mn in a large-scale pilot that focuses on “smart living” as part of digitising European industry and this *Alliance of Internet of Things Innovation* (AIOTI) has a dedicated working group on ‘smart living environments for ageing well’. The smart Silver Economy project has identified age-friendly built environments as one of 10 key opportunities to grow the Silver Economy and this highlights the fact that the built environment is an important arena for innovation in this project. Europe’s ageing population needs high quality built environments that suit their needs across the whole life course. Hence, a building stock and infrastructure that supports independent living and enhances quality of life of the ageing population, making use of available ICT solutions such as the internet of things, is important to mitigate health and care costs, and turn ageing into an opportunity for economic growth.

When the health domain is added to the collaborative mix, workshop participants again pointed out actions of other sectors as a requirement for the own sector to improve. Typical examples are construction companies waiting for developers to articulate demands; ICT companies waiting for a standard or platform to emerge; product and service providers to wait for the health sector to clarify the evidence and or for insurance companies to update reimbursement rules. The ERF-AFH needs to stimulate sectors to break out of these waiting games – by defining new gaming tactics and strategies. Lessons learned from local pioneer initiatives encountered are essential in this regard. However, these need to be supported by system level changes, such as incentives, new procurement and financing models and regulatory changes. In other words, the ERF-AFH should connect bottom-up approaches to ‘work the system’ with the strategic level of changing the system where necessary.

Cross-sectoral collaboration remains challenging at the very fundamental level of defining actions across different sectors. Social care and health stakeholders are not used to collaborating with construction and vice-versa construction companies are not used to including health or ageing issues in building information systems. Likewise, for architects and urban planners, it is still unusual to focus on health and care provision in the community and ICT companies tend to perceive the construction sector to be conservative, and thus not able to provide the flexibility and pace needed to create sufficiently flexible and stimulating smarter environments. The ERF-AFH can provide essential guidance by making clear the respective needs of and value propositions for the stakeholders involved in these new consultations.

3. RECOMMENDATIONS FOR RESEARCH FOCUS

In order to provide the solutions to the financial and economic challenges, the focus has to be based on the identification of available and innovative financing mechanisms to analyse how these can be made specific for replication and scale. Unless there are measures initiated to

influence the market, the required increase in the stock of age-appropriate housing will not happen. The issues involved in bringing this about lead to a number of research questions that need to be considered in order to initiate activity on the part of all the various stakeholders concerned with housing provision.

- *What are the effective market mechanisms that should be influenced by government?*

Governments cannot assume that housing markets will self-regulate to deal with the issue of ageing persons' housing needs (Ruddock and Ruddock, 2016). As the population is ageing, the housing market is having trouble keeping up. In some member states, there are a small number of construction companies specialising in retirement housing developments, but there has been a general reluctance amongst private commercial developers to become involved with such developments. From the developer's viewpoint, retirement properties can take longer to sell and do not generate volume sales. The use of both of regulatory measures, such as the exemption from land-use planning restrictions that apply to mainstream housing for new housing for older people, and fiscal measures such as the removal of taxes/duties involved in seniors downsizing to reduce the upfront cost required for a move, could also stimulate the market along the housing chain. In most EU countries, local and regional authorities, with an ability to control public land, should have a housing strategy for older people with targets for retirement housing in their plan. Agreements regarding planning obligations with developers could be used by planning authorities to ensure the provision of an agreed amount of age-friendly housing to incentivise a greater supply.

- *What should be the standards set for age-friendly/lifetime homes?*

All new homes and renovation projects should be built to age-friendly/lifetime homes standards. Standards should include the opportunity for full use of technological innovation and, in the near future, standards/guidelines will have to be developed with scalable market of new products. For example, in the UK, it has been recognised by government that future reviews of building standards consider the longer term social benefits of accessible design as well as the immediate upfront costs to developers (DCLG, 2015b).

- *How can the release of housing equity can be more efficiently accomplished?*

Though some schemes exist through the use of financial vehicles to permit equity release, they are little used. Past research has shown that householders have been reluctant to use such schemes. Cocco and Lopes (2015) studied the role of housing wealth for the financing of retirement consumption, especially concerned with the design of financial products that allow households to tap into their home equity. They found that there appears a reluctance to use such equity to purchase a low value property or to discontinue home ownership due to a precautionary saving motive (due to uncertainty of life span and medical reasons) (De Nardi and Jones, 2010) or as a hedge against future house price fluctuations (Sinai and Souleles, 2005). It is reasonable to expect those who have benefited in this way to support their own longer lives. As in other EU states, there is in the UK considerable equity in older people's housing- an estimated £250 billion (Smith Institute, 2012) and the this is increasingly seen by policy makers as a potential solution to meeting the cost of later life care (Dilnot Commission, 2011).

- *How can private house builders be enticed to develop new partnerships involving all relevant stakeholders, to explore and agree upon new modes of providing large-scale renovation projects?*

The construction sector must aim to develop sustainable new business models and it needs to work with both the ICT and health sectors in this area of activity. In 2015, public expenditure

on health and long-term care accounted for 8.7% of gdp in the EU and could reach up to 12.6% of gdp in 2060 (European Commission, 2015; European Commission, 2016). Alleviation of the healthcare budget due to the development of an age-friendly environment would have enormous financial benefits. Developments in assistive technology in the home have considerable potential to improve support at home for older people and reduce care and health costs. It can range from the very basic to more sophisticated telecare and telemedicine systems at the smart homes end of the spectrum with the case for smart homes reliant on economic scenarios demonstrating benefits through savings in institutional care (see Le et al, 2012). Co-creative ICT-based design and development approaches will allow key supply sectors in the construction industry to work more effectively with institutional and private clients to integrate smart home and IOT-technologies.

- *How can householders themselves be persuaded to invest in age-friendly technology?*

Older people need to be convinced that they should be looking at retirement housing as a lifestyle choice rather than being forced into such housing because of their future care needs. They need to be encouraged to invest in age-friendly technology based on sound evidence of the benefits. Cost-benefit analyses (such as Cobbold, 1997) assessed the major benefits of building to lifetime home standards in terms of the cost savings from delaying the need for older people to move into residential care, the cost of which is substantially higher than home-based care. Nevertheless, soaring levels of residential care costs over the last decade have increased still further the potential savings from ensuring that newly constructed homes comply with lifetime home design standards. Investment in aids and adaptations has considerable economic benefits with adaptations a key component in reducing hospital admissions, allowing the delivery of care and support in the home and promoting independence.

- *What instruments could financial institutions develop to promote investment?*

Apart from the aforementioned equity release and reverse mortgage instruments, the implementation of consistent design standards for age-friendly homes could be taken up by financial institutions to develop loan and financing schemes for older home-owners to be able to invest in age-friendly homes (see the German and Dutch examples in Section 2.1). Investment is needed to finance smart homes and this could be based on the setting up of innovation funds, encouraging social investment from pension funds or the mobilisation of alternative sources of finance, such as Real Estate Investment Trusts (REITs) specifically for seniors' residential property.

All the relevant, aforementioned stakeholders in the age-friendly housing sector need to work together to ensure that age-friendly home environments can be provided in a cost-effective way and only through a multi-stakeholder exploration of innovative business models and partnerships can the high quality built environments that fit people's needs across their life course be developed.

In conclusion, the D4 innovation action plan will focus on the challenges in the research and innovation field, with a need to understand and define the social and economic business case for innovation. This includes getting to grips with the dynamics of stakeholder motivations, interests and interactions grasping what is necessary to marshal investments in the physical environment and helping to create appropriate framework conditions to facilitate scaling-up and business update of solutions.

4. REFERENCES

- Bank of America Merrill Lynch (2014), *The Silver Dollar – Longevity Revolution Primer*, <https://ec.europa.eu/research/innovation-union/pdf/active-healthy-ageing/merrill.pdf> Accessed: 30 May 2017.
- Cobbold, C. (1997), *Cost Benefit Analysis of Lifetime Homes*, Joseph Rowntree Foundation, York.
- Cocco, J.F. and Lopes, P. (2015), *Reverse Mortgage Design*, Working Paper, London Business School.
- DCLG (2015a), *English Housing Survey 2013 to 2014: Household Report*, Department for Communities and Local Government, London.
- DCLG (2015b), *The Housing Standards Review*, available at: <https://www.gov.uk/government/consultations/housing-standards-review-technical-consultation> Accessed: 8 May 2017.
- De Nardi, E.F. and Jones, J.B. (2010), Why Do the Elderly Save? *Journal of Political Economy*, Vol.118 (1), pp.39-75.
- Dilnot Commission (2011), *Funding of Care and Support*, Department of Health, London.
- ECTP (2014), *Active Ageing in the Built Environment: Strategic Research Agenda Report*, European Construction Technology Platform, Brussels.
- ECTP (2015), *European RDI policies for the construction sector in the silver economy*: <http://bit.ly/1pcat1f8> Accessed: 30 May 2017.
- European Commission (2015), *The 2015 Ageing Report: Economic and budgetary projections for the 28 EU Member States (2013-2060)*, European Economy3|2015, Publications Office of the European Union, Luxembourg.
- European Commission (2016) *Joint Report on Health Care and Long-Term Care Systems & Fiscal Sustainability*, https://ec.europa.eu/info/publications/economy-finance/joint-report-health-care-and-long-term-care-systems-fiscal-sustainability-0_en Accessed: 26 May 2017.
- Eurostat (2017), *European Statistics Explained*, http://ec.europa.eu/eurostat/statistics-explained/index.php/Population_structure_and_ageing Accessed: 28 May 2017.
- FIEC (2015), *Key figures of Activity 2015*, European Construction Industry Federation, Brussels.
- Le, Q., Nguyen, H.B. and Barnett, T. (2012), Smart Homes for Older People: Positive Aging in a Digital World, *Future Internet* 4, pp. 607-617.
- Peine, A. and Arentshorst, M. (2016) *Support for the development of smart and age-friendly housing in the Silver Economy*, European Commission, Brussels.
- Roys, M. (2012), *Assessing the health benefits of Lifetime Homes*, DCLG, London.
- Ruddock, L. and Ruddock, S. (2016), The Financial and Economic Challenges of Housing Provision for an Ageing Society, *Journal of Financial Management of Property and Construction*, Vol 21 (2), pp. 85-98.
- Sinai, T. and Souleles, N. (2005), Owner-occupied Housing as a Hedge against Rent Risk, *Quarterly Journal of Economics*, Vol. 120 (2), pp. 763-789.
- Smith Institute (2012), *Making the Most of Equity Release: Perspectives from Key Players*, The Smith Institute, London.
- United Nations (2013), *World Population Ageing 2013*, Department of Economic and Social Affairs, United Nations, New York.

DEEP RENOVATIONS IN DIFFERENT BUSINESS ENVIRONMENTS

T. Vainio¹ and E. Nippala²

¹ *Smart energy and transport solution, VTT Technical Research Centre of Finland,
Tekniikankatu 1, 33720 Tampere, Finland*

² *Construction and environmental engineering, Tampere University of Applied Sciences,
Kuntokatu 3, 33520 Tampere, Finland*

Email: terttu.vainio@vtt.fi

Abstract: EU Member States are encouraged to promote energy upgrading to a higher level than EPBD by Energy Efficiency Directive, EED Article 4. The increased efficiency measures, such as a 60 per cent reduction in energy consumption, are now required. Obviously, from an economic point of view the challenge varies from country to country. The objective of this study is to compare the challenges of deep renovation targets in different economic environments. A deep renovation concept for a residential building is the same in every assessed country and is formulated on the basis of joint research projects. Characteristics of the different countries taken into account are: degree days, energy price level and construction cost level. The values of variables are determined by EU Statistics. The comparison method is payback period. It is easiest to achieve targets in several Eastern European countries, where buildings are wasting energy, energy is relatively expensive and construction costs are low. It is significantly more difficult to achieve the target in the Northern Europe where cold winters have through the decades have forced investments in energy-efficiency, energy is relatively cheap and construction costs are high. Even when technically Deep Renovations look feasible; they may be still too expensive.

Keywords: Deep Renovation, Energy, Payback Period.

1. INTRODUCTION

Energy efficiency has become a key priority of the Europe 2020 strategy for smart, sustainable and inclusive growth, and resource efficiency (EU, 2010c). Through efficiency, security of the energy supply will be improved, emissions will be reduced and energy reserves wasted due to inefficiency will be recovered.

The EU's updated strategy, which will extend up to 2030, has the aim of reducing greenhouse gases by 40 percent compared to the 1990 level. In addition, a binding target has been set for the use of renewable energy (EU, 2014). The Paris climate agreement, signed in the autumn of 2015, will further tighten requirements set for the energy efficiency of buildings and the adoption of renewable energy (UN, 2015).

The first step in implementing the strategy with regard to the existing building stock was the requirement to improve energy efficiency during renovations (EU, 2010b). In addition, the public sector has been tasked with setting an example by entering into energy efficiency agreements, improving the energy efficiency of public buildings, making energy efficiency a criterion for awarding public contracts, and obliging energy companies to help consumers cut energy consumption.

The energy efficiency of buildings is regulated by a specific 'Energy Performance of Building Directive (EPBD)'. However, the generally applicable Energy Efficiency Directive (EED) requires measures that go further. It requires member States to incentivise investment in the

deep renovation of buildings (EU, 2012). Construction is also subject to the Renewable Energy Directive (EU, 2009) on the use of renewable energy and the Eco Design Directive on the energy efficiency of products (EU, 2010a). Energy performance certificates (EPC) are a result of regulations such as these.

2. DEFINITION FOR DEEP RENOVATION

Horizon 2020 Energy Efficiency Call 2015 defines that a 'deep renovation' in accordance within the Energy Efficiency Directive (EU, 2012) is a cost-effective renovation which leads to a refurbishment that reduces both the delivered and final energy consumption of a building by a significant percentage compared with the pre-renovation levels, leading to a very high energy performance. It also states that such deep renovations could also be carried out in stages. The European Commission Staff Working Document (EU, 2013) indicates that the significant efficiency improvements resulting from deep renovation are typically of more than 60% energy savings. According to Economidou et al. (2011), a 'deep renovation' typically adopts a holistic approach, viewing the renovation as a package of measures working together, and resulting in final energy savings of 60-90%.

The recast of the directive of energy performance of buildings (EU, 2010b) does not mention 'deep renovation' at all. Instead, it states that Member States should be able to choose to define a 'major renovation' either in terms of a percentage of the surface of the building envelope or in terms of the value of the building. If the value is chosen, the value of the land upon which the building is situated should be excluded. In article 2, the recast gives two alternative definitions (Sajn et al. 2016; Artola et al. 2016) of 'major renovation' for Member States to choose. 'Major renovation' is done if either a) the total cost of the renovation relating to the building envelope or the technical building systems is higher than 25% of the value of the building, excluding the value of the land upon which the building is situated, or (b) more than 25% of the surface of the building envelope undergoes renovation.

When analysing renovation tracks for the renovation of the EU building stock for the period to 2050, Boermans et al. (2012) do not define 'deep renovation' properly. The 'deep renovation and high use of renewable energy' is described to include a renovation rate of 2.3%, high level of energy efficiency improvement (~80% reduction in energy use for space heating), high focus on energy efficiency of the building envelope, and advanced systems (high use of renewable energy and heat recovery ventilation).

Fabbri et al. (2016) highlight that there currently isn't a common definition of 'deep renovation'. But they provide an overview of the main definitions of deep renovation used in the EU. According to Fabbri et al., deep renovation is a process enabling the full potential of a building to reduce its theoretical energy-demand by careful planning of the renovation to avoid the installation of lock-in measures. Deep renovation can be approached with the following methods: a) Percentage of energy-savings realised; b) Maximum energy performance; c) A selection of energy-saving measures to be executed.

After a series of webinars and a questionnaire, Shnapp et al. (2013) define that 'Deep Renovation' or 'Deep Energy Renovation' in the EU captures the full economic energy efficiency potential of improvement works, with a main focus on the building shell, of existing buildings and leads to a very high-energy performance. The renovated buildings energy reductions are 75% or more compared to the status of the existing building/s before the

renovation. The primary energy consumption after renovation, which includes, among other things, energy used for heating, cooling, ventilation, hot water and lighting after the deep renovation of an existing building is less than 60 kWh/m²/yr.

Instead of a definition for deep renovation a long-term efficiency objective is used (Fabbri et al., 2016): existing buildings must achieve the E60 level by 2050 corresponding to a primary energy demand of 100 kWh/m² for gross surface, combined with a series of mandatory requirements (measures and installations). New buildings today must achieve an efficiency level of E60, while nZEB level is defined as E30.

3. GOAL

The objective of this study is to compare the challenges of deep renovation in different economic environments. The comparison is made from an economic point of view and only concerns residential buildings. The ability and living standard are excluded even they are either important boosting or slowing down factors.

4. METHODOLOGY AND VARIABLES

4.1 Methodology

The method used in country by country comparison is payback period. This means the time that a project requires to cover the investment. In a deep renovation project the investment is a set of measures, which cut energy use by 60 %. The saving target is the minimum mentioned in the definition paragraph. Investment is covered by energy savings. The payback period of a project is expressed in years and is computed using the following, applied formula:

$$\text{Payback period} = \frac{\text{Investment required for a project}}{\text{Net annual cash flow}} \sim \frac{\text{Deep renovation}}{\text{Energy saving}}$$

According to this method, the project that promises a quick recovery of initial investment is considered desirable. If the payback period of a project computed by the above formula is shorter than or equal to the management's maximum desired payback period, the project is accepted, otherwise it is rejected. For example, if a company wants to recoup the cost of an investment within 5 years of purchase, the maximum desired payback period of the company would be 5 years.

Advantages of payback period are:

1. Payback period is very simple to calculate.
2. It can be a measure of risk inherent in a project. Since cash flows that occur later in a project's life are considered more uncertain, payback period provides an indication of how certain the project cash inflows are.
3. For companies facing liquidity problems, it provides a good ranking of projects that would return money early. In this case to save energy after the payback period is good for housing companies to get lower energy costs.

Disadvantages of payback period are:

1. Payback period does not take into accounts the time value of money, which is a serious drawback since it can lead to wrong decisions. A variation of payback method that attempts to remove this drawback is called discounted payback period method.
2. It does not take into account, the cash flows that occur after the payback period.

4.2 Variables by country

Variables are country specific and adopted either from Eurostat or other EU data sources to ensure the consistency and comparability of the input data (table 1). The review looks the price level 2015-2016.

Heating degree days: Consumption of energy depends strongly on weather conditions. If the temperature decreases below a certain value, "heating threshold", more energy is consumed due to the increased need for space heating (Eurostat, Heating degree-days).

Specific energy consumption of residential buildings per m² at normal climate, based on formula: $X=A/(1-(B*0,9)*(1-C/D))/E$ where A is energy consumption of a residential building; B is the share of space heating; C is degree-days; D is normal degree-days (1980-2004); E is the total floor area of permanently occupied-dwelling (EU, Building Stock Observatory).

Residential construction price level index: The index expresses the residential construction price levels to EU28. If the price level index of a country is higher than 100, the country concerned is relatively expensive compared to the one to which it is compared (for example in the EU), while if the price level index is lower than 100, then the country is relatively cheap compared to the other country (Eurostat, Comparative price levels for investments, year 2015)

Value added tax rate: The value added tax (VAT), is a general, broadly based consumption tax assessed on the value added to goods and services. VAT is charged as a percentage of prices, meaning that the actual tax burden is visible at each stage in the production and distribution chain (European Union VAT rates, year 2014).

Electricity price: The price of energy depends on a range of different supply and demand conditions, including the geopolitical situation, import diversification, network costs, environmental protection costs, severe weather conditions, or levels of excise and taxation. Prices presented in the table include taxes, levies and VAT for household consumers (Eurostat, Energy price statistics, year 2016).

Deep renovation: The deep renovation concept is common to all countries and it is formed on the basis of EU GUGLE project (Morishita, 2016). The concept includes renovation of facades and windows, and installation of heat recovery and photo voltage panels. The total cost of reparation concept (I) is 190 euro per m² (price level EU27 excluding VAT and subsidies). The total cost is tailored to each country by taking into account the construction price level and VAT rate.

Table 1: Variables by country

	Heating degree days (D)	Residential buildings, specific energy consumption kWh/m²; a (X)	Residential construction price level index EU27=100 (Y)	Value added tax rate % (V)	Electricity price euro / kWh (Z)
Belgium	2696	263	99	21	0.25
Bulgaria	2403	121	35	20	0.10
Czech Republic	3327	234	59	15	0.14
Denmark	3235	169	150	25	0.31
Germany	3063	200	136	19	0.30
Estonia	4302	290	67	20	0.12
Ireland	2841	166	91	14	0.23
Greece	1449	121	62	24	0.18
Spain	1686	103	69	10	0.22
France	2340	190	116	20	0.17
Croatia	2316	250	44	25	0.13
Italy	1829	175	74	10	0.24
Cyprus	600	69	64	5	0.15
Latvia	4161	292	61	21	0.16
Lithuania	3931	204	59	21	0.12
Luxembourg	2967	205	106	17	0.17
Hungary	2594	150	46	27	0.11
Malta	499	47	64	18	0.13
Netherlands	2727	152	114	21	0.16
Austria	3301	198	116	20	0.20
Poland	3439	238	53	23	0.13
Portugal	1166	70	51	6	0.24
Romania	2773	308	35	19	0.13
Slovenia	2774	228	53	10	0.16
Slovakia	3160	173	55	20	0.14
Finland	5596	248	131	24	0.15
Sweden	5291	215	166	25	0.19
United Kingdom	2990	184	96	5	0.20
Norway	4963	215*	169	25	0.15
Switzerland	2996	198*	188	8	0.23
*Norway: same as in Sweden; Switzerland: same as in Austria					

5. RESULTS AND DISCUSSION

Figure 1 includes payback periods of deep renovations in European countries. Periods are calculated by using variables from table 1.

Example Netherlands

$$\text{Payback period} = ((I*Y/100)*((100+V)/100)) / (60 \% * X * Z)$$

$$= (190 \text{ €} * 114/100)*(121/100) / (60 \% * 152 \text{ kWh} * 0.16 \text{ €/kWh};a) \sim 17.7 \text{ years.}$$

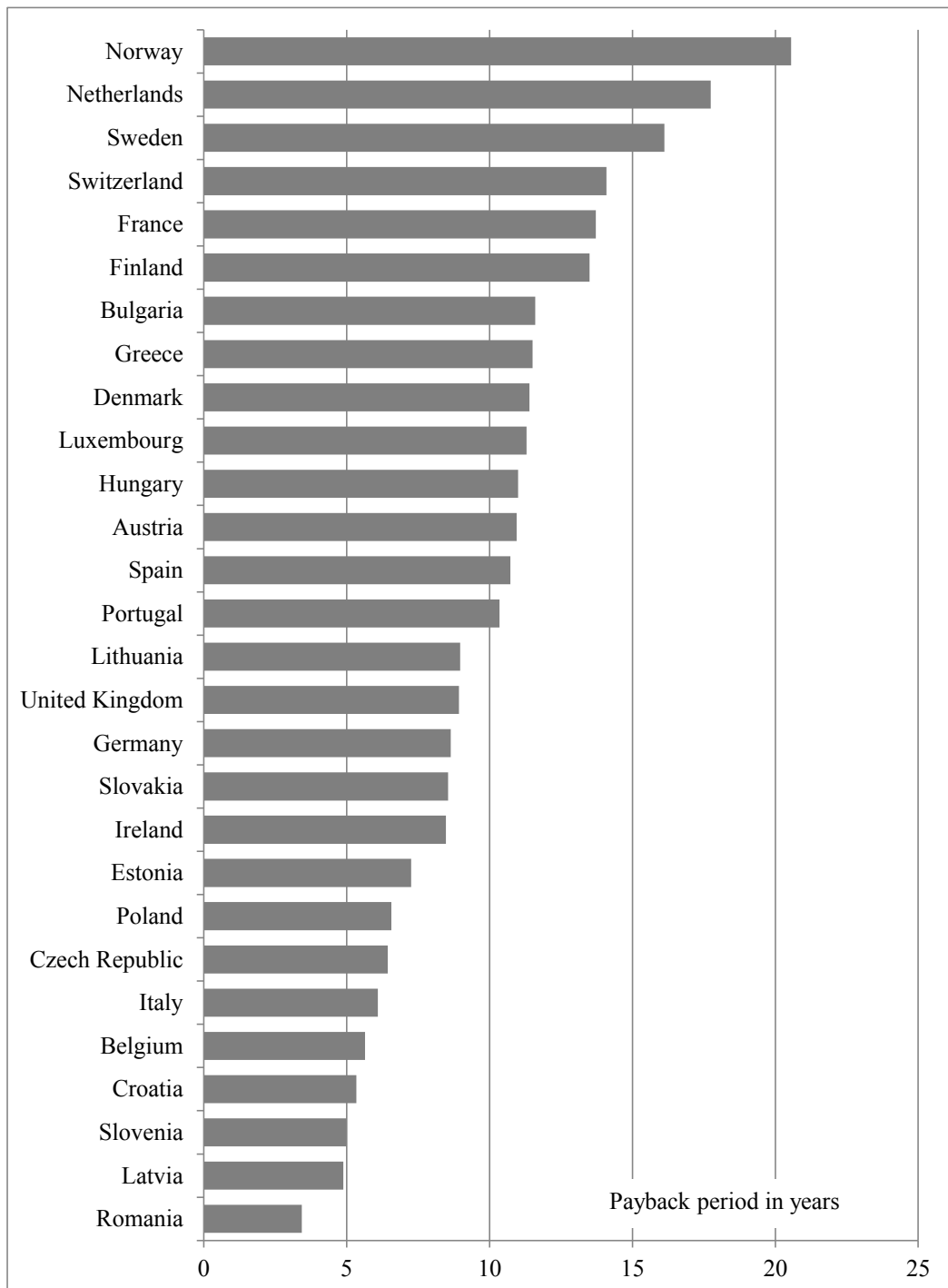

Figure 1: Payback periods

The longest payback period (20 years) is in Norway, where construction price level is high and energy relatively cheap. When we take account of the fact that over 99% of the electricity production in mainland Norway is covered by hydropower plants, motivation for deep renovation is understandably very weak.

The shortest payback period is in Romania, the electricity price is nearly as low as it is in Norway. But because the construction cost level is also low, the payback time is very short, only four years. If we take account of the purchasing power parity, the affordability of reparation gets a new perspective.

Payback period 13–21 year (Northern and Central Europe)

This includes Norway, Netherlands, Sweden, Switzerland, France and Finland. All these countries have quite high residential construction price levels (114–188 index EU27) compared to other countries. They have also all quite cheap electricity prices (0.15-0.19 euro/kWh; with the exception of Switzerland with 0.23 euro/kWh). Together these cause a long payback period for deep renovation package.

Payback period 9–12 year (Central and Southern Europe)

The majority main part of Central European and Southern European countries are in this category. These countries have either the lowest or the highest electricity price (0.10-0.30 euro/kWh). Residential construction price level is either low or average in these countries. The only exceptions are Denmark and Germany.

Payback period 3–8 year (Eastern Europe, Italy and Belgium)

In this category are: Estonia, Poland, Czech Republic, Italy, Belgium, Croatia, Slovenia, Latvia and Romania. The specific energy consumption of residential buildings is rather high, 175–308 kWh/m²,a. The construction price level is quite low (index= 35–74; with the exception of Belgium, 99). Also, these countries have rather low electricity prices (0.12–0.16 euro per kWh, with the exception of Italy and Belgium, which have higher electricity prices).

6. CONCLUSION

Energy Efficiency Directive (EED) article 4 obligates countries to deep renovations or staged deep renovations of the existing buildings even if there is no common definition and content for “deep renovation”. Unofficial definitions estimate that deep renovations should save around 60–75 percent energy (heating energy, cooling, ventilation, hot water, electricity for building services).

Deep renovation payback periods are, generally speaking, long in Northern European countries and some middle European countries because of rather cheap energy and high construction cost. The payback periods are short in Eastern European countries and in Italy and Belgium. The reasons for this are high energy consumption (kWh/m²,a), low construction price level and low energy price level.

Financial costs are excluded from the payback period analysis. If a loan (interest) is included in the investment cost to be covered by energy savings, the payback period would be a little longer. Even though interest rates are above the average European level in Eastern Europe (~3.5 %), payback periods still stay so reasonable that renovations should be carried out immediately.

A structural renovations target is difficult and costly to achieve in most of the European countries. The goal is almost achievable in cases where the initial energy consumption is very high. The second question is whether it is worth repairing such weak buildings. This question is justified both in depopulation areas and in growing cities.

The goal can more easily be achieved if savings can be generated by replacing bought energy by native energy production or by replacing fossil fuels by RES (geothermal energy, wind power, solar power, biofuels). In these cases energy needs and structural performance of building - except energy procurement system - stays the same.

Most European countries have efficient centralized energy production (district heating, hydro power, nuclear power networks) and distribution systems. Local RES production challenges this system but also secures energy supply. Parallel systems can be seen as a positive development even if they are also overlapping investments from the viewpoint of the national economy. Also, too big a distributed PV and geothermal energy production may cause problems in the form of sharp electricity demand peaks. Germany and Denmark are already planning to limit densified PV production.

7. REFERENCES

- Artola, I., Rademaekers, K., Williams, R., Yearwood, J., *Boosting Building Renovation: What potential and value for Europe?*, European Parliament. Directorate General for Internal Policies., 2016. doi:10.2861/331360.
- Boermans, T., Bettgenhäuser, K., Offermann, M., Schimschar, S., 2012, *Renovation tracks for Europe up to 2050. Building renovation in Europe - what are the choices?*
http://www.eurima.org/uploads/ModuleXtender/Publications/90/Ecofys_X_leaflet_05_10_2012_web_Final.pdf.
- Economidou, M., Laustsen, J., Ruyssevelt, P., Staniaszek, D., Strong, D., Zinetti, S., 2011, *Europe's Buildings under the Microscope*, Buildings Performance Institute Europe (BPIE), Brussels.
- EU (2010) Directive 2009/28/EC - The use of energy from renewable sources (Available online <http://eur-lex.europa.eu/legal-content/EN/TXT/PDF/?uri=CELEX:32009L0028&rid=1> [accessed 28/11/2016])
- EU (2010) Directive 2010/30/EU - The indication by labelling and standard product information of the consumption of energy and other resources by energy-related products (Available online <http://eur-lex.europa.eu/legal-content/EN/TXT/PDF/?uri=CELEX:32010L0028&rid=1> [accessed 28/11/2016])
- EU (2010) Directive 2010/31/EU - The energy performance of buildings (Available online <http://eur-lex.europa.eu/legal-content/EN/TXT/PDF/?uri=CELEX:32010L0031&rid=1> [accessed 28/11/2016])
- EU (2010) Europe 2020 - A European strategy for smart, sustainable and inclusive growth (Available online https://ec.europa.eu/info/european-semester/framework/europe-2020-strategy_en [accessed 28/11/2016])
- EU (2012) Directive 2012/27/EU - The energy efficiency (Available online <http://eur-lex.europa.eu/legal-content/EN/TXT/PDF/?uri=CELEX:32012L0027&rid=1> [accessed 28/11/2016])
- EU (2013) Commission staff working document - Financial support for energy efficiency in buildings (Available online https://ec.europa.eu/energy/sites/ener/files/documents/swd_2013_143_accomp_report_financing_ee_buildings.pdf [accessed 11/12/2016])
- EU (2014) A policy framework for climate and energy in the period from 2020 to 2030 (Available online <https://ec.europa.eu/energy/en/topics/energy-strategy/2030-energy-strategy> [accessed 28/11/2016])
- Fabbri, M., De Groote, M., Rapf, O., 2016, *Building renovation passports. Customised roadmaps towards deep renovation and better homes*, http://bpie.eu/wp-content/uploads/2017/01/Building-Passport-Report_2nd-edition.pdf.
- Morishita, N., Heidenreich, M., Hemmers, R., Vankann, M., Sahakari, T., Vainio, T., Treberspurg, M., Öttereicher, D., 2016, *EU-GUGLE: A sustainable Renovation for Smarter Cities from a Pilot Project*, Smart and Sustainable Planning for Cities and Regions p. 353-382.
- Sajn, N., 2016, *Energy efficiency of buildings: A nearly zero-energy future?*, <http://www.csa.com/partners/viewrecord.php?requester=gs&collection=TRD&recid=20080322014046EA>

Shnapp, S., Sitjà, R., Laustsen, J., 2013, *What Is a Deep Renovation Definition?*

http://www.gbpn.org/sites/default/files/08.DR_TechRep.low_.pdf.

UN (2015) Paris agreement (Available online:

http://unfccc.int/files/essential_background/convention/application/pdf/english_paris_agreement.pdf
[accessed 28/11/2016])

Data sources

EU, EU, Building Stock Observatory, <https://ec.europa.eu/energy/en/eubuildings>

Eurostat, Comparative price levels for investments, http://ec.europa.eu/eurostat/statistics-explained/index.php/Comparative_price_levels_for_investment

Eurostat, Energy price statistics, http://ec.europa.eu/eurostat/statistics-explained/index.php/Energy_price_statistics

Eurostat, Heating degree-days, http://appsso.eurostat.ec.europa.eu/nui/show.do?dataset=nrg_esdgr_a&lang=en

European Union VAT rates, <http://www.vatlive.com/vat-rates/european-vat-rates/>

FACTORS CAUSING DIFFERENTIATION IN BUILDING MATERIAL PRICES IN SOUTH AFRICA: THE PERSPECTIVES OF RETAILERS

A. Windapo

Department of Construction Economics and Management, University of Cape Town, South Africa

Email: Abimbola.windapo@uct.ac.za

Abstract: This study examines the factors causing differentiation in building material prices between locations in South Africa. The rationale for the study stems from previous research that shows that there are significant differences in building material prices in South Africa and that there is limited research that investigates the causes of building material price variation from retailers perspectives. The study employs a quantitative research approach, based on a survey research design. The data gathered was analysed using descriptive statistics. The study established that from a ranking perspective, the top three factors causing variation in building material prices in South Africa are transportation costs, energy costs, and crude oil prices while the retailers perceived that competition, supply and demand have limited effect on the variation in building material prices across South Africa. Based on these findings, the study concludes that variation in the prices of building material will increase proportionally to the distance of the source of the material from the retail store or location where the material is finally required. The paper recommends that government reduce taxes on manufacturers and retailers that are located in areas that require long haulage to harmonise prices across the country. However, further research is needed to match factors to locations, manufacturers, and retailers using GIS technology.

Keywords: Building Material, Price Variation, Retailers, South Africa, Transportation

1. INTRODUCTION

The study investigates the factors causing differentiation in building material prices between locations in South Africa from the perspectives of retailers. According to Ridley (2005), price differentiation is a situation when different prices are charged to different consumers for the same product by different sellers (or retailers). Several reports (cidb, 2007; AECOM, 2014; and Compass, 2016) have demonstrated a difference in building material prices across locations in South Africa. However, there is limited research that investigates the causes of the differentiation from the retailers' perspectives. Thisse (2009) posits that the differences in the prices of building materials found to vary across different locations in most countries pose a problem to the performance of the construction industry. Therefore, this study is a first study to understand the factors causing differences in prices across locations towards proposing measures that will bring about consistency in building material prices across South Africa.

2. REVIEW OF FACTORS CAUSING DIFFERENTIATION IN BUILDING MATERIAL PRICES

The factors that contribute to the differentiation in building material prices are subdivided into four main groups namely, economic, production, location and transportation factors.

2.1 Economic factors

Parkin (2013) posits that economic factors are factors that affect the distribution, production or trade between different areas. The main economic factors that cause differentiation in building material prices are exchange rates, import duties and inflation (Editor, 2007; Al-Shaibany, 2008; Odhiambo, 2008; Hamsawi, 2011; MBAM, 2011). Windapo and Cattell (2014) defines the exchange rate as the amount for which one currency is exchanged for another. A substantial amount of building materials used in the South African construction industry is manufactured locally. However, some raw materials used in the production of the building materials, are imported from other countries (cidb, 2007). Furthermore, the exchange rate plays a major role in the price of materials such as copper, bitumen, steel and timber that are traded on the Johannesburg Stock Exchange (cidb, 2007).

Import duties are defined by the National Treasury of South Africa (2010) as a charge on goods and products brought to South Africa. Import duties are used to protect local manufacturers from cheaper goods and products coming from other countries. Import duties on building materials have been found to cause price differentiation of building materials (Editor, 2007; Al-Shaibany, 2008; Odhiambo, 2008; Hamsawi, 2011; MBAM, 2011), especially between imported and locally manufactured goods. Inflation is an upward trend in the prices of goods and services within an economy (Fichtner, 2011). Fichtner (2011) states that inflation serves as a good measure on how the prices of goods and services change over time. Inflation is affected by two major forces namely, pull inflation and cost push inflation. Inflation affects the demand and supply of building materials. Materials such as steel and copper that cannot be substituted are prone to be affected by demand and supply shocks caused by inflation (Rakhra and Wilson, 1982).

2.2 Production factors

The term production factor is an economic term that identifies those elements that affect the inputs used in the production of goods or services to make an economic profit. The production factors that influence the variation of building material prices include the availability of raw materials, energy cost and the price of crude oil. The existence of raw materials within a certain geographical location may cause a price variation of building materials. Raw materials may need to be imported or sourced out from other places causing an increase in the final product (Iyengar, 2011; Prior, 2011). The farther the raw materials need to be sourced from the manufacturing plant, the more the materials will cost, leading the manufacturers to increase the price of the final product (Windapo and Cattell, 2014).

An increase in the price of electricity cost causes the manufacturers to increase the prices of building materials (Windapo and Cattell, 2014). BER (2014) noted that high energy cost affects the production process of building materials and manufacturers have to increase their price to wage off the growth in production cost. Countries with high energy cost tend to have high prices while countries with lower energy cost tend to have lower prices (BER, 2014). Global crude oil prices are crucial factors in the price variation of building materials. Oil and its derivatives are utilised in the manufacturing of building materials such as PVC and bitumen (BER, 2014). Furthermore, fuel which is a derivative of oil is used to power vehicles that transport building materials. High fuel prices in South Africa lead to an increase in the price of building material while low fuel prices result in the decrease of prices (Laing et al., 2011).

2.3 Location factors

The factors categorised as location factors are collusion, competition, monopoly, income level, and supply and demand. Collusion is defined as non-competitive secret or sometimes illegal agreement between rivals that attempts to disrupt the market's equilibrium (Telser, 2016). The parties may collectively choose to restrict the supply of a good or agree to increase its price to maximise profits (Telser, 2016). (Telser, 2016). In emerging countries like South Africa, retailers may divide an area into separate territories, where each has a monopolistic position and can set their prices (Backman, 2016). Also, the number of competitors in a certain location will cause price variation of building materials across different places (Porter, 1998). Manser (2012) states that in competitive location retailers and manufacturers tend to quote the price as low as possible. A complete advantage can be created by factors such knowledge, relationships and motivation (Porter, 1998).

Monopolies are created when retailers or manufactures have no rivals or competition in a certain location and do not worry about competitors entering the market (William, 1982). Monopoly tends to set the price where marginal cost equal marginal revenue which is rare in a competitive market. Locations with monopolies tend to have higher prices than competitive locations creating a price variation (Andy, 2012). Furthermore, Guy (1952) states that there is a tendency that higher income groups buy more expensive commodities creating a price variation between low-income locations and high-income locations. For example, employees in Gauteng earn R3633 and earn R2,700 and R2,487 in the Western Cape and KwaZulu-Natal respectively. According to Statistics South Africa (2010), the prices of goods will be higher in provinces where employees earn more and cheaper in provinces where employees earn less.

Demand and supply for building materials can contribute to the variation of building materials prices in an economy. An increase in demand for materials will result in an increase in their supply hence leading to low market prices (Julian, 2014; Windapo and Cattell, 2014). Building material price increases are dependent on the market conditions under which they are supplied or demanded. Windapo and Cattell (2014) argued that materials produced by one or two companies have more rapid and higher price increases compared to materials produced by several manufacturers.

2.4 Transportation

NIOS (2014) acknowledged that transportation cost is a major contributor to the differentiation in prices. Transportation cost is affected by the distance, the weight of the materials being carried, the fuel price and the state of the road. According to Sinclair et al. (2002), increased material costs are primarily due to increased transport charges. Windapo and Cattell (2014) established that high transport and freight costs are the main factors responsible for building material price increases and variation in South Africa.

3. CONCEPT OF THE STUDY

Figure 1 illustrates the concept of the study and highlights a summary of the factors identified in the literature as being responsible for price differentiation across locations.

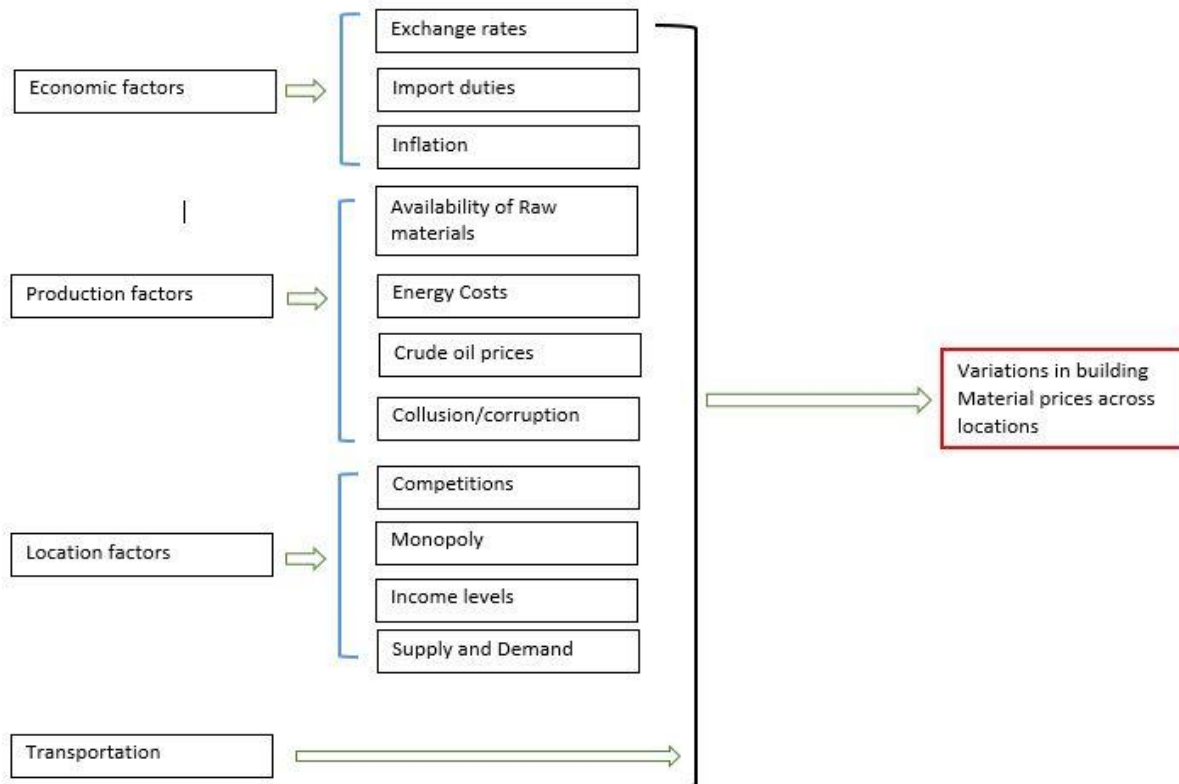

Figure 1: Conceptual framework

The conceptual framework in Figure 1 shows that there are four main factors affecting the price variation of building materials across different locations namely economic factors, production factors, locational factors and transport. Each main factor has been subdivided into sub-factors which directly influence the price variation.

4. RESEARCH METHOD

The research aims to examine the factors that cause differentiation in building material prices between locations in South Africa. The study made use of the survey approach sent to five main retailers (labelled A, B, C, D and E) in South Africa. The quantitative research approach was employed for the purpose of this study. Quantitative research involves explaining phenomena by collecting numerical data that are analysed using mathematically based methods (Muijs, 2011). The Quantitative research approach is used to investigate the relationship between facts and variables and applies to phenomena that can be expressed through quantity (Kothari, 2004). The quantitative method of data collection incorporated the use of both a questionnaire survey and telephone inquiries. This is in concurrence to Lunenburg and Irby (2008) who recommended the use of several sources or methods of data collection to connect the questions asked to the data collected and conclusions drawn.

The survey population was construction industry specific focusing on the five top retailers located in Kwazulu-Natal, Gauteng and The Western Cape. A population of 588 retailers was selected to obtain the required statistically acceptable response rate and sample size. A total of 75 retail branches of the five main retailers in South Africa answered the questionnaire which constituted the sample size. The 75 responses were gathered through a telephonic interview of the five main retailers as shown in Table 1.

Table 1: Number of responses distributed by province and retailers

Province	Retailers					Total
	A	B	C	D	E	
Kwazulu Natal	1	5	5	6	5	22
Gauteng	3	6	6	5	5	25
Western Cape	7	5	6	5	5	28
Total responses	11	16	17	16	15	75
Percentage Response	15%	21%	23%	21%	20%	100%

Table 1 shows that the highest response was obtained from Retailer C, representing a response rate of 23%. Another 21% of the sample population responded from Retailer B and Retailer D followed by 20% for Retailer E and 15% of responses were obtained from Retailer A. A total of 28 responses were gathered from retailers in the Western Cape, 25 from Gauteng and 22 from KwaZulu-Natal. The questionnaire was set up in a way that allowed the retailers to indicate the level of effect on a Likert scale of 1 to 5, where 1 represents very low, and 5 represents very high, the identified factors causing variation in building material prices in South Africa.

This study focused on five primary building materials used in the construction industry namely, cement, clay bricks, steel, timber and bitumen. It was necessary to select a sample of materials because so many materials are used in the industry that not all can be analysed in this study. These particular materials were chosen based on Horvath (2004) and Felix et al. (2014) who stated that cement, clay, bricks, steel, timber and bitumen are the most common building materials used in construction. In addition, these same materials have the most volatile prices in the industry (cidb, 2007; Laing et al., 2011; Windapo and Cattell, 2014). The data collected from the empirical survey was analysed using the Mean Item Score descriptive technique.

5. DATA PRESENTATION

The results of the study and data analysis performed are presented in this section.

5.1 Materials price variation per province and extent of variation

Table 2 presents the average prices of the selected five building materials from the three provinces studied in South Africa. It can be seen from Table 2 that the prices in the Western Cape generally showed a greater price variation for the selected building materials compared to KwaZulu-Natal. Table 2 further shows a positive price variation in cement at 41.99% and 0.94, steel at 25.40% and 6.77%, timber at 2.41% and 26.31% and clay bricks at 138.53% and 87.74% between Gauteng, as the base, and Western Cape and KwaZulu-Natal respectively. It also reveals a high negative average price variation for bitumen at 42.58% between Gauteng and Western Cape and 22.21% between Gauteng and KwaZulu-Natal. The next sub-section presents the data on factors affecting building material price variation from the retailers' perspective.

Table 2: Materials price variation per province and extent of variation in 2016

Province	Cement per Tonne	Steel per Tonne	Timber per m ³	Clay Bricks per 1000 bricks	Bitumen per 1000 litres
KwaZulu-Natal	R 1,414.07	R 14,435.75	R 6,839.03	R 2,935.91	R 22,797.36
Variation in %	0.94%	6.77%	26.31%	87.74%	-22.21%
Gauteng	R 1,400.96	R 13,520.42	R 5,414.53	R 1,563.79	R 29,306.32
Variation in %	0%	0%	0%	0%	0%
Western Cape	R 1,989.26	R 16,954.21	R 5,545.19	R 3,730.16	R 16,828.52
Variation in %	41.99%	25.40%	2.41%	138.53%	-42.58%

5.2 Factors influencing building material price variation

The study sought to know the perspectives of the building material retailers as per the factors responsible for the variation in building material prices within the selected provinces of South Africa. Data collected regarding this enquiry is presented in Table 3 and Figure 2.

Table 3: Factors causing the variation in the prices of building materials

Factor	Level of effect on building material prices					Response Count	Mean Item Score (MIS)	Rank
	Very Low	Low	Medium	High	Very High			
Transportation	0	0	4	29	24	57	0.87	1
Energy costs	1	7	29	16	1	54	0.63	2
Crude oil prices	1	11	33	10	1	56	0.60	3
Exchange rates	1	22	27	5	0	55	0.53	4
Raw materials and input costs	8	17	26	3	0	54	0.49	5
Inflation	12	19	16	8	0	55	0.47	6
Supply and Demand	6	30	21	0	0	57	0.45	7
Competition	8	29	15	4	0	56	0.45	7
Import duties	10	24	15	3	0	52	0.44	9
Income levels	15	26	13	0	0	54	0.39	10
Collusion	28	21	5	0	0	54	0.31	11
Monopoly	39	17	0	0	0	56	0.26	12

Table 4 and Figure 2 show that from a ranking perspective, the retailers viewed transport as the factor that has the greatest effect on the variation in prices of building materials across locations in South Africa with a Mean Item Score (MIS) of 0.87. Other factors like energy costs

and crude oil prices were considered to have a high effect on the variation in prices of building materials as shown by their Mean Item Scores which is greater than 0.6. The respondents ranked monopoly, collusion and income levels prevalent at the location of their stores to have the least effect on the variation of building materials as they have MIS scores less than 0.40. Meanwhile, macro economic factors which affect all materials notwithstanding location including import duties, supply and demand and competition were perceived to have a low effect on variation in building material prices.

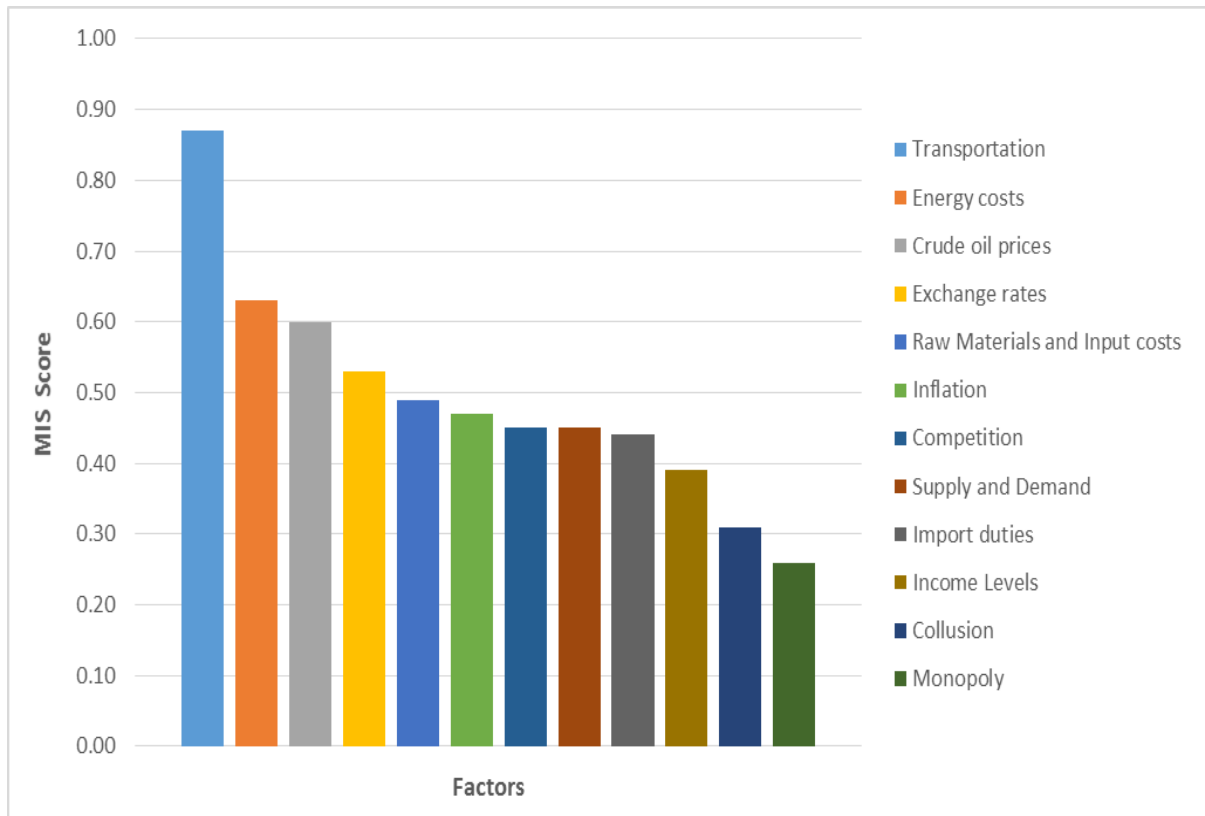

Figure 2: Factors affecting price variation of building materials in South Africa

6. DISCUSSION OF FINDINGS

It emerged from the study that the prices of building materials vary across different locations in South Africa. This finding confirms that there is significance price variation of building materials across different places. As seen in Table 2, the Western Cape has the highest average price of cement, steel and clay bricks, followed by the KwaZulu-Natal. Table 2 also shows that for timber, KwaZulu-Natal has the highest average cost followed by the Western Cape and Gauteng. The average of price for bitumen also indicates that the price is not the same in all three provinces. As illustrated by Table 2, Gauteng has the highest average price, followed by KwaZulu-Natal and The Western Cape.

The study then sought to establish from the five primary building material retailers in South Africa the factors causing the variation in prices of building materials and whether this is consistent with the literature that the number of competitors in a certain location will cause price variation because retailers and manufacturers would tend to quote prices as low as possible (Porter, 1998 and Manser (2012) - Gauteng has more branches of the five main retailers than the Western Cape and KwaZulu-Natal provinces creating competition among the

retailer branches in the province (i.e. Guateng); and the availability of materials within a certain geographical location is also identified as a source of price variation given the need to import the materials from other places (Iyengar, 2011; Prior, 2011) – for example, timber is not found in all South African provinces. Furthermore, the monopolies enjoyed by the branches of retailers or manufacturers who have no rivals or competition in certain locations tends to set the price at higher prices than competitive locations (William, 1982; Andy, 2012) a case in point will be the variation in the price of bitumen and the monopoly of refineries.

The study established that the factors that are causing price variation in building material prices from the perspectives of the five main retailers in South Africa are mainly transportation and production factors - energy costs and crude oils prices. These findings are aligned with earlier research done by Rakhra and Wilson (1982); Felix et al. (2014); and Windapo and Cattell (2014). It emerged from the study that factors such as competition, collusion and monopoly are perceived to have little effect on the price variation of building materials. This implies that factors, which are mainly out of the control of retailers are responsible for the variation in building material prices across South Africa and policies will be required to help standardise building material prices.

7. CONCLUSIONS

This study examines building material price variation across different geographical locations in South Africa and the factors causing the variation in the price of building materials between the various locations from the perspectives of major retailers. The study established that there is variation in the price of building materials across different places in South Africa. The result also shows that the key driver of the variation in the building material prices from the perspectives of the main retailers is transportation cost. Based on this finding, the study concludes that variation in the prices of building material will increase proportionally to the distance of the source of the material from the retail store or location where the material is finally required.

In order to reduce the impact of transportation costs on the price variation of building materials across different places in South Africa, and enable a level playing field for contractors and on National projects like roads that cuts across many provinces, the paper proposes that the government either provides the building material retail outlets that are located in remote areas where prices are high with tax incentives or reduce taxes on products that are manufactured in remote locations that require longer haulage, so as to harmonise prices across the country. The government also needs to maintain an efficient road and rail network to reduce the impact of transportation on the price variation of building materials in the country. It is also recommended that further studies should be carried out to match factors to locations, manufacturers and building material retail outlets using GIS technology.

8. REFERENCES

- AECOM, T.C. (2014) Property and Construction Handbook International. In, London.
- Al-Shaibany, S. (2008) Oman mulls import duty cuts on building materials In
- Andy, S. (2012) Principles of Economics. In: Saylor Academy.
- Backman, J. (2016) The Causes of Price Inflexibility In Oxford Journals.
- Bureau of Economic Research (BER). (2014) Report on Building Costs- First Quarter. Stellenbosch:
- Compass (2016) Global Construction Cost Yearbook. 16th Annual Edition ed. Morrisville, Pennsylvania, USA:

- Compass International Consultants Inc.
- Construction Industry Development Board (cidb). (2007) *The Building and Construction Materials Sector, Challenges and Opportunities*. Pretoria: Construction Industry Development Board (CIDB).
- Editor (2007) *To keep price and supply of cement on track, import duty scrapped*
- Felix, O., A, Moses, O., A and Sodiq, B., O (2014) *Comparative Study of Price Variations of Basic Civil Engineering Construction Materials*. *Energy and Environment Research*, 4(No. 3), 50-57.
- Fichtner, P. (2011) *Inflation and Solvency Models - Are we missing Something?* Deloitte.com. In.
- Guy, B. (1952) *Variations in Prices Paid for Food as Affected by Income Level*. *Journal of Farm Economics*, 34(No.1), 52-66.
- Hamsawi, R. (2011) *Builders Seek Import Duty Cut*. In.
- Horvath, A. (2004) *Construction Materials and the Environment*, 181-200.
- Iyengar, S.P. (2011) *High raw material costs to hit Q4 profits of cement companies*. In.
- Julian, A. (2014) *Reducing Material Demand in Construction*. United Kingdom: University of Cambridge.
- Laing, P., Marcus, G. and Dhansay, A. (2011) *Factors Determining the Volatility of Building Material Prices in the Construction Industry*. Department of Construction Economics and Management, University of Cape Town.
- Manser, J.E. (2012) *Economics: a foundation course for the built environment* London, United Kingdom: E & FN.
- MBAM. (2011) *Builders ask Govt to liberalise imports of building materials* In.
- NIOS. (2014) *Transport*. In: *Open Schooling*, London.
- Odhiambo, A. (2008) *Cement Firms Gear Up for Battle As Import Duty is Cut*. In.
- Parkin, M. (2013) *Global and Southern African Perspectives*. 2nd ed. South Africa: Pearson Education
- Porter, M.E. (1998) *Location, Clusters, and the New Microeconomics of Competition*. *Business Economics*, 76,76,77-90.
- Prior, G. (2011) *Icopal hikes prices by 10% as raw material costs soar*. In.
- Rakhra, A. and Wilson, A.J. (1982) *Inflation, Budgeting and Construction Costs*. *Building Research Note*, 197, 18.
- Ridley, D.B. (2005) *Price differentiation and transparency in the global pharmaceutical marketplace*. *Pharmacoeconomics*, 23(7), 651-658.
- Sinclair, N., Artin, P. and Mulford, S. (2002) *Construction Cost Data Workbook*. In *Proceedings of Proceedings of Conference on the International Comparison Program*, World Bank, March 11-14, 2002, Washington, D.C, USA.
- Statistics South Africa, S. (2010) *Monthly Earnings of South Africans*. Pretoria, South Africa.
- Telser, L.G. (2016) *Competition, collusion and game theory*. Springer.
- Thisse, J.F. (2009) *How transport costs shape the spatial pattern of economic activity*. OECD Publishing.
- William, C., Spaulding (1982) *Price Discrimination*. In.
- Windapo, A.O. and Cattell, K. (2014) *Evaluation of Location Factors Influencing Building Material Price Variation in South Africa*. In, ICEC 2014 Conference, 20-22 October, Milan.

W65: ORGANISATION AND MANAGEMENT OF CONSTRUCTION

PROJECT SCHEDULE OPTIMISATION FOR SAFETY MANAGEMENT IN CONSTRUCTION

M. Bragadin¹ and K. Kähkönen²

¹ Department of Architecture, Alma Mater Studiorum-University of Bologna, viale Risorgimento, 2, 40136, Italy

² Department of Civil Engineering, Tampere University of Technology, Korkeakoulunkatu 10, FI-33720 Finland

Email: marcoalvise.bragadin@unibo.it

Abstract: In construction project management, safety management processes are of capital importance for project success. Project schedule is the baseline for project control, therefore construction scheduling has to address safety related issues of construction activities. The schedule model should demonstrate that scheduled process provides a safe working environment to construction workers, in terms of interferences with other activities, space requirements, hazard protection and availability of temporary facilities. Therefore, avoiding time-space conflicts of activities is an important requirement to be fulfilled by project schedule. A schedule evaluation and optimisation procedure is proposed with the aim of improving safety management of construction process. Safety assessment and optimization of the project schedule is achieved converting the original schedule in an activity network plotted on resource – space chart and in a flowline chart, based on a Location Breakdown Structure. Therefore, time – space conflicts of activities related to trades and locations can be detected, and the safety of the scheduled processes can be improved. In the control phase, resource – space charts of the controlling schedule can provide useful documentation of the project status for construction safety coordination. The proposed schedule safety assessment and optimization procedure is performed on a case study of a building renovation project.

Keywords: Construction, Flowline, Health And Safety, Project Scheduling, Project Management

1. INTRODUCTION

Safety Management is a fundamental process of construction Project Management to achieve project success, and the Health and Safety plan constitutes the basic documentation for the safety of construction project operations. The Health and Safety Management process includes all activities to be performed by the owner and by the contractor which can realize safety policies and objectives to ensure that the project is planned and executed preventing accidents, which can cause personal injuries or even fatalities. Project Safety Management consists primarily that the conditions of the contract, and of the Health and Safety Plan (if available), are carried out to assure the safety of both those working on site and those who are in the vicinity of the project (PMI, 2007). The Health and Safety plan identifies the strategies and procedures to be used in the project with the aim of creating a safe working environment for construction operations (APM, 2006). Therefore, a safety – oriented schedule should be included in the Health and Safety plan (EC, 1997).

Project safety management applies to all aspects of project management, and in particular to Project Time Management, as safety dependencies between activities in the project schedule can be of capital importance in preventing accidents and hazard creation. The safety specialists, or health and safety coordinator as defined by the well-known 92/57/EU directive, should develop a safety-oriented project schedule and has to evaluate the contractor's schedule to assure that provisions of the Health and Safety Plan are implemented in the forecasted work flow of construction activities. In particular, hazard protection can be delivered analysing

safety dependencies between activities and activity interferences that can generate hazards, and time – space conflicts due to errors in workflow management or congested areas. In fact, some construction sequences have no technical interdependencies but, due to the proximity of the work areas, congested spaces, or safety issues, may cause injury risk to the crews (PMI, 2007). Therefore, construction project scheduling can be considered a fundamental component of safety design of the project execution stage, on site.

Surely, construction project safety performance depends on actual implementation of safety devices and procedures, but the relationship between project scheduling and construction safety is symbiotic, as the improvements in one generally result in improvements in the others (Veteto, 1994).

A little research work has addressed the safety management concern for construction scheduling, though project scheduling is a basic component of safety coordination. As Project Management entails health and safety management of a construction project, the master schedule and the baseline schedule should take into account safety-oriented requirements of the scheduled process. Many quality requirements have to be fulfilled by a construction project schedule, and surely some of them concerns the safety of the production process. The schedule model, in fact, should demonstrate that the scheduled process provides a safe working environment to construction workers in terms of activity interferences, space requirements, hazard protection and availability of temporary facilities.

In the research behind this paper an innovative procedure to evaluate time-space conflicts of activities in construction project scheduling has been developed. The proposed procedure has the aim of evaluating and improving the safety of project operations through the scheduling process.

2. SAFETY MANAGEMENT AND PROJECT SCHEDULING: A LITERATURE REVIEW

Planning and Scheduling is a key process of construction management, as it provides the roadmap for project execution and basis for project control (PMI, 2007). Project scheduling has also an impact on safety (Larsen, Whyte, 2013, Saurin et alii, 2004). In Europe, directive 92/57/EU (Temporary and mobile construction sites) requires an health and safety plan, and Suraji et al. (2001) found the planning and control failures related both to safety and production itself were major contributing factors to accidents in construction sites in the UK. In the U.S.A. Gambatese and Hinze (1999) collected over 400 design suggestions or best practices which could be implemented in the design phase in order to improve safety during construction, and 56 (more than 14%) suggestions belong to the discipline of construction management. Moreover, Hinze and Wilson (2000) has consistently found that pre-project and pre-task safety planning are among the critical measures required to achieve a zero accident target.

Veteto (1994) indicates that there are five project schedule – based factors highly correlated with a better safety performance. The factors are the following: a) the use of computer-based logic networks and resource-loaded schedules; b) the frequent updating of project schedules; c) the holding of coordination meetings often, thus maintaining good communication with all subcontractors; d) the holding of coordination meetings with subcontractors before the commencement of construction; and e) maintaining the project on-schedule.

Kartam (1997) presents a proactive safety environment, termed IKIS – Safety Integrated Knowledge Intensive System, for construction safety and performance control. The IKIS

system is based on the three E's of safety: engineering, education and enforcement. Engineering means to perform specific safety actions such as substituting hazardous materials with less hazardous ones, using warning devices and prescribing protective equipment. Education means the use of the proposed system as a teaching and training tool. Enforcement means to follow safety laws and regulations. The objectives of the research are to provide contractors with a tool to plan the safety measures and to provide owners with means to review a contractor's safety plan and monitor performance during construction. The proposed system develops a database system of safety and health standards and recommendations for project activities and integrates the safety and health information into the critical path method CPM – based project schedule. Activities of the schedule can be classified in explicit and implicit activities. Explicit activities are for instance safety milestones (e.g. “install first aid station”), while implicit activities have a link with the safety information database and are highlighted with a message “flag”.

Tam et alii (2002) propose a decision support system (DSS) for the evaluation of the construction management system. The major elements adopted in safety management are: a) safety audits; b) effective safety training; c) supervision competency; d) management involvement; e) safety promotion; f) safety policy; g) eradication of hazards. The key to enhance site safety is to manage the working environment keeping the current condition safe. Seven are also the decision criteria for the safety management system: time, cost, resources, company size, current legislation, quality of employee and project complexity. The proposed model provides a DSS for construction projects where the decision criteria are evaluated and weighted to show the relative importance of safety related components under each decision criteria.

Saurin, Formoso and Guimaraes (2004), present an innovative safety planning and control model (SPC), that integrates safety management to the production planning and control process, based on the concepts and principles used in construction production scheduling and control, particularly the Last Planner System by Ballard (2000). The integration of safety in construction planning and control takes place in three hierarchical levels: long-term planning, look-ahead planning and short-term planning. In long-term safety planning for each construction phase (e.g. bricklaying) a plan is produced using preliminary hazard analysis. In look-ahead safety planning a three week production schedule is developed with the aim of the identification of safety constraints. In short-term planning the workers' commitment for one day and one week is identified and safety measures are discussed. In daily meetings safety and production plans are re-evaluated and the client provides a work permit. Safety control is performed through performance indicators and workers participation interviewing groups of workers. The study indicates that long-term safety plans should be improved with the discussion of potential risks and should be systematically updated.

The seminal work of Akinci, Fisher, Levitt and Carlson (2002) investigated the time-space conflicts in construction projects. Six type of spaces required by construction activities were detected and each construction activity requires at least one of these spaces. As activities can have time overlaps, i.e. they can be performed at the same time, time – space conflicts may occur. Ciribini and Galimberti (2005) observed that the H&S Management has widely to deal with working areas and space conflicts. A schedule model should indicate crew workflow directions, space requirements, and spatial buffers between activities.

Yi and Langford (2006) observed that the work environment of construction sites varies according the progress of the project and therefore the schedule affects the occurrence of

hazardous situations, and the estimation of possible hazards must be coordinated with the project schedule. Hazardous locations and high-risk time periods of the project can be predicted if a safety-oriented schedule is developed. Therefore, it is possible to reschedule the start time of high-risk situation so that risks are not concentrated during certain periods and at certain locations. The authors present a risk-assessment method based on activity processes, construction locations and environmental factors.

Cameron and Hare (2008) investigated the integration of health and safety with construction project planning and developed eight integrated management tools for project team. One of the tools is a safety-oriented construction programme including activities and milestones required for the management of health and safety risks. As the programme is a tool to measure progress against time and to make sure that things get done, or at least to help to identify a problem if things are not done, it is important to include and schedule safety related activities and milestones. Moreover, the schedule can be used to highlight major risks in different phases of the project. The same authors (Hare and Cameron, 2012) develop a gateway model of a construction project to best promote the effective integration of health and safety management into construction project planning and control.

The optimization of the sequences of crews (workflows and production rates) can be done by scheduling work locations. Daewood and Mallasi (2006) and Mallasi (2006) observed that lack of execution pace planning may disrupt the progress of construction activities. Also, spatial congestion can severely reduce the productivity of workers sharing the same workspace, and may cause health and safety hazards to workers. A Critical Space-Time Analysis (CSA) approach is proposed to model and quantify workspace congestion and a computerized tool termed PECASO was developed for workspace management. The basic method suggested by researchers and practitioners for time – space project modeling is the linear scheduling method, flow line or linear planning, integrated with a network model (Kenley and Seppanen, 2010; Russell, Tran & Staub – French, 2014). Safety oriented scheduling should include safety dependencies between activities to avoid hazard creation and time/space dependent conflicts between activities (Akinci et alii, 2002, Bragadin and Kahkonen, 2015). Zhang, Teizer, Pradhananga and Eastman (2015) highlight safety and productivity poor performances of construction due to congested site conditions, and propose a method for automated visualization of workspace with BIM. Workspace modelling is based on five workspace sets and a conflict taxonomy.

In summary, it is felt that there is a lack of structured planning and scheduling method for the development of a safety-oriented schedule, at the owner and contractor level. Safety planning is an important concept and viewpoint for understanding safety characteristics of construction projects. The earlier research has covered already several important methodological characteristics of construction planning and scheduling with the site space on focus. Although not covered explicitly here some research has covered also computerized assistance for the generation of alternative plans and schedules – for example (Kahkonen, 1994) and schedule quality assessment. The research presented in the following aims at proposing a method to understand safety characteristics of a construction schedule focusing on time-space conflict of activities, thus creating a safety-oriented environment for construction schedule production, and enabling high quality scheduling.

3. TIME – SPACE CONFLICT DETECTION FOR SAFETY EVALUATION OF A CONSTRUCTION SCHEDULE

3.1 Time / space conflicts and health and safety hazards in construction projects

The most frequent hazards in construction projects fall into two main categories (Dias, 2009): a) hazards that may cause occupational accidents; b) hazards that may cause occupational illness. The leading accident hazards, in most construction projects and in most countries are the following:

- falls from height;
- caught in / caught between;
- cave in;
- electrocution;
- slips, trips, falls
- fire / explosion;
- struck by.

The leading occupational illness hazards in the construction industry of most countries are:

- respiratory diseases from inhaling dust, asbestos, fumes, atmospheric contaminants;
- back injuries and musculoskeletal disorders from material and manual handling;
- hand arm vibration syndrome;
- hearing losses, noise;
- skin diseases from manipulation of dangerous materials.

Interference hazards are hazards that are created by a construction activity and can be transferred to other contemporary and nearby activities. Therefore, in construction projects, hazards are time and space dependent. Each construction activity requires a time period and space to be performed, and as activities can have time overlaps, i.e. they can be performed at the same time, time – space conflicts may occur and safety hazards can be created (Akinçi et alii, 2002; Mallasi, 2006; Sacks, Rozenfeld and Rosenfeld 2009; Zhang et alii, 2015). Time – space conflicts have three characteristics:

- Temporal aspects of time-space conflicts: since activity space requirements change over time, time – space conflicts between activities only occur for certain periods of time.
- Multiple types of time – space conflicts: depending on the types of space conflicting and the quantity of interfering spaces, time – space conflicts can have many types: safety hazard; congestion; design conflict; and damage conflict.
- Multiple conflicts can exist between a pair of conflicting activities.

In the proposed method, three types of conflicts are identified for the safety evaluation of a project schedule:

- Time / space conflicts due to activities' time-space overlapping and consequent contemporary space usage that creates a congested space due to labor density. The increase of labor density can lead to safety hazards and productivity loss.

- Safety hazards due to hazard spaces created by an activity for labor crew spaces of other activities.
- Damage conflicts due to labor crew spaces, equipment space, temporary structure space, hazard space required by an activity conflicts with a protected space of another activity.

The main tool suggested by researchers and practitioners for time – space conflict resolution is the linear scheduling method, flow line or linear planning, integrated with a network model (Ciribini and Rigamonti, 1999; Kenley and Seppanen, 2010; Russell, Tran & Staub – French, 2014). The detection of time / space conflicts of a construction schedule can be facilitated plotting the schedule network model on a resource – space chart and displaying the correspondent flowline view.

3.2 Resource – Space charts and flowline view for construction scheduling

Resource – space charts can improve construction scheduling of a repetitive project (Yi, Lee and Choi, 2002). In an on-going research an improved scheduling method for construction project has been developed, based on a Precedence Diagram Network plotted on a Resource–Space chart termed Repetitive Networking Technique (REPNET) (Bragadin, Kahkonen 2016). Locations or Space Units of the project are identified by a Location Breakdown Structure (LBS), and project activities are identified by a two dimensions coordinate system based on Resources (i.e. construction crews) and working Spaces as identified by the LBS (e.g. floors of a multi-storey building). The network model plotted on the resource – space chart (figure 1), integrated with a flow-line view of the developed schedule is the proposed approach to evaluate time-space safety conflicts of a construction programme.

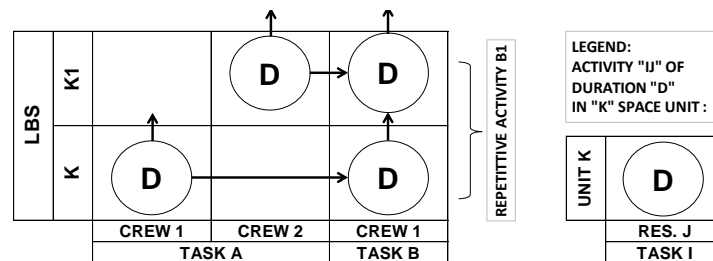

Figure 1: Network Diagram plotted on a Resource-Space Chart.

The proposed resource – space chart based method can help project planner and production managers to avoid conflicts in many ways. In fact, time-space conflicts can be avoided due to space allocation of activities in the resource-space chart, and PDM activities plotted on the resource-space chart give a clear definition of the space used by labor crew for working. At the same time the layout spaces needed for the operations of each activity are identified on the chart, and it is easy to detect congested spaces. In addition, safety hazard spaces and protected spaces can be represented as unavailable spaces directly on the resource – space chart plotted for a specific time window. Major limitation of the proposed solution can be found in the level of detail of the LBS, and the consequent space needs of activities and the representation of space conflicts between activities. The understanding of space conflicts needs a deep knowledge of the modelled construction process and a proper level of detail of work packages. Therefore, a 3D model of the building process could give important support in this phase (Akinci et alii, 2002, Ciribini and Galimberti, 2005, Dawood and Mallasi, 2002, Sacks,

Rozenfeld, Rosenfeld, 2009, Zhang et alii, 2015). Once the traditional network model has been plotted on a resource – space chart, safety assessment of the baseline schedule can be easily performed. In the control phase, resource – space charts of the controlling schedule can provide useful documentation of the safety project status for construction coordination.

3.3 Safety – oriented evaluation and optimisation of a construction project schedule

A procedure aimed at project schedule evaluation and optimization is proposed for safety management purposes. The procedure can be performed in the following five steps (figure 2).

Step 1. Activity hazard detection. Based upon the Health and Safety Plan, construction project hazards can be detected and interference hazards highlighted for each activity of the schedule.

Step 2. The Location Breakdown Structure (LBS) is created.

Step 3. A precedence network plotted on a resource – space chart and a flowline view for the project schedule are developed, and location-based (i.e. interference) hazards are highlighted.

Step 4. Time / space conflicts are detected, particularly focusing on the following:

- conflicts due to time-space overlapping of activities and consequent congested spaces;
- interference safety hazards;
- hazard spaces required by activities.

Step 5. Conflicts resolution and construction schedule project optimization, rescheduling.

The procedure can be performed in the design phase, for the development of a master schedule or for the safety – oriented project schedule to be included in the Health and Safety Plan, or in the bid phase, to evaluate the contractor’s detailed schedules, and finally during the construction phase, for project controlling purposes.

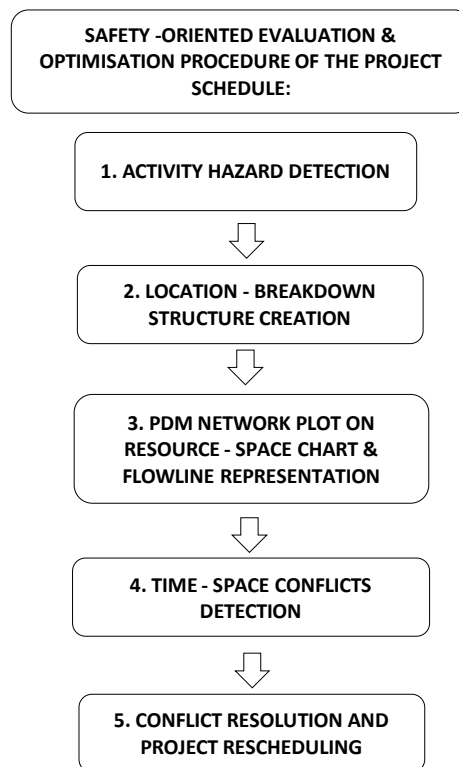

Figure 2: Proposed scheduling evaluation and optimisation procedure

4. CASE STUDY: EVALUATION AND OPTIMISATION OF A DETAILED SCHEDULE OF A REHABILITATION BUILDING PROJECT

A case study of an actual building rehabilitation project has been used to test the proposed procedure. The procedure has been applied to evaluate and optimise the project schedule prepared by the owner for the bid phase and included in the Health and Safety Plan. An excerpt of the owner’s schedule can be found in figure 3. Only the demolition and structural reinforcement phases are represented in the bar chart schedule, developed with MS Project®.

Table 1: Leading hazards of project activities

ID	ACTIVITY DESCRIPTION	HAZARDS												
		interference hazards	falls from height	caught in / between	cave in	electrocution	slips, trips, falls	fire/explosions	struck by	atmospheric contaminants	mat & manual handling	hand arm vibration	noise	Skin diseases
A	CEILINGS DEMOLITION	x	x		x	x					x	x	x	x
B	STAIRS & WALLS DEMOLITION	x	x	x	x	x					x	x	x	x
C	FLOORING AND WALL TILES REMOVAL					x					x		x	x
D	CEMENT SCREED DEMOLITION					x					x		x	x
E	TRENCH EXCAVATIONS	x			x	x	x	x	x	x	x			
F	REINFORCED CONCRETE WALLS OF LIFT SHAFT	x	x		x	x							x	x
G	REINFORCED CONCRETE SLAB					x	x					x		x
H	TIMBER FLOORS	x	x	x					x		x			
I	REINFORCED CONCRETE STAIRWAYS	x	x		x	x			x					x
L	BRICKWORK MASONRY WALLS		x	x					x		x			x
M	REINFORCEMENT OF BRICK MASONRY		x			x	x				x	x		x
N	STRUCTURAL STEEL	x	x	x		x			x				x	

Table 2: Location Breakdown Structure of the case study

PROJECT	FLOOR	SPACE UNIT DESCRIPTION	SPACE UNIT LBS CODE	SPACE UNIT ID
BUILDING REHABILITATION PROJECT	ROOF: 1.RO	AREA B	1.RO.B	10
		AREA A	1.RO.A	9
	1*F-FIRST FLOOR: 1.FF	AREA B	1.FF.B	8
		AREA A	1.FF.A	7
	GF-GROUND FLOOR: 1.GF	AREA B	1.GF.B	6
		AREA A	1.GF.A	5
	UG-UNDERGROUND FLOOR:	AREA B	1.UG.B	4
		AREA A	1.UG.A	3
	ST-STAIRCASES: 1.ST	STAIRS B	1.ST.B	2
		STAIRS A	1.ST.A	1

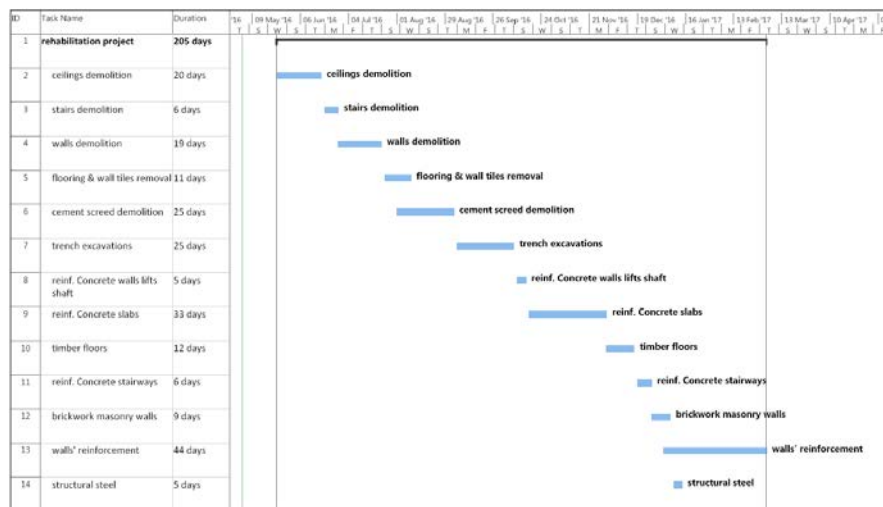

Figure 3: Excerpt of the owner’s project schedule, developed with MSProject®

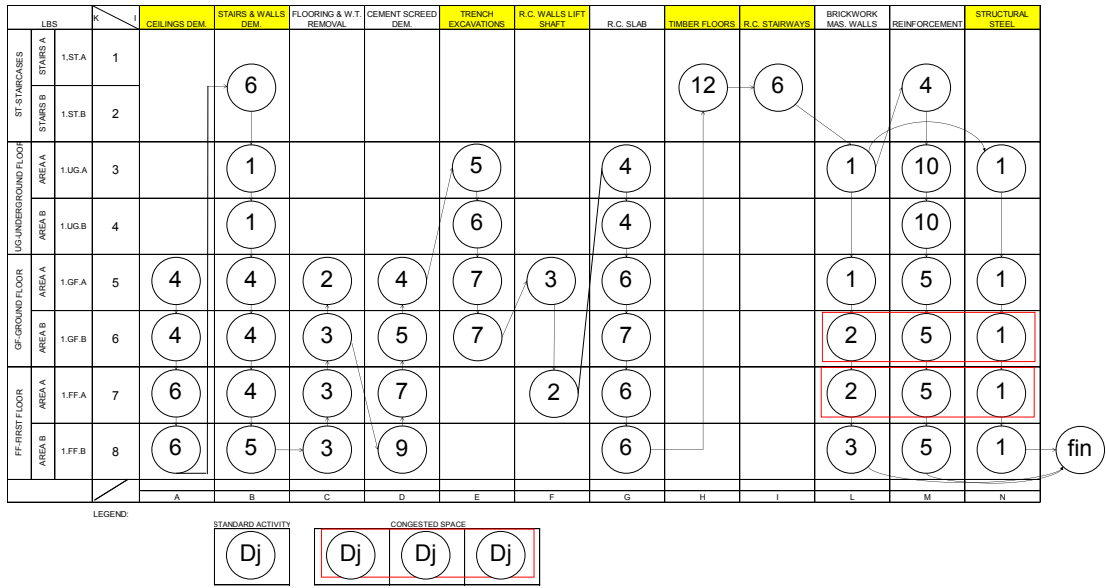

Figure 4: Resource – Space chart of the owner’s schedule

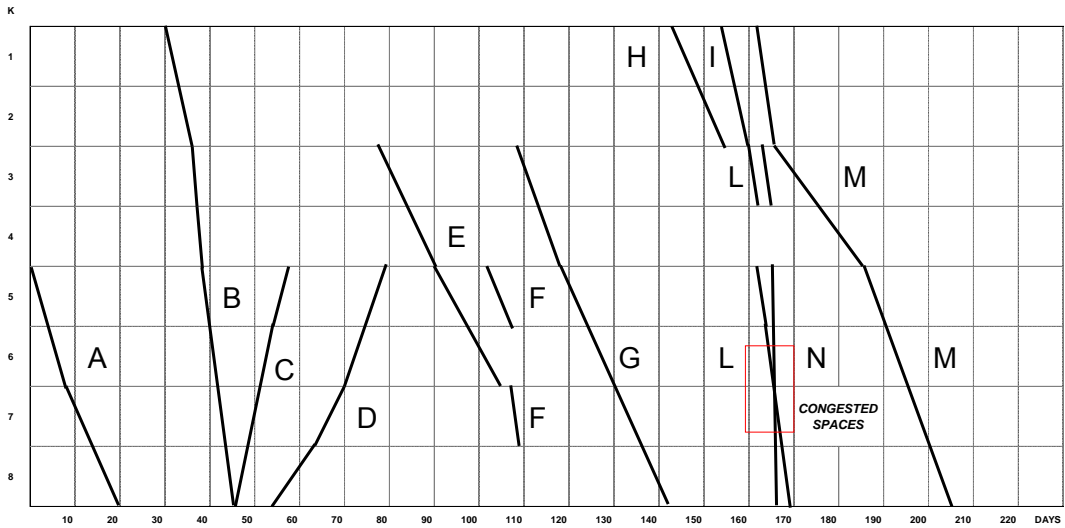

Figure 5: Flowline view of the owner’s schedule

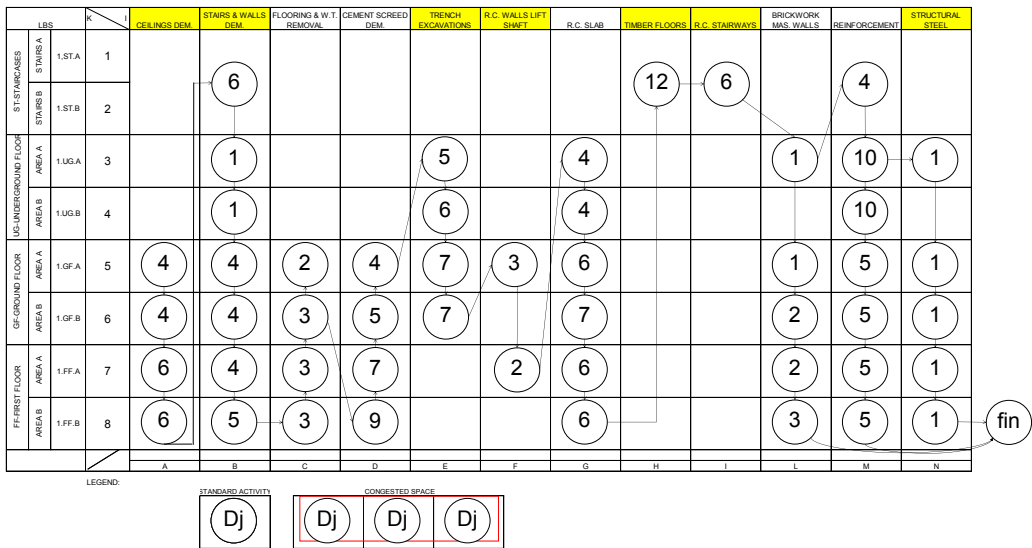

Figure 6: Resource – Space chart of safety-optimised schedule

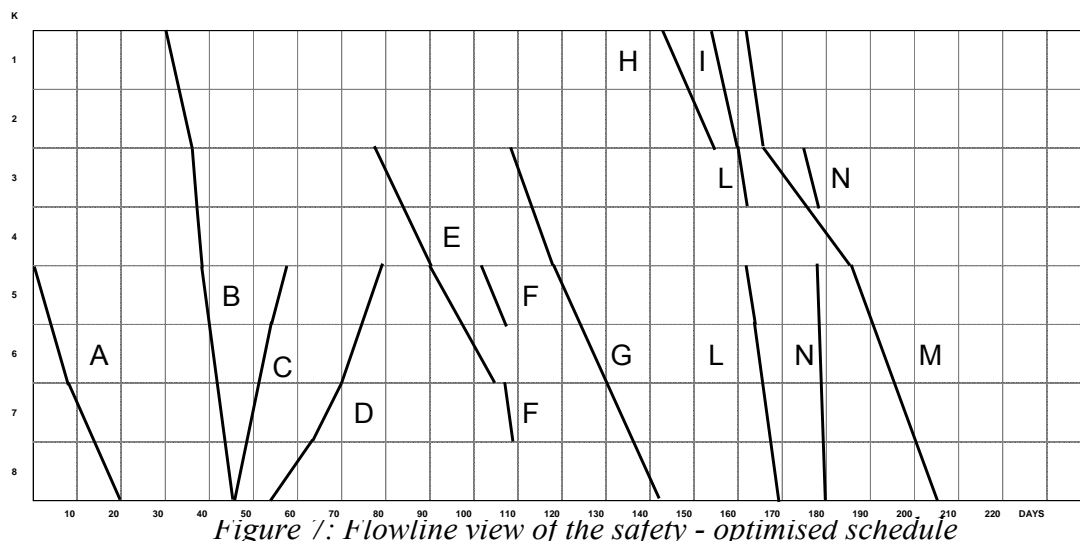

Figure 7: Flowline view of the safety - optimised schedule

In the original schedule, the sequence of project activities is regardless of working zones, and there are few time overlapping activities with the aim of avoiding the transmission of interference hazards. Although the original schedule has been already optimised for safety management purposes, as it was created by the safety coordinator, the proposed evaluation and optimisation procedure is performed in the following.

Step 1. The proposed procedure is applied to the project schedule of the demolition and structural reinforcement phases, and the leading hazards of activities, as detected in the Health and Safety Plan, are summarised and displayed in table 1.

Step 2. The Location Breakdown Structure of table 2 is developed by an accurate analysis of construction documents, and particularly of the Health and Safety Plan.

Step 3. The safety-oriented project schedule of the owner (figure 3) is analysed. The bar-chart is converted into an activity network schedule model. A more detailed schedule can be developed plotting the project network on the resource / space chart and creating detailed activities based upon the location – based quantities (figure 4). The found schedule model can be displayed also with a flowline view, to highlight time-space conflicts (figure 5).

Step 4. Time / space conflicts are detected between activities L (Brickwork masonry walls) and N (Structural steel), in the following locations: 1.GF.B (id. 6) i.e. ground floor area B; and 1.FFA (id. 7) i.e. first floor area A. The congested spaces are due to overlapping activities (L and N) in the same working locations (id. 6 and 7), as displayed in figures 4 and 5.

Step 5. Conflicts resolution can be easily performed shifting forward the start of activity N - structural steel, and inserting a finish to start logic link between activities L3 and N3 of the Resource – Space chart of figure 4. Therefore, the new safety - optimized schedule with no time – space conflicts can be displayed with a resource- space chart (figure 6) and with the flowline view (figure 7). No other conflicts are found in the schedule, and the optimisation procedure is completed.

5. CONCLUSIONS

Health and Safety requirements are fundamental factors of the planning and scheduling of a construction project. The project schedule of a construction project should take into account safety requirements of production processes, therefore contributing to safety management processes. A procedure to evaluate time – space conflicts of activities in the schedule model that can create hazardous situation for construction workers has been proposed. The procedure is mainly based upon hazard detection, creation of the Location Breakdown Structure and analysis of the schedule model to detect time-space conflicts. Activity networks, resource – space charts and flow-line charts are used with this purpose. The proposed procedure can be used to evaluate the safety management requirements of a project schedule concerning the avoidance of time – space conflicts between activities, and can facilitate a safety-oriented optimisation of the schedule, i.e. of the planned construction process. A safety-oriented construction schedule can be achieved in many ways, but the proposed procedure can help project schedulers, safety specialists or safety coordinators to deliver a good quality and safety-oriented schedule. In the project control phase, resource – space charts of the controlling schedule can be updated with actual dates and process logic, and therefore they can provide useful information concerning the project status for safety management actions. Further research will proceed to test the proposed procedure and will address the development of the approach with the Building Information Modelling (BIM) strategy.

6. REFERENCES

- Association for Project Management (2006). APM Body of Knowledge, fifth edition. Association for Project Management, UK.
- Akinci B., Fischer M., Levitt R., Carlson R. (2002). Formalization and Automation of time-space conflict analysis, *Journal of Computing in Civil Engineering*, 16 (2) pages 124-134. ASCE USA.
- Ballard G. (2000). The Last Planner System of Production Control. PhD thesis, School of Civil Engineering, University of Birmingham.
- Bragadin M.A., Kahkonen K. (2015) Safety, space and structure quality requirements in construction scheduling. *Procedia Economics and Finance*, vol. 21, pages 407-414. Elsevier B.V. the Netherlands.
- Bragadin, M. Kähkönen K. (2016). Resource – Space Charts for Construction Work Space Scheduling. *Proceedings of the CIB World Building Congress 2016 Tampere University of Technology*.
- Cameron I., Hare B. (2008). Planning tools for integrating health and safety in construction. *Construction Management and Economics* vol. 26, September 2008, pages 899-909.
- Ciribini A. Galimberti G. (2005) “4D Project Planning and H & S Management”, *Proceedings of CIB W78’s 22nd International Conference on Information Technology in Construction*, Dresden, Germany, CIB publication 304.
- Dawood N., Mallasi Z. (2006) “Construction Workspace Planning: Assignment and Analysis Utilizing 4D Visualization Technologies”, *Computer-Aided Civil and Infrastructure Engineering* vol. 21, 498-513.
- Dias, L. A. (2009). *Inspecting Occupational Safety and Health in the Construction Industry*. International Training Centre of the International Labour Organization (ILO), Turin, Italy
- EC (European Community) (1997) Council Directive 92/57/EEC of 24 June 1992 on the implementation of minimum safety and health requirements at temporary or mobile construction sites.
- Gambatese J., Hinze, J. (1999). Addressing construction worker safety in the design phase Designing for construction worker safety. *Automation in Construction*, 8 (1999) 643-649.
- Hare B. Cameron I (2012). Health and Safety gateways for construction project planning. *Engineering, Construction and Architectural Management*, vol. 19, issue 2 pp. 192-204.
- Hinze, J., Wilson G., 2000. Moving towards a zero injury objective. *Journal of Construction Engineering and Management*, 126 (5), pages 399-403.
- Kähkönen, K. (1994) Interactive Decision Support System for Building Construction Scheduling, *Journal of Computing in Civil Engineering*, 8(4), pp. 519-535
- Kartam N. A. (1997). Integrating Safety and Health Performance into Construction CPM. *Journal of Construction Engineering and Management*, Vol. 123, No. 2, June, 1997. ASCE USA.

- Kenley R., Seppänen O. (2010) *Location-Based Management for Construction: planning, scheduling and control*, Routledge, U.K., Spon Press, U.K.
- Larsen G.D., Whyte J., 2013. Safe construction through design: perspectives from the site team. *Construction Management and Economics* vol. 31, issue 6, pages 675-690.
- Mallasi, Z. (2006) "Dynamic quantification and analysis of the construction workspace congestion utilizing 4D visualization", *Automation in Construction*, 15 (2006) 640-655.
- Project Management Institute PMI (2007). *Construction Extension to A Guide to the Project Management Body of Knowledge*. Project Management Institute, Inc. USA.
- Russell A., Tran N., Staub-French S. (2014) "Searching for value: construction strategy exploration and linear planning", *Construction Management and Economics*, vol. 32, issue 6, pages 519-546.
- Sacks R., Rozenfeld O., Rosenfeld Y. (2009). Spatial and Temporal Exposure to Safety Hazards in Construction. *Journal of Construction Engineering and Management*, 135 (8), pages 726-736.
- Saurin T.A., Formoso C.T. Guimaraes L.B.M., 2004. Safety and production: an integrated planning and control model. *Construction Management and Economics* vol. 22, issue 2, pages 159-169.
- Suraji A., Duff R., Peckitt S., 2001. Development of casual model of construction accident causation. *Journal of Construction Engineering and Management*, 127 (4), 337-44
- Tam C.M., Tong T.K., Chiu C.W., Fung W.H. (2002). Non-structural fuzzy decision support system for evaluation of construction safety management system. *International Journal of Project Management*, vol. 20, pages 303-313, Pergamon.
- Yi K.J., Lee H. and Choi Y.K. (2002) "Network Creation and development for Repetitive-Unit Projects", *Journal of Construction Engineering and Management*, 128(3), 257-264
- Yi K.J., Langford D. (2006). Scheduling – Based risk estimation and safety planning for construction projects. *Journal of Construction Engineering and Management*, 132(6), 626-635.
- Veteto, C. E. (1994). The relationship between planning and safety. *Cost Engineering*, Apr. 1994, vol. 36, No. 4, pages 23-26.
- Zhang S. Teizer, J., Pradhananga N., Eastman C.M. (2015) "Workforce location tracking to model, visualize and analyze workspace requirements in building information models for construction safety planning", *Automation in Construction*, 60 (2015) 74-86.

A RESEARCH ROADMAP FOR MEGAPROJECT SUSTAINABILITY ASSESSMENT

Z. Chen and A. Agapiou

Department of Architecture, University of Strathclyde, 75 Montrose Street, Glasgow G1 1XJ, UK

Email: z.chen@strath.ac.uk

Abstract: The characteristics of sustainability within megaprojects (typically worth over \$1bn each) can make gigantic impacts on the society, the economy, and the environment at local, regional, national, and even international level depending on the nature of the project in short and longer term, and the pursuit of megaproject sustainability in development and operation is to satisfy the need for a sufficient address on dynamically interactive issues relating to social, technical, economic, ecological and political (STEEP) aspects throughout project lifecycle. Therefore it's an important but challenging task to do a reliable assessment on the overall sustainability of individual megaprojects to ensure the target is met in practice. This paper presents recent research findings about megaproject assessment on sustainability (MAS). The research has been conducted by using a new research method underpinned by TRIZ (Theory of Inventive Problem Solving) to facilitate the adoption of evidence-based learning (EBL) in further research into MAS. Findings from this TRIZ driven research include a knowledge framework, a research roadmap, and research tasks to support improved MAS in practice. It's expected that this paper can be useful for research advancement towards reliable MAS to support decision making at work stages of megaprojects.

Keywords: Megaproject, Methodology, Research Roadmap, Sustainability

1. INTRODUCTION

In the construction sector, a megaproject, which is typically worth over \$1bn, is a large scale new construction or redevelopment project that can make gigantic impacts on the society, the economy, and the environment at local, regional, national, and even international level in short and longer term. The sustainability of megaprojects, with regard to their continuous abilities at particular levels through lifecycle, is therefore crucial for not only individual but also consensus decision making in both engineering and management across interactive layers and clusters at various project stages.

According to literature review on current professional services, sustainability in megaproject practice is normally measured and reported separately on social, economic and environmental aspects on an annual basis in many corporate reports such as those provided by AECOM (2016), Bechtel (2016), Carillion (2016) and Skanska (2016) from the construction sector; and the Crown Estate (2016) and the High Speed Two (HS2) (2016) from the infrastructure sector. The fragments in sustainability reporting through the use of current approaches to assessing megaproject delivery have actually added a new risk with regard to their performance and the value for money at various project stages. The interactions of this risk with all other risks in relation to critical issues on time, cost and quality etc. can significantly upgrade the level of complexity in project management in response to the strong emphasis on sustainability in megaproject development and operation, and consequently aggravate the consistent problem of overruns on cost and time during construction, and resources usage during operation in the whole life of megaprojects.

While there are discussions worldwide on the need for implementing integrated sustainability reporting at corporate level, an integrated sustainability measurement for either existing or new megaprojects throughout lifecycle is in need to fill in the gap in the theory and practice of megaproject management in terms of developing and using new advanced techniques for integrated MAS. In response to this need, a new research project on an analytic approach to sustainability assessment in urban megaprojects has been set up recently at the University of Strathclyde, and this paper describes preliminary findings from research into a research roadmap for the technical advancement of MAS in the next decade or longer term.

This paper focuses on the description about how such a research roadmap was developed and what has been included in this research roadmap with regard to its usefulness in the integrative measurement of megaproject sustainability at the eight project stages well defined by RIBA (2013) in its latest Guide on plan of work. In order to achieve this goal, this paper aims to explore key research areas in MAS so as to draw a technical roadmap to inform further research and practice with regard to making a good contribution to the body of professional knowledge in terms of effectively tackling technical challenges such as cost and time overruns in short and longer term, effective lessons learning and knowledge use, as well as the coordinated use of building information modelling (BIM) in megaproject practice. In particular, this paper presents a new research methodology underpinned by TRIZ (Gadd, 2011), which has been used to explore areas of further research into MAS through evidence-based learning (EBL) (Cranney and McDonald, 2012). Key research findings are described here to draw a technical roadmap for further research and practice into MAS.

2. BACKGROUND

A preliminary literature review has been conducted at the early stage of this research in order to justify the aim and objectives of the research so as to establish a concrete background to further deploy research activities. The literature review has focused on two issues, including the assessment of megaproject sustainability, and the development of research roadmaps in related areas. This section describes findings from this literature review.

2.1 Megaproject sustainability assessment

The consideration, decision making, and actions on megaproject sustainability (Chen and Whitehead, 2016) within an ideal circumstance need to sufficiently address interactive STEEP issues in an effective manner throughout project lifecycle, and the complexity caused by the integrative effects of STEEP forces (Chen, 2010) has therefore continuously made it a challenging task not only in practice to achieve specified sustainability goals but also in research to measure the sustainability in a reliable way.

Academic research into MAS has been gradually developing in the past decade. For example, Chen (2007) explored the use of analytic network process (ANP) as an optioneering technique for sustainability oriented evaluation among options in a series of experimental case studies on megaprojects, including one of the largest urban regeneration projects, i.e. Liverpool ONE (Chen and Khumpaisal, 2009), three international hub airports in China (Chen, et al., 2010), and the urban light rail project Edinburgh Trams (Boateng, Chen and Ogunlana, 2015); the research described by Sarkheyli, Rafieian, and Taghvaei (2016) aims at a set of sustainability assessment criteria covering economic, environmental-physical, and sociocultural issues in

relation to processes and results in one urban redevelopment project in the Samen District of Mashhad in Iran. It has been found that both qualitative and quantitative methods have been applied in academic research into MAS, and there have been many discussions on key issues such as how to define a suitable set of assessment criteria and what the ideal evaluation techniques could be used in order to make reliable assessment.

The pursuit on sustainability in megaprojects through lifecycle has become more popular in the construction sector. One particular demonstration is the UK Government Construction Strategy 2016-20, which was recently produced by the Infrastructure and Projects Authority (IPA) (2016) seeking to improve delivery, efficiency and performance across economic and social infrastructure projects in the public, private and regulated sectors, and has set up one prioritised area on whole-life approaches to pursuing sustainability in construction. Although there has been no industry-wide tool for MAS at either work-stage level or life-cycle level, professional development on sustainability oriented assessment for construction projects has been continuously growing over the past more than 20 years. For example, the BREEAM (Building Research Establishment Environmental Assessment Method) (BRE, 2016) for the assessment of buildings and infrastructures at main work stages covering new build, operation and refurbishment, the sustainability checkpoints specified for individual work stages in RIBA (2013) Plan of Work, and the SPeAR® (Sustainable Project Appraisal Routine) (Arup, 2012), which is the tool used by sustainability consultants and sustainable buildings and sustainable infrastructure designers at Arup for sustainability appraisal to support decision-making and communicate in project development. In the meantime, there are many sustainability oriented industry awards prompting the best practice in the construction sector at global scale each year. These professional initiatives have demonstrated that it has been widely accepted by the construction industry across the world that sustainability is essential for projects no matter which stage they might be at, and it has become a necessary part of work to pursue sustainability towards specified levels in all types of projects including new construction, reconstruction, and redevelopment projects. From this point of view, there is an anticipated demand for tools for MAS in order to support better decision making by professionals at either engineering or management positions to work towards specified milestones in accordance to sustainability checkpoints specified by RIBA (2013) throughout project lifecycle. It is therefore a research task to develop work stage oriented tools for MAS.

2.2 Need for research roadmap

It is assumed for this research that nine milestones can be established in accordance to nine work stages specified with sustainability checkpoints given by RIBA (2013), and these milestones are dependable in developing a research roadmap for MAS, although there might be some alternations to be made for specific sustainability checkpoints through either modifying the existing ones or adding new ones to reflect the nature of megaprojects which are normally different from small projects. In order to put the nine milestones of megaproject sustainability onto a research roadmap, a further literature review was conducted to find answers to two essential questions, including whether there is already such a research roadmap for MAS, and what a new research roadmap for MAS should cover; and the answers to the two questions can further justify the need for and the contents of the research.

The answer to the first question was simply a null set according to the results returned from Google as at 30 June 2017 after searching by using the following two combined search terms:

- “mega project” AND sustainability AND “research roadmap”, and
- megaproject AND sustainability AND “research roadmap”.

It was therefore assumed that the described research into MAS for a research roadmap has its originality to make a contribution to the body of knowledge of megaproject sustainability, which is one important part of professional practice on megaprojects.

In order to find the answer to the second question, the literature review was conducted to look into representative research roadmaps developed in related areas. The following research roadmaps were reviewed regarding their structures and contents in specific areas:

- Arup (2013) Research Roadmap 2013,
- BSRIA (2015) BIM roadmap - a building owners' guide to implementing BIM,
- CIE (2016) Research roadmap for healthful interior lighting applications.
- DTI (2007) Roadmap for the development of intelligent monitoring of concrete structures.
- ICCPM (2011) Global Perspectives and the Strategic Agenda to 2025.

It has been found from the review into these research roadmaps that the generic contents need to be considered and covered include Research themes and areas, and Research timescale and milestones. As a result, findings on the generic format adopted in research roadmaps have provided useful information for developing a new research roadmap for MAS.

The literature review into megaproject sustainability assessment and research roadmaps has justified the need for a new research roadmap for MAS. It has been identified that the new research roadmap will need to specify research themes and areas in relation to sustainability assessment in megaprojects throughout the lifecycle, and it is also necessary for the research roadmap to clarify the timescale to achieve milestones set up for MAS.

3. METHODOLOGY

3.1 Research strategy

The strategy made for the research described in this paper focuses on the aim and objectives of research and the methodology to ensure the use of appropriate methods to derive reliable outcomes. The literature review conducted for this research has focused on the assessment of megaproject sustainability and the need for planning on the development of innovative solutions with clear identities on a research roadmap so as to improve sustainability oriented practice in megaprojects, and this has eventually led to this research into a roadmap for a comprehensive understanding and guide of further research relating to MAS, which also has numerous connections to other tasks throughout the whole life of megaprojects. The research towards such a roadmap was conducted through considering the following three objectives:

- To identify a set of research areas through a comprehensive literature review to form the theoretical framework of the body of knowledge for MAS.
- To draw a research roadmap of MAS by connecting all identified research areas in related sustainability domains into a reliable work procedure.

- To specify technical details of MAS at different work stages alongside the chosen work procedure such as RIBA Plan of Work 2013.

In order to achieve the goal of this research, a set of research methods was used. The preliminary research findings described here have been derived through the use of TRIZ integrated with EBL and system analysis and design. An extensive literature review sustained by TRIZ was used to justify research aim and objectives as well as essential research themes and areas to establish a framework of the body of knowledge for megaproject sustainability (MSBOK). A process on system analysis and design was then used to derive a research roadmap for MAS, and this include a technical framework as the procedure of MAS, and its related research tasks in short, medium and long term. It was considered when the research roadmap was developed to reflect the progress of current research and practice with regard to the best practice in related areas for megaproject sustainability.

3.2 TRIZ led EBL

TRIZ as a useful tool to establish a comprehensive understanding of problem under solving was chosen as a research method to identify themes and specific areas so as to form the research roadmap. TRIZ is the Russian acronym for "Teoriya Resheniya Izobretatelskikh Zadatch" and means the 'Theory of Inventive Problem Solving' in English. It was developed in 1946 by soviet inventor Genrich Altshuller and his colleagues (Gadd, 2011), and has been widely adopted in many industry sectors. For research in the built environment, TRIZ has been introduced in the past decade. For example, an integration of TRIZ with ANP for the multicriteria assessment of façade systems with regard to the whole life value of the design (Chen, et al., 2007), a holistic literature review approach underpinned by TRIZ to forming a technical framework of facilities management with regard to the body of knowledge and the principles (Chen, 2017). These researches have informed further research into areas where a comprehensive literature review is in need to derive the scope and directions of further research. In this regard, the TRIZ was chosen for the research described in this paper with a particular focus on essential themes and related areas of a research roadmap for MAS.

The literature review on knowledge driven assessment for the sustainable built environment indicated a lack of research into EBL to support decision making in lifecycle oriented facilities management and the necessity of new research to bridge over the gap between EBL and knowledge driven multicriteria assessment for the design (Clipson and Johnson, 1987) and management (Kovner and Rundall, 2006). In this regard, the EBL was adopted to support reliable and consistent assessment in developing the research roadmap for MAS. The integrative use of these methods in this research has shown effectiveness in identifying research themes and areas to establish a new research roadmap for MAS.

In the field of MAS, it has been of both academic interest in and professional need for specifying the MSBOK to support best practice in research and services on megaprojects. In order to derive a reliable set of MSBOK through an extensive review on literature and practice, and to verify its suitability to clustered research themes and areas at individual work stages and the whole life of megaprojects, the TRIZ was chosen to facilitate an expected inventive process to establish the framework and elements of MSBOK. For such a dedicated research, the nine-window approach, which is one practical TRIZ tool, was chosen to qualitatively identify and justify the framework of MSBOK and the clusters of research tasks.

Figure 1 illustrates the diagram of nine windows that were named and used to derive the MSBOK framework and research tasks described in this paper. In principle, the nine-window approach looks on the horizontal direction into the history, the present, and the future of the problem to be solved through a review into related information at microcosmic and macroscopic level as well as system level across the vertical direction. Based on the theory of the nine-window approach, Figure 1 presents an evolutionary process to derive the terminal goal through a middle window which collects all findings from the rest of seven windows. As illustrated in Figure 1, the window of MAS was set up as the goal of this entire nine-window analytic process and achieved through the establishment of MSBOK in the middle window to collect feedback from the following other seven windows for review on:

- Window 1: Academic research. The review focuses on research projects, publications, and knowledge exchange activities.
- Window 2: Individual professional practice. The review focuses on professional services, training, and reports.
- Window 3: Industry leadership. The review focuses on international initiatives on megaproject sustainability.
- Window 4: Collaborative professional practice. The review focuses on strategies, and interdisciplinary collaborations.
- Window 5: Supply chain network. The review focuses on guidance, product specifications, strategies, and reports at macro-system level.
- Window 6: Professional organisations. The review focuses on guidance, industry standards, statistics, and reports at macro-system level.
- Window 7: Government. The review focuses on consultations, policy, plans, regulations, statistics, and reports at macro-system level.

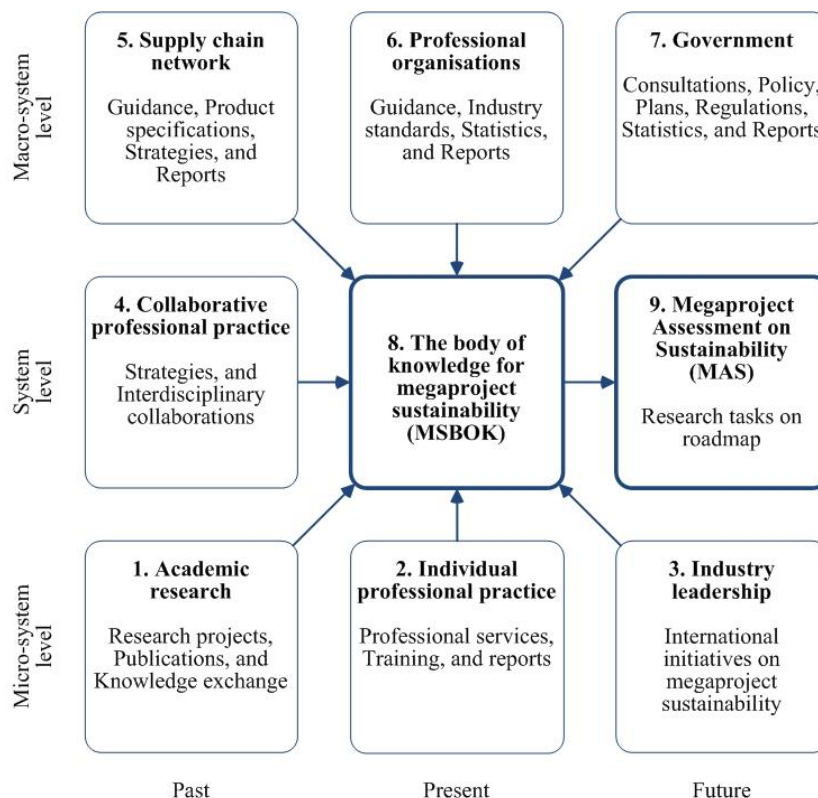

Figure 1: A TRIZ approach to identify research areas for MAS

It is expected that this dedicated review can ensure a systematic study on MSBOK from the past through present to the future at three main levels on micro-system, system and macro-system in the scope of MAS related practice and research, and derive useful solutions of the knowledge framework of MSBOK and the clusters of research tasks for MAS.

4. KNOWLEDGE FRAMEWORK

For the framework of MSBOK, this research has identified three knowledge domains across five research themes through the TRIZ driven literature review described above. The three knowledge domains include the built environment, the social environment, and the natural environment, which are recognised as critical technical domains relating to MAS. The five research themes focus on social issues, technical issues, economic issues, environmental issues, and political issues, i.e., STEEP issues, in megaproject development and management when sustainability is under consideration across the whole life. Table 1 provides a matrix to summarise the themes and associated areas of research for MAS within the framework of MSBOK, for which all identified research areas are allocated across three domains and five themes. Findings from the TRIZ driven process of literature review have identified key areas of research for MAS, and these findings were further used to design research tasks to establish the research roadmap to achieve the nine milestones indicated in response to sustainability checkpoints at nine work stages specified by RIBA (2013).

Table 1: Themes and areas of research for MAS within MSBOK framework

Themes (Chen, 2010; Boateng, Chen and Ogunlana, 2017)	Domains and areas of research (Altshuler and Luberoff, 2003; Merrow, 2010; Greiman, 2013; Priemus and Van Wee, 2013; Hart, 2015; Flyvbjerg, 2017)		
	Built environment	Social environment	Natural environment
Social issues	<i>Social needs</i>	<i>Social activities</i>	<i>Social interactions</i>
Technical issues	<i>Technical assurance</i>	<i>Technical usefulness</i>	<i>Technical interactions</i>
Economic issues	<i>Economic performance</i>	<i>Economic value</i>	<i>Economic risks</i>
Environmental issues	<i>Environmental impacts</i>	<i>Environmental concerns</i>	<i>Environmental degradation</i>
Political issues	<i>Political impacts</i>	<i>Political actions</i>	<i>Political interactions</i>

5. RESEARCH ROADMAP

The procedure of MAS is a series of connected actions to be taken at individual work stages in the whole project life to achieve the particular milestones on sustainability assessment in megaprojects. Figure 2 illustrates a generic procedure of MAS underpinned by EBL with an integration with a normal plan of work (RIBA, 2013) for megaprojects. It has been used to develop the research roadmap according to outlined processes across project work stages, and can be used as a roadmap to inform further research activities in related themes and areas summarised in Table 1 through a TRIZ driven literature review.

The procedure of MAS as illustrated in Figure 2 consists of several key elements, including a chain of normal work stages of megaprojects, a set of technical solutions yielded at individual work stages, the process of sustainability assessment, and the support of an evidence base. Although it could be deemed as an ideal plan of work for megaproject sustainability throughout the lifecycle, the implementation of such a plan of work needs sufficient support from not only

professionals working on sustainability in megaproject practice but also academics doing research into useful tools such as models, toolkits, and systems for sustainability assessment. Research focusing on key elements of the procedure of MAS is at the position to facilitate its implementation in megaproject practice, and the MAS oriented research is further described below on specific research tasks and targeted outcomes with regard to an overall support to MAS in practice in longer term.

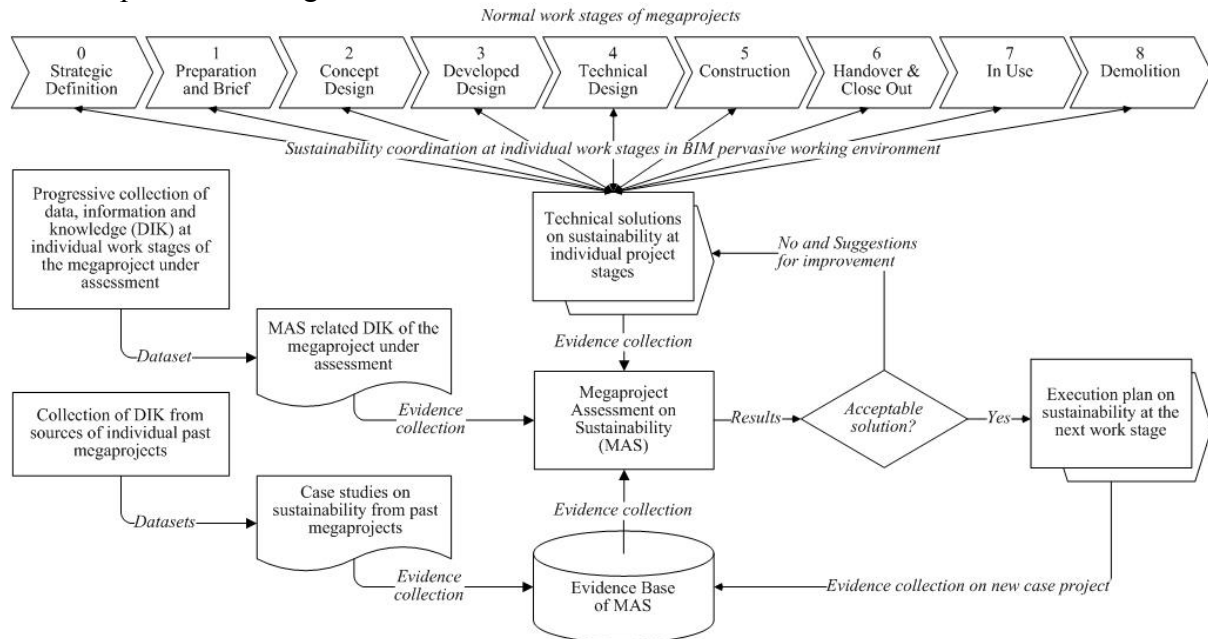

Figure 2: The procedure of MAS

6. RESEARCH TASKS

The research to support the implementation of MAS according to its procedure illustrated in Figure 2 needs to focus on several key tasks in order to achieve targeted outcomes that are useful in the practice on megaproject sustainability. A simplified description about research tasks and their outcomes for MAS is given in Table 2, which summarises, in a matrix format, the authors' perceptions on the essentials of MAS oriented research at various time scales, and was based on research themes and areas identified from TRIZ driven literature review.

Main tasks of research into MAS, as described in Table 2, has been allocated into three time periods including short term, medium term, and long term. Highlighted research work to be done at these three terms is described below:

- For short term, the research into MAS is expected to focus on developing models that can be used to conduct reliable assessment on specific targets on either specific or overall aspects relating to STEEP issues at individual work stages, and research work will need to deal with key technical issues such as assessment criteria, evaluation techniques, and useful tools, i.e., models for MAS through experimental case studies; in addition, research work at this term will also need to consider how models developed at initial time period can still be useful in the longer term with regard to their integrations with toolkits and systems for assessment.
- For medium term, the research into MAS is expected to focus on a continuous all-round improvement of models developed already, in addition to developing toolkits that are integrations of developed modules that have functions allocated in technical clusters in

relation to various work stages, and consideration on how toolkits under development can still be useful in the longer term with regard to their integrations with systems for assessment. Moreover, an evidence base will be ideally developed during this time period towards computer aided assessment, and it could be rely on a commercial software tool at an initial stage.

- For long term, the research into MAS is expected to focus on continuous all-round improvements of models and toolkits developed already, in addition to developing systems that are integrations of models as well as toolkits including the evidence base towards a powerful tool for assessment.
- For case studies, the research into MAS is expected to focus on continuous tests of tools including models, toolkits and systems developed at individual time periods, and trying to find problems and potentials for further improvement through experiments on case projects.

The general view on research tasks and outcomes over three time periods described above is to outline what research can do to support implementing the procedure of MAS. Due to the constraints on available resources for research, there will be a long way to achieve the goal of long-term research that can provide an integrated assessment tool at system level. With regard to identified need for MAS, it is therefore necessary to specify all research tasks and expected outcomes at individual work stages so that the time length of knowledge exchange from research to practice can be reduced. Based on this consideration, outcome-driven research tasks described in Table 2 are further specified into five clusters of small research tasks for immediate usages at individual work stages.

Table 2: Outcome-driven research tasks for MAS

Research outcomes	Time scale and focuses for research into MAS		
	Short term	Medium term	Long term
Models	Developing models: - Defining evaluation criteria. - Choosing individual evaluation techniques. - Developing individual models.	Improving models. - Refining evaluation criteria. - Improving individual models.	Improving models: - Developing individual evaluation techniques.
Toolkits	Consideration on toolkits: - Considering the interactions between models, and their integration to form toolkits. - Considering the functions of toolkits to be supported by models.	Developing toolkits: - Defining the functions of toolkits, and the interactions between models. - Developing individual toolkits.	Improving toolkits: - Improving the functions of toolkits, and the interactions between models. - Improving individual toolkits.
Systems	Consideration on systems: - Considering the interactions between models, and their integration in toolkits to form systems. - Considering the functions of systems.	Consideration on systems: - Considering the interactions between toolkits, and their integration to form systems. - Considering the functions of systems.	Developing systems: - Defining the functions of systems, and the interactions between toolkits. - Developing individual systems.
Case studies	Applications of models.	Applications of toolkits.	Applications of systems.

In order to specify details of research activities alongside the three time scales, research tasks specified in Table 2 have been clustered in five technical domains in accordance to five main identical project stages, including planning, design, construction, operation and demolition. Details about the five clusters of research tasks for MAS are given in Appendix.

7. DISCUSSION

The research described in this paper for a research roadmap for MAS has focused on two topics covering research themes and related areas, and specified research tasks at individual work stages within the BIM pervasive working environment throughout the whole life of megaprojects. Besides its originality in the subject field of megaproject sustainability, the research roadmap was built upon a novel procedure of MAS in reflection to megaproject practice. The purpose of developing a procedure for MAS was to ensure that the research roadmap can reflect true need for and real-world requirements on sustainability assessment in megaproject practice across all work stages. From this point of view, the research roadmap presented here has achieved the goal and has a good potential on its usefulness.

The four clusters of research tasks have been specified under four types of research outcomes to fulfil the need for practical tools and evidence to justify their usefulness. All types of research outcomes including models, toolkits, and systems for MAS and case studies using these tools were targeted with a thorough consideration on their necessary connections to all identified research themes and related areas alongside the nine milestones to achieve sustainability in megaprojects. From this point of view, the research roadmap described in this paper provides a comprehensive coverage to various demands for practice oriented deliverables through research advancement with this research roadmap.

The time scale of research for MAS has been divided into three parts, including short term for around three years, medium term for around five years, and long term for around ten years. This time oriented arrangement for research development alongside research milestones has been adopted in many research roadmaps in the past according to literature review, and has also adopted in developing the new research roadmap at professional level. In setting up this time scale, actions (research tasks) and deliverables specified in this research roadmap have therefore been allocated under a thorough consideration against workloads and achievability. From this point of view, the research roadmap developed from this research has demonstrated a practical meaning as a guide for further research into megaproject sustainability assessment.

8. CONCLUSIONS

This paper describes findings from a new research into megaproject sustainability assessment by originally providing a TRIZ driven review into related areas to form the structure of MSBOK and to develop a research roadmap for MAS in order to support further research in finding interconnected and integrative ways to quantitatively measure STEEP characteristics relating to megaprojects through individual work stages to whole-life sustainability. It is expected that the research described here could make a good contribution to the body of knowledge in megaproject management for achieving continuous research advancement on reliable sustainability assessment so as to support well-informed decision making across all work stages. In addition to its usefulness on the development of individual research tasks including a novel evidence base, the new research roadmap can also strongly support the development of a new research cluster to foster international leading research into the assessment of megaproject sustainability. Based on what have been achieved at the preliminary stage of this research, further research will be necessary to improve the research roadmap through a justification process based on peer review.

9. REFERENCES

- AECOM (2016) Sustainability Report 2015. AECOM, Los Angeles, USA.
- Altshuler, A.A., and Luberoff, D.E. (2003) *Mega-Projects: The Changing Politics of Urban Public Investment*. Brookings Institution Press, USA.
- Bechtel (2016) Sustainability Report 2015. Bechtel Corporation, San Francisco, USA.
- Arup (2012) SPeAR® Handbook 2012, External Version, Arup, London, UK.
- Arup (2013) Research Roadmap 2013, Arup, London, UK.
- Boateng, P., Chen, Z., and Ogunlana, S. (2015) An analytical network process model for risks prioritization in megaprojects. *International Journal of Project Management*, 33(8), 1795-1811.
- Boateng, P., Chen, Z., and Ogunlana, S. (2017) *Megaproject Risk Analysis and Simulation: A Dynamic Systems Approach*. Emerald Group Publishing Limited, UK.
- BRE (2016) BREEAM International New Construction 2016: Technical Manual. BRE Global Ltd., UK.
- BSRIA (2015) BIM roadmap - a building owners' guide to implementing BIM. Building Applications Guide BG 60/2015. BSRIA Limited, UK.
- Carillion (2016) Sustainability Report 2015. Wolverhampton, UK.
- Chen, Z., and Li, H. (2006) *Environmental Management in Construction: A Quantitative Approach*. ISBN: 978-0-415-37055-4 (hardback). Taylor & Francis, London and New York.
- Chen, Z. (2007) *Multicriteria Decision-Making for the Sustainable Built Environment*. ISBN: 0-7049-1209-0. University of Reading, Reading, UK.
- Chen, Z., Clements-Croome, D.J., Li, H., Shen, G.Q.P., and Chung, J.K.H. (2007) A TRIZ based ANP approach to value management in façades assessment. *The Value Manager*, 13(2), 3-8.
- Chen, Z., and Khumpaisal, S. (2009) An analytic network process for risks assessment in commercial real estate development. *Journal of Property Investment and Finance*, 27(3), 238-258.
- Chen, Z. (2010) ANP models and STEEP criteria. ARCOM Doctoral Research Workshop on Decision Making, 10/02/2010, University of Manchester, Manchester, UK. 46-56.
- Chen, Z., Li, H., Ren, H., Xu, Q., and Hong, J. (2011) A total environmental risk assessment model for international hub airports. *International Journal of Project Management*, 29(7), 856-866.
- Chen, Z., and Whitehead, C. (2016) Themed issue on Megaproject Sustainability: Call for papers, Proceedings of the ICE - Engineering Sustainability, ICE, UK.
- Chen, Z. (2017) The principles of facilities management and case studies. Proceedings of Doctoral Workshop in Building Asset Management, Association of Researchers in Construction Management (ARCOM), 21/01/2017, Glasgow, UK.
- CIE (2016) Research roadmap for healthful interior lighting applications. Technical Report 218/2016. International Commission on Illumination (CIE), Austria.
- Clipson, C.W., and Johnson, R.E. (1987) Integrated approaches to facilities planning and assessment. *Planning for Higher Education*, 15(3), 12-22.
- Cranney, J., and McDonald, F. (2012) Evidence-Based Learning. In *Encyclopedia of the Sciences of Learning*, edited by Seel, N.M., Springer, 1185-1188.
- DTI (2007) Roadmap for the development of intelligent monitoring of concrete structures. Department of Trade and Industry (DTI), London, UK.
- Flyvbjerg, B. (2017) *The Oxford Handbook of Megaproject Management*. Oxford University Press, UK.
- Greiman, V.A. (2013) *Megaproject Management: Lessons on Risk and Project Management from the Big Dig*. John Wiley & Sons, USA.
- Hart, L. (2015) *Procuring Successful Mega-Projects: How to Establish Major Government Contracts Without Ending up in Court*. Routledge, UK.
- HS2 (2016) Annual Report and Accounts 2015/16. High Speed Two (HS2) Ltd., UK.
- Kovner, A.R., and Rundall, T.G. (2006) Evidence-based management reconsidered. *Frontiers of Health Services Management*, 22(3), 3-22.
- Gadd, K. (2011) *TRIZ for engineers: enabling inventive problem solving*. John Wiley & Sons, Inc., Oxford, UK.
- ICCPM (2011) *Global Perspectives and the Strategic Agenda to 2025*, Complex Project Management Task Force Report, the International Centre for Complex Project Management (ICCPM), Deakin West, Australia.
- IPA (2016) *Government Construction Strategy 2016-20*, Infrastructure and Projects Authority (IPA), London, UK.
- Merrow, E.M. (2010) *Industrial Megaprojects: Concepts, Strategies, and Practices for Success*. John Wiley & Sons, USA.
- Priemus, H., and Van Wee, B. (2013) *International Handbook on Mega-Projects*. Edward Elgar, UK.
- RIBA (2013) *Guide to using the RIBA plan of work 2013*. RIBA Publishing Ltd., London, UK

Sarkheyli, E., Rafieian, M., and Taghvaei, A.A. (2016) Qualitative Sustainability Assessment of the Large-Scale Redevelopment Plan in Samen District of Mashhad. *International Journal of Architecture and Urban Development*, 6(2), 49-58.

Skanska (2016) Skanska Sustainability report 2015. Skanska AB, Sweden.

The Crown Estate (2016) The Crown Estate Annual Report and Accounts 2015/16. The Crown Estate, London.

Appendix: Clusters of research tasks for MAS

Project stage and sustainability milestones	Time scale and focuses for research into MAS		
	Short term	Medium term	Long term
Planning stage: MA: Assessment of strategy. MB: Assessment of preparation and brief.	<ul style="list-style-type: none"> - Defining criteria to evaluate project strategies, specifications, and feasibility, etc. - Developing evaluation models for possible usage by developers and local authorities. - Collecting evidence for MAS at planning stage. 	<ul style="list-style-type: none"> - Improving criteria and models to evaluate project strategies, specifications, and feasibility, etc. - Developing evaluation toolkits for developers and local authorities. - Collecting more evidence for developing an evidence base for MAS at planning stage. 	<ul style="list-style-type: none"> - Improving models and toolkits to evaluate project strategies, specifications, and feasibility, etc. - Developing evaluation systems for possible usage by developers and local authorities. - Developing an evidence base for MAS at planning stage.
Design stage: MC: Concept design assessment. MD: Developed design assessment. ME: Technical design assessment.	<ul style="list-style-type: none"> - Defining criteria to evaluate architectural and engineering design with specifications. - Developing evaluation models for possible usage by designers, other contractors and developers. - Collecting evidence for MAS at design stage. 	<ul style="list-style-type: none"> - Improving criteria and models to evaluate architectural and engineering design with specifications. - Developing evaluation toolkits for possible usage by designers, other contractors and developers. - Collecting more evidence for developing an evidence base for MAS at design stage. 	<ul style="list-style-type: none"> - Improving models and toolkits to evaluate architectural and engineering design with specifications. - Developing evaluation systems for possible usage by designers, other contractors and developers. - Developing an evidence base for MAS at design stage.
Construction stage: MF: Assessment of construction MG: Assessment of handover	<ul style="list-style-type: none"> - Defining criteria to evaluate construction strategies, plans, activities, and resources usages, etc. - Developing evaluation models for possible usage by construction contractors and developers. - Collecting evidence for MAS at construction stage. 	<ul style="list-style-type: none"> - Improving criteria and models to evaluate construction strategies, plans, activities, and resources usages, etc. - Developing evaluation toolkits for possible usage by construction contractors and developers. - Collecting more evidence for developing an evidence base for MAS at construction stage. 	<ul style="list-style-type: none"> - Improving models and toolkits to evaluate construction strategies, plans, activities, and resources usages, etc. - Developing evaluation systems for possible usage by construction contractors and developers. - Developing an evidence base for MAS at construction stage.
Operation stage: MH: Assessment of operation	<ul style="list-style-type: none"> - Defining criteria to evaluate operation strategies, plans, activities, and resources usages, etc. - Developing evaluation models for possible usage by developers and/or owners. - Collecting evidence for MAS at operation stage. 	<ul style="list-style-type: none"> - Improving criteria and models to evaluate operation strategies, plans, activities, and resources usages, etc. - Developing evaluation toolkits for possible usage by developers and/or owners. - Collecting more evidence for developing an evidence base for MAS at operation stage. 	<ul style="list-style-type: none"> - Improving models and toolkits to evaluate operation strategies, plans, activities, and resources usages, etc. - Developing evaluation systems for possible usage by developers and/or owners. - Developing an evidence base for MAS at operation stage.
Demolition stage: MI: Assessment of demolition	<ul style="list-style-type: none"> - Defining criteria to evaluate demolition strategies, plans, and activities, and resources usages, etc. - Developing evaluation models for possible usage by developers and demolition contractors. - Collecting evidence for MAS at demolition stage. 	<ul style="list-style-type: none"> - Improving criteria and models to evaluate demolition strategies, plans, and activities, and resources usages, etc. - Developing evaluation toolkits for possible usage by developers and demolition contractors. - Collecting more evidence for use at demolition stage. 	<ul style="list-style-type: none"> - Improving models and toolkits to evaluate demolition strategies, plans, and activities, and resources usages, etc. - Developing evaluation systems for possible usage by developers and demolition contractors. - Developing an evidence base for MAS at demolition stage.

EVIDENCE-BASED SAFETY MANAGEMENT IN BUILDING REFURBISHMENT

Z. Chen, S. Maiti and A. Agapiou

Department of Architecture, University of Strathclyde, 75 Montrose Street, Glasgow G1 1XJ, UK

Email: z.chen@strath.ac.uk

Abstract: In response to the long-term need for building asset management, this paper puts forward a new evidence-based safety analysis (ESA) approach to safety management in building refurbishment to prompt the use of evidence-based learning in practice and research in the subject field. This paper initiates a conceptual ESA framework to support the use of evidence-based method in practice-oriented research into safety management for building refurbishment. The ESA approach aims to find an innovative way to facilitate the collection of data and information from accumulated professional knowledge about accidents and failures as well as good practices and innovations, to derive useful lessons to inform improved practice in safety management in building refurbishment. Through the use of such a theoretical framework, this paper demonstrates through a case study how ESA can effectively support learning lessons from previous building refurbishment projects. It is expected that this paper can make a good contribution to the body of knowledge by providing the new ESA approach and a practice-oriented experimental case study on the use of ESA approach to safety management in building refurbishment so as to inform future practice and research at strategic and tactic level.

Keywords: Buildings, Evidence-Based Learning, Refurbishment, Safety Management

1. INTRODUCTION

Building refurbishment is an important appeal for sustainable built environment and has become one of the main proportions in the whole construction market, especially in the developed world. As described by Ala et al. (1996), it is an ideal option for modernising the existing building in terms of the consideration on a number of related issues such as the environment and it helps in retaining the old charm and significance of the existing buildings in a planned manner to adapt to new physical requirements. Under the nature of building refurbishment, it is always an important technical question as Arayici (2008) has highlighted that safety management strategies and procedures are in place to ensure the physical process to add value to the existing building. It is always a target as well as a challenge to pursue zero accident in safety management on building refurbishment, and innovative solutions to continuously improve safety management are therefore in demand.

The technical value of case or evidence based learning has been widely recognised within the learned society in the construction industry. For example, RICS (2014) as a representative from professional bodies has started to publish a series of case studies to guide strategic facilities management, and Liu, et al. (2013) as representative from academics have applied case-based reasoning technique for safety early warning in construction project. Through a preliminary literature review, it has been found that there has been a lack of research into the application of case method for safety management in building refurbishment, and a dedicated research may help to explore a formal procedure with regard to making a good contribution to the body of knowledge in this area.

This paper describes the structure of and preliminary outcomes from an ongoing research into evidence based learning for safety management in building refurbishment projects. Based on a

brief literature review on safety management in building refurbishment and evidence based practice, the aim and objectives of the described research were defined and then achieved through the use of a set of research methods including literature review, system analysis and design, and case study in order to present a new technical framework to facilitate the procedure of evidence based safety analysis (ESA) for safety management in building refurbishment. It is expected that this paper could attract interest in discussion about the research in terms of its usefulness and further research development and collaboration at this ARCOM workshop.

2. BACKGROUND

The aim and objectives of the research described in this paper were set up through a preliminary literature review in two related areas covering techniques for effective knowledge reuse for safety management in building refurbishment and evidence based learning in relation to safety management. This background review aims to justify whether it is necessary and how to conduct the research into a new ESA approach to safety management in building refurbishment.

2.1 Knowledge driven safety management

Safety management in building refurbishment needs to address a similar set of technical issues that building construction needs to deal with in terms of a series of health and safety risks associated with various issues such as Access on site; Welfare; Scaffolds; Ladders; Roof work; Powered access equipment; Traffic, vehicles and plant; Hoists; Cranes; Excavations; Manual handling; Hazardous substances; Noise; Hand-arm vibration; Electricity and other services; Confined spaces; Tools and machinery; Fires and emergencies; and Protecting the public, which have been specified by HSE (2006). For safety management in building refurbishment, there are other specific issues for professionals to deal with. For example, the health and safety risks of demolition and structural instability (Anumba, et al., 2004). Since the Construction (Design and Management) Regulations 2015 (CDM 2015) came into force on 6 April 2015, and the adoption of Building Information Management/Modelling (BIM) in the construction sector, safety management for building refurbishment is in place to incorporate new techniques to well connect stages across the whole lifecycle of building projects. In another words, safety management should be conducted from design through construction into operation in a continuous manner. While it has been always important to adopt a systematic approach (Mills, 2001) to risk management towards the target on zero fatality in construction, new practice on using knowledge through the entire or part project lifecycle has demonstrated the importance of knowledge driven safety management. For example, AstraZeneca (IOSH, 2010) in Manchester, UK has realised additional benefits through using an extended knowledge base during the design phase in a variety of projects. Therefore, it has become more and more important for safety management professionals with duties under the regulations to have new techniques that can support effective use of accumulated professional knowledge such as lessons learnt from past case projects in a BIM pervasive working environment across work stages (Hare, et al., 2006; HSE, 2015; and WBDG Secure/Safe Committee, 2017) such as RIBA (2013) Plan of Work from design through construction/refurbishment into operation.

The need for seeking informed decision making support in project management has put knowledge reuse in a demanding place in order to effectively learn lessons from past experience for better performance in new project. For safety management in building refurbishment, the

Reporting of Injuries, Diseases and Dangerous Occurrences Regulations (RIDDOR) (HSE, 2013) have made a formal procedure to accumulate lessons learnt from incidents and accidents from workplaces, and RIDDOR records have actually become a reliable source of knowledge for professionals in building refurbishment, for example, to learn lessons from past projects. It will effectively support informed decision making if both learning lessons from individual projects and identifying reasons and associated risks through statistics from reports on incidents and accidents on site can be made possible. As described by Anumba, et al. (2006), a decision support system can be applied to avoid structural collapses in building refurbishment; while Kaklauskas, et al. (2008) also described a knowledge-based decision support system for building refurbishment. It is therefore expected that the research into knowledge reuse in safety management can provide sufficient support to decision making in building refurbishment.

2.2 Evidence based learning

Evidence-based method as a practical approach to supporting effective professional learning and problem solving has increasingly gained ground in clinical practice in the past more than two decades, and has been applied with good outcomes in many subject fields. According to Sackett et al. (2000), evidence-based practice has been introduced into clinical practice for conscientious, explicit and judicious reliance on current best evidence in making decisions on the care of individual patients by involves integrating individual clinical expertise with the best external clinical evidence available drawn from systematic study, and the general procedure of evidence-based practice includes assessing the patient, asking clinical questions that arise from the case, acquiring evidence, appraising the evidence, integrating the evidence with clinical expertise and evaluating performance. For buildings, evidence-based design has been adopted in numerous projects as mentioned by (Clipson and Johnson, 1987) and it involves the consideration of facts, rational experience, building regulations and guidelines, as well as existing practice in design through a similar procedure. On the other hand, the research into and practice on evidence-based management (Kovner and Rundall, 2006) have further incorporated evidence-based learning in the management world at both strategic and tactical level. It has been found through a preliminary literature review on evidence-based learning that the formal practice adopting evidence-based method with positive outcomes have indicated a potential useful adoption in safety management in terms of many comparable similarities.

The literature review on existing research into knowledge driven safety management relating to building refurbishment and the lack of research into evidence based learning in project management has indicated a new research to bridge the gap between evidence based learning and knowledge driven safety management in building refurbishment, and the evidence-based safety analysis (ESA) approach is therefore proposed for research described in this paper. As a generic method, it is also expected that the ESA could potentially have a wider application on safety management in not only refurbishment projects but also new construction projects.

3. RESEARCH STRATEGY

The preliminary literature review summarised in the background on safety management in building refurbishment and the need for innovative tools to improve the practice, and this has led a research aiming at a new ESA approach to supporting evidence-informed safety management in building refurbishment. This research has been being conducted through considering the following objectives to achieve the aim:

- A generic theoretical framework called ESA to support the use of evidence-based method in practice-oriented research into safety management for building refurbishment.
- A procedure to implement the framework through the collection of data and information from accidents and failures as well as contemporary good practices and innovations that are relevant to safety management in building refurbishment in order to eventually derive useful lessons to form improved strategies and processes on safety management in building refurbishment projects.
- A demonstration through a series of case studies on how ESA approach can effectively support learning lessons from previous building refurbishment projects and improving safety management in new refurbishment projects.

The research methodology adopted comprises an extensive literature review to justify the aim and objectives of the study, a system analysis and design to derive the ESA framework based on current techniques for best practice in safety management, a case base to support evidence based learning in safety management in building refurbishment projects, and a series of experimental case studies through the use of ESA and the case base to demonstrate its effectiveness.

4. EVIDENCE-BASED SAFETY ANALYSIS

4.1 Technical analysis

The evidence-based safety analysis (ESA) being put forward in this paper is generally defined as a technical approach to safety management by incorporating evidence based method into the whole work process of an ongoing project, and a technical framework of ESA has been first developed in the research for building refurbishment projects. The purpose of such a technical framework is to facilitate the adoption of evidence based method in well-regulated work process for safety management in building refurbishment, and the person who will conduct ESA is assumed a CDM Coordinator or Health and Safety Manager for building refurbishment projects. According to the preliminary literature on the background of described research, technical components/processes to be integrated together to form ESA framework include the process of RIDDOR, the process of staged building refurbishment, the process of evidence based method, and the process of decision making on ESA. These technical components need to be well connected to set up an ESA integrated work programme for building refurbishment projects, and the connections across these technical components are procedures which need to be further defined to support the collection, storage, and use of evidence including data and information from past experience on similar projects undertaken by professionals inside and outside the company.

The entire work procedure for implementing an ESA framework in individual building refurbishment projects needs to comply with existing work procedures widely adopted in practice. For this preliminary research, it is ideal to adopt a formal work procedure covering the whole lifecycle of buildings because of the need for incorporating technical review on health and safety management from design through refurbishment into operation for individual refurbishment projects, and the RIBS (2013) Plan of Work is an ideal work procedure to be adapted for a ESA framework for building refurbishment.

The implementation of ESA also needs a case base that has a good amount of evidence in related areas from a rich source of past projects undertaken by both the company that will conduct an ESA in a particular building refurbishment project and other companies in local, regional, national and international scope. Despite of many other sources of evidence relating to health and safety management in building refurbishment, one particular source of evidence, for example, is the set of documentations from RIDDOR, and the structure of each case study needs to be designed with regard to the availability of data and information from RIDDOR. A specified structure of case studies is in need for collecting evidence for case studies in a unified consistent format, and this will facilitate retrieving evidence from the ESA case base.

A conceptual framework of ESA for building refurbishment projects has been developed according to this technical analysis, and presented in Figure 1. Descriptions on processes of this technical framework are given below to explain how ESA can be implemented through a formal procedure.

4.2 Technical description

An indicative technical framework of ESA has been developed at the initial stage of the described research. As illustrated in Figure 1, the framework is designed to incorporate activities to implement evidence based learning throughout a generic work procedure for which RIBA Plan of Work was chosen to adapt to the need for use in building refurbishment projects, and these activities include

- Conducting ESA in connection with other supportive activities described below, including collecting technical solutions, collecting evidence (reported case studies, and other data and information from past projects), collecting technical solutions for building refurbishment across work stages, and making judgment on technical solution assessment and execution plan for health and safety management at further work stage. The ESA process will be conducted through several technical steps including
 - Step 1: Preparing evaluation criteria and checkpoints for health and safety review and assessment at individual work stages of building refurbishment in a particular project,
 - Step 2: Acquiring related evidence on internally and externally reported injuries, diseases and dangerous occurrences and other related data and information from past practice in similar projects,
 - Step 3: Assessing the technical solution upon a particular refurbishment project at individual work stages.
- Collecting reported case studies from ESA case base based on data and information in formal documentation under regulations such as the Reporting of Injuries, Diseases and Dangerous Occurrences Regulations (RIDDOR) in UK. The case base to be developed as part of ESA prototype provides technical evidence accumulated from past projects in a wide scope covering related practice in local, regional, national, and international scale. The process to collect reported case studies is expected to be conducted from internal and external sources of an organisation where ESA is adopted, and the reason for collecting reported case studies is to ensure the reliability of evidence to be used for ESA.
- Collecting other data and information on health and safety management from projects for which internal and external reports on injuries, diseases and dangerous occurrences are eventually collected in a case base for ESA.

- Collecting technical solutions for building refurbishment at each work stage across work stages integrated within the ESA framework. These technical solutions are to be provided by a technical coordinator such as Construction (Design and Management) (CDM) Coordinator or Building Information Modelling (BIM) Coordinator (Shepherd, 2015) at each work stage for specific health and safety review according to related regulations such as the Construction (Design and Management) Regulations 2015 in UK and industry standards.
- Making judgment on the acceptance of the technical solution at each work stage.
- Making an execution plan for safety management at next work stage after a technical solution passes staged assessment.

The ESA framework presented in Figure 1 is developed to incorporate the function of evidence based learning and practice into the current work process such as the RIBA Plan of Work in building refurbishment. All ESA related activities and its technical steps are interconnected to ensure an effective implementation of evidence based learning towards a series of review on staged technical solutions and a series of execution plans for safety management at various work stages.

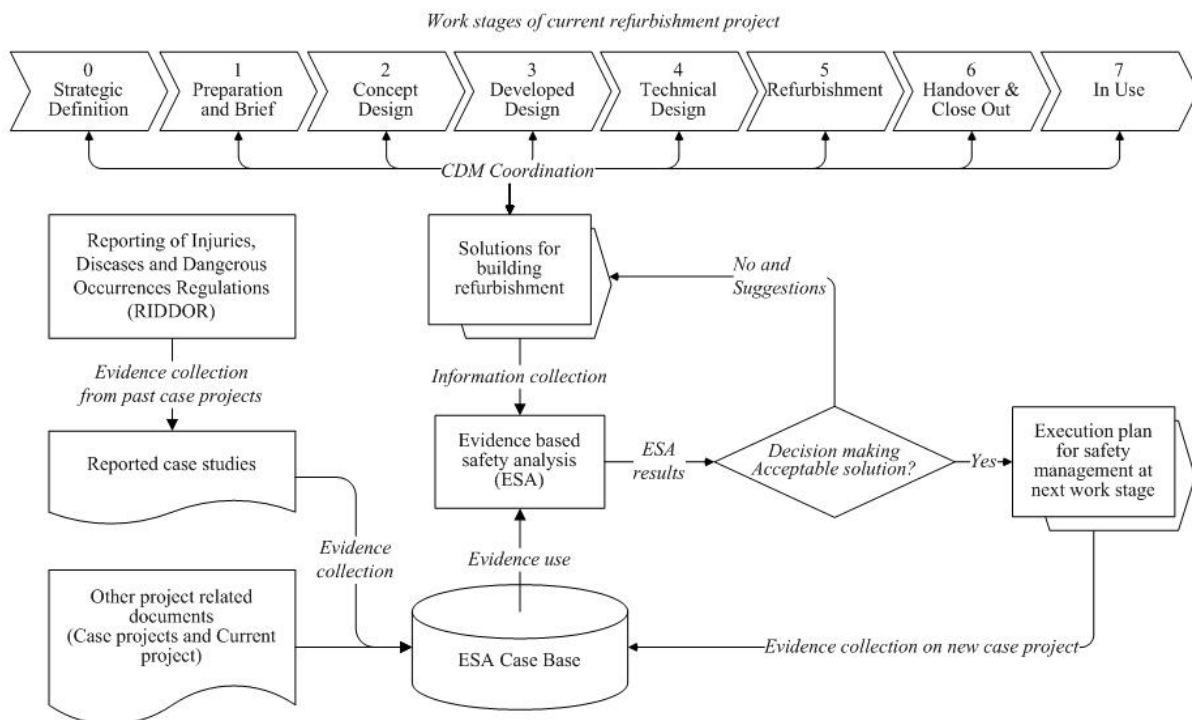

Figure 1: Figure heading below the figure

5. DISCUSSION

It is necessary to demonstrate the effectiveness of ESA in real projects after the technical framework is developed. As it is an on-going research into ESA framework and its toolkit including the ESA case base and ESA evaluation criteria and checkpoints, this paper just provides a brief discussion on the use of ESA on a scenario base in one building refurbishment project in London.

The scenario based case study is a façade replacement project for one office building alongside a busy street in central London. As shown in Photo 1, which was taken on site on 20 July 2016, a team of workers were dismantling a scaffold system in front of the building after it had been well equipped with a brand new façade system. However two risks relating to potential falling objects were spotted at that moment when the photo was taken, and these include:

- The handle of one piece of steel scaffold board on the top of scaffolding, and
- Several large pieces of reinforced polyethylene scaffold sheeting flapping on the scaffolding without control.



Photo 1: Risk of falling objects

By using ESA for this scaffold dismantling process, which was part of the entire façade replacement project, the three technical steps given in the Technical Description section above need to be conducted, and a brief discussion is given below:

- Step 1: A general set of evaluation criteria and checkpoints for safety review and assessment on a scaffold dismantling plan needs to be set up, and it needs to focus on risks in connection with falling objects and structural stability of the scaffold system. In this case study, it was obvious that the risks of falling objects were still high during

scaffold dismantling, and evidence associated with falling objects need to be further added in Step 2 in this ESA.

- Step 2: In the review and assessment of a scaffold dismantling plan prior to operation on site, lessons need to be learned and/or revisited from similar projects focusing on scaffold dismantling. As this case study is for demonstration only, evidence were therefore first collected in terms of accidents that had happened in connection to falling objects from scaffolding in building refurbishment projects in London. The following accidents were found identical from reported accidents in the City of London in recent years with regard to the risks of falling objects spotted in this project:
 - Al-Othman, 31 May 2016: A pedestrian was rushed to hospital with serious head injuries after she was hit by a piece of falling scaffolding in Rathbone Place.
 - Rucki, 5 May 2015: A pedestrian was treated for serious injuries in hospital after she was hit on the head by scaffolding which fell from a building site in Manor Park Road.
 - Blundy and Mann, 20 January 2015: Two women, both aged in their 50s, were taken to hospital with serious head injuries after being hit by falling debris in Eldon Street; while witnesses described their horror at seeing the women hit by a metal pole, which catapulted to the floor towards the opposite side of the street.
 - Morgan, 23 October 2014: A young child on his scooter escaped death “by inches” after scaffold workers dropped a 2kg metal clip onto the pavement below on a side street just off Oxford Street in front of dozens of shoppers. The terrified child froze in horror and then vomited in front of his shocked father after a metal clip used to secure the rigging fell and clipped the rear wheel of his micro-scooter. Scaffolders working on site were dismantling the scaffolding when the clip broke free.
- Step 3: A scaffold dismantling plan and its process as shown in Photo 1 is then reviewed and assessed. Based on evaluation criteria and lessons learned from partially collected evidence, conclusion from technical review and assessment on the technical solution including techniques and processes for scaffold dismantling was therefore made to amend the plan in order to reduce risks of falling objects.

This scenario based case study aims to demonstrate the procedure of ESA in technical review and assessment for reliable safety management planning on scaffold dismantling process. Although the two spotted risks of falling objects might not have led to any serious accident or injury on site, the photo taken from a site visit had revealed defects in that scaffold dismantling process, and the adoption of ESA prior to dismantling the scaffold system can ensure a safer plan of work so as to eliminate risks of accidents. In addition to ESA review and assessment, an improved scaffold dismantling plan will need to show a comprehensive consideration on directly related issues including the protection of the public and scaffolders working at height, and the entire stability of scaffold system in the dismantling process; and include a safety management procedure to cover monitoring, supervision as well as training; and these will form a safety management plan prior to scaffold dismantling.

6. CONCLUSIONS

The described research in this paper has achieved preliminary outcomes on a conceptual framework of ESA and technical descriptions on the use of ESA as an integrated technical

process for safety management in building refurbishment projects. The ESA process requires collaborations between safety management and CDM coordination throughout a chain of individual work stages to make effective and efficient review and assessment on a technical solution coming from one work stage and to make safety management plan for the next work stage if the technical solution can pass ESA review and assessment. The ESA process can therefore reinforce safety management in design through refurbishment into operation with regard to eliminating risks of accidents. Under the ESA framework presented in this paper, further research is under consideration to focus on several key technical components including an ESA case base and a set of evaluation criteria and checkpoints for ESA review and assessment.

7. REFERENCES

- Al-Othman, H. (31 May 2016) Woman rushed to hospital with serious head injuries after being hit by falling scaffolding near Tottenham Court Road, "Evening Standard", London.
- Anumba, C., Marino, B., Gottfried, A. and Egbu, C. (2004) "Health and safety in refurbishment involving demolition and structural instability". Research Report 204, Health and Safety Executive (HSE), Norwich, UK.
- Anumba, C., Egbu, C. and Kashyap, M. (2006) "Avoiding structural collapses in refurbishment: A decision support system". Research Report 463, Health and Safety Executive (HSE), Norwich, UK.
- Arayici, Y. (2008) Towards building information modelling for existing structures. "Structural Survey", 26(3), 210-222.
- Blundy, R. and Mann, S. (20 January 2015) Two women suffer serious head injuries when scaffold pole falls on them in City street, "Evening Standard", London.
- Clipson, C.W. and Johnson, R.E. (1987) Integrated approaches to facilities planning and assessment, "Planning for Higher Education", 15(3), 12-22.
- D'Ayala, D., Spence, R., Oliveira, C. and Silva, P. (1996) Vulnerability of buildings in historic town centres: a limit-state approach. In: Proceedings of the 11th World Conference on Earthquake Engineering, 23-28 June 1996, Acapulco, Mexico, paper no 864.
- Hare, B., Cameron, I., and Duff, R. (2006) Exploring the integration of health and safety with pre-construction planning, "Engineering, Construction and Architectural Management", 13(5), 438-450.
- HSE (2015) "Managing health and safety in construction - Construction (Design and Management) Regulations 2015: Guidance on Regulations". Bootle: Health and Safety Executive (HSE).
- HSE (2013) "Reporting of Injuries, Diseases and Dangerous Occurrences Regulations 2013". Bootle: Health and Safety Executive (HSE).
- HSE (2006) "Health and safety in construction", 3rd edition. Bootle: Health and Safety Executive (HSE).
- IOSH (2010) "Global best practices in contractor safety: IOSH/ASSE good practice guidelines". Wigston: Institution of Occupational Safety and Health (IOSH).
- Kaklauskas, A., Zavadskas, E.K. and Galiniene, B. (2008) A building's refurbishment knowledge-based decision support system, "International Journal of Environment and Pollution", 35(2-4), 237-249.
- Kovner, A.R. and Rundall, T.G. (2006) Evidence-based management reconsidered, "Frontiers of Health Services Management", 22(3), 3-22.
- Liu, Y., Yi, T.H. and Xu, Z.J. (2013) Safety Early Warning Research for Highway Construction Based on Case-Based Reasoning and Variable Fuzzy Sets. "The Scientific World Journal", Article ID 178954.
- Mills, A. (2001) A systematic approach to risk management for construction, "Structural Survey", 19(5), 245-252.
- Morgan, B. (23 October 2014) Boy on scooter cheats death by inches when 2kg metal clip falls on to Oxford Street as workers dismantled scaffolding, "Evening Standard", London.
- RIBA (2013) "Guide to using the RIBA plan of work 2013". London: RIBA Publishing Ltd.
- RICS (2014) "Strategic facilities management: case studies". London: Royal Institution of Chartered Surveyors (RICS).
- Rucki, A. (5 May 2015) Pedestrian seriously injured after being hit on head by piece of falling scaffolding from north-west London building site, "Evening Standard", London.
- Sackett, D.L., Straus, S.E., Richardson, W.S., Rosenberg, W. and Haynes, R.B. (2000) "Evidence-Based Medicine: How to Practice and Teach EBM", London: Churchill Livingstone.
- Shepherd, D. (2015) "BIM Management Handbook". London: RIBA Publishing.

WBDG Secure/Safe Committee (2017) "Occupant Safety and Health", Whole Building Design Guide (WBDG), Washington: National Institute of Building Sciences.

REVIEW OF CONSTRUCTION PRACTICES IN THE LIGHT OF THE HONG KONG FIRST-EVER COMPETITION ORDINANCE

S. O. Cheung

Professor, Construction Dispute Resolution Research Unit, Department of Architecture and Civil Engineering,
City University of Hong Kong

Email: Saion.Cheung@cityu.edu.hk

Abstract: Effective competition is believed to offer a framework for efficient operations. For this reason, competition legislations are used quite widely to ensure competition that would benefit consumers. After almost forty years of consultation and deliberation, Hong Kong enacted her first-ever Competition Ordinance (HKCO hereafter) in 2012. The HKCO came into full effect on 14th December 2015 after the Hong Kong Competition Commission (HKCC hereafter) published implementation guidelines early the same year. After one year of operation, the HKCC reported that about 1900 complaints/enquiries were received in 2016. Among these, 50% are related to the First Conduct Rule (FCR hereafter) and another 20% are about Second Conduct Rule (SCR hereafter). The FCR and SCR are therefore considered to have the most impact on anti-competition activities. The FCR seeks to curb agreements among undertakings that would prevent, restrict or distort competition in Hong Kong. SCR enables governmental administrative interventions should market players having substantial market power abuse their power and carry out anti-competition activities. The paper reports a review of three types of agreements in construction that may infringe the HKCO. These include bidding arrangement, daily wage and joint ventures. The findings suggest that there is no immediate danger of infringements. Moreover, it is recommended that exemption under the HKCO should be applied by the relevant stakeholder groups to ensure these agreements are not challenged.

Keywords: Anti-Competition Agreements, Bidding, Daily Wages, Joint Venture

1. INTRODUCTION

Competition requires market players to improve efficiency to remain competitive. In this regard, ultimate users and consumers will benefit from the resulting savings or extras. More significantly, innovations derived from competition have been proved to be the most valuable outcomes of competition. In many developed economies, competition legislations have been used to regulate markets by setting up rules to guard against or penalize anti-competition activities. Hong Kong has been well known as being the free-most economy in the world. The enactment of the HKCO is the formal establishment of a competitive regime in Hong Kong. Agreement in bidding arrangement, collective agreement on tradesmen daily wages and joint venture agreements are reviewed in the light of the conduct rules of the HKCO. These agreements are selected for review because, prima facie, they are vulnerable. and they have also been commonly used in the construction industry.

2. THE HONG KONG COMPETITION ORDINANCE (CAP 619)

The Hong Kong Competition Ordinance (HKCO) was enacted in 2012 (Zhao et al. 2014) and came into full force at the end of 2015. The HKCO is a cross-sector one and prohibits three categories of conduct through the following measures: i) a general prohibition against anti-competition agreements, concerted practices and decisions of associations (The First Conduct Rule); ii) a prohibition against the abuse of substantial market power in a market (The Second

Conduct Rule); and iii) a prohibition against mergers that have the effect of substantially lessening competition in Hong Kong (however, the Merger Rule is limited to mergers involving holders of carrier licenses under the Telecommunications Ordinance). The HKCC has the following functions:

- To investigate conduct that may contravene the competition rules of the HKCO and enforce the provisions of the HKCO;
- To promote public understanding of the value of competition and how the HKCO promotes competition;
- To promote the adoption by undertakings conducting business in Hong Kong of appropriate internal controls and risk management systems and to ensure their compliance with the HKCO;
- To advise the Government on competition matters in Hong Kong and outside Hong Kong;
- To conduct market studies into matters affecting competition in markets in Hong Kong; and
- To promote research into, and the development of skills in relation to, the legal, economic and policy aspects of competition law in Hong Kong.

2.1 The First Conduct Rule (S6, HKCO)

‘Section 6: prohibition of anti-competitive agreements, concerted practices and decisions

- (1) An undertaking must not-
 - (a) make or give effect to an agreement;
 - (b) engage in a concerted practice; or
 - (c) as a member of an association of undertakings, make or give effect to a decision of the association,
If the object or effect of the agreement, concerted practice or decision is to prevent, restrict or distort competition in Hong Kong.
- (2) Unless the context otherwise requires, a provision of this Ordinance which is expressed to apply to, or in relation to, an agreement is to be read as applying equally to, or in relation to, a concerted practice and a decision by an association of undertakings (but not any necessary modifications).
- (3) The prohibition imposed by subsection (1) is referred to in this Ordinance as the “first conduct rule”.

The FCR applies to both horizontal and vertical arrangements (whether they are agreements or concerted practices between undertakings) which have the object or effect of preventing, restricting or distorting competition, unless there is a compelling efficiency justification.

2.2 The Second Conduct Rule (S21, HKCO)

‘Section 21 Abuse of Market Power

- (1) An undertaking that has a substantial degree of market power in a market must not abuse that power by engaging in conduct that has as its object or effect the prevention, restriction or distortion of competition in Hong Kong.

- (2) For the purpose of subsection (1), conduct may, in particular, constitute such an abuse if it involves-
 - (a) predatory behavior towards competitors; or
 - (b) limiting production, markets or technical development to the prejudice of consumers.
- (3) Without limiting the matters that may be taken into account in determining whether an undertaking has a substantial degree of market power in a market, the following matters may be taken into consideration in any such determination-
 - (a) the market share of the undertaking;
 - (b) the undertaking's power to make pricing and other decisions;
 - (c) any barriers to entry to competitors into the relevant market; and
 - (d) any other relevant matters specified in the guidelines issued under section 35 for the purposes of this paragraph.
- (4) The prohibition imposed by subsection (1) is referred to in this Ordinance as the "Second Conduct Rule".⁹

The SCR applies when an undertaking with a substantial degree of market power, abuses its market power by engaging in conduct which has the object or effect of preventing, restricting, or distorting competition in Hong Kong. The guideline of the SCR confirms that the market will be considered by reference to factors such as product and geographic market boundaries.

3. VULNERABLE AGREEMENTS COMMONLY USED IN CONSTRUCTION

Upon a review of the practices of the construction industry, three types of agreement are considered susceptible under the HKCO. These are agreement in bidding arrangement, tradesmen daily wages and joint venture. These are, prima facie, vulnerable in the light of the description of anti-competition activities under the HKCO.

3.1 Agreement in bidding arrangement

Bid rigging is considered an anti-competitive behaviour (Consumer Council 2003). The Consumer Council (2003) of Hong Kong suggested four possible forms of bid rigging: i) Cover Bidding, which occurs when the winning bid is ensured by higher bids submitted by other bidders through agreement among themselves; ii) Bid Suppression involves one or more of a group of bidders agreeing not to bid or to withdraw their bid in order to create a false sense of competition; iii) Bid Rotation happens when the conspirators systematically or randomly allocate a winning bid among themselves; and iv) Market Allocation, when a group of bidders agrees not to compete for certain markets either by customer or geographically (Cheung, 2016a).

Bid rigging has been an issue in construction contracting for many years (Ming Pao, 2014). Most practices of bid rigging happen in very subtle ways. The most controversial agreement in bidding is the agreement not to compete. The issue was deliberated in *HKSAR v Chan Wai Yip & Ors* [2011] 1 HKC 580¹. The Hong Kong Government alleged that from June to July 2004, the defendants had conspired to defraud the Food and Environmental Hygiene Department ("FEHD"). The defendants were tenants of the old Tai Po Market that needed to be re-developed. The FEHD had given the defendants the opportunity to bid for 40 stalls in the

¹ Case: *HKSAR v Chan Wai Yip & Ors* [2011] 1 HKC 580

newly built Tai Po Hui Market, with reserve prices fixed at 75% of the market rent. The various defendants had among themselves agreed not to compete in the auction and had secretly drawn lots for stalls that they would bid for at the respective reserve price at the auction. The defendants were charged with conspiracy to defraud and were all convicted. On appeal to the Court of Appeal, the Hong Kong Government relied on the pre-allotment and the agreement not to compete as the constituent elements of the conspiracy to defraud. The case reached the Court of Final Appeal.

“There were three questions for the Court of Final Appeal:

- i) Was the formulation in *Mo Yuk Ping v HKSAR* (2007) 10 HKCFAR 386² applicable to all forms of alleged conspiracy to defraud and should it also be applied to a secret agreement not to compete at an auction as in any other cases or does some aggravating feature as required in *Norris v Government of the USA* [2008] 1 AC 920³ need to be present before such an agreement is indictable?"
- ii) Does the conduct of an auction in a commercial context by its very nature necessarily imply that only competitive and genuine bids are acceptable, such as to prohibit any price fixing conduct in respect of it, and thereby render such conduct dishonest and prima facie indictable?
- iii) Does the incorporation of an express condition in the auction rules to the effect that only competitive and genuine bids are acceptable, prohibit any price fixing conduct in respect of it, and thereby render such conduct dishonest and prima facie indictable?

The Court of Final Appeal of Hong Kong held that no conspiracy to defraud was found. Thus, in common law, agreement not to compete is not illegal per se. Now with the HKCO, would the same bidding arrangement infringe the FCR?

In *HKSAR v Chan Wai Yip & ORS*, the purpose of the agreement was made so that the defendants bid for the respective stalls that had been allotted to each of them before the auction. This served to ensure the bidders would not compete against each other during the restricted auction. The nature of the agreement therefore was to avoid competition. When it was applied in the restricted auction with the defendants being the only bidders, the effect was virtually no competition for each of the lots being auctioned. The agreement also had the indirect effect of fixing the price of the stalls. When there was no competition for each stall, the price would be kept at the reserved level that was known to the defendants. Even if the defendants did not know the reserved price, the agreement would still have led to the sale of the lots at the same price. As a result, it can be claimed that the reserved price is fixed by the bidders collectively.

An agreement not to compete is anti-competition by the resulting effect on price. However, in common law, there is a long line of English authorities supporting the position that ‘knock-out’ agreements, whereby potential buyers agree not to bid at an auction are not illegal per se. Agreements not to compete are anti-competition, the competition-lessening effect of such agreements are likely to infringe the FCR of the HKCO (Cheung, 2016a).

3.2 Agreement of Tradesmen Daily Wages (ATDW)

² Case: *HKSAR v Chan Wai Yip & Ors* [2011] 1 HKC 580

³ Case: *Norris v Government of the USA* [2008] 1 AC 920

Under ATDW, the associations of the key trades would review annually the daily wages for their members. The associations would come up with suggested daily wages for their respective trades. Contractors and subcontracts will contract with these tradesmen with reference to the suggested daily wages (Cheung, 2016b).

First, are trade associations' undertakings as stated in Section 6(1) at the HKCO? The term undertaking is defined in section 2(1) of HKCO as any entity which is engaged in an economic activity. Referring to item 2.2 of the guideline on the First Conduct Rule (HKCC 2015), examples of undertaking include individual companies, groups of companies, partnerships, individuals operating as sole traders or subcontractors, co-operatives, societies, business chambers, trade associations and non-profit organizations. Furthermore, Section 2(1) (a) of the HKCO provides that an anti-competitive conduct is defined as any conduct that consists of fixing, maintaining, increasing or controlling the price for the supply of goods or services.

In addition, a similar situation can be found in the fee scales offered by many professional bodies such as the architects, engineers and surveyors before the enforcement of the HKCO. Although the fee scales have not been followed strictly for quite a while, in late 2015 nearly all professional bodies in Hong Kong took out fee scale from their web sites as part of the HKCO compliance measures.

Item 6.81 of the Guideline for FCR states that "Recommended or maximum resale price arrangements, when they are combined with measures that make them work in reality as fixed or minimum prices, will be assessed in the same manner as Resale Price Maintenance (RPM)." Tradesman associations are undertakings and ATDW can be interpreted as fixing the daily wages of tradesmen if the agreed wages serve as the minimum and will contravene the first conduct rule of the HKCO. However, in the event that ATDW is considered as just providing a reference, there would be no price-fixing effect and hence not anti-competition.

With due regard that certain anti-competition conducts may also bring benefits to consumers and a detriment if these conducts are prohibited, the HKCO allows certain agreements to be eligible for exclusions and exemptions. The HKCO allows exemptions from the conduct rules if the agreement enhances overall economic efficiency (S1 of Schedule 1 of the HKCO).

Under Schedule 1 of the General Exclusions from Conduct Rules, agreements enhancing overall economic efficiency can enjoy general exclusion from the conduct rules. Thus, the first conduct rule does not apply to any agreement that –

- (a) Contributes to –
 - (i) Improving production or distribution; or
 - (ii) Protecting technical or economic progress,
While allowing consumers a fair share of the resulting benefits;
- (b) Does not impose on the undertakings concerned restrictions that are not indispensable to the attainment of the objectives stated in paragraph (a); and
- (c) Does not afford the undertakings concerned the possibility of eliminating competition in respect of a substantial part of the goods or services in question.

Item 2.5 of the Guideline further adds that the efficiency exclusion applies when four separate conditions are met.

First condition: The agreement contributes to improving production or distribution or promoting technical or economic progress.

Second condition: Consumers receive a fair share of the efficiencies.

Third condition: The agreement does not impose on the undertakings concerned restrictions that are not indispensable to the attainment of the relevant efficiencies.

Fourth condition: The agreement does not afford the undertakings concerned the possibility of eliminating competition in respect of a substantial part of the goods or services in question.

ATDW only sets a reference or benchmark, the employers of these tradesmen are free to negotiate with due regard to the market conditions. It is therefore suggested that ATDW will not lessen competition. Even if there is potential of doing so, ATDW should qualify as agreement that enhances overall economic efficiency and is eligible for exemption from the FCR as discussed (Cheung, 2016b).

3.3 Joint venture agreements

Joint venture can be used to describe situations where more than one company unite their resources to achieve a common goal or shared interest (Pitofsky, 1969). Joint-ventures are used extensively in complex construction projects. Kitch (1985) suggested that, compared with a merger, a joint venture involves fewer restraints on competition but offers more efficiency gains than a cartel or a price fix. Another difference identified by Mead (1967) and Brodley (1982) is that a joint venture creates a business entity separate from its parents. Thus, there is in theory no reduction in the number of participants in the market after the formation of a joint venture. Werden (1998) further distinguished a joint venture from a mere cartel by suggesting that true joint ventures should achieve efficiency-enhancing economic integration. Notwithstanding the difficulty in defining joint ventures, is the “lack of sharp definition that would distinguish joint ventures from other interfirm contractual agreements” (Brodley, 1982).

Anti-competition hazards of horizontal joint ventures include potency of collusions and increasing entry barriers (Pfeffer and Nowak, 1976, Pitofsky, 1969). There have been great concerns over whether a joint venture becomes a de facto merger (Pfeffer and Nowak, 1976, Pate, 1969). Competition can be lessened or eliminated by horizontal joint ventures in the following contents:

- a) Actual competition between parents (Bernstein, 1965, Pfeffer and Nowak, 1976).
- b) Actual or potential competition between either one of the parent firms and the joint venture enterprise (Bernstein, 1965, Pitofsky, 1969, Brodley, 1982, Pfeffer and Nowak, 1976).

Drew and Skitmore (1997) argued that the competitiveness of every bidder depends on both the size and type of the projects. In a construction contracting market, it is possible that the variation of contract size can change the competitiveness of firms of varying sizes and hence alter the overall competition level by the market. Shen and Cheung (2016) investigated the consequences of joint bidding on concentration of a mega project market. The Hong Kong Ten-mega project market was used in the study. Concentration measures are used indicate the level of competition of the market.

One of the most commonly used concentration measures adopted by the U.S. Bureau of Census and the U.S. Government Accountability Office is the four-firm concentration ratio (CR₄). Another measure that has been widely used is Herfindahl-Hirschman Index (“HHI”). Both the

U.S. Department of Justice (DOJ) and Federal Trade Commission (FTC) use HHI as an indicator of market concentration.

Four-firm concentration Ratio (CR_4) is the sum of the market shares accounted for by the top four firms in the market (Perloff et al., 2007) and can be expressed as below:

$$CR_4 = S_1 + S_2 + S_3 + S_4 \quad (1)$$

This index approaches zero where there is infinite number of firms in the market and equals one where four firms' market shares have made up the entire industry (Bikker and Haaf, 2002).

Herfindahl-Hirschman Index ("HHI") is the sum of the squared market shares of all the firms in the market (Perloff et al., 2007).

$$HHI = \sum_{i=1}^n S_i^2 \quad (2)$$

Where S_i is the market share of the i^{th} firm. HHI value ranges from 0 to 1, when HHI equals 1, the market structure will be considered a monopoly (Hirschman, 1964).

According to the standards used by the Department of Justice (DOJ) and the Government Accountability Office (GAO) in the United States, the market is considered as un-concentrated when HHI is below 0.15 or CR_4 is below 40%. When HHI is between 0.15 and 0.25 or CR_4 is between 40% and 60%, the market is considered loosely concentrated. When HHI is higher than 0.25 or CR_4 is higher than 60%, the market is considered highly concentrated.

The contract value each firm obtained in the Hong Kong Ten-mega project market from 2010 to 2015 are used to represent their market shares. At the time of study, six of the Ten-mega projects that had commenced were analysed in this study. The contract values obtained by the firms may not be final, as all the projects are still in progress and many works have not yet been awarded. In total, there are 81 contractors involved, and 35 contracts were awarded to joint ventures. There was only one joint venture that had submitted tender for three different projects while each of the remaining joint venture entities only obtained one contract. In addition, one third of the joint venture parent firms formed more than one joint venture with different partners.

For this study, joint venture entities are counted as contractors independent of their parents. There are in total 81 firms with the largest one having 14.76% market share.

Prior studies suggest that joint venture can be an effective device to facilitate fringe firms to enter the market while greater convenience is provided to fully capable firms to reduce competition (Mead, 1967, Kitch, 1985, Pfeffer and Nowak, 1976). In this study, the effects of joint ventures are analysed separately for inactive firms and for active firms.

There are altogether 7 contractors which obtained 6 or more contracts and 9 contractors which obtained at least 5 contracts. Among the total 81 firms, they represent the first ten percent of the most active players in the market. Meanwhile, there are in total 50 firms only getting one contract, representing the most inactive players in the market. Table 1 gives the details of the market share distributions among 7 contractor market.

Table 2 summarises the CRs and HHIs obtained for the markets of 7 most active contractors and 9 most active contractors respectively. Comparing the results of the 7-firm and 9-firm markets (Table 2 refers), there is notable difference in the concentration level.

For the market of 50 most inactive contractors, 24 of them get awarded with contracts in the form of joint ventures, but only six of the joint ventures are formed exclusively by the 50 inactive contractors. The remaining 18 joint ventures are formed by at least one sizable company and one inactive firm. Table 3 shows CR₄ and HHI for this market. This market appears to be less concentrated when contract package is split into smaller parts for small firms.

Table 1: Test I for 7 most active contractors

Contractor	Contract Value	%	% ²
Firm A	12,534,750,236	14.79%	218.6904335
Firm B	2,053,440,949	2.42%	5.868983012
Firm C	9,428,533,146	11.12%	123.733324
Firm D	4,249,549,964	5.01%	25.13531287
Firm E	13,500,369,140	15.93%	253.6820292
Firm F	4,904,890,611	5.79%	33.4855216
Firm G	2,887,054,080	3.41%	11.60134265
Firm A – Firm E Joint Venture	5,869,282,300	6.92%	47.94776998
Firm A – Firm B Joint Venture	8,400,000,000	9.91%	98.21028877
Firm A – Firm C Joint Venture	11,793,608,604	13.91%	193.5939751
Firm C – Firm D Joint Venture	3,368,442,219	3.97%	15.79270852
Firm D – Firm B Joint Venture	1,422,000,000	1.68%	2.814476383
Firm F – Firm E Joint Venture	4,350,000,000	5.13%	26.33764441
SUM	<u>84,761,921,249</u>		
CR ₄	55.75%		
HHI	1056.89381		

Table 2: Concentration Level of active contractors

Market	7-firm	9-firm
CR ₄	55.75%	55.70%
HHI	1056.89381	1116.355113

Table 3: Concentration Level of the 50 inactive contractors

Measures	Results
CR ₄	42.45%
HHI	740.6297

The findings suggest that the use of joint ventures in the Hong Kong Ten-mega projects has little impact on the concentration level for active large firms. However, for inactive fringe firms, joint ventures are found to have the effect of lowering competition (Shen and Cheung, 2016).

Joint venture in construction is more like a temporary agent synergizing the resources from several participating JV partners rather than creating a new entity. Projects of high value and sophisticated technical requirements are usually undertaken by joint ventures formed by two or more large contractors active in the market. Sizing down these contracts into smaller contract packages may not have significant impact on the market competitiveness. Moreover, the joint venture activities by the inactive contractors raise the market concentration because the overall number of market participants is reduced (Shen and Cheung, 2016).

4. SUMMARY AND CONCLUDING REMARKS

Hong Kong enacted her first-ever Competition Ordinance (HKCO) which came into full effect on 14th December 2015. Among the rules under the HKCO, the First Conduct Rule (FCR) and Second Conduct Rule (SCR) are considered as having greater impacts on the construction industry. FCR seeks to curb agreements among undertakings that would prevent, restrict or distort competition in Hong Kong. SCR enables governmental administrative interventions should a market player having substantial market power abuse their power and carry out activities that would prevent, restrict or distort competition in Hong Kong. For the construction industry, the immediate impact can be noted from the abolishment of professional fee scales that are considered as a type of agreement that will prevent, restrict or distort competition for construction professional services in Hong Kong. Likewise, three types of agreements that are considered vulnerable are reviewed in the light of the HKCO conduct rules. These are agreement in bidding arrangement, tradesmen daily wage and forming joint venture. It is found that agreement not to compete in bidding is vulnerable under the FCR although it is not illegal in common law. Daily wage agreements of construction tradesmen are benchmarks only. These wages will not be taken as setting minimum wages for the respective trades. As such, there should be no anti-competition effect. Furthermore, because of the contribution to economic efficiency, exemption from the FCR is considered justified. Joint venture agreements are not per se anti-competition. Moreover, these may present a competition issue should the market be very discrete and only has only a few firms participating. Forming joint ventures will reduce the overall number of participants.

5. ACKNOWLEDGEMENTS

The work described in this paper was fully supported by a HKSAR General Research Fund (project number 11201914).

6. REFERENCES

- Bernstein, L. 1965. Joint Ventures in the Light of Recent Antitrust Developments: Anti-Competitive Joint Ventures. *Antitrust Bull.*, 10, 25.
- Bikker, J. A. & Haaf, K. 2002. Measures of competition and concentration in the banking industry: a review of the literature. *Economic & Financial Modelling*, 9, 53-98.
- Brodley, J. F. 1982. Joint ventures and antitrust policy. *Harvard Law Review*, 1521-1590.
- Cheung, S.O. (2016a), "Are Agreements not to Compete Anti-competition?", *The ASCE Journal of Legal Affairs and Dispute Resolution in Engineering Construction*, Vol. 8(2), May 2016 (doi: 10.1061/(ASCE)LA.1943-4170.0000181)
- Cheung, S. O. (2016b) "Would Tradesman Collective Wage Agreement be exempted from the Hong Kong Competition Ordinance?", *The Third Australasia and South-East Asia Structural Engineering and Construction Conference*, Kuching, Sarawak, Malaysia, Oct31-Nov4, 2016

- Competition Commission (2014) "Draft Guideline on The First Conduct Rule", HKSAR.
- Competition Commission (2014) "Draft Guideline on The Second Conduct Rule", HKSAR.
- Consumer Council (2003), "Recommended Procedures For Tendering Parties To Identify And Prevent "Bid-Rigging", Hong Kong Consumer Council publication on Competition Studies.
- Drew, D. & Skitmore, M. 1997. The effect of contract type and size on competitiveness in bidding. *Construction Management & Economics*, 15, 469-489.
- HKSAR, CAP 619, Hong Kong Competition Ordinance, CAP 610, 2012.
- Hong Kong Competition Commission, Guideline on The First Conduct Rule, 2015.
- Hong Kong Competition Commission, Guidleine on Applications for a Decision under Sections 9 and 24 (Exclusions and Exemptions) and under Section 15 Block Exemption Orders, 2015.
- KITCH, E. W. 1985. Antitrust Economics of Joint Ventures, *The Antitrust LJ*, 54, 957.
- Ming Pao. (2014, February 12). Dim side of Operation Building Bright. Retrieved from Ming Pao English: <http://english.mingpao.com/cfm/database3b.cfm?File=20140212/critic/ema1.txt>
- MEAD, W. J. 1967. Competitive Significance of Joint Ventures, *The Antitrust Bull.*, 12, 819.
- PATE, J. L. 1969. Joint venture activity, 1960-1968. *Economic Review*, 16-23.
- PERLOFF, J. M., KARP, L. S. & GOLAN, A. 2007. *Estimating market power and strategies*, Cambridge University Press.
- PFEFFER, J. & NOWAK, P. 1976. Patterns of joint venture activity: implications for antitrust policy. *Antitrust Bull.*, 21, 315.
- PITOFSKY, R. 1969. Joint Ventures under the Antitrust Laws: Some Reflections on the Significance of "Penn-Olin". *Harvard Law Review*, 1007-1063.
- Shen Lu and Cheung S.O. (2016) "Would Joint Ventures affect Competition?", Project Management Symposium, University of Maryland, 12-14 May, 2016
- WERDEN, G. J. 1998. Antitrust analysis of joint ventures: An overview. *Antitrust Law Journal*, 701-735.
- Zhao X. J., Cheung S.O. and Guo Y.S. (2014) "The Impact of the Hong Kong first ever Competition Law on construction contracting", *The ASCE Journal of Legal Affairs and Dispute Resolution in Engineering and Construction*. Vol. 6(2): May 2014

REALISING “NEAR ZERO CARBON” BUILDING REGULATION – COMPARING SUSTAINABLE HOUSING DEVELOPMENTS IN DENMARK AND SWEDEN

C. Koch¹ and S.Gottlieb²

¹ *Architecture and Civil Engineering, Chalmers University of technology, 42196, Gothenburg Sweden*

² *SBI, Aalborg University, 2450, Copenhagen SV, Denmark*

Email: kochch@chalmers.se

Abstract: Over the last ten years standards for sustainable building have become increasingly tight. Central in this development is the EU, and subsequently national, regulation. From 2002 these have defined both prescriptive energy criteria and more performative regulation of “near zero carbon” sustainability to enable local and national innovation to flourish. The shifts in regulation regime are analysed, asking: Have the policy mixes and regime shifts given the intended impact on a transition toward zero carbon? Theoretically, institutional and political science concepts of public regulation are used, providing a review of regulation forms and their relation to innovation. Other paradigms of sustainable housing are viewed as competing institutions, using “anticipative institutionalisation” for the process where rules are installed before they are law. A comparative study between Sweden and Denmark of the responses to the call for near zero carbon regulation is done. The investigation shows that the zero carbon regulation exhibits differences between the countries both in their substantive elements and in the soft law initiatives. The anticipative institutionalisation before 2020 is compared to that of 2010 and 2015. Even if the results are not impressive, performative regulation can be said to better respond to the continual process of improving sustainability.

Keywords: Institutionalism, Near Zero Carbon, Public Regulation, Sustainability

1. INTRODUCTION

Few that have followed the sustainable building development, will deny the active role of public policy and regulation and its impact. Yet few have approached how the complexity of developing buildings sustainably and the complexities of policies interact. It has been suggested that the ‘policy mix’, the combination of obligatory norms, voluntary certification, subsidies etc., is an important explanatory element. But also the coupling between regulators and the regulated, and the political volition of policy makers appear important, or seen as a whole, the policy regime (Antonsen et al., 2017). Thinking of sustainable building development like this implies adopting a series of political science concepts (Flanagan et al., 2011; Edler and Georghiou, 2007; Kelly and Palumbo, 1992; Teubner, 1983). A central philosophy of policy and regulation is that it should ideally anticipate instrumental societal development or at least be on a par with societal development (Stillgoe et al., 2013). In other words regulation is not instrumental if it stiffens and stabilizes. This is at issue with some industry spokesmen who appear to believe that stability in law and regulation is best for industrial development. Here the contention is that a dynamic policy and regulation lead to important innovations and that sustainability regulation therefore has more to offer than mere side effect of industrial business development of cleantech.

The development of sustainable building also very clearly feature a mixture of policies regarding energy, energy efficiency, climate change mitigation, and more specifically sustainable built environment (economic, environmental and social sustainability). The coordination and the respective strength of these policies are central to consider in two ways.

First, the coordination of instruments is central in creating legitimacy and institutional commitment to a given innovation regarding both process and outcome. Stilgoe et al. (2013: 1574-1577) thus argue that responsible innovation requires integration and embedding in governance of various instruments to avoid piecemeal processes that are based in particular values, e.g. EU values alone. Creating commitment requires legitimacy in terms of how processes are step up and run, and the efficacy of governance. Second, the respective strength of various types of instruments in a 'policy mix' should be taken into consideration to discern their impact on the way in which specific ideas are taken up and interpreted in the policy process (Flanagan et al., 2011: 705), and hence how they influence the adoption of the policies and the subsequent development process.

Here we analyze the shifts in regulation regimes, asking: Have the policy mixes and shifts in regime given the intended impact on a swift transition toward zero carbon? The approval in 2002 of the EU Energy Performance of Buildings Directive, EPBD, (EC 2002/91) is used as milestone and critical junction of the *longue durée* of development of building policy and regulation. The approval of EPBD marks a landmark change from predominantly national building regulation into a combined national and over national European regulation.

2. METHODS

The approach adopted is interpretive sociology, including understanding of micro-processes, enterprise, sector, society and global phenomena. This broad scope is adequate given our research objective. It also implies drawing on political science approaches to policy making, law and public regulation. Relevant policy areas include sustainability, climate, energy, innovation and building. In developing the framework of understanding, several theoretical strands were examined in a preliminary review, including institutional theory (DiMaggio and Powell, 1983), governmentality (Jessop, 2006), metagovernance (Sørensen and Torfing, 2009) and multilevel theory (Geels, 2002). The empirical material used draws on a palette of sources of archival character (Ventresca and Mohr, 2002). Largely the implementation of EPBD in 2002 until present day is the scope of investigation. Both authors have been active researchers in this period 2002-2017. Research has covered single (micro) projects and national policies, to the over-national EU regulation and global developments (e.g. Jensen et al 2011, Koch and Buser 2006). One author has been active in regulation preparation processes in Denmark. The other author has followed the Swedish development from Denmark 2002-2012 and from 2012 from an employment in Sweden in construction research. It is a limitation that this research builds on existing material and results. In particular, it is dependent of other evaluations of the progress of making the building sector. We have however attempted to deal with these issues by including a range of archival documents that are contemporaneous with the events under scrutiny, including policy papers, government reports, laws, hearing statements, scientific reports and newspaper articles.

3. THEORETICAL FRAMEWORK: POLICYMAKING AS POLITICAL PROCESS

The theoretical framework that has been adopted to enable the analysis of the dynamics and relationships between the instruments employed in developing the field of sustainable building in Sweden and Denmark. For this purpose, a combined political framing / innovation policy perspective (Hoffman and Ventresca, 1999; Edler and Georghiou, 2007) is chosen due to its understanding of (i) the coupling from policy intention to building sector development, (ii) the

role of political volition; and (iii) the framing of potential objects of regulation. The central argument of the political process perspective is that social decisions and change processes are open-ended and emergent in character; and that actors' strategies and politics, the ability to build coalitions, and to include and exclude others, are central to the outcome of the process, here the policymaking and regulation design (Kelly and Palumbo, 1992). In our conceptualization of the political process perspective actors' strategies and capabilities are dependent of the political volition they are able to build. The content of the strategy moreover involves a framing which is important for the strength of the politics (Entman, 1993).

3.1 Innovation policies and policy instruments

In order to promote growth and sustainable development a series of more or less concerted initiatives and steps have been taken the last 30 years on multiple levels ranging from European legislation to national development programs and social action at the local and individual levels. The inclusion of multiple actors at different levels can be seen as a response to two interrelated societal developments. The first is a consequence of the increasing globalization or hyper complexity of society leading to a "...dispersal of power from traditional state actors [which] makes it harder for policy-makers to use traditional direct levers [while] expectations about the scope for public action remain high" (Flanagan et al., 2011: 703). Second, the challenges faced by the construction industries across Europe are highly ambiguous in that there is no definitive formulation of a root problem, and there are many different stakeholders and decision makers with conflicting values that frame the problem in multiple ways by mobilizing contending or even contradictory logics in the process. Notwithstanding, creating climate responsible buildings have moved to the center stages of political ambitions of contemporary sustainability policies with planners and policy makers at European and national levels seeking to realize the broad ambition through a broad spectrum of regulatory means and innovation policies. Edler and Georghiu (2007) thus argue that innovation policy since the 1990s has been perceived to act on and improve the performance of innovation systems. In this perspective governments intervene due to market and system failures by means of policies aimed at "...optimizing the interaction of various 'components of the system' [...] and at creating innovation-friendly framework conditions" (Edler and Georghiu, 2007: 952). The range of policy measures employed to induce innovation or speed up the diffusion of innovation is diverse and includes both supply-side and demand-side measures. Supply-side measures can be divided into services and financial instruments, e.g. fiscal measures and mobility support, whereas demand-side innovation policy tools can be defined as "...all public measures to induce innovations and/or speed up diffusion of innovations through increasing the demand for innovations, defining new functional requirement for products and services or better articulating demand" (Edler and Georghiu, 2007: 952). This includes public procurement and stimulation of private demand and, the focus of next section, use of regulations that set targets for innovation and the creation of framework conditions conducive to market uptake of innovations.

3.2 Governance from regulation to self-regulation

Legislation has traditionally been an important instrument in the hand of policy makers, however as argued by e.g. La Cour and Andersen (2016) policy making is no longer solely a government matter, but also something that involves and can be driven by variety of different actors, including industry boards and quangos, social movements and consumers and

(inter)national organizations. Therefore, it is not only regulation in guise of ‘hard’ legislation that affects the development of innovation and sustainability building across European construction industries. A central tenet of sustainable development is that it is closely related to new forms of regulation – a change that often is referred to as ‘from government to governance’ (Jensen and Gram-Hanssen, 2007). Thus, as previously argued, the increasing societal hyper complexity has led to a dispersal of power from traditional state actors making it harder, or less legitimate, to use traditional direct regulatory (legislative) means. Danish construction policy for instance aims directly at ‘strengthening the quality of regulation’ in the construction industry – being a misnomer for a deregulation and marketization of functions that hitherto have been public affairs. Instead governments have begun to favour more mixed or hybrid approaches to regulation, where legislation is only one policy tool among several. The Australian Government’s Best Practice Regulation Handbook distinguishes between self-regulation, quasi-regulation, co-regulation, and explicit government regulation (legislation). According to Black (2001: 117) this distinction is made on the basis of the legal status of the rules and on the relationship between government and industry. Regulation can be defined as “...any ‘rule’ endorsed by government where there is an expectation of compliance“ (Australian Government, 2010: 9). This includes primary legislation and international treaties (and for the purpose of this paper also European directives and regulations) as well as other means by which governments influence businesses and the not-for-profit sector to comply. Quasi- and co-regulation refer to arrangements where the government influences businesses to comply or provides legislative underpinning to regulate and enforce. Finally, self-regulation can take the form of e.g. industry-formulated rules where the industry is solely responsible for enforcement.

3.3 Substantive and reflexive law

In addition to the traditional ‘hard’ legal mechanisms, such as law and contracting, of the legislative regulatory approach, governance by co-, quasi- and self-regulation draw on various types of soft law, incentives, guidelines and brokering activities (author reference). Standardization, in the form of norms and voluntary agreements (Jensen and Gram-Hanssen, 2007), play a prominent part in governments’ efforts to govern at distance or govern “...the self-regulation of the interactions among stakeholders and [strategically directing] the capacities of the involved actors towards its own policy agendas” (LaCour and Andersen, 2016: 907). This form of meta-governance rests on fundamentally different legal logics than traditional forms of governance. Teubner (1983), drawing on a Luhmanian understanding of self-regulating (autopoietic) systems, views the development of policy and regulation making as evolutionary. Later modern law is better perceived as two distinct phases; the first being ‘material law’ and the second ‘reflexive law’. Material law, or substantive law, as it is called in English translation (Teubner 1983), is at the one hand having broad goals and using specific direct means to achieve the goals. Reflexive law at the other hand is having broad goals, too, but using indirect means to achieve the goals. Substantive law directly regulates social behavior by defining substantive prescriptions, and the role of the political system is to take responsibility for defining goals, selecting normative means, and prescribing concrete actions (therefore also called prescriptive law, Antonsen et al., 2017). In the evolutionary scheme the ‘reflexive law’ develops as a reaction to the lack of success of - or at least the lack of further potentials for - the material law. The complexity of society outgrows the possibilities of the legal system to shape the complexity into a form, fitting to goal-seeking direct use of the law. A reflexive regulation tries to work through the procedures and institutions, which have an influence on the conditions that are subject to regulation. Reflexive regulation thus uses ‘procedural forms of law’.

3.4 Policy mix for sustainable development

Based on the above framework, we suggest that the different types of instruments used in regulating a given policy field can be conceptualized in terms of a ‘policy mix’ (Flanagan et al., 2011) that encompasses a variety of means, and encompasses a belief that a particular mix of means will give instrumental results. The various instruments/means posited in such policy portfolios can be characterized in a continuum ranging from ‘hard’ regulation (i.e. legislation), which exhibits a strong coupling between policy intentions and specific targets for building sector development, to self-regulation, or ‘soft’ measures with a weaker coupling from policy to building sector. Figure 1 below illustrates this policy mix continuum and selected dimensions.

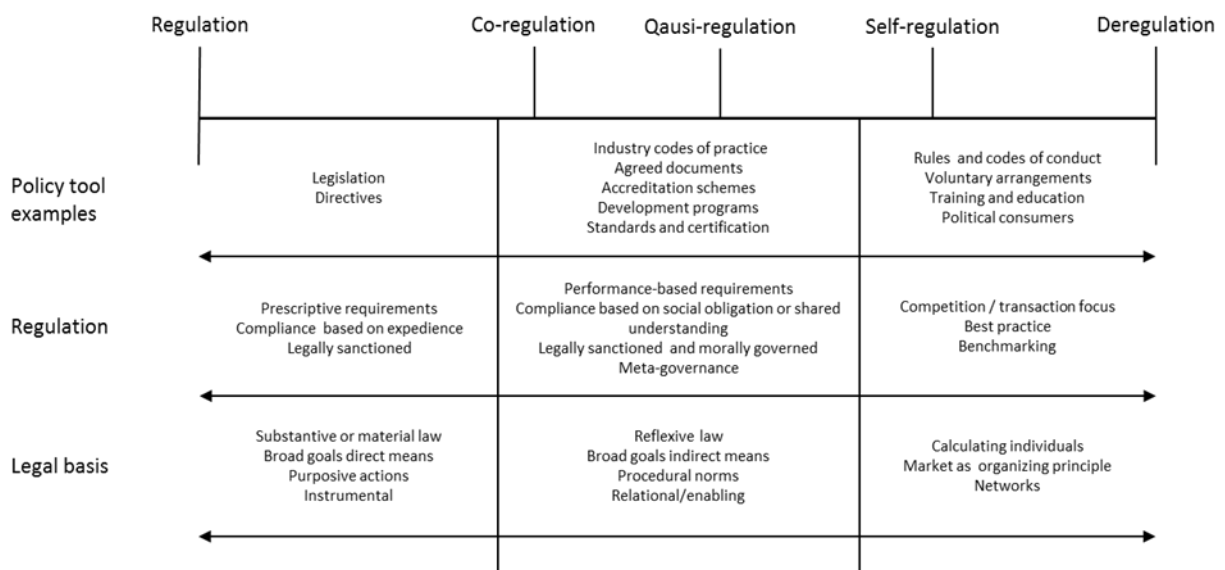

Figure 1. Policy continuum and elements of the policy mix (authors)

The term ‘policy mix’ puts emphasis on the interactions between different policies “...as they affect the extent to which intended policy outcomes are achieved” (Flanagan et al., 2011: 702). Such a hybridization of regulatory modes and instruments is increasingly gaining importance as a means to improve public regulation, however as Dorbeck-Jung et al. (2010: 154) argue it is still unclear whether combinations of hard law and soft law, co-regulation, and legally enforced self-regulation really make regulation more effective. Moreover there is still much to explore and understand when the ambition goes beyond merely describing the means of the mix and approaching how they interact and are coordinated (Flanagan et al., 2011). The following analysis will make use of the above framework in an analysis of the relationship between policy mix and sustainable development in Denmark and Sweden. This mapping is a first step in the analysis, followed by an evaluation of strength in the measures.

4. CASES

In this section, we analyze the ‘policy mix’ and the interactions between the between different policies and instruments in the development of the field of sustainable buildings in Denmark and Sweden, and how the coupling between European and national regulation has played out. The analysis proceeds chronologically with a description of the development in three phases from 2001 to present day characterized by different dynamics. We end each analysis by

summarizing the type and character of the instruments employed, and their contribution to the process of improving sustainability.

4.1 Denmark

Phase 1: 2001-2010: In a Danish context, energy savings have been on the construction agenda for more than 50 years since a minimum insulation requirement was introduced in the building code in 1961 as a response to a brief rise in oil prices after the Suez war (Lauridsen and Jensen, 2013). In the following decades, these requirements were successively tightened until 1995, where the hitherto formulated requirements concerning U-values for construction elements were replaced by maximum thermal energy requirements for heating and ventilation, and later by ‘energy performance frameworks’ for the entire building (DECA, 2008) thus moving focus away from components and towards the performance of the building. Where the regulatory underpinning of the energy requirements in the first half of the 2000s primarily was based on prescriptive requirements formulated in the building code, the development of the requirements was guided by a rather weak-coupled anticipatory policy formulation. Thus in 1990, the Danish government released their third national energy plan, ENERGI 2000, in which the Danish government made binding obligations to work towards reducing the heating requirement in new-build housing by 50 % by 2000. In the governmental energy action plan, Energi 21 (Regeringen, 1996), it was argued that the 1995 building code would lead to a 25 % reduction and that there was a need to revise the building code in order to reduce the ambitious 50 % energy reduction target. In 2005 the building code was revised setting a new target for energy consumption by 2010 and 2015 as a direct consequence of the transposition of directive 2002/91/EC, the energy performance of buildings directive (EPBD), which marked a turn towards a strong-coupled interaction between European and national policy. Article 4 of the 2002 EPBD, however, still placed the responsibility for developing necessary measures to ensure that minimum energy performance requirements for buildings were set in the hands of the Member States. In Denmark these minimum requirement were formulated into specific energy savings targets in a proposal for a parliamentary decision to halve the energy consumption in buildings. Drawing on the previous energy plans and an industrial action agenda for sustainable development (Byggepanel, 2001), a series of substantive targets were proposed, most notably that the total energy consumption in all new buildings has to be reduced with 20 % by 2005 and 50 % by 2020. It was thus stated that there was a need to be visionary and surpass the 2008-2012 time frame given in the Kyoto protocol. Moreover, it was argued that nothing would hinder Denmark in exceeding the requirements of the directive and arrange for additional policy instruments in support of the ambition. Even though the proposal in its full form was rejected by the liberal Danish government, central elements found their way to the new building code that saw the implementation of two new voluntary low energy building classes (Class 2 and Class 1) that were 25 % respectively 50 % more energy efficient than the formal prescriptive requirement of 84,6 kWh/sq. m. pr. year (for a 150 sq. m. residential building). The rationale behind these voluntary classes was to provide indicative forecasts for the tightening of the energy requirements in 2010 and 2015 – thus providing the industry with a ‘training ground’ for future expectations. In addition to the realized and anticipated tightening of the energy requirement other primarily ‘soft law’ policy instruments were implemented as a result of the action plan, including energy performance certificates, energy savings scheme and a reorganization of the national information campaigns. These gave important impact, also of anticipatory character until 2008. The crisis struck hard both on building activities and innovation of energy efficient and sustainable buildings.

Phase 2: 2010-2015: In 2010 the new EPBD (Directive 2010/31/EU) was introduced leading to yet a revision of the building code. Energy requirements for new buildings were tightened by 25 % as planned, with the former low energy class 2 becoming the new minimum requirement, and a new low energy class 2015 introduced. Initially no forecast, for a 2020 energy performance requirements were included leading to a halt of the anticipatory regulatory approach. As (Thomsen, 2014) explains, a united building industry, requested a forecast leading to a process of establishing cost-benefit analyses for different levels of energy performance requirements. This eventually formed the 2020-requirements for buildings, also known as the Danish Nearly Zero-Energy Buildings (NZEB) definition announced in 2011 with a foreseen required energy consumption of 20 kWh/sq. m. per year.. Concurrent with this development, the construction industry increasingly discussed the choice of a preferred certification system for sustainable buildings in Denmark, including the internationally recognized certification systems LEED, BREEAM, DGNB and HQE. In 2011 a demonstration / development program (Mini CO2 Houses) was initiated with the ambition of demonstrating how to reduce resource consumption and hence reduce CO2 emissions in the different phases of a building life-cycle and in 2013 the use of oil and natural gas in new building was disallowed in order to reduce the use of oil and natural gas for space heating.

Table 1. Policy mix in the Danish development

Continuum	Policy tool	Phase 1 2001-2009	Phase 2 2010-2015	Phase 3 2015-2020
Regulation (strong coupling)	Law, rules	Prescriptive requirements Anticipatory until 2008	Anticipatory requirements Prescription 2020	Legislative vacuum?
Co and quasi-regulation	Sector agreements	Industry reports	NZEB definition formulated	
	Standards, certification	Not important	Development period	
	Public authority as political consumer (demand)	Frequent energy strategies	None	Public projects as front runners
	Development programs and subsidies	Energy labelling Energy savings scheme	Minor near zero carbon demonstration program	
	Education and training	Energy consultants	Cont.	Cont.
Self-regulation (weak coupling)	Deregulation	None	None	None

Phase 3: 2015- 2020: In 2015 the building code was updated again as foreseen, with the former low energy class 2015 requirements becoming the new requirements as it was anticipated years earlier. Moreover This 2020 building class is expected to be an obligatory requirement for new-build public buildings by 2020 and in the rest of the market by the end of 2020. This requirement constitutes a strong coupling from European to Danish regulation as article 9 of the EPBD specifically requires that: “Member States shall ensure that (a) by 31 December 2020

all new buildings are nearly zero-energy buildings; and (b) after 31 December 2018, new buildings occupied and owned by public authorities are nearly zero-energy buildings” (EC, 2010). The requirements are a part of the government’s energy strategy 2050 to reach the binding obligation of reducing CO₂-emissions and increasing the share of renewable energy sources to 30 % by 2050. In reaching this common EU target, a policy mix consisting of “...standards, taxes, subsidies and labelling schemes were applied in steering Danish society” (Zhang et al., 2016: 610).

Three policy instruments in particular targeted the construction industry. Two of these are ‘hard’ legislative instruments, namely the building code and an act concerning the acceleration of energy savings in buildings, whereas the third is ‘soft’ in the form of the establishment of a knowledge center for energy savings in buildings (KEMIN, 2010). Another development in 2015 onwards was the focus on energy refurbishment as a driver for reaching the ambitious targets.

According to Thomsen et al. (2015) the national strategy for the renovation of existing buildings was developed on the basis of a collaborative network process involving key stakeholders in the formulation of targets and instruments. Table 1 above illustrates the policy mix employed in the Danish development of sustainable housing.

4.2 Sweden

Phase 1: 2001-2006: The building stock in Sweden has gradually moved into concrete and steel based structures with less emphasis on wood since the Second World War. Energy prices have been relatively independent of world market developments due to hydro and atomic electrical power being central in Swedish energy policy. The EU approval of EBPD in 2002 was received as compliant with existing energy performance legislation in Sweden and therefore evaluated as having minor impact in Sweden (SBI rapport). A period of six years without reforms followed 2002 -2006.

Phase 2: 2006-2009: The implementation of EBPD 2002 in Sweden commences in 2006, by government employing energy performance regulation separately on electrically heated and non-electrically heated. By 2006 75 kWh per m² was allowed in electrically heated houses, and 110 in non-electrically heated. By 2009 this was revised to 55 kWh for electrically heated houses (27% reduction) and 110 in non-electrically heated (unchanged).

In this period Sweden also saw the emergence of voluntary certification such as “Miljöbyggnad”, BREEAM, LEED and Passive House. Until 2010 realisations were less than twenty of each. The law revision in 2006 also commenced the implementation of the other measures of EBPD 2002. This included first of all energy declarations and related inspection systems, qualified inspectors, information campaigns subsidies and incentives (CA BOK, 2012). Subsidies were small, less than 10 million Euro each but included solar energy, conversion of direct electricity heating, windows, biofuel boilers, renewable energy projects in public buildings (CA BOK, 2012: 303). “Expert companies” (CA BOK, 2012) was accredited to do the inspection of the declaration. From 2007-2009 the energy declaration was implemented in public buildings larger than a 1000 m², using a seven step scale from small to large energy consumption [different from the A-G scale]. In 2009, the energy declaration was implemented for new buildings and all buildings that were put for sale.

Phase 3: 2010-2016: In 2010 EU sharpened its rhetoric on energy reduction launching the notion of “Near Zero Carbon Buildings”. By 2012 the Swedish energy performance legislation still at 55 kWh per m² for electric heated houses, and sharpened from 110 to 90 in non-electrically heated (a reduction at 18%). From 2011 “Miljöbyggnad” certification gained momentum and by 2015 counted some 500 certified buildings. Passive Houses, LEED and BREEAM remained limited in numbers. In 2014 Boverket changed the energy declarations, introducing class A-G (now similar to other EU countries (Karlsson Hjort et al 2015). From 2014-2017 a demonstration program running of near zero carbon building (120 mio Swedish kroner) was launched together with evaluations of low energy buildings (indoor climate), and proposals for measurement of energy consumptions. In 2015 energy performance regulation was split into single family houses and multifamily houses, demanding the latter to perform at 50 kWh per m² for electric heated. Boverket proposed in 2015 a Swedish interpretation of what “near Zero Carbon” should be. The proposal was a prolongation of existing legislation at the time.

Table 2. Policy mix in the Swedish development

Continuum	Policy tool	Phase 1 2001-2006	Phase 2 2006-2009	Phase 3 2010-16	Phase 4 2016-
Regulation (strong coupling)	Law, rules	passivity Absence of anticipatory	substantive	Reflective	Substantive regulation
Co- and quasi- regulation	Sector agreements				
	Standards certification	Non important	Present but not important	Miljöbyggnad gains momentum	Revision of Miljöbyggnad
	Public authority as political consumer (demand)		Not in focus	Energy strategies developed in public authorities	Public projects compliant with stricter regulation
	Development programs and subsidies	Minor subsidies	Minor subsidies	Minor demonstration programs of NZC and subsidies	Minor subsidies continue
	Education and training			A need for 100.000 craftsmen to be trained (Build Up)	
Self- regulation (weak coupling)	Deregulation	None	None	None	None

Phase 4: 2016- : In November 2016, a new energy performance threshold was implemented at 30 kWh per m² for single and multi-dwellings and villas. This was remarkable stricter than the previous 50-90 kWh per m². Also revisions in calculation methods and a range of other

performance threshold were implemented. A demand for 30 kWh per m² was, however, by Boverket 2015 estimated to risk leading to strong negative consequences due of lack of technology and competences (Boverket, 2015). Table 2 illustrates the policy mix employed in the Swedish development of sustainable housing.

5. ANALYSIS AND CONCLUSIONS

In Denmark, the reliance on Energy plans is a typical cooperative parliamentary politics process, as broad involvement in legislative initiatives are perceived to lead to longer term stability. This understanding creates legitimization to the anticipation of the future stricter level from 2005 to 2008, creating an environment for advancing building method and technologies, by means of numerous demonstration projects at stricter energy performance level. The near zero carbon directive (2010) coincided with a new period of volition in Denmark, recovering from the crisis. The anticipatory drive of the coming 2020 legislation however loses steam in 2015-2016 (hence the “” around 2020 in the table). Table 3 summarizes the main phases in the Swedish development of the field of sustainable housing.

Table 3. Main phases in the Danish development of sustainable housing

	Phase 1	Phase 2	Phase 3
Time	2001-2010	2011-“2020”	2015-2017
Main characterisation	Substantive Anticipatory	Substantive Anticipatory	Vacuum
Coupling	Strong	Strong	None
Volition	Present	present	Absent
Framing	Compliance with EU	DK can move ahead globally	Limbo

In the initial period the Swedish building community did have an opportunity to go beyond the rest of Europe creating a laboratory for sustainable buildings, which could have made a platform for a building cleantech business development. The development, however, made Sweden stay in a compliant mode vis-à-vis EU development. In this period the Swedish industry therefore lost international competitiveness. This reluctance to move forward is what we denote the “fat cat” tendency. The substantive law regulation is maintained roughly at the same level in a relatively long period from around 2000 to 2012. Anticipative announcement of later stricter regulation was not used, neither adopted as legitimation for non-governmental authorized experimenting. The absence of a 2008 crisis in the Swedish economy actually only prolonged this relative passive period. The EU 2010 “near Zero Carbon” directive does not induce remarkable change, until 2016. The substantive regulation in 2016 is relatively surprising and can be seen as a result of lobbying from stakeholders, but not as a broad inclusive negotiation. Table 4 summarizes the main phases in the Swedish development of the field of sustainable housing.

When comparing the cases, it is interesting to note that in a period of a common supranational legislation the two countries have been able to follow different paces in the the development even if convergence does occur relatively strongly in terms of content of the legislation.

The main *divergence* between the two timelines of regulation is the differences in speed of rhythm in the implementation. But the comparison also reveal continued differences in for example the substantive law element. The inclusive or reflexive governance approach is usually a feature of both the Danish and Swedish development efforts. However in this case the

Swedish implementations more take character as technical EU directive implementation when needed, whereas several steps of the Danish development develops specific inclusive compromised with stakeholder.

Table 4. Main phases in the Swedish development of sustainable housing

	Phase 1	Phase 2	Phase 3	Phase 4
Time	2001-2006	2006-2010	2010-2016	2016-
Main characterisation	Fat cat	Substantive	Performative	Substantive
Coupling	None	Strong	None	Signs of stronger coupling
Volition	Absent	present	Absent	Present
Framing	Sweden leading in the world	Compliance with EU	Liberal economists	Renewed Political Volition

Zhang et al. (2016: 611) thus argue that the current institutional frameworks and lines of responsibility between central and local governments in Denmark are well defined for municipal energy planning, and that this creates a “...legitimate way for interdependent actors to participate in establishing ZEBs policies,” thus helping to elicit high-level political support and unified action in a situation where the absence of strong political volition and direct prescriptive regulations after 2020 has resulted in an legislative vacuum. The main *convergence* is that both countries regulation has tended to emphasise energy efficiency over sustainability in the policy mix. Also the elements in policy mixes, such as substantive law and energy declarations have in periods appeared more and less disconnected. Both countries found ways to resonate with the EU framing. This means, when bringing the analysis up to contemporary times that the absence of new remarkable initiatives since 2010 creates a vacuum, which have first been used by memberstates to reach a compliance with a 2010 level of ambition. But second once the competences and technologies available continues to be developed, it creates a present policy vacuum, where opportunities in 2017 are beyond the 2010 level of ambitions for 2020 and therefore new regulation could be implemented. The anticipative institutionalisation of energy efficient building from 2002 to 2008 and again 2011-2015 in Denmark is telling. Even if the results are not uniquely impressive, it can be derived that performative regulation better respond to the continual process of improving sustainability.

6. REFERENCES

- Antonsen, S., Nilsen, M. and Almklov, P. (2017) Regulating the intangible. Searching for safety culture in the Norwegian petroleum industry, *Safety Science*, vol. 92, pp. 232-240.
- Australian Government (2010) Best practice regulation handbook, June 2010, Canberra, Commonwealth of Australia.
- Birgisdottir H. , Mortensen L.H., Hansen K. and Aggerholm S. (2013) Kortlægning af bæredygtigt byggeri. SBI København.
- Boverket (2015) Förslag till svensk tillämpning av nära-nollenergibyggnader Definition av energiprestanda och kvantitativ riktlinje. Rapport 2015:26 Regeringsuppdrag. Boverket. Stockholm
- Byggepanel (2001) Handlingsplan for en bæredygtig udvikling i den danske byggesektor, Byggepanel, DK.
- DECA (2008) Building Regulations 2008, DECA (Danish Enterprise and Construction Authority), The Danish Ministry of Economic and Business Affairs, Copenhagen.
- DiMaggio, P.J. and Powell, W.W., 1983. The iron cage revisited: institutional isomorphism and collective rationality in organizational fields. *American sociological review*, 48 (2), 147–160.

- Dorbeck-Jung B. R., Vrielink M.J., Gosselt J.F., van Hoof J.J., de Jong M. (2010) Contested hybridization of regulation: Failure of the Dutch regulatory system to protect minors from harmful media. *Regulation and Governance*, 4, 154-174.
- EC (2010) Directive 2010/31/EU of the European Parliament and of the Council on the energy performance of buildings. EC (European Commission), Brussels.
- EU (2011): Implementation of Energy Performance of Buildings Directive -Featuring country report 2010. Concerted Action EPBD. Bruxelles.
- Edler, J. and Georghiou, L. (2007) Public procurement and innovation – Resurrecting the demand side, *Research policy*, 36(7), 949-963.
- Entman, Robert M. (1993). Framing: Toward Clarification of a Fractured Paradigm, *Journal of Communication*, 43 (9), 51-58.
- Flanagan, K., Uyerra, E., & Laranja, M. (2011). Reconceptualising the ‘policy mix’ for innovation, *Research policy*, 40(5), 702-713.
- Geels, F.W. (2002) Technological transitions as evolutionary reconfiguration processes: a multi-level perspective and a case-study, *Research policy*, 31(8), 1257-1274.
- Hoffman, A.J. and Ventresca, M.J., (1999) The institutional framing of policy debates: economics versus the environment, *American behavioral scientist*, 42 (8), 1368–1392.
- Jensen, J.O. and Gram-Hanssen, K. (2007) Økologisk modernisering af bæredygtigt byggeri. In: Jesper Holm, Lars Kjerulf Petersen, Jeppe Læssøe, Arne Remmen and Carsten Jahn Hansen (Eds.) Økologisk modernisering på dansk. Brud og bevægelser i miljøindsatsen. Frydenlund, København, pp. 349-377.
- Jensen, J.S., Gottlieb, S.C. & Thuesen, C.L. (2011) Construction sector development: frames and governance responses, *Building Research & Information*, 39 (6), 665-677
- Jessop, B. (2006) From micro-powers to governmentality: Foucault's work on statehood, state formation, statecraft and state power, *Political geography*, 26(1), 34-40.
- KEMIN (2010) National handlingsplan - For vedvarende energi i Danmark, Juni 2010, KEMIN (Klima- og Energiministeriet) København.
- Karlsson Hjorth, H., Lindén, S. Antonsson R., Linton S. (2015) Implementation of the EPBD in Sweden: Status in December 2014. In Eduardo Maldonado (Ed.) *Implementing the Energy Performance of Buildings Directive (EPBD): Featuring country reports*, Lisbon: Portuguese Energy Agency (ADENE), pp. 533-542.
- Kelly, R.M. & D. Palumbo (1992) Theories of policy making. In Hawkesworth, M. & M. Kogan: *Encyclopedia of Government and Politics*. Routledge, London.
- Koch C & Buser M (2006) Emerging Metagovernance as an Institutional Framework for Public Private Partnership Network in Denmark. *International Journal of Project Management*. Special Issue on Public Private Partnerships. 24(7), 548-556
- La Cour, A., & Andersen, N. A. (2016). Metagovernance as Strategic Supervision. *Public Performance & Management Review*, 39(4), 905-925.
- Lauridsen, E. H., & Jensen, J. S. (2013). The strictest energy requirements in the world: An analysis of the path dependencies of a self-proclaimed success. *Energy policy*, 53, 97-104.
- Regeringen (1996) Energi 21 - Regeringens energihandlingsplan 1996, Miljø- & Energiministeriet Energistyrelsen, København.
- Stilgoe, J., Owen, R. and Macnaghten, P. (2013) Developing a framework for responsible innovation, *Research Policy*, 42(9), 1568-1580.
- Sørensen, E. and Torfing, J. (2009) Making governance networks effective and democratic through metagovernance, *Public administration*, 87(2), 234-258.
- Teubner, G. (1983): Substantive and reflexive elements in modern law. *Law and Society Review*, 17,239-85.
- Thomsen, K.E. (2014) Danish plans towards Nearly Zero Energy Buildings. *Rehva Journal*, 51(3 May) 6-8.
- Thomsen, K.E., Wittchen, K.B., Ostertag, B., Bruus Varming, N., Thers Egesberg, L., and Hartung, T. (2015) Implementation of the EPBD in Denmark: Status in December 2014. In Eduardo Maldonado (Ed.) *Implementing the Energy Performance of Buildings Directive (EPBD): Featuring country reports*, Lisbon: Portuguese Energy Agency (ADENE), pp. 243-258.
- Zhang, J., Zhou, N., Hinge, A., Feng, W., & Zhang, S. (2016). Governance strategies to achieve zero-energy buildings in China. *Building Research & Information*, 44(5-6), 604-618.
- Ventresca, M. and Mohr, J.W., 2002. Archival research methods. In: J.A.C. Baum (Ed.) *The Blackwell companion to organisations*. Oxford: Blackwell, pp. 805–828.

APPLICABILITY OF SAFE WORKING CYCLE (SWC) CONCEPT TO SRI LANKAN CONSTRUCTION INDUSTRY

N.S.K. Mendis, P.A.D. Rajini, A. Samaraweera and Y.G. Sandanayake

Department of Building Economics, University of Moratuwa, Moratuwa, 10400, Sri Lanka

Email: kasun686@gmail.com

Abstract: Safe Working Cycle (SWC) is a Japanese concept, which incorporates safety management into the construction management system for enhanced construction safety. Thus, this study focuses on investigating the applicability of SWC concept to Sri Lankan construction industry. The aim was approached through a sequential mixed research design. Data were collected through a questionnaire survey and expert interviews conducted among safety officers in construction projects in Sri Lanka. Data were analysed using Relative Importance Index and Content Analysis. Research findings reveal that though the SWC concept has not yet been initiated in Sri Lanka, currently there is relatively a very high to moderate level exercising of some SWC related practices. Major benefits of implementing SWC concept in Sri Lankan construction industry include; improvement of safety habits of workers, identification of potential hazards and improvement of housekeeping practices within the construction sites. Further, tight project schedules, poor participation of staff in safety related practices, and limited space for carrying out daily safety meetings and exercises are the major barriers identified for SWC implementation. However, due to the enabler of SWC related aspects are already being in practice in Sri Lankan context, SWC concept can be easily applicable to the Sri Lankan construction industry with appropriate means of knowledge transferring.

Keywords: Construction Industry, Construction Safety, Safe Working Cycle (SWC), Sri Lanka

1. INTRODUCTION

Construction safety management has received an increased attention in research and practise in construction industry due to higher rates of accidents being reported (Guo, *et al.*, 2017). Halwatura, and Jayatunga (2013) indicate that health and safety conditions of Sri Lankan building construction industry are at an unsatisfactory level resulting heavy loss of time, cost and resources. Following a critical review of literature, Vitharana, *et al.* (2015) identify that workers falling from height, electric shocks and exposure to hazardous substances as the main health and safety hazards reported in Sri Lankan building construction industry. They suggest that the main causes of accidents in building construction sites as lack of awareness on site safety and the dislike to wear personal protective equipment. Thus, they argue on enhancing the awareness and active participation in safety management by professionals in construction industry as a mean of overcoming the said safety issues.

As the outcome of a thorough analysis on perceptions, attitudes, and behaviours of construction related workers and the management of safety practices, Darshana (2017) emphasises the necessity of a proper health and safety policy for every construction related project and organisation, bringing in proper modifications to the traditional safety management systems in Sri Lankan context. Darshana (2017) further suggests developing a positive health and safety culture as the key to a safer working environment in construction. Among different safety management tools, Safe Working Cycle (SWC) has been identified as a concept introduced by Japanese to regulate its daily working process, providing a model for management to follow, and implement certain elements of the safety management system (Chan and Hung, 2013). Indicating the successful implementation of SWC in Hong Kong construction industry, Chan

and Choi (2015, p.16) elaborate that; “The SWC is one of the safety initiatives that has contributed to the decline of construction accidents and fatalities in Hong Kong, therefore proving that the SWC is successful and effective in improving site safety performance”. Therefore, as the traditional safety management systems followed in Sri Lankan context have not been much successful in satisfying the entire safety requirement of the construction industry, modification of existing tools and application of a new safety management tool such as SWC could be very much prudent to mitigate the prevailing unsafe working environment in Sri Lankan construction industry. Therefore, the aim of this research is to investigate the applicability of SWC concept to the Sri Lankan construction industry.

2. SAFETY IN CONSTRUCTION INDUSTRY

Construction site is a place where most of the hazards among all industries are available and therefore, construction workers are exposed to a wide variety of health hazards on the job (Nawi *et al.*, 2016). According to Rameezdeen *et al.* (2003), the ratio of fatal to non-fatal accidents in construction industry of Sri Lanka is 1:13 although, the ratio of fatal to non-fatal accidents in other industries is 1:115. Therefore, construction industry is mainly considered as the most fraught with danger in related to personal safety and health worldwide, including Sri Lanka. Hence, Nawi *et al.*, (2016) indicate that there is a negative stereotype concerning safety in the construction industry.

Construction related accidents lead to injury or loss of human life and damage to property and environment, which are associated with direct and indirect costs to organisations (Ahamed *et al.*, 2013). Accordingly, occupational accidents in construction industry cause economic and social problems in organisations, as well as in societies (Rubio *et al.*, 2005). Financial losses occur due to the impact of accidents and damages on plant, equipment and workers. Moreover, there is also a loss of productive work time until the normal site working environment and morale return to the initial state (Nawi *et al.*, 2016). Thus, ensuring of the construction safety is an essential and a tedious task (Priyadarshani *et al.*, 2013).

Various types of hazards controlling standards and regulations to ensure safety in construction are practiced in construction industry worldwide. For example, The Personal Protective Equipment at Work Regulations 1992 enacted in Great Britain provides provisions for compulsory wear of Personal Protective Equipment (PPE) at construction sites (Health and Safety Commission, Great Britain, 1992). Similarly, such standards and regulations ensuring safety in Sri Lankan construction industry include; Occupational Health and Safety Assessment Series (OHSAS) 18001:2007, International Labour Organization regulations, labour laws of the Labour Department of Sri Lanka under the Factories Ordinance (Ahamed *et al.*, 2013; Darshana, 2017). However, still the reported accident rate is high in the Sri Lankan construction industry. According to the information available at the Labour Department, every year, 2,500 - 3,000 accidents have been reported to the Industrial Safety Division of the Labour Department. Out of this number, 40% to 60% were fatal and from it, around 50% were from construction industry (Darshana, 2017).

Safety management includes both preventive and corrective actions to continuously improve the working environment (Darshana, 2017). Though the construction work is dynamic and complex and inherently dangerous, many risks can be avoided through the proper implementation of safe work practices. Organisations adopt different types of safety strategies to enhance site safety of workers (Hinze and Gambatese, 2003). Further, various safety strategies are assisted towards zero accident in construction sites (Hinze and Wilson, 2000). As

highlighted by Leichtling (1997), safety incentive programmes have been broadly implemented in construction industry, which contribute for employee motivation toward work safety. According to Chan and Choi (2015), safety incentive programmes are mainly applied to mitigate accidents, enhance safety behaviours among the workers and encourage to conduct safety related documents. Gangwar and Goodrum (2005) highlighted that main three objectives of implementing safety management tools are; convincing workers to adopt safer work practices, enhancing safety awareness among workers and reducing recordable accidents. OSHAS 18001 (Marhani *et al.*, 2013); Pay for Safety Scheme (PFSS); process transparency (Alarcon *et al.*, 2007) and Safe Working Cycle (SWC) are such popular safety incentives which have been implemented in construction industry in different nations.

3. SAFE WORKING CYCLE (SWC) FOR ENHANCED CONSTRUCTION SAFETY

Chan and Hung (2013) argue that an enhanced safety can be easily achieved in construction industry by means of building up a safety culture. They propose Safe Working Cycle (SWC) as the most popular and recent method of developing a safety culture in construction industry. Construction site safety handbook published by The Real Estate Developers Association of Hong Kong and The Hong Kong Construction Association (2005) also identify SWC as an effective method of promoting safety at construction sites.

SWC, which is also known as Site Safe Cycle (SSC) or Safety Work Cycle is a type of management tool that can be used to enable the organisation to regulate its daily working process, provide a model for management to follow and implement certain elements of the safety management system (Occupational Safety and Health Council, Hong Kong, China, 2002). According to Ozaka (2000), the SWC is a system, which incorporates safety management into the construction management system to integrate construction safety effectively. Moreover, the SWC is a system, which integrates safety into daily work. SWC has originated in Japan and it was promoted by the Japan Construction Safety and Health Association to construction companies in 1982 (Environment Transport and Works Bureau, 2002).

The aim of the SWC is to ensure a tidy work site and to promote safety awareness among construction workers by performing daily repetitive procedures that later form safety habits (Occupational Safety and Health Council, Hong Kong, China, 2002). As per Ozaka (2000), the goals that are expected to be achieved by implementing SWC are collaboration of contractor’s and sub contractor’s safety activities and incorporation of “safety” into “work”. Further, SWC encourages developing mutual trust between supervisor and workers and facilitates direct communication. In addition, the cycle enables workers to receive and accept relevant safety training and safety message, and ultimately creates a safety culture (Occupational Safety and Health Council, Hong Kong, China, 2002). ‘Daily’, ‘weekly’, and ‘monthly’ work cycles are the main three segments of SWC concept. These cycles clearly explain the responsibilities of each different worker/rank. The dominant aspects of SWC are given in Table 1.

Table 1: Dominant aspects of SWC

Element of SWC	Dominant aspects of SWC			
	Participants	Person in Charge	Equipment	Materials
Daily SWC				

Morning Safety Meeting	All workers	Project managers or site agent	Loudspeakers or other public address systems	Posters, safety leaflets, safety publications
Hazard Identification Activity	Every members of each group	Foremen	White board (if needed)	Operating manuals of the required working tools and equipment, sample of required materials and Materials Safety Data Sheet (MSDS) of chemical, hazards identification activity forms
Prior to Work Inspection	All workers	Individuals, plant operators, foremen, inspectors, maintenance group	Measuring/testing tools and repairing tool	Opening manuals for machineries and equipment, inspection checklist
Guidance and Supervision at Work	Team members	Foremen, group leaders or person in charge	Camera (if needed)	Hazard identification activity and monitoring form
Safety Inspection	Safety officers , Safety supervisors, foremen	Project manager or site agent	Camera (if needed)	Hazard identification activity and monitoring form, safety inspection checklist
Process Safety Discussion	Sub-contractor representatives, safety officers	Project manager	White board, projector, screen, camcorders	Record of process safety discussion
Tidying up After Work	All workers	Foremen, Supervisors	Brooms, Shovels, Garbage container, Wheel burrow, Storage containers	MSDS of cleaning agent
Final Check After Work	Foremen Sub-contractor representatives	Foremen or site agent	Flashlights, keys of the all gates	Final inspection checklist
Weekly SWC				
Weekly Safety Inspection and Weekly Check up	Project manager, Site agent, Safety officers, Representatives of sub-contractor, Plant operators, Electricians, Mechanics	Project manager	Camera (to record the inspection results), checking or repair tools	Safety inspection checklist, Machinery inspection check list
Weekly Process Safety Discussion	Workers representatives. Representatives of sub-contractor	Project manager	Meeting equipment	Inspection records of past week and current week
Weekly Tidying up	All workers on site	Foremen from the contractor and sub-contractor	Tools required for the weekly tidying up	Inspection checklist

Monthly SWC				
Monthly Inspection	Competent person appointed by the contractor and sub-contractor	Electricians, Mechanics	Testing meters	Maintenance manuals
Monthly Safety Training	All workers including workers of sub-contractor	Safety officer	All equipment required for training	Object required for training such as notes, materials for demonstration
Monthly Safety Meeting	All workers on site	Project manager	Loudspeakers or other PA system, Demonstration equipment	Daily morning safety meetings
Safety Committee Meetings	Safety officers, Representatives of sub-contractors	Project manager	All equipment required for the meeting	All documents required for the meeting

Source: Adapted from Chan and Choi (2015); Environment Transport and Works Bureau (2002); Occupational Safety and Health Council, Hong Kong, China (2002); Occupational Safety and Health Branch, Labour Department, Hong Kong (2002); Lam (2000)

SWC has been practiced more than 20 years in Japan (Environment, Transport and Works Bureau, 2002). SWC provides a model to management to follow and implement certain elements of the safety management system. After implementing the SWC, the Japanese construction industry exhibited exceptional progress in safety and health, and the number of accidents decreased significantly (Occupational Safety and Health Council, Hong Kong, China, 2002). Currently, China, Hong Kong, Singapore, United Kingdom and Japan are the countries, which mostly practice SWC concept in their construction projects. Further, Occupational Health and Safety Council of United Kingdom and Hong Kong published SWC hand Book to aware and establish SWC concept among workers who work in construction industry in order to generate a safe work place.

Chan and Choi (2015) elaborate on several benefits of implementing SWC in construction projects. These benefits include: enabling better understanding of site conditions and daily operations; facilitating safety-related communications between site management staff members and frontline workers; enhancing safety awareness of frontline workers; preventing the occurrence of construction accidents; establishing safety habits of frontline workers; improving site safety performance and housekeeping; elimination of compensation costs incurred by accidents; promote company reputation and image regarding having better site safety and identify potential hazards. Similar, benefits have been identified within extent literature include; reduced accident rate and improved safety-related communication (Occupational Safety and Health Council, Hong Kong, China, 2002); increased safety training (Chan *et al.*, 2005; Hinze and Gambatese 2003); stronger safety awareness and safety commitment (Tse, 2005).

According to Choi *et al.* (2012), common barriers in implementing SWC can be categorised under three major categories such as; challenges associated with workers, challenges associated with contractors and issues in prevailing subcontracting practice, which are listed as follows:

- (a) Challenges associated with workers
 - Low literacy level (Kheni, 2008; Koehn *et al.*, (1995)
 - Poor safety attitude and high turnover rate of workers (Chan *et al.*, 2005; Cheyne *et al.*, 1998; Kheni, 2008)

- (b) Challenges associated with contractors
 - Limited budget, human resources and facilities on site safety (Ahasan, 2001; Kheni, 2008; Mayhew, 2000)
 - Inadequate safety attitude of top managers (Toole, 2002),
- (c) Issues in prevailing subcontracting practice

In view of the facts cited above, SWC is one of the safety tools with number of benefits, which is contributing to reduce construction accidents and fatalities in Worldwide, if applied with proper attention to its inherited barriers. Further, the statistics of accidents given in Section 2 depict that Sri Lankan construction industry is one of the critical sectors that need a huge and fast overhaul from the current site safety practices. Therefore, it could be argued that SWC could be a better safety incentive, which could be considered for application in Sri Lankan construction industry. Therefore, the aim of this research is to investigate the applicability of SWC concept for construction industry in Sri Lanka.

4. RESEARCH METHODOLOGY

The research aim was approached through a sequential mixed method. According to Creswell (2009), mixed method approach improves the overall strength of the research as both quantitative and qualitative forms are being used. Within the sequential mixed method, initially, a questionnaire survey was carried out followed by some expert interviews. The purpose of the questionnaire survey was to identify the relative level of practise of SWC associated practices in Sri Lanka. Thirty number of questionnaire were distributed for this purpose and the respondents were the safety officers who were employed at building construction sites of the projects done by contractors with C1 or above grade for building construction (C1 is a categorisation of contractors in Sri Lankan context by the Construction Industry Development Authority of Sri Lanka. All major contractors are belonged to C1 or above categories). Questionnaires were filled by visiting the respondents in person to ensure the proper understanding of aspects of SWC concept by the respondents and 100% response rate was achieved. 1 to 5 Likert scale was used in data collection, where; 5 represents very high level of practice and 1 represents very low level of practice. The collected data were analysed using the Relative Importance Index (RII). As per the sequential mixed design, secondly, expert interviews were conducted to evaluate the suitability of SWC to Sri Lankan construction industry by identifying the benefits and barriers of implementation. Thus, semi-structured interviews were conducted with five subject matter experts to collect the required data. Content analysis technique was used for data analysis for expert interviews.

5. FINDINGS OF QUESTIONNAIRE SURVEY

The purpose of conducting a questionnaire survey was to identify the relative level of practise of SWC associated practices in Sri Lanka. Thus, SWC concept related occupation health and safety practices, which were currently practiced in Sri Lankan construction industry and their relative level of practice was questioned. The relative level of practice of each SWC related practice with their calculated RII values are depicted in Figure 1.

According to Figure 1, morning safety meeting (with an RII value of 0.95 and ranked as 1) is identified as the practices, which is mostly practiced related to SWC concept. In general, morning safety meeting is known as tool box meeting in which all the safety related issues and

day to day operations are discussed. All the workers namely project manager to labourers are involved in morning tool box meeting. According to the findings, hazard identification event is listed in second place with an RII value of 0.88. Hazard identification is important to identify hazards and to take necessary actions to refrain from the hazards. In each constructions site, a checklist, which is identical to them for hazard identification is maintained. Results of hazard identification are discussed in safety committee meeting and monthly safety meetings. Under the SWC concept, monthly inspection is identified related to the monthly cycle. In Sri Lankan context, monthly inspections is also practiced at a very high level. All the equipment, machinery, tools and materials are inspected by relevant supervisors by using checklists. Colour code system is also a part of monthly inspection and the machinery are marked with relevant colours after the inspections.

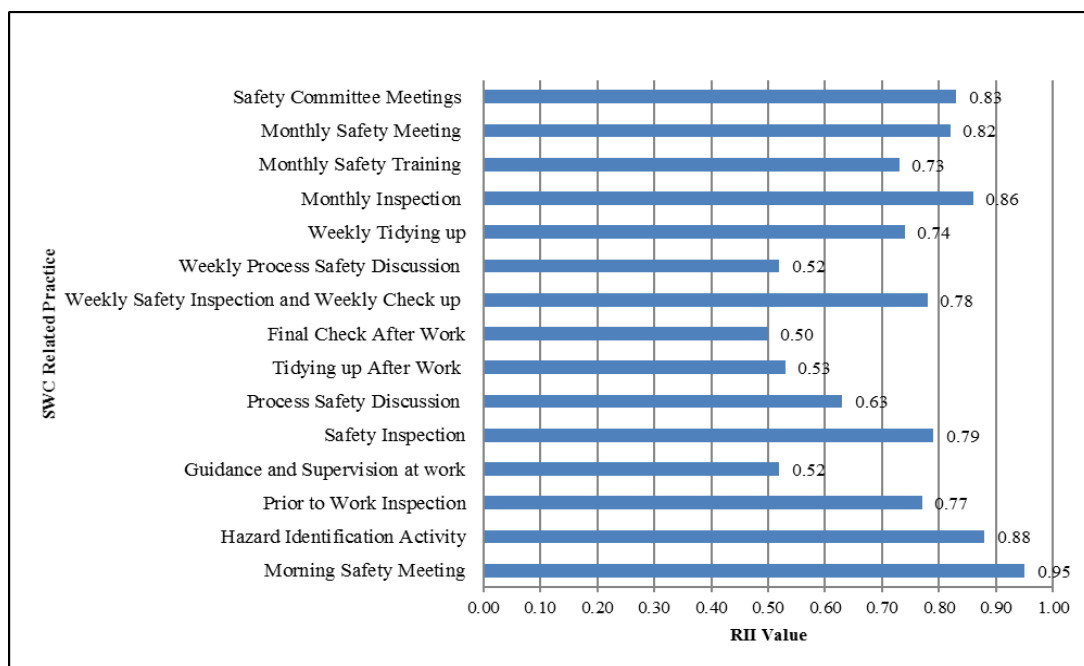

Figure 1: Relative level of practise of SWC associated practices

As the findings reveal, safety committee meetings and monthly safety meetings are also practiced at a very high level in construction industry in Sri Lanka. Project manager, safety manager, site manager and safety officer are compulsory to participate in committee meetings and all the safety related issues and action are discussed there. Further, safety plan for the upcoming months and referring of the past safety records are done during the safety committee meetings.

Monthly safety meeting is ranked as the fifth mostly practiced element among SWC related practices in Sri Lanka construction industry. RII value of monthly safety meeting is 0.82. Safety issues identified during morning safety meetings are discussed in detail in monthly safety meetings and the employees are provided an opportunity to present their problems and suggestion to build a better safety culture within the construction site. All the employees including the project manager participate in monthly safety meetings.

Weekly safety inspection and weekly check-up and prior to work inspection received RII values of 0.79, 0.78 and 0.77 respectively indicating a high level of practice in the construction industry in Sri Lanka. Basically, whole site and surrounding area of construction site are considered for safety inspection. Safety engineer and senior safety officer of construction site

are directly involved in safety inspection. Further, in Sri Lankan construction industry, all the scaffoldings and electrical installations are checked weekly to prevent any possible accidents. Sub contractors are also involved in this process. Throughout this process, it is easy to communicate information to management regarding safety issues. Prior to work inspection included inspection of all the equipment, machinery, tools and materials to ensure those are remaining safe and in proper condition before the start of work and usage of equipment. However, 'prior to work inspection' is carried out only for special tasks; such as work at height, hot works, excavations and high voltage electricity usage activities in Sri Lankan construction industry.

Findings revealed that weekly tidying up is mostly practiced in Sri Lankan construction industry than the daily tidying up after work. This is because, mostly the activities get delayed and rushing to finish work result in a difficulty to do site cleaning daily within the busy environment. Monthly safety training is listed in tenth place among the Sri Lankan SWC practices with an RII value of 0.73. Improving safety awareness, sharpening necessary skills, improving relevant knowledge regarding safety are main purposes of conducting monthly safety trainings.

Safety discussion in Sri Lanka construction industry are remaining at a low level compared to other safety practices. This is because, the time allocated for safety meetings and safety committee meetings are utilized by the management for progress reviews of the project without giving attention to the safety. In some emergency situations such as aftermath of a major accident, management is used to call upon safety discussions with safety managers and safety officers to discuss the prevailing situation and to identify means to mitigate such accidents in future. However, with a RII value of 0.63 it is practiced at a high level.

According to the results, providing proper supervision and guidance has received RII value of 0.52 and shows that it is practiced at a moderate level. Weekly process safety discussions also has received the same RII value and implies an average level of practice. Weekly process safety discussion provides a platform to communicate between people at various classes and sub-contractor. Hence, management of sub-contractor is remaining in poor level in Sri Lankan construction industry. Hence it could be identified a barrier to implement the SWC in Sri Lanka. RII value of weekly process safety discussion is 0.52. Similarly, daily tidying up after work (RII = 0.53) and final check after work ((RII = 0.50) can also be identified as SWC concepts with moderate level of application in Sri Lankan construction industry. The main reason of inadequate tidying up is due to the rush of delayed activities in the project. Therefore, it is difficult task to carry out cleaning until the end of work.

Hence, it is clear that the most of SWC related elements are practiced at very high to moderate level in Sri Lankan construction industry and only a very few elements are moderately practiced. Hence, a positive component influence for effective adoption of SWC concept in Sri Lankan construction industry can be seen.

6. FINDINGS OF EXPERT INTERVIEWS

The purpose of conducting expert interviews was to evaluate the suitability of SWC to Sri Lankan construction industry by identifying the benefits and barriers of implementation. Five experts from management positions were selected for expert interviews based on their knowledge and experience on the field as detailed out in Table 2.

All five respondents had a sound knowledge related to SWC concept. Some respondents had gained the knowledge and experience on SWC concept while they were involving in foreign projects and some of the respondents had gained the knowledge when they were working in foreign countries; especially in Japan, China, Hong Kong, Singapore and United Kingdom. Further, universal training openings have also helped some respondents to gain knowledge on SWC concept. All responded indicated that SWC is not currently practiced as a concept in the Sri Lankan construction industry, though the practices related to SWC are in use.

Table 2: Details of respondents

Respondent	Designation	Years of experience in the field
A	Safety Manger	25 years
B	Health, Safety and Environment (HSE) Manager	15 years
C	Health, Safety and Environment (HSE) Manager	20 years
D	Health and Safety (HS) Manager	18 years
E	Safety Manger	15 years

6.1 Benefits of implementing SWC

A list of benefits of implementing SWC could be identified though the literature survey and all the experts agreed with the identified benefits. Apart from that, a several new benefits could be added based on the expert survey findings. The identified benefits through this study are indicated in Table 3.

Table 3: Redefined benefits and barriers on SWC implementation

Benefits	Barriers
<ul style="list-style-type: none"> ▪ Reduced accident rates ▪ Increased safety training ▪ Stronger safety awareness and safety commitment ▪ Improved safety-related communication ▪ Establish safety habits of workers ▪ Identification of potential hazards ▪ Improve housekeeping practices within the construction site. 	<ul style="list-style-type: none"> ▪ Low literacy level of workers ▪ Poor safety attitude of workers ▪ High turnover rate of workers ▪ Limited budget, human resources and facilities on site safety ▪ Inadequate safety attitude of top managers ▪ Prevailing subcontracting practice ▪ Tight project schedule due to rush jobs ▪ Poor participation to SWC events ▪ Limited land area to carry out daily safety meetings and daily safety exercises ▪ Less awareness of the safety professionals on SWC

Improved safety awareness of workers is a perceived benefit which can be achieved after implementing of SWC. Five respondents, namely A, B, C, D and E strongly agree that SWC can promulgate safety awareness among the workers, who involve with the construction process. Respondent E believes that the execution of SWC could build safety awareness at frontline level and cultivate good safety culture at the administration level. Interviewees B, C and D further highlight that SWC would facilitate safety habits among the workers, thus, enhancing the site safety and neatness which will lessen potential accidents.

Identification of potential hazards is a significant benefit that can be achieved through SWC. Respondent A, B and C indicate that number of hazards can be easily recognized during hazards identification activity meeting. Further, respondent E highlight that reporting of unsafe condition is an easy way to take actions against identified unsafe conditions and it will also avoid the occurrence of occupational accidents. Both respondents A and B cite that SWC may encourage to improve the two way communication between site workers and site management. Respondent C further mentions that daily, weekly and monthly safety meetings and safety discussion are a good platform to the management and workers to communicate their opinions. Respondent D and E advocate that good communication is one of the significant factor to reduce accident rate.

6.2 Barriers to implement SWC

Barriers to implement SWC at Sri Lankan context, identified through the expert interviews are indicated in Table 3. Respondents B and D concur that tight work schedule of construction site is a major barrier affected to implement the SWC. Contractor requires to handover project to client within the agreed time period and avoids paying for additional cost due to unexpected delay. Hence, morning daily excesses, hazards identification activity, safety inspection not carried out due to tight schedules. Respondent A further opines that contractor relinquishes safety activities because of targeted profit. All respondents believe that important functions of SWC might be chucked to save time. Interviewee B has observed that some sub-contractors and labourers do not follow practices of SWC. B further adds that participation at safety meeting of sub-contractors is at a very low level. Respondent A highlights that daily safety meeting provide more details related to safety issues and corrective measures, hence, absence for safety meeting restricts the opportunity to obtain safety knowledge and it leads to accidents due to unawareness. All respondents state that participating safety meeting is significantly contributed to better safety culture.

Respondent A, B, C and E mention that lack of budget allocation of safety is another barrier to implement the SWC. Always parties who involved in construction project concerned about reduction of cost and profit maximization. Therefore, safety is evaded when following profit. Moreover, respondent E revealed that different work schedules affect the implementation of SWC, such as; all the workers do not start their work on the site at one time. Hence, that could disturb for smooth operation of SWC. Significant area is required to accommodate all the site staff in one place to carry out safety meetings and morning pre-work physical exercises. As Respondent A points out, limited site area could be a considerable challenge for proper execution of SWC. Respondents B and C further highlight that construction sites situated in Colombo area have to face a huge challenge due to the limited of land area. Further, findings reveale less knowledge and awareness of safety professionals on SWC is a also a barrier for its implementation. However, as the experts mention, though Sri Lankan construction community is not much aware of SWC as a concept, almost all the elements related to SWC are known by the safety professionals and therefore, it can be easily eliminated by providing a basic training on the concept.

6.3 Applicability of the SWC concept to Sri Lankan construction industry

All the expert interview respondents agree that implementation of safe working cycle is important and suitable for Sri Lankan context. According to them, SWC is an incentive programme, which basically improves discipline of employees on safety in construction and the uplift the individual safety behaviour, which will enable the construction projects/ organisations to improve their safety culture. However, as the experts revealed, SWC can be easily integrated with ISO 18001 standard, which is already practiced by most of the construction organizations in Sri Lanka. Further, according to the research findings, adding risk assessment and making awareness will add a more value to SWC. Further, adequate investment of financial resources is also important for effective application of SWC in construction industry in Sri Lanka.

Moreover, knowledge and experience obtained from foreign investment projects by experts are another significant aspects when considering the suitability of SWC concept to Sri Lankan construction industry. According to the respondent A, B and D, most of foreign investments are done by China and Korean nations in Sri Lanka and they are expanding day by day. Different countries have invested their money for mega projects to be carried out in Sri Lanka such as Port City, Altres Residents, Hyaat, World Capital Centre, etc. All the contractors of these projects are handled by world reputed construction firms who apply world acknowledged safety management tools in their construction projects. The experts can obtain more knowledge and experience regarding SWC concept from foreign investment projects. Hence, this is a good opportunity for Sri Lankan to start with SWC concept and hence to promote SWC concept among Sri Lankan construction industry. Thus, aforementioned facts provide sufficient evidences for the possibility of applying the SWC concept in Sri Lankan construction industry.

7. CONCLUSION

The research aimed at investigating the applicability of SWC concept for Sri Lankan construction industry. The research reveals that SWC is not currently practiced in Sri Lankan context as a concept, but industry is adopting many practices from SWC concept in an ad-hoc manner in varying degrees. The research looked into relative level of practice of each SWC related practice and identified that SWC related elements are practiced at a very high to moderate level. Among different SWC practices, morning safety meetings, hazard identification activity, monthly inspections, safety committee meetings, monthly safety meetings are practiced relatively at a high level in Sri Lankan construction industry. However, tidying up after work, guidance and supervision at work, weekly process safety discussion and final check after work are practiced relatively at a moderate level in Sri Lankan construction industry.

Findings from the expert interviews reveal that Sri Lankan construction community can obtain number of benefits out of implementation of SWC concept such as; reduced accident rates, increased safety training, stronger safety awareness and safety commitment, improved safety-related communication, establish safety habits of workers, identification of potential hazards and improve housekeeping practices within the construction site. However, several potential barriers to implement SWC concept in Sri Lankan context exist such as; low literacy level of workers, poor safety attitude of workers, high turnover rate of workers, limited budget, human resources and facilities on site safety, inadequate safety attitude of top managers, prevailing subcontracting practice, tight project schedule due to rush jobs, poor participation to SWC

events, limited land area to carry out daily safety meetings and daily safety exercises and less awareness of the safety professionals on SWC.

However, all expert interview respondents agree on the necessity and suitability of implementing SWC concept in Sri Lankan construction industry. It is revealed that effective implementation of SWC is capable of enhancing the safety behaviour of individuals who are involved in construction projects and thus, building a better safety culture, which will ultimately result in improved safety in construction industry in Sri Lanka.

8. ACKNOWLEDGEMENT

The authors wish to thank the Association of Commonwealth Universities, United Kingdom for providing financial support to participate and present this paper in the International Research Conference of University of Salford, Manchester, United Kingdom.

9. REFERENCES

- Ahamed, M.S.S., Nafeel, A.F.M., Rishath, A.A.M. and Dissanayake, P.B.G., 2013, Site safety of Sri Lankan building construction industry, Available from http://www.civil.mrt.ac.lk/conference/ICSECM_2011/SEC-11-76.pdf, [Accessed 15 March 2017].
- Ahasan, R., 2001, Legacy of implementing industrial health and safety in developing countries, *Journal of physiological anthropology and applied human science*, 20(6), 311-319.
- Alarcon, L. F., Diethelm, S. and Razuri, G., 2007, Evaluating the effectiveness of safety management practices and strategies in construction projects, *Safety, Quality and Environment*, 15, 271-281.
- Chan, A.P.C., Wong, F.K.W., Yam, M.C.H., Chan, D.W.M., Ng, J.W.S. and Tam, C.M., 2005, From attitude to culture – effect of safety climate on construction safety, *Research Monograph*, The Hong Kong Polytechnic University.
- Chan, D.W. and Choi, T.N., 2015, Critical analysis of the application of the safe working cycle (SWC) interview findings from Hong Kong, *Journal of facilities management*, 13(3), 244-265.
- Chan D.W. and Hung, H.T.W., 2013, Application of safe working cycle (SWC) in Hong Kong construction industry: Literature review and future research agenda, In: *Proceedings of The Second World Construction Symposium: Socio Economic Sustainability in Construction*, 14-15 June 2013, Colombo, Sri Lanka.
- Cheyne, A., Cox, S., Oliver, A. and Tomas, J.M., 1998, Modelling safety climate in the prediction of level of safety activity. *Work stress*, 12(3), 255-271.
- Choi, T.N., Chan, D.W. and Chan, A.P., 2012, Potential difficulties in applying the Pay for Safety Scheme (PFSS) in construction projects, *Accident Analysis & Prevention*, 48, 145-155.
- Creswell, J. W., 2009, *Research design: Qualitative, quantitative and mixed method approaches*, 3rd ed., Sage publications: California.
- Darshana, W.D., 2017, Improvement of health and safety in construction sites in Sri Lanka, *Engineer: Journal of the Institution of Engineers, Sri Lanka*, 50(1).
- Environment Transport and Works Bureau, 2002, *Implementation of site safety cycle and provision of welfare facilities for workers at construction sites*, Technical Circular (Works) No. 30/2002.
- Gangwar, M. and Goodrum, P.M., 2005, The effect of time on safety incentive programs in the US construction industry, *Construction Management and Economics*, 23(8), 851-859.
- Guo, H., Yu, Y. and Skitmore, M., 2017. Visualization technology-based construction safety management: A review. *Automation in Construction*, 73, 135-144.
- Halwatura, R.U. and Jayatunga, T.L., 2013. Health and safety aspects in building construction industry in Sri Lanka, Available from: <http://dl.lib.mrt.ac.lk/handle/123/9056>, [Accessed 15 March 2017].
- Health and Safety Commission, Great Britain, 1992, *Personal Protective Equipment at Work Regulations 1992*, Available from: <http://www.legislation.gov.uk/ukxi/1992/2966/introduction/made>, [Accessed 15 March 2017].
- Hinze, J. and Gambatese, J., 2003, Factors that influence safety performance of specialty contractors, *Journal of construction engineering and management*, 129(2), 159-164.

- Hinze, J. and Wilson, G., 2000, Moving toward a zero injury objective, *Journal of Construction Engineering and Management*, 126(5), 399-403.
- Kheni, N.A., 2008, *Impact of health and safety management on safety performance of small and medium-sized construction businesses in Ghana*, Doctoral dissertation, Loughborough University, Leicestershire, UK.
- Koehn, E.E., Kothari, R.K. and Pan, C.S., 1995, Safety in developing countries: professional and bureaucratic problems, *Journal of Construction Engineering and Management*, 121(3), 261-265.
- Lam, H., 2000, Implementation of safe working cycle in public works, *Symposium on Safe Working Cycle*, Occupational Safety & Health Council, Hong Kong.
- Leichtling, B., 1997, Keeping quality employees requires effort, creativity, *Wichita Business Journal*, 12(25), 11-12.
- Marhani, M.A., Adnan, H. and Ismail, F., 2013. OHSAS 18001: A pilot study of towards sustainable construction in Malaysia. *Procedia-Social and Behavioral Sciences*, 85, 51-60.
- Mayhew, C., 2000, *Occupational health and safety issues for young workers in the fast-food industry*, National occupational health and safety commission (NOHSC), Sydney.
- Nawi, M.N.M., Ibrahim, S.H., Affandi, R., Rosli, N.A. and Basri, F.M., 2017, Factor affecting safety performance construction industry, *International Review of Management and Marketing*, 6(8S), 280-285.
- Occupational Safety and Health Branch, Labour Department, Honk Kong, 2002, *Code of practice on safety management*, Labour Department, Honk Kong.
- Occupational Safety and Health Council (Hong Kong, China), 2002, *“Safe working cycle” handbook*, Hong Kong: Occupational Safety and Health Council.
- Ozaka, H., 2000, *Safe working cycle activities for preventing industrial accidents in construction*, Symposium on Safe Working Cycle, Occupational Safety & Health Council, Hong Kong.
- Priyadarshani, K., Karunasena, G. and Jayasuriya, S., 2013, Construction safety assessment framework for developing countries: a case study of Sri Lanka, *Journal of Construction in Developing Countries*, 18(1), 33-51.
- Rameezdeen, R., Pathirage, C. and Weerasooriya, S., 2003, Study of construction accidents in Sri Lanka, *Built-Environment-Sri Lanka*, 4(1), 27-32.
- Rubio, M.C., Menéndez, A., Rubio, J.C. and Martínez, G., 2005. Obligations and responsibilities of civil engineers for the prevention of labor risks: references to European regulations. *Journal of Professional Issues in Engineering Education and Practice*, 131(1), pp.70-75.
- The Real Estate Developers Association of Hong Kong and The Hong Kong Construction Association, 2005, *construction site safety handbook - safety partnering*, The Real Estate Developers Association of Hong Kong, Hong Kong, The Hong Kong Construction Association, Hong Kong.
- Toole, T.M., 2002, Construction site safety roles, *Journal of Construction Engineering and Management*, 128(3), 203-210.
- Tse, S.L., 2005, Study of the impact of site safety cycle on safety performance of contractors in Hong Kong, *Journal of Safety Research*, 16(2), 61-71.
- Vitharana, V.H.P., De Silva, G.H.M.J. and De Silva, S., 2015, Health hazards, risk and safety practices in construction sites—a review study, *Engineer: Journal of the Institution of Engineers, Sri Lanka*, 48(3)

CIRCULAR ECONOMY AND REAL ESTATE: ALTERNATIVES FOR OPERATIONAL LEASE

H.D. Ploeger*, M. Prins, A. Straub and R. van den Brink

*Faculty of Architecture and the Built Environment, Delft University of Technology,
Julianalaan 134, Delft , 2628 BL, The Netherlands*

*Email: h.d.ploeger@tudelft.nl

Abstract: The concept that suppliers retain ownership of building products and the materials encapsulated within these products and that their customers ‘only’ pay for services is a paradigm in Circular Economy. However in many legal systems, elements incorporated in a building such as the facade or the roof, or equipment in a plant, are seen as fixtures and therefore considered to be a part of real estate. Therefore ensuring multi-cyclic behaviour within the so-called technical loop of CE is not evident. At the moment the challenges of property law concerning CE, real estate and operational lease are hardly discussed within the literature. This paper explores the concept of service providing related to operational lease for real estate, with a focus on Dutch property law, illustrated by legal case studies. The paper ends with some conclusions that offer first guidelines for alternative implementations of the operational lease concept, taking into account the CE ambitions to reduce the extraction of the amount of raw materials.

Keywords: Circular Business Models, Operational Lease, Property Law, Real Estate, Service Providing

1. INTRODUCTION

In recent years, circular economy (CE), although in essence given its constituent concepts not a new idea, gained an enormous worldwide popularity as the new sustainability paradigm. This popularity of the idea of a transition from a linear to a circular economy might be explained by the accent on the economic rationale behind CE thinking. The basic elements are price increase on raw materials, combined with Stahels’ (1982, 2006) concept of service providing, together assumed to ensure materials’ multi-cycling behaviour (Mohammadi, Prins & Slob, 2015).

The concept that suppliers retain the ownership of building products or material, and provide the use under operational lease, is more or less advocated as a CE paradigm (EMF, 2013). However in many legal systems elements incorporated in the building, such as the facade or the roof, or equipment in a plant, will be considered to be fixtures and therefore by the rule of *accessio* owned by the land owner. Therefore ensuring multi-cyclic behaviour within the so-called technical loop might not be evident. In current construction industry literature these legal aspects and their implications in relation to CE have not been taken into consideration yet. In order to bridge this literature gap, this paper explores the concept of service providing related to operational lease for real estate, with a focus on Dutch property law, and will be illustrated by legal case studies.

The paper ends with conclusions that offer first guidelines for alternative implementations of the operational lease concept, taking into account the CE ambitions for reducing the extracting of the amount of raw materials.

2. CIRCULAR ECONOMY

2.1 The need for sustainability

In the 1970's, mainly under the influence of the reports and models of the Club of Rome published under the alarming title 'Limits to Growth' (Meadows et al., 1972) and the 1973 oil crisis, the topic of the finite available natural resources came high on the sustainability agenda. As a result, a movement started that advocated the use of less and cleaner materials, and reduced energy consumption. More recently, the idea that in sustainable production products are recycled has become particularly known for the book by Braungart and McDonough (2002) "remaking the way we make things". One may observe that even earlier authors like Stahel (1983) and Kristinsson et al (2001) followed this line of reasoning, nowadays known as the Cradle to Cradle (C2C) approach.

2.2 The concept of Circular Economy

Although the term has been used earlier, circular economy (CE) has been given a new boost by the reinterpretation in the so-called 'Butterfly Model' (figure 1) of the Ellen MacArthur Foundation (2013).

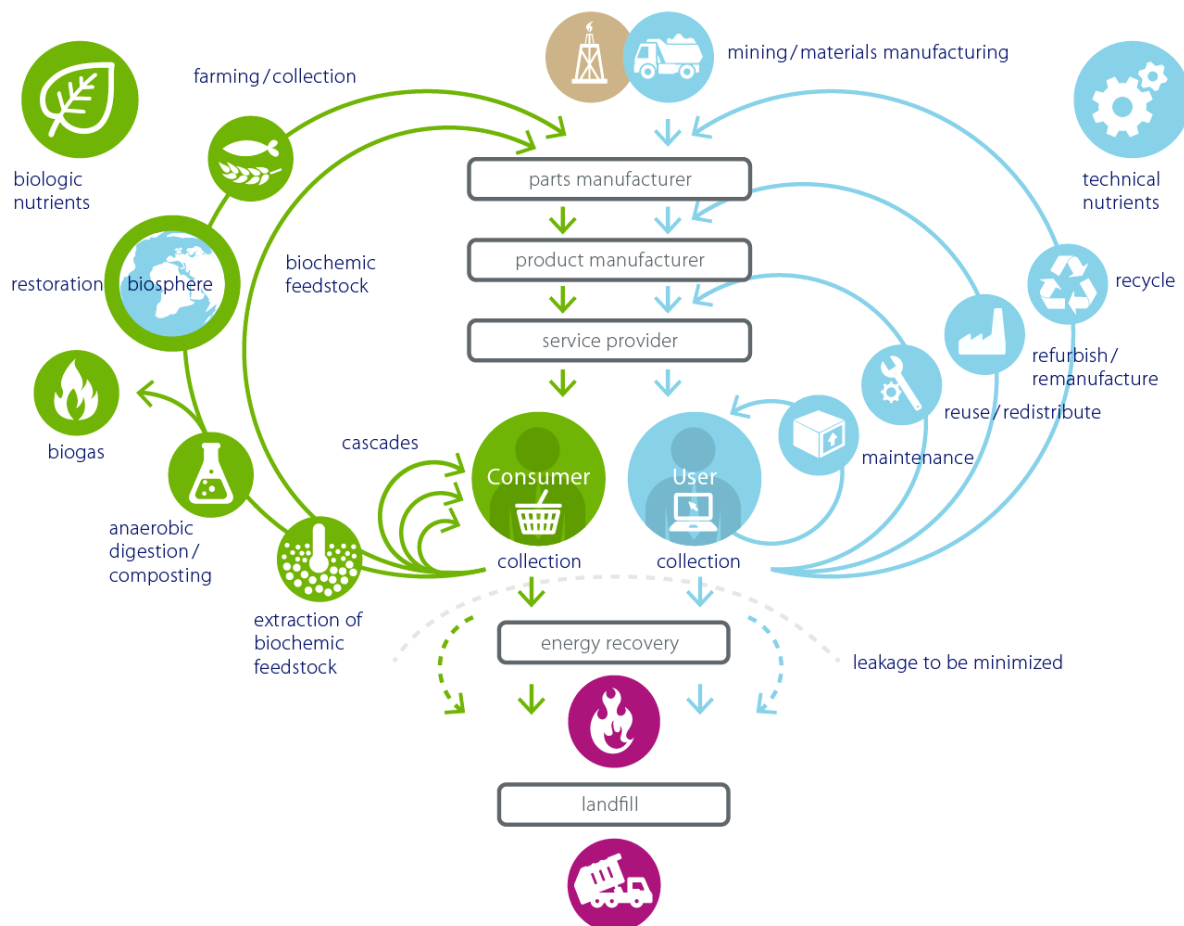

Figure 1: Model of CE (EMF 2013)

The Ellen MacArthur Foundation (2013) describes CE as:

“an economic and industrial system that is restorative and regenerative by design, and which aims to keep products, components and materials at their highest utility and value at all times, distinguishing between technical and biological cycles.”

An axiom within CE thinking is that use is made of renewable energy, such as sunlight, wind, waves and geothermal heat, as well as that this energy is available to a sufficient extent, and in that one respects general principles of sustainability like: no pollution, non-toxic, no child labor, etc. Another axiom is that prices of raw materials will increase, this due to the growth of the global population and the increase of wealth. The re-use of raw materials is therefore economically the most obvious solution. Essentially CE is based on the premise that we no longer produce waste and therefore only commodities are used that are regenerative within biological loops or will continuously ‘ride’ the so called technical loops. The biological loop relates to all those materials that can be considered to be regenerative within the ecological system. All other materials and products (commodities) are expected to continue to circulate (multi-cyclic behavior) in technical loops (Mohammadi et al., 2015).

2.3 C2C compared to CE

From a C2C perspective CE is often considered with a focus on re-cycling. However, any form of multi-cyclical resource conservation (secured by contracts or by the applied business model) meets CE standards, or will be preferable from the aim to avoid embodied (e.g. labor and energy) capital destruction. This solution could involve a product that can be reused as a whole, or a product of which all components can be reused, or recycled at materials level. In terms of CE a preferred solution does not exist; market parties will elaborate this for each specific case. We conclude that within CE not as much the possibility of reuse or recycling is decisive, but the business models of market players will make multi-cyclical behavior evident, thus being sustainable. More simply stated, raw material conservation leads to economic advantage (Prins, 2017).

2.4 Use instead of ownership

The economic perspective of CE is mainly defined in the concept of 'service providing' (EMF, 2013). This means that producers retain ownership rights of the materials in the products and that customers ‘only’ pay for services. This is supposed to benefit all involved and even the economy as a whole (EMF, 2013; Bastein et al., 2013). Therefore a major shift from the traditional, linear economic model is the functional use of a product is of importance and not the possession (ownership) of it (Ministry of Infrastructure and the Environment, 2015). The latter means in essence that the supplier keeps the ownership and clients pay for the services provided including use, monitoring and maintenance. Pay per use and operational lease are the most used examples of service providing. These types of disruptive thinking are already embraced by major firms like Philips,⁴ Mitsubishi Elevators,⁵ Alstom,⁶ Rolls Royce,⁷ Desso,⁸

⁴ <http://www.lighting.philips.com/main/company/about/sustainability/sustainable-lighting/circular-economy>

⁵ <http://www.mitsubishi-liften.nl/m-use/>

⁶ <http://www.alstom.com/innotrans2016/renew/>

⁷ <http://www.eco-business.com/news/why-the-circular-economy-is-big-business/>

⁸ <https://www.ellenmacarthurfoundation.org/case-studies/cradle-to-cradle-design-of-carpets>

Interface,⁹ Desko¹⁰ and others. Preserving the product in the form of multi-cyclical behavior is in fact directly beneficial for the producer due to the axiom behind CE of increasing resource prices (see 2.2). While consumers pay no more for expensive short supply of the product and the expensive, scarce materials it contains, but only for the purchase of the services required.

3. CHALLENGES FOR CIRCULAR ECONOMY IN BUILDING INDUSTRY

The wider use of CE inside the building industry is not unproblematic (Prins, 2017). Many parts of buildings and buildings as a whole, are in fact characterized by:

a. A relatively high initial investment, associated with a relatively long service life, so operational lease will result in a fast growing asset part at the balance sheet of suppliers and thus strongly and negatively affecting their solvability and liquidity (it has to be remarked the lessee has the advantage of a reverse situation maintaining his liquidity).

b. Being entirely or in part project-specific (custom-made one-off's), and belonging to a complex entity with different life spans of the constituting parts, so resulting in difficulties concerning as well demounting as all forms of re-using. Also often a high number of service providers is involved.

c. Irreversible technical degradation, limiting the possibilities for re-use.

d. Subject to regulatory requirements such as constructive safety rules and real estate law; limiting re-using building parts as well as possibilities for service providing (substitution risk). As described in short all these points from a CE perspective are specific challenges. This paper will elaborate upon the challenges posed by a very specific part of real estate law: the ownership of products and materials used in the buildings, related to the concept of operational lease. In the next section we will discuss the implication of the traditional ownership model, especially from the perspective of Dutch property law, being a species of the civil law system as applicable on the European continent.

4. TRADITIONAL OWNERSHIP MODEL OF REAL ESTATE

Financial and legal aspects of a circular economic model for construction are closely connected. Project financing has traditionally been collateralized by the real estate object itself, while the value of such an object can only be accurately estimated if all of its functional components remain part of it. To provide an example: the facade, when removed from its building object, will lose its functional value, while a building without a facade is incomplete and cannot be used. Therefore, it can no longer be valued as a finished and fully functional real estate property.

According to Book 5, Article 1 of the Dutch Civil Code (legal) ownership is “the most comprehensive property right that a person, the ‘owner’, can have in a thing”. Also, the owner of a thing is the owner of all its components (fixtures), as far as the law does not provide otherwise. The latter means that the law can allow for exceptions on this rule.

⁹ http://www.interface.com/EU/en-GB/about/index/Mission-Zero-en_GB

¹⁰ <http://www.circle-economy.com/the-desko-case-diving-into-its-circular-best-practice>

In this respect three concepts are relevant:

a. Dutch property law makes a distinction between *movables* and *immovables* (Book 3, Article 3 Dutch Civil Code). Decisive is the question if an object is destined to remain on its location permanently, regardless of whether it is technically possible to move it to another site. Also the subjective intention of the builder is irrelevant (Van Vliet, 2002). This was laid down by the Dutch supreme court in *Ontvanger/Rabobank Terneuzen-Axel* (Hoge Raad 31 oktober 1997, NJ 1998/97) ruled that a 'Portacabin' (prefabricated, container-like portable unit), was immovable ("real property") because the unit was seamlessly attached to the land and an existing building and connected to the infrastructure grid for water, gas and electricity.

b. Accession is a term that means that the owner of the land is the legal owner of all immovables built in or on it (Book 3, Article 4 and Book 5, Article 20 Dutch Civil Code). *The rule of accession*, as applied to real estate can be traced back to the maxim *superficies solo cedit* in Roman law, and this principle applies in legal systems based on Roman law, such as Dutch property law (Van Vliet, 2002). In short the ownership of everything that is built on or in land, follows the ownership of the land. As explained in e.g. the Roman *Institutes of Gaius* (2.73) this rule has two aspects. If Alex builds a house on his land using bricks and wood of Barbara, Alex, as being the owner of the land, by law becomes the owner of the house, regardless of the fact that the materials used to belong to Barbara. On the other hand, when Alex builds a house using his own materials on the land of Barbara, she becomes the owner of the house, despite the fact that the materials belonged to Alex. The result in both cases is that original owner of the materials cannot reclaim his/her ownership (Van der Walt & Sono, 2016).

Not only the (immovable) building is considered to be part of the land (Book 5, Article 20 Dutch Civil Code), but also fixtures are considered to be part of the building (Book 3, Article 4 Dutch Civil Code). The question if an object becomes a fixture of a building, will be decided according to Dutch civil law by two criteria:

1. First that the component cannot be physically removed without causing considerable damage to the main object or the attached component.
2. Secondly also without such an attachment a component can become a fixture. This as '*accessio*' will also take place if the component is a fixture according to general opinion. The Dutch Supreme court (*Depex/Bergel* Hoge Raad 15 november 1991, NJ 1993/316) provided two factors that are important for the latter test: a) the main object will considered to be functionally incomplete without the component or, b) the component is specially adapted to the main component. E.g. a curtain-wall facade would be covered by the second point, even if most current envelope systems are already engineered in such a way that they would not fall into the first point. Important to note is that the intentions of the parties involved are excluded from the legal consideration, as being subjective.

c. *Mortgage law* according to Book 3, Article 277 section 2 Dutch Civil Code (in addition to book 5 of the Dutch Civil Code), protects the right of the mortgagee (the funder) to hold as *security* everything which is part of a property (such as the building on the land, or the fixtures of the building). In the case of an interest payment or repayment default of the debtor, the bank is entitled to sell the mortgaged property in public by auction and to recover the secured debt-claim from the sale proceeds.

To sum up: everything which is fixed property on a piece of land owned by a specific party, by definition is part of the "real property" of that owner. The rule of *accessio* means that a supplier

can't claim ownership over, for example, a door. This because the door is a fixture of the house and therefore part of the property. Only in specific cases, as provided for by the law, Dutch property law allows exceptions to the rule of *accessio*. We will discuss this under section 5.

5. HOW TO SPLIT THE OWNERSHIP OF A BUILDING AND ITS CONSTITUENT PARTS

5.1 Motives for *accessio*

There are two motives for the rule of *accessio* (Van Vliet, 2002; Mes et al., 2016):

I. Legal security: for third parties legal ownership of objects would be hard to determine if it was based on parts.

II. Preservation of value: this presupposes that the sum of the parts together is worth more than all parts taken separately. Once different objects have been joined, the law should prevent the loss of the added value of the unity.

In other words: the purpose of property law is to offer legal security and to maximize and preserve real estate values in society.

The first motive could move in a different direction in the near future through the use of Building Information Modeling (BIM) and more standardized interfaces. This would mark components according to supplier (and eventually owner) through an ongoing BIM documentation of building components.¹¹ Also, or even more, the introduction of 'blockchain technologies' introducing radical different financing and ownership models of complex products and services might enhance this shift (Prins, 2017).

The second motive (preservation of value), seems fully valid under the principles of the traditional, linear economy. If a component of the building were to be removed, for example the stairs or the facade, the building would become unusable, leading to loss of economic value. On the other hand, after the removal also the component itself could be subject to a loss of value, because the component gets damaged or the component is specially adapted to the building. As worked out above under CE principles however it's just the fact that suppliers retain ownership rights (and therefore the right to remove and re-use the component and its materials) hence aiming for, if not preserving, value retention. Therefore, one may argue that CE practices based on the concept of service providing in terms of operational lease urges a radical change from the traditional ownership model on which property law has been based since Roman times (Mes et al., 2016). However, changes in fundamental rules of property law are not easy and can hardly be expected in the coming decades. Therefore we will concentrate on solutions based on the law as it stands now.

5.2 Case based exceptions to the rule of *accessio* concerning real estate

However, in specific cases Dutch property law allows for exceptions on the rule of *accessio*. That means, even when a component is considered to be a fixture of land, ownership of land and fixture can be separated.

¹¹ See also the recent 'Madaster' initiative: <https://madaster.com/>

The main exception is the establishment of a building lease (*opstalrecht*). This is a limited property right (a right in rem), which enables the lessee to have the ownership of buildings or constructions or plants (vegetation) in, on or above an immovable thing owned by someone else. Therefore, the building lease would allow for keeping ownership on the side of the manufacturer or a third party such as a service provider. However, the Civil Code puts some limits: the object of such an ownership, separated from the land, must be a building or a 'construction'. The exact meaning of the latter is not completely clear. But from literature and case law it can be concluded that in Dutch property law, only a component which has sufficient (economic) independence can be separated from the land or a building (Bartels & Van Velten, 2017). Common examples are radio towers, wind turbines, or utility pipelines. Also building leases are established for elevators and technical equipment in buildings. For this legal separation by use of a building lease, the value of the building has to be balanced against the value of the individual components of the building. Moreover, components can only be separated which do not downgrade the unity (this follows the general rule of accession concerning the 'unity and the subsequent' as also laid down in Book 5, Article 14 of the Dutch Civil Code, concerning 'moveable property'). The value of the unity, however, is again based on the public opinion.

To the best knowledge of the authors in Dutch real estate only one case of split ownership based on service delivery has been implemented in the Netherlands. Under the name of 'M-use' Mitsubishi Elevators Europe offers the possibility to the owner of a building to lease the elevator. At the moment a similar approach is under research for facades of buildings (Azcarate-Aguerre et al., 2017). But it appeared to be that highly specific contracts need to be laid out. These contracts must guarantee that the value of the property is safeguarded in case any of the collaborating parties needs to terminate or modify its involvement during the many years of the project's service-life. We will elaborate further on this in section 6.

Based on the case of Mitsubishi elevators, bankruptcy on either end of the service contract can be dealt with through traditional means: If the supplier files for bankruptcy, value is held not only by the physical asset (in this case the elevator), but also by the ongoing performance contract in which the asset is included. It is expected that the rights from the contract can be purchased and then be operated by another service provider (Azcarate-Aguerre et al., 2017). However, we must add that at this moment it is not clear if there will be a market for this kind of service contracts.

In the event of a client bankruptcy the nature of the asset limits the capacity of the service provider to simply claim it back without resulting in significant losses due to removal and reprocessing costs. In such a case the service contract could stipulate, for example, that the next owner of the building (if it is to be sold to repay the client's debt) must continue the service contract, or purchase the asset from the service provider in a traditional, linear procurement process. However, at the moment, mainly because of lack of case-law, there is uncertainty if this will work in practice.

Another approach can be found in the 1979 case of the Dutch Supreme Court, which would offer perspectives for a leasing scheme based on third-party legal ownership. In such cases an essential part of the construction would not be considered to be a component of it, in case a general opinion can be derived from the lease contracts. An example is the navigation system for ships in the *Radio Holland* case, Hoge Raad (Supreme Court) 16 March 1979, NJ 1980/600. In this case the question had to be answered if an electronic navigation system fitted in a ship was a fixture because it was crucial for operating the ship. At that time such a system was only

fabricated by a single supplier (Radio Holland), who held the de-facto market monopoly over this specific system, and who only distributed it under a leasing scheme. In this case the Dutch Supreme Court ruled that the fact that normally necessary equipment is *only* leased, and not transferred in ownership, might indicate that this equipment is not a fixture according to common opinion. In other words: the common opinion can be influenced by contractual standards.

It must be noted that in this specific case the market power of the supplier was enough to allow him, as a third party, to retain ownership of all such systems installed on clients' vessels. Such a case of concentrated supplier power is, however, difficult to imagine in the construction industry. On the other hand, this case law demonstrates that although if under Dutch property law a thing might be functionally incomplete without a certain component, this does not lead automatically to the conclusion that the component is legally a fixture.

6. ALTERNATIVE APPROACHES CONCERNING CE AND OPERATIONAL LEASE

6.1 Accessio and operational lease

As stated, according to Book 5, Article 1 of the Dutch Civil Code (legal) ownership is “the most comprehensive property right that a person, the ‘owner’, can have in a thing”. Also, based on the rule of *accessio* the owner of a thing is the owner of all its components (fixtures), as far as the law does not provide otherwise.

Except the M-use case, as discussed in section 5.2, and a Climate-KiC funded small scale pilot on four façade elements applied on a large university building of TUD (Azcárate-Aguerre et al., 2017), as far as known to the authors no real life cases exist in which operational lease in a CE context is applied for fixtures within the building industry.

The M-use example, seems to provide some, but rather complex, perspectives to implement CE in the building industry based on the concept of service providing. by establishment of a building lease for building components. Based on the Radio Holland case (section 5.3), it would be theoretically be possible to influence the the answer if a component is a fixture, by use of leasing contracts. However it might take long – and it is not really probable at the moment – within the construction industry before suppliers can establish a market monopoly leading for certain components not to be considered fixtures according to common opinion . Further, more specific contractual arrangements need to be established considering bankruptcy of either the client or the supplier. Considering collateral risk, operational lease therefore seems only possible for clients with a very high non-disputable credibility or otherwise in contracts in which revenue streams for funders one way or another are reduced in risk (Hieminga, 2015).

Therefore, from a legal point of view, our conclusion is that this leaves uncertainties and therefore does not offer a solid basis for development of a circular business model.

6.2 Economic ownership

Another approach might be the concept of ‘economic ownership’. This is not a notion in the Dutch Civil Code, but particularly relevant in fiscal law.

Economic ownership describes the situation where someone obtains the full enjoyment of the object, including bearing financial risk for it, while not being its legal owner. As mentioned above, economic ownership is a concept that has no fixed legal meaning in property law, but depends on the basis of the right of the user. Long-term leasing of real estate such as land or built objects on it is an example of such a situation; but economic ownership can also be based on a contract (e.g. a contract of sale). However, the success of the specific legal relationship depends on whether the economic owner can invoke his rights against third parties, such as a new legal owner of the property, or the mortgagee.

The right of removal is a right, which the economic owner can invoke against third parties. If the economic owner has the right to remove components which he placed in a construction or building, an economic separation will be composed between the construction or building and the applied object. The right of removal is therefore a way to avoid an unjust enrichment-action. Because of the right of removal applied objects can be removed at all times from the construction or building where it is placed in. If the right of removal would not exist, these objects would be applied by operation of law and thus would be entitled to the ground owner.

However the right of removal is legally limited to cases where the economic owner is also the user of the building (and land) itself, e.g. the holder of a ground lease or the tenant in case of renting (a part of) a building (Abas, 2007; Bartels & Van Velten 2017). Also therefore, the wider use of the concept of economic ownership to further promote the transition to CE by using operational lease within the building industry seems not to be so self evident.

6.3 Lease and pay per use of non – fixtures

It has to be noted that in the literature on implementing CE within the construction industry, series of examples exist of which those most often described for the Dutch market are already listed within section 2.4. The most well-known example might be Philips with its pay per lumen concept as first applied at the office of the Turntoo company. Others concern furniture (Ahrend, Desko), and carpet tiles (Interface and Desso). However, all these cases are from a property law perspective uncomplicated, because they concern non–fixtures. In other words, the rule of accessio does not apply.

Other examples often listed are from outside the building industry such as Alstom (trains) and Rolls Royce (aircraft engines). It has to be remarked these two latter examples are primarily based on specific business models which don't originate specifically out of CE thinking.

6.4 Recycling waste, Take Back and Buy Back as construction industry specific CE solutions

Recently the Dutch government claims that up to 90% construction waste will be recycled (Ministry of Infrastructure and the Environment, 2015). This estimation largely is based on the measurement methodology (kg's of waste) as well as the wide spread use of concrete waste as granulate for roadbuilding. To a lesser extend this is due to more recent innovations of the concrete industry to re-use concrete granulate for making new concrete elements and new bricks.

From a C2C perspective concerning the contribution of concrete this percentage is often discussed in terms of functional degradation and loss of embodied energy. From a CE perspective however, departing from the axioms as given in section 2, the re-use of concrete as granulate is compliant with the intended continuing multi-cycling behavior of materials. It's primarily the loss of Portland cement (of which larger percentages of what is used have to be re-mined for producing new concrete) and the loss of embedded value in terms of labor cost and energy (the latter as long as it is not clean nor cheap) which counts against this solution, making the CE business case behind less feasible (Prins, 2017).

Besides concrete this high recycling percentage mentioned above also is due to Dutch and partly EU based sometimes already rather dated waste regulations, sometimes also on since long existing more commercial models concerning for instance the treatment of plastics, metals, electronic waste and so on (Tukker et.al., 2016). The gypsum industry is another example, which although regulated now in the Netherlands, already organized itself assembling gypsum waste to make new gypsum with a 99% purity which is highly CE compliant. Rockwool assembling insulation waste and up-cycling it to Rockpanel is an example of a firm having set a rather optimal if not ideal CE standard, even before it was set.

At a component level more and more start-ups are entering the market often specialized to certain segments and working with internet based market platform's. Sometimes (for instance inner wall Metal-stud profiles) not that well known to larger groups of customers, sometimes (for instance second-hand wood planking and beams) even known to the wider public. A rather innovative concept is a Dutch startup acting as a broker in between demolishers on the one hand and architects and their clients on the other, this for all thinkable building components, trying to stimulate designers and their clients to think more CE wise, by considering buildings to be demolished as a stock of to be re-used materials and components. Recently also several –larger- Dutch municipalities are trying to explore this concept, also known as 'urban mining' on a regional level (Voet & Huele, 2016).

Examples of CE implemented to building projects as a whole are scarcer and a lot of attempts end up claiming being 'circular' as often closer reading of the 'promotional materials' resolves this circularity being limited to C2C.

This on the one hand has to do with the problem of procuring buildings although aiming to be CE based on split-ownership, in practice dealing foremost with just a main contractor as the tenderer. Often clients looking for CE solutions just ask tenderers for a vision on CE as precedents on alternatives still are lacking, as often is the knowledge of clients, as well as the industry, on how exactly to define a CE building. The state of the art in research attempts to define CE building passports (and related CE assessment methodologies) might be illustrative for this (Debacker & Manshoven, 2016). Reasonably one would expect the real property rules also are put forward within this context, but to the authors best knowledge up till now this is not the case.

Buy back contracts have got several forms varying from an obligation to buy back larger parts of a building at the end of the contract period by the different suppliers, in case the client likes to do as such (depending on assumed possible competing alternative offers) at that very moment, to an agreed residual value for taking back the building as a whole whether or not being translated into a shortage on the cost at the initial delivery of the building.

A remarkable example is the recently delivered building for the District Court of Amsterdam which has a contract period of five years after which the building had to be removed.¹² The architecture firm, an SME (Small and Medium Enterprise) delivering also engineering and contracting services, who won the tender, designed a rather traditional building which however can be easily de-mounted and re-mounted at another site. The residual value of the materials was translated into a reduction of the clients' investment. This example clearly shows that shortening the life span, as long as multi cyclic behavior is modelled, from a CE perspective doesn't necessarily reduce sustainability (Prins, 2017).

All well-known examples, which are extensively reported on (see section 6.3) within this context, concern non-fixtures (movable objects in buildings) or are not concerning real property.

7. CONCLUSIONS

In this paper we explored the challenges offered by of Dutch property law concerning CE, real estate and operational lease. As shortly addressed in section 3, only suppliers with high equity will be able to cope with the – financial – issue of balance stretch (growing amount of long term fixed assets) and for those delivering the more capital extensive parts of the building, the model might be questioned anyhow beyond the level of a few business cases (Prins, 2017).

Operational lease might be possible for rather specific – discrete – components, of which the functioning is heavily reliant on the service providing. Considering collateral risk, operational lease seems only possible for clients with a very high non-disputable credibility or otherwise in contracts in which revenue streams for funders one way or another are reduced in risk. Also economic ownership does not seem to be providing real opportunities to wider introduce the concept of CE service providing in the building industry at the moment.

On a larger scale of the building as a whole, buy back types of CE models have already appeared to be possible in the benefit of both suppliers and clients without being hindered by property law in case one tries to implement operational lease. However, in these cases real multi cyclic behaviour of materials behind a –reasonably to be expected – single loop is not guaranteed within the business cases. Section 6.4 illustrates that parts of the construction industry applying specific production procedures (Rockwool) or making sector wise innovations (gypsum sector, and concrete sector) are able to cope with the CE concept by applying all sorts of take back procedures mostly based on existing waste recycling models.

At the level of building components new start-ups are entering the market trying to implement CE thinking, of which a brokerage between demolishers and architects seems the most innovative at the moment.

It might be stated that the economic rationale for multi cycling behaviour of materials in case of operational lease might be economically seen more evident as in case of e.g. buy-back, but in fact there are also no formal guarantees built into this concept. As CE is assuming materials riding the loops based on economic evidence, one can question to what extent market parties, besides having a reasonable CE business model, have to be forced to act in their own benefit. Creating a CE as a societal regulated 'planned economy' seems an ideology, which is less

¹² <https://www.cepezed.nl/projects/170-tijdelijke-rechtbank-amsterdam>

favourable as the movement is most often considered to be nowadays. This even more in case operational lease would be treated as the one and only solution, resulting in a society with industrial have all's and consumers as the have not's.

8. REFERENCES

- Abas, P., 2007, *Bijzondere overeenkomsten: Huur*, Kluwer, Deventer.
- Azcárate-Aguerre, J.F., Klein, T. and Den Heijer, A., 2017, *Facade Leasing Upscaler Preparation Project*, Delft University of Technology, Delft.
- Bartels, S.E. and Van Velten, A.A., 2017, *Zakenrecht: Eigendom en beperkte rechten*, Kluwer, Deventer.
- Bastein, T., Roelofs, E., Rietveld, E., Hoogendoorn, A. (2013) *Opportunities for a circular economy in the Netherlands*. TNO, Delft.
(Retrieved from: <https://www.government.nl/documents/reports/2013/10/04/opportunities-for-a-circular-economy-in-the-netherlands>)
- Braungart, M., McDonough, W., 2002, *Cradle to Cradle, Remaking the way we make things*, North Point Press, New York.
- Debacker, W, Manshoven, S. eds., 2016, *Key barriers and opportunities for materials passports and reversible building design in the current system, Interim state of the art Buildings As Material Banks (BAMB) report. An EU H2020, project*: http://www.bamb2020.eu/wp-content/uploads/2016/03/D1_Synthesis-report-on-State-of-the-art_20161129_FINAL.pdf
- EMF, Ellen Mc Arthur Foundation, 2013, *Towards the Circular Economy*, <https://www.ellenmacarthurfoundation.org/assets/downloads/publications/Elle-MacArthur-Foundation-Towards-the-Circular-Economy-vol.1.pdf>
- Gray, K. and Gray, S.F., 2011, *Land Law*, Oxford University Press, Oxford.
- Hieminga G., 2015, *Rethinking finance in a circular economy; financial implications of circular business models* ING Economics Department. https://www.ing.nl/media/ING_EZB_Financing-the-Circular-Economy_tcm162-84762.pdf
- Kristinsson, J., Hendricks, C. F., Kowalczyk, T., & te Dorsthorst, B. J. H., 2001, *Reuse of secondary elements: Utopia or Reality*. In CIB World Building Congress: Performance in Product and Practice 2nd - 6th April 2001, Wellington, New Zealand. in-house publishing (Netherlands): CIB.
- Mes, A.J., Ploeger, H.D. & Janssen, B.A.M., 2016, Eigendom van onroerende zaken, met name natrekking: Flexibele eigendomsverhoudingen in het vastgoedrecht. in LCA Verstappen (ed.), *Boek 5 BW van de toekomst: Over vernieuwingen in het zakenrecht*. KNB Preadviezen, vol. 2016, SDU, Den Haag, pp. 145-217.
- Meadows, D.H., Meadows, D.L., Randers, J. Behrens, W.W. (1972) *The Limits to Growth. A Report for the Club of Rome's Project on the Predicament of Mankind*. Universe Books, New York. (Retrieved from: <http://www.clubofrome.org/report/the-limits-to-growth/>).
- Ministry of Infrastructure and the Environment, 2015, *Circular economy in the Dutch construction sector*, Rijkswaterstaat - National Institute for Public Health and the Environment, The Hague.
- Mohammadi, S., Prins, M., Slob N., 2015, Radical Circular Economy. In: Egbu, C. eds. *Going North for Sustainability: Leveraging knowledge and innovation for sustainable construction and development*, Proceedings of the CIB International Conference held at London South Bank University 23-25 November 2015, pp. 451- 461, IBEA Publications Ltd, London. (Retrieved from: (<http://repository.tudelft.nl/islandora/object/uuid:b80ad8fd-3ffc-48cf-a1b6-82554a3a9a3c?collection=research>))
- Prins, M., 2017, *Circulaire Economie; kansen en barrières voor het hergebruik van gebouwcomponenten*, in: Neele, H., Weelink, J.H., Welle R. van der, eds. Online publication Collectie Overheid – Omgevingswet, Module Afval. Wolters Kluwer, Deventer. FC in bewerking. pp. 1-10.
- Stahel, W.R., 1982, The Product Life Factor. In: Grinton, O.S. eds. *An inquiry into the nature of sustainable societies: The Role of the Private Sector*. Houston Area Research Center, Woodlands Texas.
- Stahel, W.R., 2006, *The Performance Economy*, Palgrave Macmillan Ltd, Basinstoke.
- Tukker, A, Bueren, E., Raak, R., Spork, C. (2016) *Towards a Circular Products Initiative in the EU, Report of the Leiden-Delft-Erasmus Centre for Sustainability*, Ministry of Infrastructure and The Environment (I&M), The Hague.
- Van der Voet, E., Huele R., 2016, *Prospecting the Urban Mine of Amsterdam*, AMS, Amsterdam. http://www.ams-amsterdam.com/wordpress/wp-content/uploads/2016/03/AMS_Project-Final-Reporting_PUMA1.pdf
- Van Vliet, L.P.W., 2002, Accession of Movables to Land: I, *Edinburgh Law Review*, Vol 6, p. 67-84.

Van der Walt, A.J. and Sono, N.L., 2016, The law regarding inaedificatio: A constitutional analysis, *Journal of Contemporary Roman-Dutch Law*, Vol. 79, p. 195-212.

CONTRACTUAL AND OWNERSHIP ASPECTS FOR BIM

P. Silius-Miettinen¹ and K. Kähkönen²

¹ *Tampellan Esplanadi 3 A 41, FI-33100, Tampere Finland*

² *Construction Management and Economics, Tampere University of Technology, P.O. Box 60, FI-33101, Tampere, Finland*

Email: pirjosm@gmail.com

Abstract. Building Information Modelling (BIM) and the resultant digital models are becoming gradually a commonplace practice in Finnish building profession through the large building companies. In spite of that the architects, building designers and civil engineering are developing their own models. The key challenge appears to be the lack of jurisprudence and contract models, which do not encompass the term BIM. The digital models of buildings are products based on creativity and their ownership is treated with the Copyright Act. The economical and moral rights belong to the constructor, developer or civil engineering. The contracts should be included with writing “BIM life cycle” special stipulations. This paper presents the proactive contracting for BIM based building construction. It seems that the proactive negotiation of contracts is providing interesting possibilities for the total BIM life cycle. The proactive negotiation of contracts can connect preventive jurisprudence and quality management. The proactive negotiation also uses contracts for risk downsizing and conflict prevention. The proposed amendments and contract modifications are as a necessity considered for having a main role for integrated BIM operations in the Finnish building profession. The BIM based operations are becoming gradually more common but most of all knowledge sharing and cooperation are needed between the parliamentarians and building professionals.

Keywords: Building Information Modelling (BIM), Proactive Contracting, Scope Of Copyright For BIM.

1. INTRODUCTION

Contracts are known as providing rights, responsibilities and remedies. Contractual terms, express and implied, have a tremendous impact on the outcome of transactions and relationships. Traditionally, the steps in providing legal care have resembled like those of medical care: diagnosis, treatment, and referral – all steps that happen after a client or a patient has a problem. Care has been reactive. When one gets sick, one seeks treatment. When one encounter a dispute, one turn to a lawyer. Business people often understand contracts as legal documents, designed by lawyers in order to protect firms against risks and prepare them for potential litigation in the worst case scenario. [Haapio, H. 2004; Haapio, H 2010(1); Nystén-Haarala, S. et al. 2010].

In this paper the proactive contracting refers to the proactive law in the context of corporate contracting. Contracting is a field where companies inevitably face legal issues of financial significance. Consequently it can be often be easy, even for experienced people, to get into the relating business and legal troubles. Contracts present themselves as tools that combine proactive law and business management: tools that help clients run their business more efficiently, with improved outcomes, balanced risk exposure, and fewer problems. Well thought-out contracting processes and documents – both online and offline – can prevent misaligned expectations and disappointments so that unnecessary disputes can be avoided. [Haapio, H. 2010(1)].

Building Information Modelling (BIM) technologies are moving from the worlds of architecture and engineering to the arenas of construction companies and other players in charge of construction operations. The characteristics of modern construction business, its projects and site operations are very challenging. In practice construction projects means complicated interplay of numerous partners and companies. The Implementation of BIM within Europe was initiated later than the USA but showed a faster and wider improvement within the industry especially in Finland. According to the Finnish ICT Barometer for all architects in Finland (2007), 93% of architects are using BIM in current projects with 33% of that usage at BIM level 3. In the same survey it was observed that nearly 60% of Finland's engineers are using BIM in both the public and private sectors. These values include the facts that the architects, building designers and civil engineering in Finland are developing their own models. The Finns still have a lack of jurisprudence and contract models, which do not encompass the term BIM. [Kiviniemi, M. et al. 2011, Bataw, A. et al. 2015]

This paper targets to present how judicial problems in the BIM based operations particularly concerning the ownership and contracting through BIM's life cycle. The digital models of buildings are products based on creativity and the ownership will with the Copyright Act handled. The economical and moral rights belong to the constructor, developer or civil engineering. The term BIM life cycle refers to the whole time span when such digital models are used in construction projects. It is shown how the proactive negotiation of contracts can connect preventive jurisprudence and quality management.

This paper's findings are based on literature surveys and an earlier study by Silius-Miettinen (2012). The study was done during year 2012 at the University of Eastern Finland. The results explain different possibilities licencing BIM models, and the lack of jurisprudence and building contract models. This paper presents how the proactive contracting can ensure Good-quality Contracts and is the need of Change Management for total life-cycle of BIM.

2. PROACTIVE CONTRACTING

In the business transactions subjects to the interest – as an example task allocation, price, payments, milestones, rights, responsibilities, and remedies – revolves around the underlying contract. Contractual terms, express and implied, have a tremendous impact on the outcome of transactions and relationships. Many have already invested in resources, tools and technologies that enable them to manage their contracts and contracting processes effectively. Others still need help in these areas. In a number of organizations, contracts could be used more effectively than they are used today, and contract failures could be prevented more often than is done today. Expensive contractual disputes endanger relationships and consume time and resources which could otherwise be used for productive work. [Haapio, H. 2010(1)]

New business models, such BIM as life-cycle contracting, challenge the narrow and static understanding of contracts with hard and precise terms. Contract documents often do not contain mechanisms for dealing with contingencies, or “soft” contract terms. Often contracting parties are seen as confrontational with opposing interests. Since this hard contracting model or hard approach to contracting emphasizes the opposing interests, it highlights the need of the parties to safeguard themselves against risks, with precise and unchanging hard terms. Long-term cooperation requires flexibility and emphasizes common interests and shared risks, instead of simply trying to assign the risks to the other party. Partnering and alliances are good

examples of a strong need to find common interests for both parties and where the processes of all the parties become closely intertwined [Nystén-Haarala,S. et al. 2010]

2.1 Preventive towards a proactive



Figure 1: Preventive Law and Proactive Law [source: Haapio, H. 2010(2)]

Proactive Law belongs to approaches born out of real-life needs to balance the prevailing legal logic (Fig. 1). It belongs to legal approaches, which emphasise the many-sided, varied, and interactive nature of human reality. In order to understand the general principles of proactive law, we need to identify the core principles of preventive law, as these principles create the foundation on which proactive law and Proactive Contracting is built. Edward Dauer has identified four core principles of preventive law [Dauer E. A. 1994; Pohjonen,S. 2010]

1. Predicting human behaviour: A legal solution, which anticipates and takes into account what people will do and by doing so, preventing litigation. This improves personal and business relationships, and constitutes an essential part of the preventive law.
2. Conflict management: Preventive law is drawing parallels from the medical context, illustrated by the fact that successful medical treatment is prophylactic.
3. Embracement of risks: Instead of focusing solely on reducing one or a few elements of risks to zero, the preventive law approach focuses on the overall sum of risks and strives to reduce the overall risk.
4. Preventive legal service: Lawyers and in-house counsels must participate with others in multi-disciplinary teams in the planning of the business' venture. By bringing in legal expertise earlier, it becomes possible to detect and prevent legal problems from occurring.

While the primary target group of the preventive law message is lawyers – lawyers practicing preventive law – the proactive law message is targeted at both lawyers and clients, and the clients' buy-in is crucial. Proactive law seeks a new approach to legal issues in businesses and societies. Instead of perceiving law as a constraint that companies and people in general need to comply with, proactive law considers law as an instrument that can create success and foster sustainable relationships, which in the end carries the potential to increase value for companies, individuals, and societies in general. [Berger-Walliser, G et al. 2012; Haapio, H. 2010(2)]

The approach specifically called Proactive Law emerged in Finland, and its source was Proactive Contracting in business contexts. The proactive law movement encompasses the basic principles of preventive law stated above, namely preventing what is not desirable, and keeping problems and risks from materializing. Thus, as proactive law consists of preventive law, the characteristics above constitute the foundation of proactive law. The word proactive is the opposite of reactive, meaning that the approach to law is based on an ex ante view rather than an ex post view. The proactive law approach challenges the traditional backwards and failure oriented approach to law by acting in anticipation of legal disputes, taking control of potential problems, providing solutions, and self-initiation, instead of reacting to failures and shortcomings. [Berger-Walliser, G et al. 2012; Pohjonen, S. 2010]

2.2 Proactive contractor as legal architect

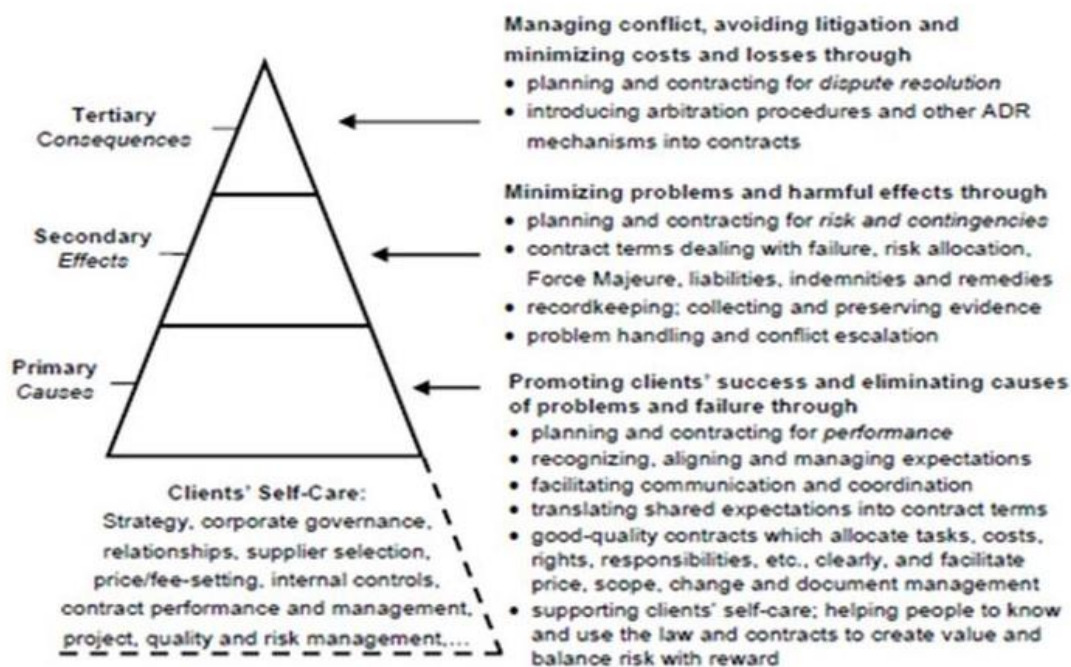

Figure 2: Proactive Contracting – Levels of Legal Care [source: Haapio, H. 2010(1)]

Finnish International Contract Counsel Mrs Helena Haapio has developed a model which is built on the use of contracts as proactive law tools (Fig. 2). This is about the conscious use of contracts and contracting processes as management tools which guide and support the success of the client's business, as Mrs Haapio has taught. Proactive legal care are divided into primary, secondary, and tertiary care, with clients' self-care as the foundation, as the figure two's pyramid adapted from preventive medicine is used to illustrate the different levels. Idea is not only to prevent ill-health but to promote wellbeing. A similar illustration can be used in the context of corporate contracting, where the primary goals are: first, to promote successful performance and relationships and to eliminate causes of potential problems; second, to minimize the risk, problems and harmful effects when problems do arise; and third, to manage conflict, avoid litigation and minimize costs and losses where they are unavoidable. [Haapio, H. 2010(1)&(2)]

In Proactive Law, the focus is in the development of understandings, structures, rules and procedures that ex ante enable the creation and achievement of desired goals and the avoidance of unnecessary problems (future-orientation). Proactivity differs from reactivity in that it emphasises consideration of how one can oneself create the preconditions for achieving goals in a manner that does not contribute to unnecessary problems. It is not therefore about simply reacting to something that has happened or is happening. It is about self-reflection and responsibility. In Proactive Law, the effort to create systems in which targets may be achieved in particular context is taken seriously. This means that the system is understood as a whole within which the setting of goals, the solving of conflicts and achieving or enforcing goals are all interactive parts of that whole. There is a need for much new understanding of realities outside the law in which goals are sought and reached for, and where the influential factors in this process appear. [Pohjonen, S. 2010].

Proactive lawyers can work as the Legal Architects, who principally add value and contribute to the company's bottom line. The Legal Architect's success in business transactions and relationships requires a systematic approach to contracting, informed advance choices, and strong contracting skills. A proactive lawyer working as the Legal Architect can aid in various ways, for example as a business partner, business designer, trusted counsellor, mentor, and coach. Taking a proactive approach as the Legal Architect and team player makes the practice of law in the corporate setting more effective and more satisfying, for both the client and the lawyer. Proactive Law challenges traditional notions of the law that rely upon a failure-oriented approach. Being a continuous learner, using legal skills to design and implement new creative solutions, and working for the common good give a feeling of being of valuable service to others – of making a difference, and building a better future. [Haapio, H. 2010 (1)&(2)].

The objective of the Legal Architect as Proactive Contractor is to avoid getting to that stage of dispute, through careful attention to legal clarity, early warning mechanisms, and enhanced collaboration between business partners; or in the case of proactive regulation, comprehensible, accessible, and enforceable legislation to facilitate understanding and ultimately, compliance with the law. The Legal Architect seeks to create win-win relationships. The Legal Architect as a Proactive Contractor takes into account the interests of all stakeholders involved to reach common goals instead of favouring or protecting one-sided interests. Therefore cross-professional collaboration between lawyers, managers and subject matter experts is crucial to reach common goals and to avoid problems and legal disputes. Proactive Law suggests a paradigm shift in the content-orientation of private and public regulation as it seeks to install a more proactive stance towards problem-solving. [Berger-Walliser, G et al. 2014].

3. SCOPE OF COPYRIGHT FOR BIM

Technology was first introduced into the industry in the early 1980s under the Virtual Building concept by Graphisoft's ArchiCAD now known as ArchiCAD. This was the start of the software revolution that allowed architects to create virtual, three dimensional (3D) designs of their project instead of the standard two dimensional (2D). Since then, new technologies and updated software were developed and used. However, this use of technology was only limited to the design stage, until the concept of Building Information Modelling (BIM) was introduced. The use of BIM is aimed for much more than just performing a model to see what the building should look like; BIM intend to create a model that contains all kinds of information, from spaces and geometry, to costs, personnel, programming, quantities, specifications, suppliers and other information types. [Bataw, A. et al. 2015]

Next BIM is to be viewed as the inhabited building model. “What is building?” is the question that comes to mind upon defining the BIM sector. The term "building" includes habitable structures like residences and office buildings and also covers structures that are used by people, but not inhabited, such as churches, gazebos and pergolas. A "building" is defined by some architectural dictionaries as "a structure of some elaboration, especially, in architectural usage, a dwelling house, hall for meeting, place of worship, or the like." A legal definition for copyright purposes of the word "building" should include all three-dimensional structures that are fixed at a certain site. In countries where architectural works are protected, generally the architect, who created the plans, is considered the author of both the plans and the structure. The builder of the work, on the other hand, is viewed as part of the process of producing the structure. An international committee, evaluating the appropriate protection of architectural works, suggested that the architect must be considered the author [Pollock, A.S. 1991]

3.1 Copyright law's aspects

Finland's Copyright Act is based on EU legislation. A person who has created a literary or artistic work shall have copyright therein, whether it be a fictional or descriptive representation in writing or speech, a musical or dramatic work, a cinematographic work, a photographic work or other work of fine art, a product of architecture, artistic handicraft, industrial art, or expressed in some other manner. Within the limitations imposed hereinafter, copyright shall provide the exclusive right to control a work by reproducing it and by making it available to the public, in the original form or in an altered form, in translation or in adaptation, in another literary or artistic form, or by any other technique. Copyright shall provide the exclusive right to control a work by reproducing it and by making it available to the public, in the original form or in an altered form, in translation or in adaptation, in another literary or artistic form, or by any other technique. When copies of a work are made or when the work is made available to the public in whole or in part, the name of the author shall be stated in a manner required by proper usage. [Finnish Copyright Act (404/1961) Section 1-3].

For comparison here is looked at the Copyrights in USA. An original design of a building created in any tangible medium of expression, including a constructed building or architectural plans, models, or drawings, is subject to copyright protection as an “architectural work” under section 102 of the Copyright Act (title 17 of the United States Code), as amended on December 1, 1990. Protection extends to the overall form as well as the arrangement and composition of spaces and elements in the design but does not include individual standard features or design elements that are functionally required. “Creation” is the first-ever tangible fixation or embodiment of a design, whether in plans, drawings, models, or a constructed building. “Publication” occurs when underlying plans, drawings, or other copies of the building design are distributed or made available to the public by sale or other transfer of ownership or by rental, lease, or lending. Construction of a building does not constitute publication for purposes of registration, unless multiple copies are constructed. [Circular 41, 2012]

3.2 BIM facing copyright law

Building information model is the result of creative work and an examination of the data model is based on the ownership of intellectual property rights (IPR). IPR refers to patents, utility models, copyright, trademark, integrated circuit layout-designs, designs, plant variety

protection and rights relating to the indication of origin of the goods. Intellectual property rights protect your inventions, works, pictorial or verbal brands and models in various formats. As a result of creative work generated intellectual property law, which gives the author control over the result. These intangible assets used in economic activity. The intellectual property rights are intangible exclusive rights to help safeguard the economic exploitation of the results of intellectual work. An intangible exclusive right means that only the holder of the right or with his permission shall be entitled, for example, to use a patented invention, to publish an edition of the book, to label their products under the trade mark or to continue the development of the data model without the owner's permission.

A survey was carried out in Finland which addresses judicial problems in the BIM based operations [Silius-Miettinen, P. 2012]. The main interest in this study was concerned the ownership and contracting through BIM's life cycle. The study's first result was that the BIM data model must be truly original, in order to copyright the exclusive right, to ensure the determination of the data model. However, the BIM entrepreneur should be aware that intellectual property rights affect the companies' activities, regardless of whether it is protected the company's own operations actively or passively. There is always at least to consider other exploited exclusive rights. The Intellectual property right of injunction nature, which causes the unintentional violation of rights of another operation, may be stopped for a shorter or longer period of time. Cooperation between the companies will also require that the exclusive rights to use the rights to be contracted.

The creator of an original BIM model, i.e. the architect, maintains both the ownership rights of the file itself and the copyrights. With respect to the former right, when utilizing BIM on a construction project to maximize efficiency of the project, many parties collaborate using this three-dimensional building program, such as architects, engineers, and consultants. Collaboration is fuelled by the creation of a central file location, e.g. the architecture firm's server (the electronic data/document management systems, called project bank in Finnish survey) Subsequently, the architect can assign users to the file. The users are limited to modify certain drawings and/or components.

For example, a mechanical engineer, i.e. a user, will be granted access to the central file but will be limited to manipulating only the mechanical, electrical, and plumbing objects and families in the master file; while a structural engineer will only be allowed to add and manipulate structural elements and families such as beams and columns. Such collaboration among different parties using such a computer program creates multiple owners of the drawings. The identification of parties, such as structural and mechanical engineers that will work on the BIM model and collaborate with the architect, is difficult. Many times parties such as specialized consultants (e.g. lighting consultants), are added later in the project at a point in time past the initial contracting stage; therefore, assigning ownership of the BIM model before the project commences adds additional difficulty. The American Institute of Architects (AIA) released E202-2008, Building Information Modelling Protocol Exhibit, which assigns authorship of each model element by project phase. [Branka, C. 2011]

The Finnish study showed that the copyright holder may grant a fee or royalty, for as an example, the development of the different parts of the license or the license data model. The contract may include temporal, regional or other restrictive conditions. In the services offered project bank data recorder model builder, when they contracted data model intellectual property rights, also worry about access to a data format. Parallel rights may also allow the business data model for sharing between the client and the service provider. The client may also sell the data

model intellectual property rights, in whole or in part, the designer or vice versa or entirely cross. Transfer of copyright in connection with the business of this study is well justified by. The legal ownership chaining data model able to turn contractually to handle the licensing requirement. However, contracts may be agreed by means of information modelling in all the different phases of the rights. Flexible agreements responsibilities and obligations as well as charges and selling encounter operationally proportionate to the size of the data model and the construction lifecycle.

The Finnish study showed also very clearly the lack of jurisprudence and building contract models without BIM stipulations. Construction industry in Finland has difficulties to change. As an example Singapore Building Control Act 1999 Act 22 [Act 22 of 2012 wef 01/12/2012] adjust the building plans consisting "drawings, details, diagrams, digital representations generated from building information modelling, structural details and calculations showing or relating to the building works". Similar legislation is the target also for EU legislation, on which the Finnish Building Act is based. Also Finnish building legislation needs the Approved documents and compliance for Building processes. Nearly all Finnish building professionals are clients of Building Information Ltd. The company publishes instructions for building and property management, regulations, contract documents and forms and product information. The construction project bank (the electronic data/document management systems) with BIM could also be possibly a good starting point for writing a proactive contract before the start of the construction works and to support the idea of the EU Commission's Green Paper 2014 for one building service contract.

4. BIM AS AN OBJECT FOR PROACTIVE CONTRACTING

Building Information Modelling and the results of digital models are becoming gradually a commonplace practice in Finnish building profession trough the large building companies, such as Skanska and YIT corporations. Nevertheless challenges in using BIM still exist. The BIM practices are still fairly technology oriented although our focus is on the combination of different models. The architects, building designers and civil engineering are developing their own models (Fig. 3).

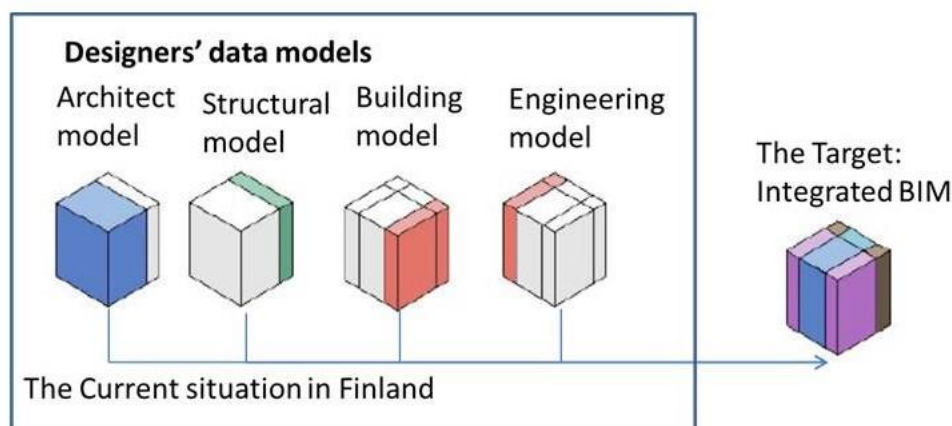

Figure 3: The current BIM situation in Finland

In designing an addition to a building or a renovation for a building, the original building plans are essential. The original building plans are not only necessary for scale, style, and dimension, but current building plans are necessary in order for the local building commissioner to approve

the building addition, as building specifications need be met to ensure aesthetic conformity, code compliance, etc. Right now, regeneration of building drawings for purposes of a building addition or renovation is considered copyright infringement and, thus, project prohibitive. Advanced drafting programs, such as BIM, exacerbates and complicates the issue by regeneration through a new medium, and a medium in which alternative designs can be easily displayed, thereby creating derivative works. [Branka, C. 2011]

Contracting is a process of the market-based exchange of privately held legal rights and goods (Fig. 4). Contracts and contracting are private economic activities and thus a subject of economists and business scholars. As it lies at the intersection of legal rights and economics, it often captures the interests of the economists and legal scholars who study the interaction of law, economics and institutions. Famous works by Coase highlighted the presence of transaction costs, i.e. the costs of monitoring and enforcing contracts, in addition to production costs. He argued that efficient market exchange can be hindered by the presence of transaction costs and the role of institutions is to reduce them. Coase also identified firms, the market and law as alternative institutions and modes of coordination for minimizing transaction costs and this observation opened the way for new institutional economics. [Coase, R. 1988; Nystén-Haarala, S. et al. 2010]

In civil law, the ideal law is to be the same for everybody and an object of interpretations separated from politics. When the law is seen as a continually-developing process of understanding, both the reactive and proactive ability and sensitivity of the system are increased. Consequently, the law system becomes more self-reflexive. Processes of change are often slow and gradual. Traditionally, ideal laws and contracts have been viewed as final. Their task is to bring clarity and stability and even though it is known and understood that circumstances and understandings change, laws and contracts are not usually constructed to be responsive to change in a considered manner. Even though it is known that changes will come, systems are not prepared for them in a proactive way. In contracting practice, change management is receiving an increasing degree of attention. Clarity of goals and in the rules invented to realise them supports the achievement of those goals. This demands dialogue and creativity. The logic of our present law is not suited to all of the tasks given to it, and all of the targets that have been set cannot be reached by employing legal logic and legal tools. [Haapio, H. 2010(1)]

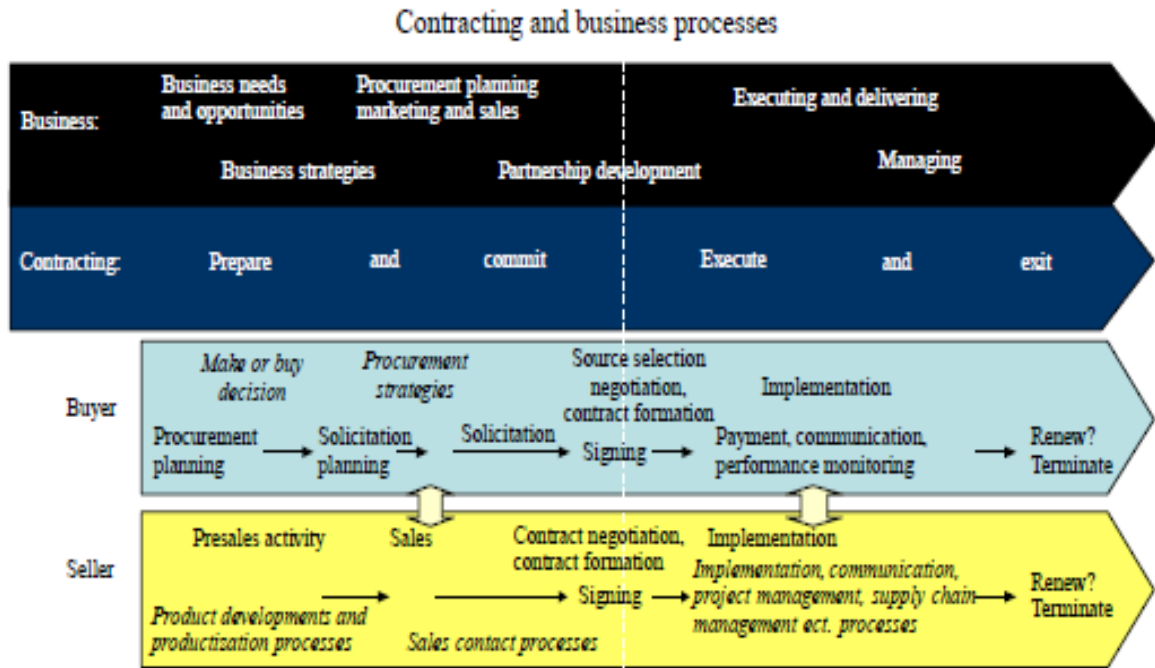

Figure 4: Contracting and business processes [Nystén-Haarala, S. et al. 2010]

4.1 Good-quality contracts

Contract quality can be viewed from many different angles, including content, presentation, process, and outcomes. Defining desired outcomes, allocating and communicating the parties' roles and responsibilities clearly, and providing incentives for the parties to fulfil their responsibilities then become key characteristics of good-quality contracts. Additional aspects of good-quality contracts are that they contain unambiguous requirements, divide costs, tasks, and risks clearly and fairly, provide for predictable outcomes and effective contract administration, and allow flexibility where needed. Proactive Contracting seeks to merge the different good-quality criteria of contracts. Having seen occasions when things went wrong, lawyers typically consider silence in contracts as risky and dangerous; gaps in contracts can cause unexpected costs and liability exposure. Gaps may relate to the core of the deal, for example scope, time or terms of delivery or payment, or to issues such as liabilities and remedies. [Haapio, H. 2010(1)].

Good-quality contracts build on proper planning and careful communication, ensuring a true and shared understanding of the business arrangement and the parties' goals. The good-quality contracts are the main goal of Proactive Contracting. Good-quality contracts can be characterised as entities that i) produce what they are expected to produce, ii) provide with the involved individuals the needed information for performing their work, iii) ensure that plans and actions are based on express knowledge (rather than vague or implied, "invisible" terms), and iv) provide a readable roadmap of how to proceed. [Haapio, H. 2010(1)].

Proactive Contracting facilitates informed decisions that lead to increased legal certainty and a reduction in overall risk exposure. With the inhabited building BIM working together, proactive lawyers and their clients can put in place tools, systems and training that help secure sound contract crafting – both online and off-line – and successful contract performance.

Proactive law then translates into everyday actions, helping clients to take better care of their deals and relationships. Change management included into BIM Contracts with different BIM status will lead to continually maintained Good-quality Contracts.

5. CONCLUSIONS

This paper is addressing how proactive contracting can help in negotiating contract with BIM. The proactive negotiation also uses contracts for risk downsizing and conflict prevention. Good-quality contract are the target for Proactive Contracting. Avoiding legal problems is an important aspect of proactive law. However, helping clients to achieve their objectives and promoting business success are even more important. Proactive law aims at joining the forces of lawyers and business people in an effort to not only stay out of legal trouble but also to take full advantage of the opportunities the law and contracts provide. The proactive negotiation of contracts can connect preventive jurisprudence and quality management.

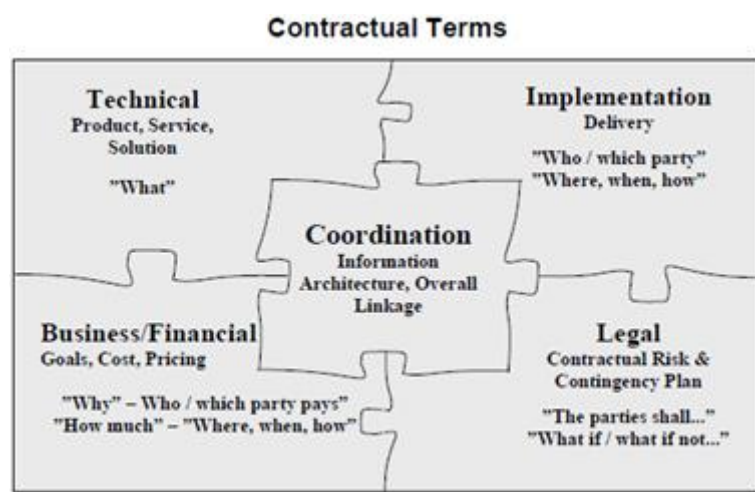

Figure 5: Contractual Terms – Puzzle Analogy. [Haapio, H. 2010(1)]

The legal component is just a one piece of the puzzle, albeit a quite important one (Fig. 5). Contracting success requires much more than legal knowledge and skills alone. Managerial and technical skills come to the fore, not only at the implementation stage but also when contracts are planned and put together. The input of managers and engineers with intimate knowledge of the relevant businesses and technologies as well as of the management challenges involved in such exchanges is needed in key areas in order to lay the foundation for the deal and construct operationally efficient contract term. But the wrong sort of flexibility in a contract may lead to higher costs and frustration; the right sort of flexibility may enable better commercial relationships. The goal is to find ways to enhance positive flexibility, without introducing disruption and potentially extortionate renegotiation of contract terms. [Haapio, H. 2010(1); Nystén-Haarala, S. et al. 2015]

BIM technologies are gradually moving towards the field of construction operations and site processes. Therefore it is getting more and more important to have a close look at the needs of key parties and professionals. As an example, in the future, the building information modelling contracts would also need to ensure that the construction of the data model version is saved in the electronic data/document management systems (EDMS) to manage the concatenation of the data model of exclusive rights. In the same way the construction contracts should be stored in the project EDMS, so that all parties have an equal opportunity to check their own starting

positions in proactive contract law. The used EDMS solution should be accessible also to those in charge of contract preparation e.g Legal Architects. Different versions of the designs are completed, stored as individual or combined models in the project EDMS and checked by the inspection program. The agreement provides for the merger and who amendment makes the data model.

6. REFERENCES

- Bataw, A. and Kirkham, R. 2015. Making BIM a realistic paradigm rather than just another fad. School of Mechanical, Aerospace and Civil Engineering. The University of Manchester. UK.
- Berger-Walliser, G. and Østergaard, K. 2012. Proactive Law – in a Business Environment. ed. Tilst, DJØF Publishing, Jurist- og Økonomforbundets Forlag, Copenhagen, Denmark
- Berger-Walliser, G. and Shrivastava, P. 2014. Georgetown Journal of International Law. Washington, USA. Available at: https://www.researchgate.net/profile/Gerlinde_Berger-Walliser/publication/273440662_The_Past_and_Future_of_Proactive_Law_An_Overview_of_the_Proactive_Law_Movement/links/5500b18b0cf2aee14b57326f/The-Past-and-Future-of-Proactive-Law-An-Overview-of-the-Proactive-Law-Movement.pdf [referred to 25.3.2017]
- Branka, C. 2011. The Drawings is mine! The Challenges of Copyright protection in the Architectural world. Journal of Law, Technology & Policy, Val. 2011, The University of Illinois, USA
- Building Control Act. 1999. The Statues of The Republic of Singapore. Informal Consolidation – version in force from 28/10/2013
- Circular 41, 2012. Copyright Claims in Architectural Works. U. S. Copyright Office, Library of Congress, Washington, USA
- Coase, R. 1988. The Firm, the Market and the Law, The University of Chicago Press, Chicago, USA
- Dauer E. A. 1994. Four Principles for a Theory of Preventive Law. McGraw-Hill, New York, USA
- Finnish Copyright Act (404/1961, amendments up to 608/2015)
- Haapio, H. 2010(1). Business Success and Problem Prevention through Proactive Contracting, Scandinavian Studies in Law Volume 49: A Proactive Approach. Edited by Peter Wahlgren. Published under the auspices of The Stockholm University Law Faculty, Stockholm Institute for Scandinavian Law, Stockholm, Sweden.
- Haapio, H. 2010(2). Introduction to Proactive Law: A Business Lawyer's View, Scandinavian Studies in Law Volume 49: A Proactive Approach. Edited by Peter Wahlgren. Published under the auspices of The Stockholm University Law Faculty, Stockholm Institute for Scandinavian Law, Stockholm, Sweden.
- Haapio, H. 2004. Contracts and lawyers – friends of the project: proactive contracting for project success. National Contract Management Association, Ashburn, Virginia, USA
- Kiviniemi, M. and Sulankivi, K. and Kähkönen, K. and Mäkelä, T. and Merivirta, M-L. 2011. BIM-based Safety Management and Communication for Building Construction. VTT research notes 2597. VTT Technical Research Centre of Finland, Helsinki, Finland.
- Nystén-Haarala, S. and Lee N. and Lehto, J.2010. Flexibility in contracts terms and contracting processes. International Journal of Managing Projects in Business Vol. 3 No. 3, 2010 pp. 462-478. Emerald Group Publishing Limited, Bingley, UK
- Nystén-Haarala, S. and Barton T.D. and Kujala, J (eds.). 2015. Flexibility in Contracting, A Special Issue of the Lapland Law Review 2015, Issue 2, Rovaniemi, Finland
- Pohjonen, S. 2010. Proactive Law in the Field of Law. financed by the Academy of Finland. Stockholm Institute for Scandinavian Law, Sweden
- Pollock, A.S. 1991. The Architectural Works Copyright Protection Act: Analysis of Probable Ramifications and Arising Issues, 70 Neb. L. Rev. (1991) Available at: <http://digitalcommons.unl.edu/nlr/vol70/iss4/5> [referred to 25.3.2017]
- Silius-Miettinen, P. 2012. Consideration for Acquisition and Proactive Contracting. MASc Civil Law Study wrote in Finnish, The University of Eastern Finland, Joensuu, Finland.

FINDING THE RIGHT INCENTIVES; CIRCULAR BUSINESS MODELS FOR THE CONSTRUCTION INDUSTRY

R. van den Brink, M. Prins*, A. Straub and H.D. Ploeger

Faculty of Architecture and the Built Environment, Delft University of Technology, Julianalaan 134, Delft , 2628 BL, The Netherlands

*Email: m.prins@tudelft.nl

Abstract: After its launch, the circular economy gained popularity all over the world as the new sustainability paradigm. Despite its popularity there is little to no material to be found on the implementation of the circular economy in the construction industry. Through a mixed method methodology using literature reviews, case studies, thought exercises, and interviews to both build and subsequently validate theory, five circular business models for service providing in the construction industry were developed. Next a roadmap for advance circular services was set up. These models show internal and external supply-side stakeholders how to implement the circular economy, and that this implementation is thinkable on a business-case level, but less evident on an industry level. This as previously unaddressed financial and regulatory aspects challenge the implementation of the circular economy in the construction industry. Considering these challenges, implementing the circular economy in the construction industry might be considered even more disruptive as in other sectors of our industrial economy.

Keywords: Circular Business Models, Construction Industry, Service Providing, Supply-Side Stakeholder

1. INTRODUCTION

Although circular economy (CE) in essence, given its constituent concepts, is not a new idea, after its launch by EMF in 2012 it gained popularity all over the world as the new sustainability paradigm (Ellen MacArthur Foundation, 2014; Van Dijk et al., 2014). Part of its popularity might be explained by the accent on the economic rationale behind the thinking, which is distinctive for CE as opposed to other sustainability concepts. Being sustainable within a CE perspective does not cost money, but is profitable for businesses as well as for the economy as a whole. The basic idea stems from price increases on –raw materials- combined with Stahel’s (2006) concept of service providing. Service providing, in essence, means that a supplier retains ownership rights over its products while clients pay (merely) for the delivered services (Bakker et al., 2014; Ellen MacArthur Foundation, 2012; Roos, 2014).

There is little to no research to be found on the implementation of CE in the construction industry, despite the fact that 40-50% of raw materials that are used each year are construction industry based, and that the sector accounts for 40% of solid waste streams, (Antink et al., 2014; Bakker et al., 2014; Bom, 2012). This might be partly explained by the lack of precedents, which makes it unclear what the construction process will look like under the influence of CE. However, as current construction processes are typified by project-based production solutions that are tailored for each individual project by project-specific teams of supplying parties, it is clear that the incentive imposed by CE upon a supplier to retain ownership rights over its products, proposes changes to current practices in the construction industry (Segerstedt & Olofsson, 2010; Van de Kaa, 2013). Furthermore, each project involves a relatively high amount of unique components that are often assembled in an artisanal way (Eastman et al., 2008). A production chain like ‘make-to-stock’ therefore does not exist in the construction industry (Segerstedt & Olofsson, 2010).

Under the influence of CE the short-term mindset that is apparent with the supplying parties in the industry will have to change to a long-term mindset and commitment, as the traditional ownership model will disappear when suppliers retain ownership rights over their products. Without changes to the current construction process as introduced above, this will lead to a situation where different stakeholders will be able to call themselves ‘owner’ of a constructed building. With more owners and (arguably) more building components it will become harder to implement CE in the construction industry, as this will increase the complexity of the process, and increase the need to cooperate. This while the industry has historically been unable to form long-term partnerships (due to the absence of a supply side focal firm among other things) (Bastein et al., 2013; Geldermans & Rosen Jacobson, 2015; Vrijhoef, 2011).

However within CE, delegating ownership to the contractor or developer responsible for the project in order to counteract the ownership problem as described above, is not a feasible option, as this would mean that the incentive for sub-suppliers to operate in a circular way would not be present any more than it is in the current construction process. Also, the long lifetime of buildings will reasonably make it financially difficult for the ‘owners’ of a circular building to retain ownership rights through for instance leasing solutions (Prins, 2017).

The circular construction industry is in need of the entry of a new stakeholder to the construction process, creating a clear focal firm for the supply-side. A research project was conducted with the objective to investigate the roles of this new stakeholder. This gave the opportunity to study what the supply side needs to offer in a (idealized) circular construction industry without being hindered by current conventions, rules and laws. This entity is referred to as ‘service provider’ (SP), and differs from the one that is proposed by the EMF (2012), in that the operations and surrounding relationships of the SP with other stakeholders are the subject of investigation. This while the SP as proposed by the EMF has a rather fixed position, with unclear operations and relations, thereby surpassing deeper research into its role. This research used the following definition of CE (adapted from Mentink, 2014): ‘a circular economy is an economic system with cyclical material loops based on a financial incentive.’ This definition does not contain anything related to the terms sustainability or value creation, as CE axiomatically implies sustainably responsible behavior by all stakeholders (Mohammadi et al., 2015; Prins, 2017).

2. METHODOLOGY

The main research question is: ‘How to organize a service provider in the construction industry in such a way that its role adheres to the definition and principles of the circular economy?’, and secondly: ‘How does this service provider relate to the current supply- and demand-side stakeholders in the construction process?’. As such, the research question will essentially deal with the organizational setup of the service provider and two different transactions; (1) between the client and the service provider, and (2) between the service provider and the supplying parties.

This research yields a final result in the form of different business models together with a complementary roadmap. These provide insight and/or solutions as to how the SP might deal with the ‘new’ context an ideal CE provides for supplying parties in the construction industry. Each model is presented through the so-called sustainable business model framework as defined by Bocken & Short (2015). This framework is used because of the match between the sufficiency-driven logic behind the framework, and the radically innovative nature of the

business models (Bocken & Short, 2015; Dangelico & Pujari, 2010; Straub, 2011). Because of their set-up, the models will also be fit for use in business plans (e.g. Osterwalder & Pigneur, 2010), and they may be used as scenario's to form a basis for scenario planning (Lindgren and Bandhold, 2003). This research is unique in that it (1) investigates the circular SP from a supply-side perspective, and (2) does this from a built-up theoretical construct that critically reflects upon both existing CE theory and the current construction industry, before coupling the construct back to practice.

There is, as of yet, no paradigm on which to build further research, so pragmatic research methods are a viable option for this research. Eisenhardt's (1989) method will be used in this research as a guideline on how to deal with different data gathering methods and the gathered data itself, resulting in a pragmatic mixed method methodology. Furthermore, for data collection methods the following frameworks have been used. (1) The literature studies undertaken in this research follow the four steps as outlined by Kumar (2011). (2) A total of 6 interviews have taken place in this research, 4 of which served to validate the theoretical construct. The validation interviews have been undertaken with different kinds of stakeholders as to provide different perspectives upon the construct. All of the interviews were of a semi-structured nature (Bryman, 2012), and subsequently coded according to Dieckx de Casterlé et al. (2012) allowing further data analysis. The software package Atlas.TI was used for this data analysis. (3) Thought experiments or exercises have been used in a similar way as 'field notes' as described by Eisenhardt (1989). (4) A total of 8 case studies have been carried out following Eisenhardt (1989), allowing for pragmatic data gathering by combining several of the aforementioned methods. Four of these served as input for the theoretical construct and four others served as input for validation of the construct and the subsequent discussion.

3. LESSONS FROM OTHER INDUSTRIES

Since the role of the SP is more mature in other industries (Schmenner, 2009), a look is given to these industries to form an understanding of the operations of this stakeholder (note the absence of CE thinking within these industries and their SP's). First of all there is a distinction between pure service providers and manufacturing service providers. The first form focuses on delivering services without any physical, underlying product (e.g. consultancy firms), and the latter form is a combination of a manufacturer and the first form (Baines & Lightfoot, 2013; Biege et al., 2012; Tukker, 2004).

Given the similarity to the construction industry, this research will focus upon manufacturing SP's. Although there are several reasons for manufacturing SP's to appear in an industry (e.g. environmental), economic reasons prevail in literature. This argument mainly follows from a substantial installed base of products, intensifying the need for companies to diversify through service providing (Bastl et al., 2012; Biege et al., 2012; Fang et al., 2008; Gebauer & Friedli, 2005; Oliva & Kallenberg, 2003; Windahl & Lakemond, 2006). Research by Fang et al. (2008) shows that it is indeed possible to obtain financial gain from offering services, under the conditions that (1) services make up at least 20-30% of the company's operations and (2) that the services are related to the provider's core business.

A manufacturing SP might offer three different kinds of services; base, intermediate, and advanced services (Baines & Lightfoot, 2013). While base- and intermediate services are product driven, advanced services are ability-driven (e.g. revenue through use) and usually require the manufacturer to retain ownership rights over its products. With advanced services

it might be necessary for the manufacturer to acquire or set-up new business units in order to be able to provide the ‘ability’ towards a customer (Bastl et al., 2012, Fang et al., 2008). This process is referred to as ‘organizational stretch’ and describes the stretch in the range of activities the service provider has to undertake in order to be able to offer these advanced services (after: Baines & Lightfoot, 2013). The dynamic between the ownership rights (together with the underlying incentive) and the presence of the organizational stretch is presented in figure 1, where the different service levels are coupled to the definition of CE. Figure 1 also captures the opposite dynamic, where base- to intermediate services are delivered. With these services, the manufacturer will not retain ownership rights over its delivered products, and therefore the incentive shift does not take place. Lessons from three case studies on circular and/or sustainable products show that, in order to guarantee sustainability (at an end-of-loop situation) in such a case, a high level of agreements of intention and/or supplier monitoring between stakeholders might be necessary, since a real incentive shift according to CE principles does not take place here.

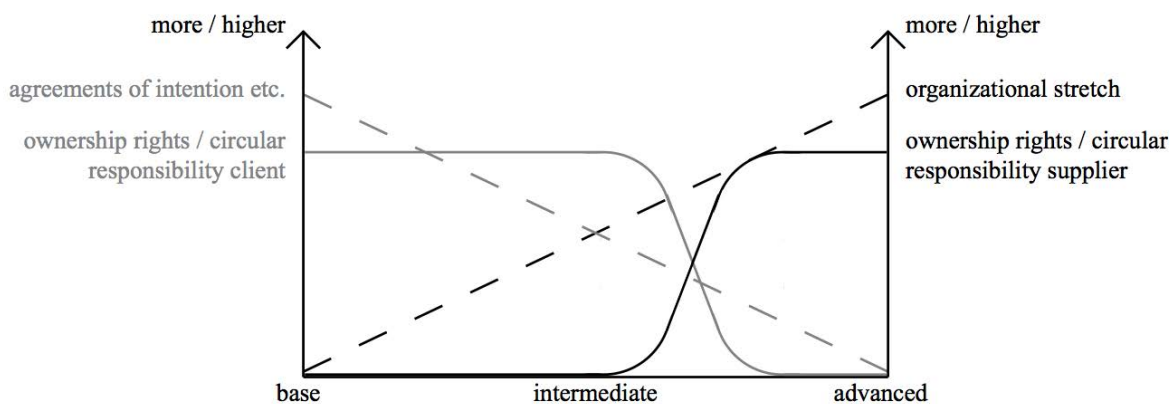

Figure 2: incorporation of CE with the service levels as distinguished by Baines and Lightfoot (2013), hereafter referred to as the ‘circular service level framework’ (CSLF) (source: own image)

At this point, a note of caution is in place as it is, as of yet, impossible to say whether offering circular services is as beneficial as offering services in general (since circular products need to be taken back, and possibly altered at the end of their lifetimes). These costs are currently not incurred by the observed SP’s in other industries. Therefore this circular step will only be beneficial when resource prices are on a constant rise. If resource prices are not on a constant rise, it comes down to the ability of the circular SP to be more efficient in using circular materials as opposed to using ‘new’ resources, in order to make circular business operations not more expensive than linear operations. This observation links-up with the definition of CE, and leads to the following statement: ‘a CE business strategy is a strategy that, if governed correctly, is sustainable’.

4. ADVANCED CIRCULAR SERVICES BUSINESS MODELS

Through figure 1 it becomes clear that the chosen level of services has consequences for the cooperation between SP and client. If the client opts for base to intermediate services, possible solutions for circularity can be found in, e.g. buy-take-back or buy-buyback solutions with the SP. If the client opts for advanced services, possible solutions for circularity can be found in e.g. financial- or operational lease constructions. This study focuses on designing circular business models for advanced services. This is done for two reasons; (1) an advanced services

model is as of yet not present in the construction industry, as opposed to base- to intermediate services solutions of which some examples can already be found (see: Van den Brink, 2016). (2) Offering capabilities (through advanced services) show the greatest potential for profitability and sustainability gains (mainly through the incentive shift) (Tukker, 2004).

When providing advanced services, the SP needs to offer a performance that is supported by a service that optimizes said performance. The performance is based upon a delivered product (i.e. the building). The building is a collection of products (providing services) that are interrelated at different scale levels and characterized by their economic life span (partly based upon and adapted from: Prins, 1992). These products are delivered by the SP, in combination with (different) supplying parties, but the SP manages the overall performance. In order to be able to operate in the above way, several requirements need to be in place for the service provider to operate effectively. (1) The client should ask for performances (product specific housing services) instead of physically defined products (Jonker, 2015). (2) Client-demand for the performance should not specify the to be delivered performances too much, as this will impede upon the ability of the SP to deliver a competitive service (Sexton & Barret, 2005). (3) Because of the increased complexity, and intensified and prolonged relationships between stakeholders within a circular construction industry, a tighter organization on the supply side's part with willingness, trust, and transparency is needed among these stakeholders (Bastl et al., 2012; Geldermans & Rosen Jacobsen, 2015). (4) If suppliers should be able to take back their products at the end of the building lifetime, they should be able to do so without damaging these –and each others’- products. Therefore the used products should make use of so-called ‘decoupling points’ that connect the different products together constituting a building.

Through the lessons learned, five different advanced services business models can be made, based upon three underlying variables. (1) The competences that are present within the organization of the SP (as an SP should only pursue offering services in those areas that are part of its core business); (2) presence of an organizational stretch; (3) the relationship with suppliers. Variables two and three allow for different ways to deal with the high fragmentation and traditional ways of cooperation between the different supplying parties that persist in the construction industry. These aspects only influence certain elements of the different business models, therefore the largest part of the business models will be the same (see figures 2,3). Distribution channels and growth strategy are provider-specific and will differ for each provider, these are therefore not worked out in detail in this research. A description of the business model prototype is presented following the building blocks of Bocken & Short (2015);

1. Value proposition

The product/service that the SP delivers is; housing for a client through a performance that is completely tailored to said client's specific needs. In offering its product, the SP is faced with a broad segment of clients looking for a specific performance. The relationship with the client is provider-specific, however since the SP offers a tailored service it is important that the client is in close contact with the SP. The value for the customer is thus that he receives fully tailored housing. The value for society and environment can be found in the fact that this housing is delivered in a sustainable manner. And the value for the SP is economical in attracting business with higher profit margins and prolonged client relations (see section 3).

2. Value creation and delivery

The SP performs either all of the following activities: designing, building, financing, maintaining, and operating, or (more likely) it performs one or more of these activities. If the SP performs the ‘financing’ activity, this is always done in combination with one of the other

activities, as the product or (performance) on offer is supported by an underlying (physical) product. Besides these activities, the SP will be responsible for the operational lease-solution towards the client. Following this responsibility, the SP is also responsible for picking those products (if needed from upstream suppliers) to compose a building that allows for the agreed upon performance(s) to be met. This also means that it is the SP's responsibility to verify whether the incorporated products can actually deliver upon this requirement. Following the SP's activities, one of its core resources is the inherent knowledge it has about the activities it performs.

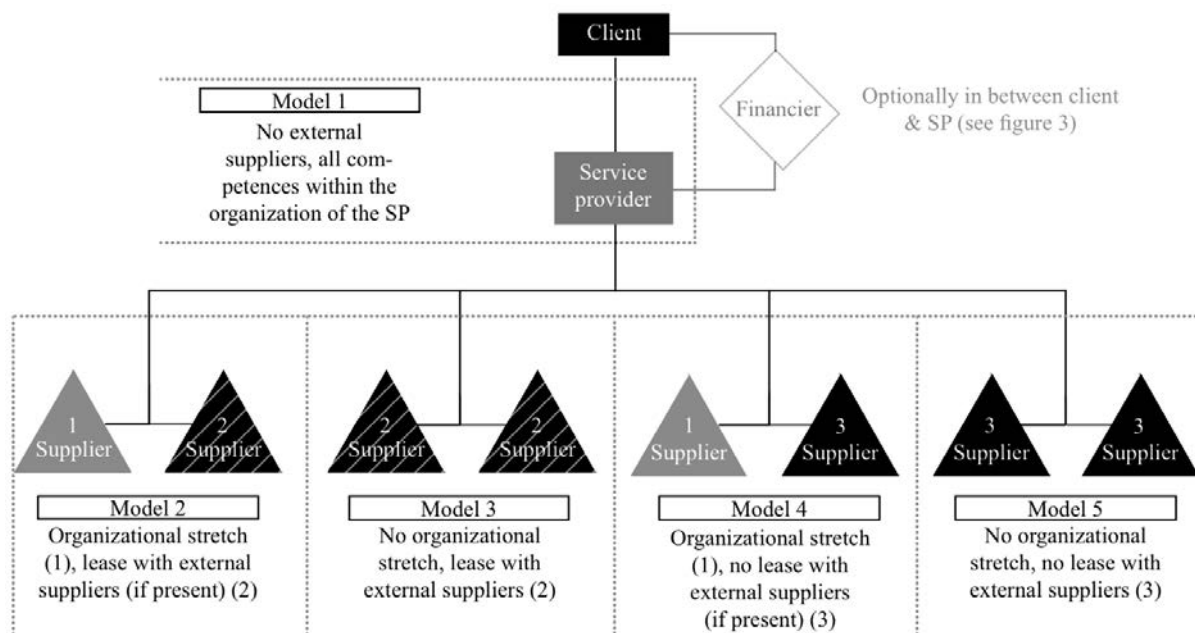

Figure 2: Characteristics of the partners and suppliers of the five advanced circular business models (source: own image).

The partners and suppliers are subject to the underlying variables and are worked out in five different models (see figure 2). Although the relevant partners and suppliers differ depending upon the chosen model, the partners will always involve one or more of the following: the client, external suppliers and/or financiers. The client always is a key partner because of the product on offer. Figure 2 exemplifies the way the different models are composed, where the link with the financier is optional depending upon the financial means of the service provider. Furthermore in figure 2, suppliers can be related to the SP through an organizational stretch (its presence being dependent upon the chosen model). Other suppliers are related to the SP through a lease-solution, and the final group of suppliers are not related to the SP through a lease-solution.

3. Value capture

The value capture and cost- and revenue streams depend upon the underlying variables and the effects thereof are shown in figure 3. For instance, if an SP would choose for a model 3 solution over a model 1 solution, the amount of (external) stakeholders would be larger and therefore the complexity of model 3 would (reasonably) be higher. This is recognizable in figure 3 under the more extensive cost structure for model 3 when compared to model 1. Similar analyses between the other models show that model 1 comes closest to CE theory as it was outlined in this research, whereas the other models can be placed closer to intermediate services solutions (with model 5 coming the closest to intermediate solutions).

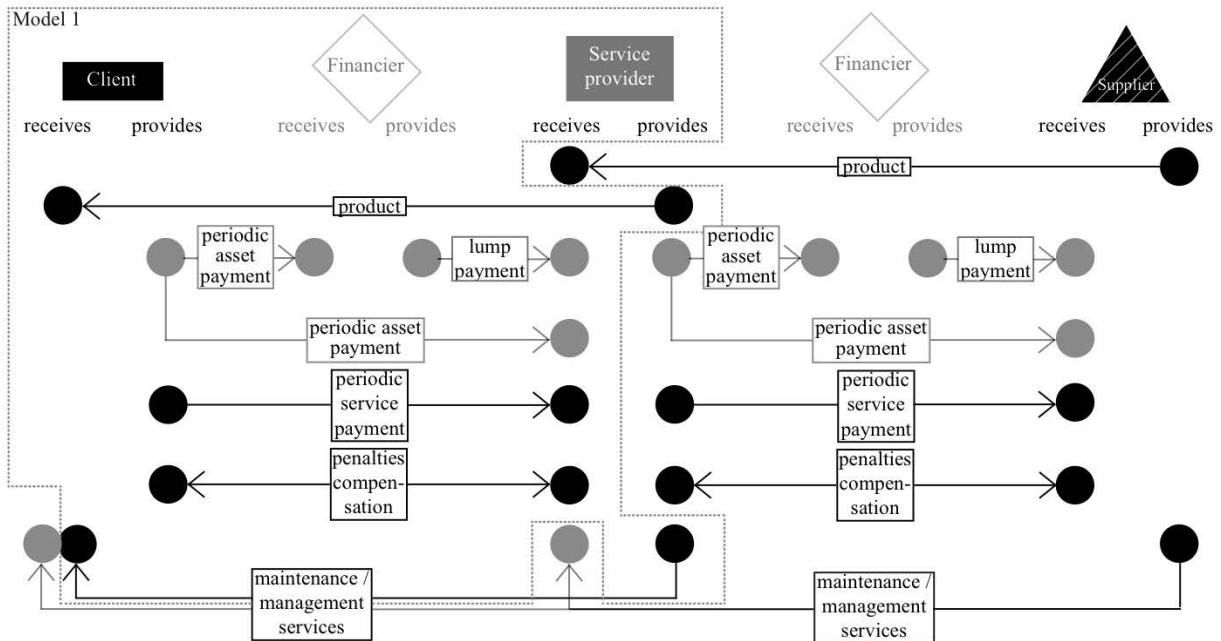

Figure 3: The cost structure and revenue streams of model 1 (in between the dotted line) & model 3 (whole image including the area in between the dotted line); the black streams represent necessary relations, while the grey streams represent possible relations. Similar structures can be made for the other models (source: own image).

5. EXPERT CONSULTATION

Expert consultation took place on the above business models (two contractors, a contractor/developer and a maintenance provider). When asked whether CE could be seen as a potential business opportunity, all parties replied that this is, or could indeed be, the case. However, the respondents think it is unlikely that they would enter into an organizational stretch or into lease-solutions (with clients) in the near future. Concerning these solutions, the respondents would primarily enter into lease-solutions with suppliers with whom they work together in multiple projects (so called ‘chain-partners’ or ‘co-makers’), as opposed to one-off suppliers. As three out of four interviewees indicated that they are already involved in contracts with longer project commitments, it is clear that the respondents did not regard longer commitments as an issue. Concerning both re-design and long-term commitment, the (financial) value of a product at an end-of-loop situation is seen as a big question by the interviewees, as three out of four interviewees state that this value will be (predominantly) determined by the ease with which products will be able to be redeployed in other projects.

For the respondents this raises the question as to how this uncertainty will be incorporated into the product-price. And if, in return for taking on more risk on the supply-side’s part, products offered through advanced services will not be more expensive than ‘traditional’ products, due to a risk-premium. In the end, three out of four respondents ended up with either model 3 or 5, whereas one of the interviewees also thought of model 2 as a plausible future business model. One interviewee could not relate himself to any of the prototypes yet, but explained that if advanced-services models would prove to be fruitful, his company would naturally pursue these solutions as well. Among the other respondents, two contractors would see themselves as an SP in the developed variants, while an interviewed maintenance provider would prefer to be a supplier.

6. FURTHER ANALYSIS OF THE BUSINESS MODELS

In general, the respondents acknowledged the requirements and business operations of the SP as presented in this study. However, with the respondent's short-term belief in base- to intermediate circular services, the sustainable impact of CE will reasonably only be incremental if implemented at these service levels. This as we have seen in section 4 that offering capabilities (through advanced services) show the greatest potential for sustainability gains (Tukker, 2004). In the long term however, the advanced business models were seen as probable, with models three and five being seen as the most probable. A possible explanation for this can be found in the fact that among the developed models, these two bear the highest amount of similarities with the current construction industry. Especially if these variants are realized through consortia, they show a resemblance towards public-private-partnership solutions that are becoming more common in the construction industry.

It remains somewhat unclear which stakeholder would be able to pick up the role of the SP. Given that the competences inherent in an organization determine the capability to act as a service provider, it is surprising that parties like contractors see themselves as fit to perform the role of the SP, as the consulted contractors view their role as one of 'merely' coordinating. However in the light of the fragmented supply chain it might just be these parties that are able to attract the necessary competences the easiest, as attracting competences in a construction project is already part of their current operations.

Given the fact that the respondents have a preference for models 3 and 5, and for operating in consortia, the topic of the organizational stretch can be discussed. If the SP would be an existing party in the construction industry, this role would most likely be formed through a consortium. In this consortium, parties that are currently coordinating the building process might be best suited to perform a leading role (a de facto SP), as we have seen that attracting competences is part of their current operations already. However these consortia could need to be of a considerable size, i.e. meaning that these leading parties could be heavily reliant upon external suppliers to obtain enough competences for the realization of the project. Besides that, the costs that are associated with setting up a consortium can be quite high (Straub, 2007). Considering these aspects, it seems that advanced circular services projects that are delivered through models 3 & 5 with a consortium might need to be of a considerable (financial) size like current DBFMOs.

7. DISCUSSION

The interviews also revealed some challenges that could limit the probability of use of the business models;. First, there are several legal issues that arise through the implementation of CE under Dutch property law (remarkably however, none of the interviewees mentioned this aspect). Through the rule of accession, delegated ownership of individual components that are part of a larger construction is principally prevented. Although some (very specific) exceptions can be made to the rule of accession (e.g. right of rem), and its foundations are at least questionable from the perspective of CE, it cannot be expected that the rule will be changed in the near future. When a look is given to the different models, this means that any model that engages stakeholders into 'shared' ownership (i.e. all variants except number one) of the building will only be possible through a consortium. This consortium as a unity will hold the ownership rights of the entire building, while internal contract agreements have to be made between stakeholders to ensure that products are returned to the right stakeholder at the end of

the building's lifetime. These internal contracts cannot lay a claim upon the ownership right of particular products in the building, but may for instance represent shares in the consortium that represent the value of the underlying products. A possible solution, given the similarity with current integrated contracts, could be a 'design, build, finance, maintain, operate, and return' (DBFMOR) contract, which would operate in a similar way as DBFMO-contracts, but also contains the internal contracts needed for the proper return of products at an end-of-lifetime situation. In such a situation it can be questioned whether the term 'operational lease' does any justice to the operational reality, because it does not make any sense for suppliers to provide their products through a lease-solution as this does not provide them with ownership rights over their products, rendering model 3 an improbable solution.

Another issue is financial uncertainty; Stigter's (2016) findings deal with this uncertainty and show that the profitability of circular lease-solutions is mostly dependent upon resource price levels. Stigter (ibid) found that a decline in capital gain by just 2% (i.e. a decline in resource prices by 2%) causes a decline in the internal rate of return of around 8%, making these lease-solutions volatile. Thereby acknowledging that CE does not need to be sustainable under situations where resource prices are not increasing. Furthermore, in accordance with the respondents and Stigter's work it seems one has to take a 'substitution risk premium' into account when modeling the costs of lease-solutions. This substitution risk premium is necessary because of two factors: first, regulation might change over time, possibly rendering a product obsolete after a period of time. Second, today's building materials and products might not be the building materials of tomorrow, influencing future demand for these materials.

Further investigation by the researchers, although not acknowledged by the interviewees, shows that, despite the fact that the models attempt to mitigate financial risks by utilizing a similar way of financing as in ESCO's (Zhang et al., 2015), the long product lifetimes in the construction industry do complicate the profitability of lease-solutions. Prolonged ownership of products by supplying parties in the construction industry is likely to have a significant impact on the liquidity and solvency rates of these companies (Prins, 2017). These findings increase the likelihood of advanced circular services models appearing through model 5 with consortia. This also increases the likelihood that the SP would be a supply side party with high amounts of (own) equity, as these parties would arguably be able to suppress the cost of capital that is necessary (Prins, ibid). Within the construction industry, the modus operandi of contemporary real estate investors seems to fit this bill. Outside of the industry, a thought may be given to e.g. Dutch pension funds. For other regular construction companies as known on today's markets, which are primarily capacity and service driven, acting business case wise in consortia is thinkable, but one might question the abilities to cope with the equity demands needed to make a shift in terms of their business model.

Although market demand is as of yet not present (which might be due to the organizational difficulties of advanced circular services), the respondents think that emergence of this demand is likely. In other industries it seems that risk outsourcing is the main reason for demand for advanced services to appear (Baines and Lightfoot, 2013). Translated to the construction industry, this could mean that demand for advanced circular services is most likely to arise with parties whose housing needs are uncertain over longer periods of time. Examples of parties that would demand these services could therefore be; parties that deal with temporary demand, new businesses (start-ups), businesses that need to be on a particular location for the duration of a particular contract, and/or parties liking to maintain their liquidity and solvency rates (or which cannot afford the initial investment costs), associated with housing.

8. A ROADMAP FOR ADVANCED CIRCULAR SERVICES

Although in the short-term base- to intermediate circular services are more likely to appear than advanced circular services, limiting the sustainable impact of CE, in the long-term the developed prototypes are considered probable by the interviewees. In the discussion several legal and financial issues were taken into account. Based upon these findings it is possible to create the following roadmap for the delivery of these advanced circular services:

1. The circumstances meet the requirements as set out in section 4, concerning value propositions, -creation, -delivery and -capturing.
2. The supplying party is willing to deliver advanced circular services, and expects resource prices to rise in the future. Thereby ensuring the sustainability of the offered advanced circular services. Furthermore, the SP has enough equity to sustain the delivery of advanced services over a longer period of time as part of their wider business model.
3. After these requirements are met, the SP starts with determining the lifetime of the building, as well as the economic lifetime of its constituent parts, which depend on the length of the contract with the client, as well as expected market prices respectively.
4. The SP picks or develops those products that are able to meet the agreed upon performance, as well as which contain future market value to ensure multi cyclic behavior.
5. The SP needs to deal with the specific characteristics of the construction industry through the choice for one of the developed models. If a model other than number one is chosen, a consortium needs to be set-up that makes use of a so-called ‘DBFMOR-contract’. For making a transition to a CE, these types of contracts need adjustments being feasible and thinkable for all sorts of construction projects.
6. The SP takes on the operational responsibilities towards the client regarding the lease during the contract period.
7. The SP makes sure, through incorporation into its business model or through agreements of intention, that the used products are redeployed, one way or another, at the end of the contract or at an end-of-loop situation, in any case not generating waste nor resulting in the need to –excessively- mine new raw materials.

If the roadmap were to be followed by a, currently, internal stakeholder in the construction industry, it would likely be carried out through model 5. This would be done through a consortium, which contains a supplying party with enough equity (e.g. a contemporary real estate investor). Given the high initial investment costs associated with integrated contracts and consortia, this solution would arguably only be viable for considerably sized projects. Also, from a CE point of view, model 5 does not represent the most theoretically pure solutions, and although these models propose a radically different way of working, their impact on current stakeholders might be (relatively) limited. Interesting in this respect is that current Dutch property law complicates the feasibility of theoretically more pure solutions (excl. model 1), contradicting the ‘leasing narrative’ as linked with CE in the (Dutch) construction industry.

9. CONCLUSIONS

Current business models as propagated in the literature on ‘CE success cases’ most often concern – (relatively) fast moving- consumer goods, like ‘lease a jeans’, ‘pay per wash’, and ‘pay per lumen’. The rather abductive study reported on in this paper started with the aim to design an organizational set-up for a ‘CE Service Provider’ within the construction industry. As the project progresses, more and more also rather fundamental challenges and barriers were found.

This study shows that, implementing CE within the construction industry is less evident but thinkable on a business case level. However, CE business models for the construction industry are at the moment far less evident as sometimes assumed within current markets and under current regulations. The main challenges and barriers found for CE service providing within the construction industry are very limited, if not at all, addressed in CE literature, nor are acknowledged, this as far as according to our findings, by construction industry partners.

CE thinking in general as acknowledged in literature has a rather disruptive nature in both its axioms (e.g, the availability of clean and cheap energy and the assumed moral sustainable behaviour of the industry and their markets), and in needed adaptations on current regulations as for instance reducing the tax on labour (ExTax) and preventing VAT accumulation while riding the –technical- loop (Mohammadi et.al. 2015; Prins, 2017). Considering these challenges, implementing CE in the construction industry might be considered even more disruptive as in other sectors of our industrial economy.

10. REFERENCES

- Antink, R., Carrigan, C., Bonneti, M., & Westaway, R. (2014). Greening the building supply chain. Nairobi: United Nations Environmental Programme.
- Azcárate-Aguerre, J.F., Klein, T. and Den Heijer, A. (2017). Facade Leasing Upscaler Preparation Project, Delft University of Technology, Delft.
- Baines, T., & Lightfoot, H. (2013). Made to serve: how manufacturers can compete through servitization and product-service systems. Chichester: John Wiley and Sons.
- Bakker, C., Wang, F., Huisman, J., & Den Hollander, M. (2014). Products that go round: Exploring product life extension through design. *Journal of Cleaner Production*, 69, 10-16.
- Bastein, T., Roelofs, E., Rietfeld, E., & Hoogendoorn, A. (2013). Opportunities for a circular economy in The Netherlands. Alphen aan den Rijn: Drukkerij Holland.
- Bastl, M., Johnson, M., Lightfoot, H., & Evans, S. (2012). Buyer-supplier relationships in a servitized environment. *International Journal of Operations Management* 32(6), 650-675.
- Biege, S., Lay, G., & Buschak, D. (2012). Mapping service processes in manufacturing companies: industrial service blueprinting. *International Journal of Operations Management* 32(8), 932-957.
- Bocken, N., & Short, S. (2015). Towards a sufficiency-driven business model: Experiences and opportunities. *Environmental Innovation and Societal Transitions* 18, 41-61.
- Bom, J. (2012). The circle economy in practice. Nederhorst den Berg: Atticus.
- Bryman, A. (2012). *Social Research Methods*. 4th ed. Oxford: Oxford University Press.
- Dangelico, R., & Pujari, D. (2010). Mainstreaming green product innovation: Why and how companies integrate environmental sustainability. *Journal of business ethics* 95, 471-486.
- Dierckx de Casterlé, B., Gastmans, C., Bryon, E., & Denier, Y. (2012). QUAGOL: a guide for qualitative data analysis. *International Journal Of Nursing Studies* 49, 360-371.
- Eastman, C., Teicholz, P., Sacks, R., & Liston, K. (2008). *BIM Handbook: a guide to building information modeling for owners, managers, designers, engineers, and contractors*. Hoboken: Wiley and Sons.
- Eisenhardt, K. (1989). Building theories from case study research. *The Academy of Management review* 14(4), 532-550.
- Ellen MacArthur Foundation. (2012). Towards the Circular Economy: Economic and Business Rationale for an Accelerated Transition (Report). Cowes: Ellen MacArthur Foundation.
- Ellen MacArthur Foundation (2014). Accelerating the scale-up across global supply chains (Report). Cowes: Ellen MacArthur Foundation.
- Fang, E., Palmatier, R., & Steenkamp, J. (2008). Effect of service transition strategies on firm Value. *Journal of Marketing* 72(5), 1-14.
- Gebauer, H., & Friedli, T. (2005). Behavioral implications of the transition process from products to services. *Journal of Business and Industrial Marketing* 20(2), 70-78.
- Geldermans, B., & Rosen Jacobson, L. (2015). Materialen & Circulair Bouwen: Vervolgonderzoek Pieken in de Delta project REAP+. Delft: Delft University of Technology.
- Jonker, J. (2015). Nieuwe Business Modellen: Samen Werken aan Waardecreatie. The Hague: Academic Service.

- Lindgren, M., & Bandhold, H. (2003). Scenario planning; the link between future and strategy. New York: Palgrave MacMillan.
- Mentink, B. (2014). Circular business model innovation: a process framework and a tool for business model innovation in a circular economy. Delft: Delft University of Technology.
- Mohammadi, S., Prins, M., Slob N. (2015) Radical Circular Economy. In: Egbu, C. eds. Going North for Sustainability: Leveraging knowledge and innovation for sustainable construction and development, Proceedings of the CIB International Conference held at London South Bank University 23-25 November 2015, pp. 451- 461, IBEA Publications Ltd, London. (Retrieved from: (<http://repository.tudelft.nl/islandora/object/uuid:b80ad8fd-3ffc-48cf-a1b6-82554a3a9a3c?collection=research>))
- Oliva, R., & Kallenberg, R. (2003). Managing the transition from products to services. *International Journal of Service Industry Management* 14(2), 160-172.
- Osterwalder, A., & Pigneur, Y. (2010). *Business Model Generation*. Hoboken: John Wiley and Sons.
- Prins, M. (1992). Flexibiliteit en kosten in het ontwerpproces; een besluitvormingsondersteunend model. Eindhoven: Technische Universiteit Eindhoven.
- Prins, M. (2017). Circulaire Economie; kansen en barrières voor het hergebruik van gebouwcomponenten, in: Neele, H., Weelink, J.H., Welle R. van der, eds. *Online publicatie Collectie Overheid – Omgevingswet, Module Afval*. Wolters Kluwer, Deventer. FC. pp. 1-10.
- Roos, G. (2014). Business model innovation to create and capture resource value in future circular material chains. *Resources* 3, 248-274.
- Schmenner, R. (2009). Manufacturing, service, and their integration: some history and theory. *International Journal of Operations and Product Management* 29(5), 431- 443.
- Segerstedt, A., & Olofsson, T. (2010). Supply chains in the construction industry. *Supply Chain Management: an International Journal* 15(5), 347-353.
- Sexton, M., & Barret, P. (2005). Performance-based building and innovation; balancing client and industry needs. *Building Research and Information* 33(2), 142-148.
- Stahel, W. (2006). The performance economy. London: Palgrave MacMillan.
- Stigter, R. (2016). Suppliers going circular. Delft: Delft University of Technology.
- Straub, A. (2007). Performance-based maintenance partnering: a promising concept. *Journal of Facilities Management* 5(2), 129-142.
- Straub, A. (2011). Maintenance contractors acting as service innovators. *Construction Innovation: Information, process, management* 11(2), 179-189.
- Tukker, A. (2004). Eight types of product-service system: eight ways to sustainability? Experiences from SUSPRONET. *Business Strategy and the Environment* 13, 246-260.
- Van de Kaa, B. (2013). Vastgoed en de circulaire economie: Een toekomstverkenning. Amsterdam: Amsterdam School of Real Estate.
- Van den Brink, R. (2016). At your service! Circular business model prototypes for a service provider in the construction industry. Delft: Delft University of Technology.
- Van Dijk, S., Tenpierik, M., & Van den Dobbelaer, A. (2014). Continuing the building's cycles: a literature review and analysis of current systems theories in comparison with the theory of cradle to cradle. *Resources, conservation, and recycling* 82, 21-34.
- Vrijhoef, R. (2011). Supply chain integration in the building industry: the emergence of integrated and repetitive strategies in a fragmented and project-driven industry. Amsterdam: IOS Press.
- Windahl, C., & Lakemond, N. (2006). Developing integrated solutions: The importance of relationships within the network. *Industrial Marketing Management* 35, 806-818.
- Zhang, X., Wu, Z., Feng, Y., & Xu, F. (2015). Turning green into gold: a framework for energy Performance contracting (EPC) in China's real estate industry. *Journal of Cleaner Production* 109, 166-173.

MANAGING ORGANISATIONAL INNOVATION CAPACITY FOR CONSTRUCTION INNOVATIONS

L. Zhu¹ and S. O. Cheung²

¹ *Construction Dispute Resolution Research Unit, Department of Architecture and Civil Engineering, City University of Hong Kong, Hong Kong*

² *Construction Dispute Resolution Research Unit, Department of Architecture and Civil Engineering, City University of Hong Kong, Hong Kong*

Abstract: Faced with the challenges arising from globalization of construction market, construction is no longer a local industry. In addition, traditional demarcation of responsibility between design and construction has blurred to the extent that many contracting organisations are offering complete services covering both design and construction. Competition for project therefore is no longer based singularly on price. In this regard, innovation has proved to be the most critical competitive advantage for multinational contracting organisations. Innovative organisations are those that have the capacity to develop innovations. Having organisational innovation capacity (OIC) is thus a necessary condition for innovation developments. OIC also provides the energy for strategic re-structuring, re-orientation and re-organisation. Prior studies on OIC have been mostly industry-specific. Construction organisations would benefit from a construction specific OIC constructs to guide their long-term development. This paper reports a study for this purpose. A construction specific OIC framework is proposed with data collected from 102 construction professionals and application of exploratory factor analysis (EFA). Accordingly, four main factors of OIC are found and these are (i) organisational learning and communication, (ii) innovation culture, (iii) organisational career management, and (iv) entrepreneurship. The ANOVA test results suggest no significant difference between contracting organisation type and respondents' job position. The relative importance rankings among these factors are also illustrated through their significance scores. It is further found that entrepreneurship is the most effective OIC. Based on the findings, suggestions such as developing clear strategic objectives are offered.

Keywords: Factor Analysis, Organisational Innovation Capacity, Organisational Management

1. INTRODUCTION

Construction organisations are now competing in a rapidly changing and demanding environment (Arad et al., 1997). The pace of change is unprecedented due to globalization and technological advancements. The demand is mounting with the degree of sophistication and users' expectations. Furthermore, construction is no longer a local business with competitors can come from any part of the world. Unrestrained competition suppresses the profit margin if price is the sole comparator. (Ball et al., 1999). Thus, low bid strategy is no longer effective in the global market. Porter (1990) suggested that cost-minimization strategy is not sustainable for long-term development. Diversifying is one way for them to stay viable. Cheung and Chan (2015) suggested that embracing differentiation through establishing innovation ambidexterity would provide the genuine and effective competitive edge. The study also identified four types of innovation: product, process, organisational and technology (Cheung & Chan, 2015). Technological innovation is the centre of attention as it has made remarkable achievements in improving construction efficiency. It should also be noticed that there is a close relationship between organisational innovation and technological innovation. Kimberly and Evanisko (1981) found that changes of some organisational characteristics have significant impact on technological innovations. Camisón and Villar-López (2010) further put forward that organisational innovation is an enabler of technological innovation and an inducer of

organisation performance. This conclusion is supported by an investigation of 121 construction projects by Chen (2012). The positive correlation is clearly shown between technology and human aspects of innovation performance at project level. All these studies found the value of organisational innovation that embraces changes that accord opportunities for construction organisations to develop new technologies. Organisational innovation capacity (OIC hereafter) should be improved at the same time to fit in the new trend of the world. Advanced management skills are exemplary organisational capacity in innovative industries such as computing and multi-media. In 1994, Nippon Telegraph and Telephone (NTT) Group, a traditional telephone company aimed to carry out organisation transformation to create something new. Strategic community management was used as an innovation technique for this large and established organisation (Kodama, 1999). Some successful systems such as Phoenix were therefore developed. NTT Group is now one of the world's leading telecommunications organisations. Market leaders are characterised by their ability to command technological breakthrough and master organisational innovations.

This study aims to investigate this proposition. The objectives of this study include:

- Exploring the constructs of OIC.
- Identifying the significant facilitators of OIC.
- Suggesting ways to enhance OIC.

This paper is organized with four parts. The concepts and facilitators of OIC are first discussed. The second part reports data collection and analysis. The third part discusses the findings and suggestions. The final part gives the conclusions.

2. THE CONCEPTS AND FACILITATORS OF OIC

2.1 The concepts of OIC

Organisational innovation is the successful implementation of creative ideas within an organisation (Amabile, 1996). Organisation for Economic Co-operation and Development (OECD) (2005) defines organisational innovation as “the implementation of a new organisational method in the undertaking’s business practices, workplace organisation or external relations”. Differing from organisational change, it involves the implementation of new methods or new strategies which have not been used before (OECD, 2005). Armbruster et al. (2008) suggested two types of organisational innovations:

- Structure innovation: To achieve organisational effectiveness, this type of organisational innovation mainly focuses on the optimization of the organisational structure.
- Procedure innovation: It is the optimization of products. The production procedure is optimized to save cost and improve quality.

Battisti and Stoneman (2010) extended the definition to practicing new marketing concepts and new corporate strategies. Damanpour and Aravind (2011) put forward that organisational innovation is to use new approach and knowledge to produce new changes in the organisation's strategy, structure, administrative procedures and systems.

Organisational innovation is influenced by several organisational characteristics. Organisation type and scale are effective moderators between facilitators and innovations (Damanpour, 1991). Low specialization increases the overlapping of task domains and encourages people to innovate (Arad et al., 1997). It means moderate freedom and space are promoters of organisational innovation. Frequency of innovation is also decided by organisation management methods. The aspects of organisational structure and its reward strategy are also highly related to organisational innovation (Moch & Morse, 1977).

OIC is therefore viewed as a corresponding ability to substantively change organisational structure, execute advanced management techniques or significantly change corporate strategic orientation (OECD 2005; Asad et al., 2005) for the benefits of nurturing innovations.

2.2 The facilitators of OIC

OIC is more human oriented. Innovative organisations are benefitted from the exemplary leadership of the management. The project performance is influenced by leadership style (Larsson et al., 2015). In particular, an inspiring leader is pivotal in cultivating innovation capacity. Amabile (1996) suggested that entrepreneur are leaders who have novel ideas to create and deliver new things continuously. Leadership is the core trait of innovation (Chen, 2012). Organisational innovation climate is created through leader's support and psychological empowerment of followers (Gumusluoglu & Ilsev, 2009; Jung et al., 2003). Based on their study, García-Morales et al. (2012) expanded this framework and found transformational leadership influences OIC positively partly through organisational learning. Responsibilities should be taken by them to identify opportunities and put them into practice (Schwartz & Bear, 1991). Organisations can benefit from a clear strategy of promoting innovations (Li, 2009). The value of employees is recognized by Prajogo and Ahamed (2006). Regular training for employees is key practice for innovative behaviour building. Inspiration is needed to develop working skills, career paths and team cooperation. Besides, measuring their satisfaction and monitoring their career progression are admirable ways to allocate and retain skilled workers for construction organisations.

Amabile (1996) proposed that organisations should create an environment to cultivate the willingness and desire of staff members to innovate. It is suggested that incentive policies are essential to cultivate organisational innovation. Making full use of external resources and cooperating with others would help organisations to continual transformation through self-renewal. Dobni (2008) proposed seven factors that organisations need to achieve to create an innovative environment: innovation propensity, organisational constituency, organisational learning, creativity and empowerment, market orientation, value orientation, and implementation context.

Strategies for organisation innovation are usually result in two aspects: market impact and internal preparation. An effective operation mechanism helps reflect chances to develop OIC. Pedler et al. (1997) illustrated the importance of establishing a learning organisation. The pace of organisational innovation is decided by continuous knowledge enhancement and improvement (Chinowsky et al., 2007). Empirical studies support the contribution of organisational learning towards OIC. Organisational learning has become a need rather than a choice as it directs the pace and speed of organisation development. Senge (2006) reported several characteristics of a learning organisation. Shared vision is the outcome of a creative orientation and generative conversation closely linked to the ability to share a mental image of

the future. Personal mastery is the commitment made for the process of learning. The difference between these two factors is that shared vision is for team-building and personal mastery propels organisational advancement through the effort of innovative individuals (García-Morales et al., 2006). With the rise and development of knowledge economy, construction organisations must also embrace learning (Cheung et al., 2015). This is a way to constantly adapt to the changes of the environment.

Brynjolfsson and Hitt (2000) suggested that good communication network is the foundation of continuous organisation restructuring and organisational innovation. An efficient communication network provides market updates to help organisations renew their structure (Ball et al., 1999). Monge et al. (1992) collected weekly data through five organisations to analyse how communication frequency and quality influence innovation behaviours. The result indicated that communication variables are significant causes of organisational innovation. The active use of advanced information technology accelerates the speed of organisation innovation and improves firm performance in Canada (Gera & Gu, 2004). Both empirical studies affirmed the value of information management.

Based on all these literatures, the main facilitators are concluded in Table 1:

Table 1: facilitators of OIC in construction

No.	Facilitators	Reference
1	Have clear strategic objectives	Li, 2009
2	Seize opportunities and put them into practice	Schwartz, 1991
3	Have transformational leadership ability	Larsson et al., 2015
4	Carry on inspiration	Prajogo & Ahamed, 2006
5	Make good career planning management	Prajogo & Ahamed, 2006
6	Have regular team training	Prajogo & Ahamed, 2006
7	Measure team members' satisfaction regularly	Prajogo & Ahamed, 2006
8	Cooperate with partners well	Battisti & Stoneman, 2010
9	Have the willingness to change	Amabile, 1996
10	Promote incentive policy	Amabile, 1996
11	Support for trying and innovative ideas	Amabile, 1996
12	Maintain communication openly with external resources	Damanpour, 2011; Monge et al., 1992
13	Spend time learning new things	Tidd et al., 2001
14	Achieve personal mastery	Senge, 2006
15	Devote effort to learning from each other	Senge, 2006
16	Establish good communication network	Ball et al., 1999

3. DATA COLLECTION AND ANALYSIS

3.1 Data collection

A questionnaire was set to investigate the constructs of OIC. The questionnaire consists of two parts. The first part is to solicit the respondents' personal information. The second part includes 14 questions that are developed from Table 1. All the respondents need to score the importance of these factors in a Likert scale of 1 to 7.

This questionnaire is distributed in both mainland China and Hong Kong. The respondent targeted are employees from construction contracting companies. 102 construction professionals responded to this investigation. Table 2 and Table 3 present the personal

information of the respondents. The ANOVA test result shows there are no significant differences among different types of organisations and job positions in all these questions.

Table 2: type of organisations

Type	Num	Ratio
Main-contractor	71	70%
Sub-contractor	31	30%
Total	102	100%

Table 3: The position of the investigators

Position	Num	Ratio
Staff	73	72%
Manager	29	28%
Total	102	100%

3.2 Data analysis

To analyse the construct of OIC, exploratory factor analysis (EFA) is used. The extraction method is principal component analysis and the VARIMAX rotation is performed (Hair et al., 2008). The result of EFA of OIC is shown in Table 4. Loading less than 0.500 are not shown. The Cronbach alpha indexes of these four factors suggest that the initial consistency are confirmed. The KMO is higher than 0.600 and the Bartlett test of sphericity is also significant (Hair et al., 2008). All these variables can be divided into four groups. They account for 74.6% of the total variance. It is considered sufficient to explain OIC in construction by using these factors (Sharma, 1996). These four factors can be identified as: 1) Organisational learning and communication; 2) Innovation culture; 3) Organisational career management; and 4) Entrepreneurship.

These factors contain different aspects of OIC. Organisational learning and communication is the efficient system for knowledge and information updating. Innovation culture supports for organisation members to innovate continuously. Entrepreneurship is an organisation having the leadership and vision to create and influence the environment (García-Morales, et al., 2006). Organisation career management mainly focuses on retaining talents as it shapes the scale of organisational innovations.

Table 4: Results of factor analysis on OIC

No.	Name	OIC taxonomies			
		1	2	3	4
V1	Achieve personal mastery	.606			
V2	Devote effort to learning from each other	.630			
V3	Maintain communication openly with external resources	.790			
V4	Establish good communication network	.731			
V5	Have good corporation with partners	.741			
V6	Have the willingness to change		.566		
V7	Promote incentive policy		.506		
V8	Support for trying and innovative ideas		.721		
V9	Spend time learning new things		.647		
V10	Have regular team member training		.811		
V11	Carry on inspiration			.857	
V12	Make good career planning management			.602	
V13	Measure team members' satisfaction regularly			.643	
V14	Have clear strategic objectives				.670
V15	Seize opportunities and put them into practice				.660
V16	Have transformational leadership ability				.719
Variance		21.96%	19.29%	17.04%	16.31%
Internal reliability		.886	.889	.799	.859
Kaiser-Meyer-Olkin Measure of Sampling Adequacy (KMO): 0.916					
Bartlett's Test of Sphericity:					
Approx. Chi-Square: 1176.187					
Df: 120					
sig: 0.000					

To further compare the importance of these factors, the significant score is calculated as follows:

$$M_i = \frac{\sum_{j=1}^n V_{ij}}{n}$$

Where M_i is the significant score. V_{ij} is the mean of the j th variable within the groups. The order of these factors can be seen in Table 5.

Table 5: Significant scores of OIC factors

No.	OIC factors	Description	Significance scores (ranking)
1	Entrepreneurship	Have clear strategic objectives	5.93 (1)
		Identify opportunities and put them into practice	
		Have transformational leadership ability	
2	Organisational learning and communication	Achieve personal mastery	5.65 (2)
		Devote effort to learn from each other	
		Maintain communication openly with external resources	
		Establish good communication network	
		Have good corporation with partners	
3	Organisation career management	Carry on inspiration	5.63 (3)
		Make good career planning	
		Measure team members' satisfaction regularly	
4	Innovation culture	Have the willingness to change	5.46 (4)
		Promote incentive policy	
		Support for trying and innovative ideas	
		Spend time learning new things	
		Have regular team member training	

4. DISCUSSIONS AND SUGGESTIONS

The ranking of OIC's factors are shown in Table 5. Entrepreneurship plays the most crucial role in enabling innovation developments. It also conforms to theories and the reality. Organisational learning and communication together with organisational career management take the second place. There are no significant differences between these scores. Innovation culture is in the last place but the score is also higher than 4. The severity of these OIC factors is shown through grouping and comparing all these variables. Based on these results, suggestions can be offered for construction organisations to manage OIC:

- Bring leaders' responsibilities into full play
As suggested, entrepreneurship takes the leading role for OIC in construction organisations. Responsibility should be taken by leaders to promote innovation. Transformational leaders raise the performance expectations and intrinsic motivation of creation of their followers (Gumusluoglu & Ilsev, 2007). The encouragements and intellectual stimulation brought from leaders are irreplaceable. Certain types of leadership abilities mentioned need to be trained to seize opportunities in time. They should be the one to evaluate the benefits, risks and consequences of organisational innovation. Similar beliefs should be shared first within the leadership team as organisations' development relies on the wisdom of their strategies making.
- Increase level of communication and group learning
The pace of organisational innovation is decided by the ability to manage knowledge and information. A knowledge centre should be established in construction organisations (Cheung et al., 2015). No-boundary learning improves the chance to innovate and cooperate with other employees. Also, effective innovation is associated with widespread face to face communication between members (Monge et al., 1992). Higher level group participation also enhances OIC. New ideas can also be generated to improve project and organisational performance. For construction organisations, the construction technology and management mode have continuously improved, constant learning helps to adapt the new environment and promote better development of these organisations.
- Develop organisation career management to attract and retain talents
Career planning make the future foreseeable for many employees, mobilize the enthusiasm for work and increase their satisfaction (Prajogo & Ahamed, 2006). Compared with other products, construction projects usually take comparatively long time. Many of the employees need to participate in the whole project life cycle. Systematic career planning helps achieve personal mastery (Senge, 2006) and retain talents. Stable human resources reduce the time cost of training, make management more efficient, and increase possibilities for organisational improvement.
- Integrate innovation into organisation culture
This is the environment created for innovation. It contains necessary strategies and supports. There should be room and space for fostering OIC. First, the leader shall the willingness to change (Amabile, 1996). It is the base of establishing an innovative organisation. Besides, well-planned incentive polices motivate the enthusiasm to innovate. Reasonable time and money should be offered for creating new ideas. Take the construction project as a unit to implement different creative ideas. The successful experiences can be learnt from in many other construction projects.

OIC mainly focuses on cultivating the ability and creating the environment for people to innovate. For construction organisations, they should also integrate their own characteristics to make full use of this framework. It should be noticed that as the environment changes and the technology develops all the time. Fostering OIC is not one-off or ad hoc endeavour. It needs to be adjusted based on different market situation, culture background, cooperation styles and organisational scales.

5. CONCLUSIONS

The study posits to 1) explore constructs of OIC; 2) identify the significant facilitators of OIC and 3) suggest ways to enhance OIC. For these purposes, some OIC facilitators are summarized through the study of literatures. There are 16 facilitators concluded from previous studies. A questionnaire is set based on these facilitators. 102 construction professionals responded to this investigation. The ANOVA test shows there are no significant differences between different contracting organisation types and job positions. The data is further analysed by using EFA method. The result shows that all these facilitators can be divided into four groups. To further validate their significance, the significant scores is calculated for each groups. The ranking order is: 1) entrepreneurship; 2) organisational learning and communication; 3) organisation career management and 4) innovation culture. Based on the result of data analysis, some suggestions are put forward for construction organisations. They are: 1) bring leaders' responsibilities into full play; 2) increase level of communication and group learning; 3) develop organisation career management to attract and retain talent and 4) integrate innovation into organisation culture. It should be recognized that improving OIC is a continuous procedure and all these implications should be integrated to the characteristics of specific construction organisations.

6. REFERENCES

- Amabile, T.M. (1996) "Creativity and innovation in organisations", Harvard Business School
- Arad, S. & Hanson M.A. (1997) "A framework for the study of relationship between organisational characteristics and organisational innovation, *The Journal of Creative Behaviour*, Vol 31, 42-58
- Armbruster, H., Bikfalvi, A., Kinkel, S. & Lay, G. (2008) "Organisational innovation: The challenge of measuring non-technical innovation in large-scale surveys", *technovation*, 28, 644-657.
- Asad, S., Fuller, P., Pan, W. & Dainty, A.R.J. (2005) "Learning to innovate in construction: A case study", *Association of researchers in construction management*, Vol. 2, 1215-1224.
- Ball, M., Farshchi, M. & Grilli, M. (1999) "Competition and the persistence of profits in the UK construction industry, *Construction Management and Economics*", *Construction Management and Economics*, Vol 18, 733-745.
- Battisti, G., & Stoneman, P. (2010) "How innovative are UK firms? Evidence from the fourth UK community innovation survey on synergies between technological and organisational innovations", *British Journal of Management*, Vol 21, 187-206.
- Brynjolfsson, E. & Hitt, L.M. (2000) "Beyond computation: information technology, organisational transformation and business performance", *The Journal of Economic Perspectives*, Vol. 14 (4), 23-48.
- Camisón, C. & Villar-López, A. (2010) "An examination of the relationship between manufacturing flexibility and firm performance: The mediating role of innovation", *Journal of Business Research*, Vol. 30 Iss: 8, 853 - 878
- Chen, H.L. (2014) "Innovation stimulants, innovation capacity, and the performance of capital projects", *Journal of business economics and management*, Vol.15 (2), 212-231.
- Cheung, S.O. & Chan, K.Y. (2015) *Construction innovations in Hong Kong: a catalogue*, Construction Dispute Resolution Research Unit, Dept. of Architecture and Civil Engineering, City University of Hong Kong, Hong Kong.

- Cheung, S.O., Wong, S.P. & Yiu, T.K. (2015) *The soft power of construction contracting organisations*, Routledge, Abingdon, Oxon; New York, NY.
- Chinowsky, P., Molenaar, K. & Realph, A. (2007) "Learning organisations in construction", *Journal of management in engineering*, 10.1061/(ASCE) 0742-597X (2007)23:1(27), 27-34.
- Dobni, C. B. (2008) "Measuring innovation culture in organisations: The development of a generalized innovation culture construct using exploratory factor analysis", *European Journal of Innovation Management*, Vol. 11 Iss 4, 539 - 559
- Damanpour, F. (1991) "Organisational innovation: a meta-analysis of effects of determinants and moderators", *The Academy of Management Journal*, vol.34, No.3, 693-716.
- Damanpour, F., & Aravind, D. (2011) "Managerial innovation: Conceptions, processes, and Antecedents", *Management and Organisation Review*. <http://dx.doi.org/10.1111/j.1740-8784.2011.00233.x>.
- García-Morales, V. J., Llorens-Montes, F. J. & Verdú-Jover, A. J. (2006) "Antecedents and consequences of organisational innovation and organisational learning in entrepreneurship", *Industrial Management & Data Systems*, Vol. 106 Iss 1, 21 - 42.
- García-Morales, V. J., Jiménez-Barrionuevo, M.M. & Gutiérrez-Gutiérrez, L. (2012) "Transformational leadership influence on organisational performance through organisational learning and innovation ", *Industrial Management & Data Systems*, Vol. 106 Iss 1, 21 - 42.
- Gera, S. & Gu, W. (2004) "The effect of organisational innovation and information technology on firm performance", *International Performance Monitor*, No.9
- Gumusluoglu, L. & Ilsev, A. (2009) "Transformational leadership, creativity, and organisational innovation", *Journal of Business Research*, Vol.62, 461-473.
- Hair, J. F., Anderson, R. E., Tatham, R. L. & Black, W. C. (2008) *Multivariate data analysis*, Prentice Hall.
- Junga, D.I., Chowb, C. & Wu, A. (2003) "The role of transformational leadership in enhancing organisational innovation: Hypotheses and some preliminary findings", *The Leadership Quarterly*, Vol.14, 525-544.
- Kimberly, K.R. & Evanisko, M. J. (1981) "Organisational Innovation: The Influence of Individual, Organisational, and Contextual Factors on Hospital Adoption of Technological and Administrative Innovations", *The Academy of Management Journal*, Vol. 24, No. 4, 689-713.
- Kodama (1999) "Strategic innovation at large companies through strategic community management – an NTT multimedia revolution case study", *European Journal of Innovation Management*, Vol. 2(3): 95-108.
- Larsson, J., Eriksson, P.E., Olofsson, T. & Simonsson, P., (2015) "Leadership in Civil Engineering: Effects of Project Managers' Leadership Styles on Project Performance", *Journal of management in engineering*, 10.1061/(ASCE) ME.1943-5479.0000367.
- Li, Y. (2009) "Research on project group human resource allocation of construction enterprise", *College of Mechanical Engineering of Chongqing University*.
- Moch, M. K. & Morse, M.E. (1977) "Size, Centralization and Organisational Adoption of Innovations", *American Sociological Review*, Vol. 42, No. 5, 716-725
- Monge, P. R., Cozzens, M.D. & Contractor N.S. (1992) "Communication and Motivational Predictors of the Dynamics of Organisational Innovation", Vol. 3, No. 2, 250-274.
- Pedler, M., Burgogyne, J. & Boydell, T. (1997) *The Learning Company: A strategy for sustainable development*. 2nd Ed. London; McGraw-Hill.
- Porter, M.E. (1990), *The Competitive Advantage of Nations*, Harvard business review.
- Prajogo, D.I. & Ahmed, P.K. (2006) "Relationships between innovation stimulus, innovation capacity, and innovation performance", *R&D Management*, 36 (5), 499-515.
- Senge, P.M. (2006) *The Fifth Discipline: The art and practice of learning organization*, Crown Pub..
- Schwartz I.S. & Bear D.M. (1991) "Social validity assessments: is current practice state of the art?", *Journal of applied behavior analysis*, Vol. 2, 189-204.
- Sharma, S. (1996) *Applied multivariate techniques*, John Wiley & Sons, Inc.
- Tidd, J., Bessant J. & Pavitt, K. (2001) "Why study national systems and national styles of innovation?", *Journal of technology analysis & strategic management*, Vol. 10 (4), 407-422.
- OECD (2005) *Science and innovation policy: Key challenges and opportunities*. OECD Publications Service.

W70: FACILITIES MANAGEMENT AND MAINTENANCE

POTENTIAL EFFECTS OF TECHNOLOGICAL INNOVATIONS ON FACILITIES MANAGEMENT PRACTICE

U.J. Adama and K.A. Michell

*UCT–Nedbank Urban Real Estate Research Unit, Department of Construction Economics and Management,
University of Cape Town, Private Bag X3, Rondebosch, 7701, South Africa*

Email: ADMUNE001@myuct.ac.za

Abstract: Advancement in technology innovations, which is necessitated by globalisation has transformed the practice of facilities management (FM). Consequently, cutting edge technologies, including the drone technology, robots, sensors, cloud-based technology and the internet of things have become common tools that facilities managers adopt to achieve value addition in organisations. The adoption of these technological innovations affects both the core business and the employees of the organisations. However, previous studies in this regard have tended to focus more on analysing technological innovations and the core business to the exclusion of the employees. This study seeks to explore the potential influence of technological innovation on the employees because technology in an organisation without the active creativeness of the employee will be incapacitated in service delivery. The study was explorative in nature using the literature as the starting point for evaluating the potential effects that technological innovations could have on the employees of organisations and the challenges faced in their respective implementation in organisations. To this end it is recommended based on the literature search that facilities managers should consider the potential impact of adopting technological innovations on the employees of the organisation.

Keywords: Employees, Facilities Management, Technological Innovations, Technology

1. INTRODUCTION

This paper explores how drones, robots, sensors, cloud-based technologies, and the internet of things have transformed the operations of organisations and the practice of FM. In addition, it will explore the implications that technological innovation has on the employees and therefore the social sustainability of the organisation. These technological innovations are the most commonly adopted in the built environment and the sophistication brought to the business by these technological innovations cannot be ignored by an organisation that seeks to remain competitive in the global economy. With the expanded scope of FM practice, from the micro level of the building unit where it is involved with the designing, construction and maintenance of buildings to the different support services like landscaping, fleet management, human resource management, and food services etc., the facilities manager cannot operate without the adoption of technological innovation as enabling work tools. Although there are studies on technological innovation in FM practice, they are mostly industry based, and motivated by profit maximisation and the need to meet shareholders demand, a posture which is at variance with the current state of FM development with increased interest in understanding the impact that FM makes on the community. Therefore, there is a paucity of scholarly study that evaluates the current trend of technological innovation in FM practice as it affects intricate factors like the employees and social sustainability.

One key success factor of any organisation is the state of the employees (Ngo and O' Cass, 2013). This is apparent because the success of organisation is driven by the creative minds of the employees (Prahalad and Ramaswamy, 2003). Although the adoption of technological innovations can stimulate success in an organisation, it is limited without the active

participation and creativeness of the employee (Bugshan, 2014; Lee, Olson and Trimi, 2012; Zhang *et al.*, 2015). This implies that without people, technology is incapacitated (Fairbank and Williams, 2001; Im and Workman, 2004; Lazarevic, 2012; Zhang *et al.*, 2015). However, previous studies on the adoption of technological innovations in organisations have been passive on the effect of the technology on the employees of the organisations. Ware *et al.* (2017) emphasised the need for facilities managers to understand how technological innovations will affect workforce productivity, innovation, and employment relationships on a sustainable basis. Hence, this study reviews emerging technological innovations in FM practice (drone, robots, sensors, cloud-based technology, the internet of things and social media), and how their influence on service delivery can be upheld by examining the employees and social sustainability in the organisation. The strategy of the study was first to examine the influence of the technological innovations on FM practices, then their implications on the employees and social sustainability.

2. EMERGING TECHNOLOGIES IN FM

2.1 Drone technology

They are also known as unmanned aerial vehicles (UAV). The benefits of using the UAVs include quick access, low cost, and the ability to document asset conditions in an automated fashion (Bobby, 2017). These benefits have attracted the attention of professional facilities managers to the use of drone technology in their maintenance and security operations. As the drone technology capabilities continue to advance in applicability, facilities managers are beginning to realise the benefits of using the drone to perform fundamental maintenance and security activities (Hounsell, 2016; Bobby, 2017). In FM, drone technology can be used to access problematic areas which technicians cannot safely reach or for which the cost of accessing such difficult locations by platforms and scaffolding will be expensive, in addition to the man-hour required to set up and take down scaffolding and the potential danger such areas posed to workers (Hounsell, 2016).

Drone technology allows field technicians to monitor equipment performance and obtain valuable details about critical assets at almost no risk (Bobby, 2017). With the aid of remote-controlled cameras mounted on the drone, it can transmit images of building structures, machinery on a rooftop, and general condition of roofs. Bobby (2017) further argued that drone technology can also provide infrared and X-ray images which can be used to identify structural issues or dangerous leaks in an environment which is potentially unsafe for humans to reach. In addition, to the exterior capabilities of drone, it can also be flown indoors subject to no regulations like the outdoor operations. Drone technology has several potential benefits for facilities managers as they assist in maximising the facilities lifecycle. However, Andrew Dennison, the chief operating officer with [Lift Technologies](#), an unmanned Aerial Vehicle (UAV) services company in Chicago in 2016 expressed that the benefits of drone technology have not been outlined to facilities managers. In his words:

“I don’t think a lot of them understand what they can get, and the drone operators really don’t understand what facility managers want. In six months to a year, as more of these conversations happen, they’ll start to get a better feel, and some new software services might help facility managers even more.”

The above statement indicates a significant gap in the knowledge of the facilities managers and the developers of drone technology. This call for an urgent need for collaboration between the facilities managers and the drone manufacturers with a view to manufacturing drones that help to leverage added-value in FM. There is a scarcity of academic literature in FM that addresses the use of drones, whereas there is a substantial amount of industry-based research centred on the use of drone technology in FM. There is a need for research that bridges the gap between practice and the academia concerning the advancement of these technological innovations in FM practice. Some of the questions that are begging for answers includes: what are the common and beneficial facilities applications for drone technology? What regulations governs the use of drones in FM? What specific criteria should be adopted for drone service providers to address FM specific needs? And how can the data from drone services be managed in a way that translates into tangible benefits for organisations? (Petermann, 2016).

Furthermore, other challenges confronting the use of drone technology for FM operations include the high costs associated with the flying a drone and the need for collaboration with the aviation industry (Dennison, 2016). For instance, Dennison (2016) argues that the records of the flight path of the drone need to be available and defined before any flying operation. Some challenges which are of a technical nature, like weather conditions and the strength and clarity of the GPS signals are all considerations that would confront their effective integration into FM practice globally. Dennison (2016) further argues that specifically, the weather condition is critical for a successful flight operation because certain level of rain intensity and wind velocity affects the effectiveness of drone flights. There is also the issue of interference with compass readings and signals when flying close to large metal objects. These are some of the challenges that the facilities managers should be at the forefront of proffering solutions to in organisations.

2.2 Robots

Robots are adopted for a variety of workplace applications in FM. For instance, robots are adopted for portering, maintenance and customer care services (Tanya and Anandan, 2015). In the health care sector, where robots are deployed as porters, there is a marked reduction in crowdedness in hospital corridors by nurses and relatives of patients (Outsourced Client Solutions, 2016). Also, improved efficiency and productivity of nurses who are no longer engaged in the portering services have been noticed. Furthermore, robots in the hospitals have greatly reduced the risk of spreading infectious diseases, and promoted patient's privacy and dignity. In maintenance operations, facilities managers have increased automation of services like cleaning, floor scrubbing, vacuum operations, and grass cutting. Due to the level of noise associated with vacuuming and scrubbing or mopping, they are preferably done at night outside normal office hours, so as not to disrupt conversations and meetings that are conducted in the normal working hours. This traditionally required that lights and heat or air-conditioning be turned on, and a cleaning staff engaged to work at night (Goossens, 2016). However, with the adoption of robots, cleaning services and energy efficiency are enhanced as automated cleaning does not require lighting or heating. Moreover, robots are more effective, and present less risk, compared to their human counterparts especially when cleaning windows in high-rise buildings and when there is challenge of access in small spaces (Goossens, 2016).

Robots are increasingly being deployed for waste management in light of the increasing tonnage of waste generation. The UK government's statistics indicated that 24% or approximately 48 million tons of the UK's total waste in 2012 was from commercial and

industrial activities. This represents a significant volume of waste to be processed by human beings. However, with the deployment of robotic waste sorting systems, which operate using a combination of machine learning technology and range of sensors, an uninterrupted 24 hours waste management operations is possible. The robots sorted wastes at higher rate of efficiency and were more cost effective than human operated waste handlers. Robots are also engaged by facilities managers in the provision of security and safety services. This has reduced cost and improved operational efficiency, especially for facilities managers who are responsible for management of large portfolios. Robots are usually deployed to help carry out scheduled environmental sampling protocols, conduct regular safety checks, inspect and report hazard risks, and respond to an emergency.

2.3 Sensors

Sensors are increasingly used to detect or measure physical properties and records, or otherwise respond to circumstances where necessary. In the built environment, sensors are basically differentiated into two, namely: infrastructure sensors; and occupant-related sensors. The former is basically used for monitoring powerlines and equipment, while the latter is installed in building facilities to monitor the climate, lighting, safety, security, etc. (Roth, 2017). From an FM point of view the latter type of sensors have a significant impact on practice. When smart sensors are installed in building facilities, the operating costs are reduced, productivity is enhanced, and the occupants' comfort is improved (Roth, 2017). According to Michael Isenberg, a senior associate of building mechanical systems, quoted in Millán (2014), smart sensors like wireless occupancy sensors, daylight sensors, audio/visual sensors, temperature sensors, carbon dioxide sensors, and door access controls are adopted for adequate space management and utilisation, effective energy savings, security and safety management. With the widening scope of FM into human resource management, the use of sensors becomes vital. For instance, in an organisation, a smart sensor can be used to collect detailed information about occupants' presence, location, count, and activities, the data collected can be used to plan the optimisation of FM with respect to hot desking, meeting room bookings, space planning, and energy savings (Yerby, 2013; Roth, 2017). The growing adoption of wireless solutions like sensors is attributed to the increased collaboration and merging of the traditional silos between FM, IT and engineering, despite the majority of the data from sensors are currently not fully optimised for added-value (Millán, 2014). This is attributed to the fact that the data from sensors are currently only being used to detect and control anomalies (Millán, 2014). Hence, there is a need for full optimisation by way of predicting outcomes based on the information from the various data sources to achieve greater value addition in the organisation. Greater value can be derived from data generated from technological innovations if they are presented in a useful and actionable format that the facilities managers can use for predictive maintenance schedule.

2.4 Cloud-based technology

Cloud-based technology has been described by researchers and industry experts differently. For instance, Lau *et al.* (2013, p.2) define the cloud "as a distributed system that can unify resources scattered across various locations and make one or more available to a user on demand". Buyya *et al.* (2008, p.6) define cloud computing as "on-demand provisioning of software, hardware and data as a service". This involves the relying on global applications rather than enterprise application and significant knowledge sharing rather than in-house

expertise. In the context of FM, cloud computing presents an opportunity for unification of the management of facilities in multiple geographically dispersed locations (Lau *et al.*, 2013). This will minimise the prohibitive cost of managing the computer infrastructure in many locations, provide unlimited access to specialised software and the latest updates, and since the cloud is composed of multiple servers and data storage units, failure of a piece of hardware does not prevent the use of the software and data (Lau *et al.*, 2013). For instance, before the advent of cloud technology, FM organisations that have their portfolios scattered in different locations struggled with keeping their running costs low, but cloud technology supports organisations to centrally monitor, control and manage all their portfolios from a single location at an affordable cost.

Some of the capabilities that have been enhanced in FM practice due to use of the cloud-based technology are: the constant improvement to facilities performance because of constant monitoring of building operations with respect to energy use and costs comparison across portfolios for possible area of improvement. Cloud based technology has also facilitated an ability to be proactive in maintenance strategies as problems are identified and resolved promptly. In addition, cloud based technology has enhanced the facilities manager's ability to ensure better occupants' comfort because the conditions of facilities can be continuously monitored on a real-time basis. It has also enabled the availability of real-time alerts about unexpected malfunctions or out-of-specification conditions within buildings and thereby facilitated a prompt response and turnaround time. Hence, the cloud technology has enabled an overall improvement in service delivery on the part of the facilities manager.

2.5 The internet of things

The internet has revolutionised the practice of FM. The internet enables the use of email, instant messaging, laptops, and mobile phones, which are among the technologies that organisations adopt for flexible work schedules (Hoeven *et al.*, 2016). From the FM point of view, facilities managers can carry out their functions from any remote location without necessarily visiting the site through video conferencing, multimedia instant messaging, recording and photographing, using the smartphones and social media technologies enabled by the internet. This has helped to streamline organisation processes and enhanced the productivity of managers because of the online real time communication with their employees. Also, the employees can communicate more efficiently, by obtaining and responding to information and queries promptly via the internet (Long, 2016). The internet technology equally supports and promotes different work styles like, flexible work arrangements, open-office environments, telecommuting schedules, compressed work weeks, and teleconferencing facilities (Brough and O'Driscoll, 2010; McElroy and Morrow, 2010; Leslie *et al.*, 2012; Golden, 2013; Hing Lo, *et al.*, 2014; Gajendran *et al.*, 2015).

3. IMPLICATIONS FOR EMPLOYEES

Technology has become an indispensable tool for all organisations including FM in the globalised economy (Peppard and Ward, 2004). However, Ebbeson (2015) and Kandampully *et al.* (2016) argued that not all organisations derive competitive advantage through technology because the added-value that technology offers depends on a variety of factors that involves the employees. Therefore, an assessment of the impact of technology on the employee, given the significant investment and expected opportunities in technological innovations, cannot be

out of place (Nyheim and Connolly, 2011; Bilgihan, Okumus and Cobanoglu, 2013; Kauffman, Liu and Ma, 2015). This section examined the implication that each of the technological innovations have on the employees.

Robots are rapidly replacing employees in most jobs (Nakagawa 2015; West, 2015). For instance, West (2015) argued that with the aid of technological innovation, many organisations have achieved economies of scale with few employees. West (2015) further writes that Google, which was worth \$370 billion in 2014 only had about 55,000 employees which is less than a tenth of the size of American Telephone and Telegraph (AT&T) workforce in 1960s due to technological innovations. Also, most of the robots are fitted with capabilities that further forecloses the need for human assistance like self-recharging capabilities. This enables the robots to automatically recharge themselves when they experience a drop in their battery level to 60% without needing human supervision. These smart robots help in reducing overheads on labour. Therefore, with increased adoption of robots in FM practice, job displacements at every level of FM is a given.

The adoption of sensors threatens the chances of survival of the tactical level of FM because most building fittings that are monitored by sensors will not require the supervisory role of the tactical level FM as the building fittings fitted with sensors are programmed to report any fault or out-of-specification conditions to the remote monitoring point. Sensors have also been attributed with the capacity for effective employee monitoring by which organisation can maximise employee's time and increase efficiency (Yerby, 2013; Roth, 2017). However, there are legal and ethical issues around employee monitoring which the facilities managers must prepare to grapple with as the adoption of sensors in organisations continue to rise, and employee privacy advocates continue to seek reforms for greater protection of the employees (Yerby, 2013).

The ability of the drone technology to access difficult and risky building areas holds a double implication for employees. While it translates to an improvement in the safety practice of FM because of the numerous deaths caused by falls from heights (Bobby, 2017), it also promotes huge job loss in the scaffolding services of operational FM (Hounsell, 2016). With the advancement of the internet, scholars and professionals have recognised some unfavourable effects on employee well-being (Golden, 2013) especially during off-work hours and the subsequent impact on work-life balance (Hoeven *et al.*, 2016). Employees face social isolation, alienation, lack of organisational visibility, intrusion of work into home life and overwork as a result of some forms of technological innovation (Grimshaw, 2007).

4. IMPLICATIONS FOR SOCIAL SUSTAINABILITY

The Brundlandt Commission defined sustainable development as “development which meets the needs of the present without comprising the ability for future generations to meet their own needs” (WCED 1987, p.43). It can be argued that the use of the term “needs” in the Brundtland definition of sustainability, summarises the interplay of society and nature (Littig, and Grießler, 2005). If “needs” is analysed in the context of paid employment, then employment will allow the people to meet their needs. Employment in the broadest sense plays an essential role in sustainability because of the ability to fulfil basic needs that the employees derive. However, gainful employment is one of the foremost organisational and structural principles of society, which has continued to experience transformation over time (Fischer-Kowalski and Haberl, 1993). Employment in modern working societies, especially paid employment, has

transformed beyond ensuring that people have access to a livelihood to satisfy their needs, towards becoming the means of stratifying and structuring society (Senghass-Knoblauch, 1998). Hence, paid employment is regarded as a factor of social sustainability that mediates the nature-society relationship, because it is the way by which an extended set of human needs are met and the society's reproductive capabilities are upheld (Littig, and Grießler, 2005). Furthermore, it is expected that the concept of social sustainability in an organisation reflect elements of social welfare (DIW *et al.*, 2000; HBS 2001; Brandl and Hildebrandt, 2002) that not only secure employees' income but also promotes integration and social cohesion (Senghass-Knoblauch, 1998). The implication of increased digitisation in FM has affected employment as seen from the earlier literature on the technological innovations. Consequently, it may be argued that if employment is a factor of social sustainability, and it is significantly affected by technological innovations in FM, then there is need to evaluate our sustainability practice in the face of technological advancement.

5. DISCUSSION

FM has grown over time from the cost cutting level to the stage of measuring the impact of its activities on the society. However, the impact of technological innovation appears to be at variance with the growth in FM profession. Adoption of technological innovations in FM has continued to be aligned with the streamlining of business processes and the management of cost efficiency (Becker, 1990; Alexander, 1992; Alexander, 1994; Price, 2000; Pitt and Hinks, 2001). This is reminiscent of the first generation of FM practice when the profession was working in isolation to the organisation (Pathirage *et al.*, 2008). There is a narrow view of technological innovation capability in FM because issues that are fundamental to the management of the facility beyond cost optimisation are not considered (Dommelin *et al.*, 1990). There appears to be a contention between the effects of technological innovation in FM and the current state of development of FM practice. While the technological innovations are streamlining business processes and cutting costs through job losses, FM has grown to the level of measuring how its operations impact society. Moreover, the information that is generated from the use of technology, just like the first generation of FM cannot be really optimised towards predicting value addition in the organisations. Therefore, there is a need for a broader perspective of FM strategy and operation when considering the adoption of technological innovations where the integration of people, process, and place will be the utmost consideration (Rondeau *et al.*, 1995; Alexander, 1996; McGregor, 2000) and the consideration of the impact of FM activities beyond the micro level of the building to the macro level of the society will be paramount (Price, 2002; Alexander and Brown, 2006; Michell, 2013).

6. CONCLUSION

Technological innovation has shaped FM practice greatly. However, there is a need to constantly evaluate and align its impact with the current level of development in the profession, not forgetting the fundamental principles of integrating people, place, process and technology. This will require the academicians to research into some of the contemporary challenges that have come up with the use of technology. Especially as it relates with the employees to have a holistic perspective that is not only profit driven but socially sustainable. This paper represents a preliminary study of an ongoing research in this regard.

7. REFERENCES

- Alexander, K. (1992). Facilities management in the new organisation. *Facilities*, 10(1), pp. 6-9.
- Alexander, K. (1994) A Strategy for facilities management. *Facilities*. 12(11), pp.6-10.
- Alexander, K. (Ed.). (1996) *Facilities management: Theory and practice*. London: E & FN Spon.
- Alexander, K. and Brown, M. (2006). Community-based facilities management. *Facilities*, 24(7/8), pp. 250-268.
- Becker, F. (1990). *The Total Workplace: Facilities Management and Elastic Organisation*, Preager Press, New York, NY.
- Bilgihan, A., Okumus, F., and Cobanoglu, C. (2013) Generation Y travelers' commitment to online social network websites. *Tourism Management*, 35, pp.13-22.
- Bobby, W. (2016) Drones and the emergence of unmanned asset management. from Facilityexecutive.com <https://facilityexecutive.com/2017/02/drones-emergence-of-unmanned-asset-management/>
- Brandl, S. and Hildebrandt, E. (2002) Zukunft der Arbeit und soziale Nachhaltigkeit, Zur Transformation der Arbeitsgesellschaft vor dem Hintergrund der Nachhaltigkeitsdebatte, Leske und Budrich, Opladen.
- Brough, P., and O'Driscoll, M. P. (2010) Organizational interventions for balancing work and home demands: An overview. *Work & Stress*, 24, 280-297.
- Buyya, R., Chee Shin, Y. and Venugopal, S. (2008) Market-oriented cloud computing: vision, Hype, and reality for delivering IT services as computing utilities. Proceedings of the 10th IEEE International Conference on High Performance Computing and Communications, 25-27 September, Dalian, Available at: <http://arxiv.org/abs/0808.3558> (15/03/2017).
- Bugshan, H. (2014) Co-innovation: The role of online communities. *Journal of Strategic Marketing*, 1-12. ahead-of-print.
- DIW (Deutsches Institut für Wirtschaftsforschung), WI (Wuppertal Institut für Klima, Umwelt, Energie) and WZB (Wissenschaftszentrum Berlin) (2000) Verbundprojekt Arbeit und Ökologie, Projektabschlussbericht, HBS (Hans-Böckler-Stiftung) (Ed.), Düsseldorf.
- Ebbesen, P. (2015). Information Technology in Facilities Management - A Literature Review. In K. Alexander, & I. Price (Eds.), *Research Papers. Advancing Knowledge in Facilities Management: People make Facilities Management EuroFM*. (EuroFM Research Papers).
- Fairbank, J. F., and Williams, S. D. (2001). Motivating creativity and enhancing innovation through employee suggestion system technology. *Creativity and Innovation Management*, 10(2), pp.68-74.
- Fischer-Kowalski, M. and Haberl, H. (1993) Metabolism and colonisation: modes of production and the physical exchange between societies and nature. *Innovation in Social Science Research*. 6, pp.415-442.
- Goossens, B. (2016) Using Robots for Building Maintenance. Available from: <http://www.buildings.com/buzz/buildings-buzz/entryid/297/using-robots-for-building-maintenance> [Accessed 16/04/ 2017].
- Grimshaw, B. (2007). History is bunk: Considerations on the future of FM. *Facilities*, 25(11/12), pp.411-417.
- HBS (Hans Böckler Stiftung) (Editor) (2001) Pathways to a Sustainable Future. Results from the Work and Environment Interdisciplinary Project, Düsseldorf.
- Hounsell, D. (2016) Managers strive to learn benefits of drone technology. Retrieved from <http://www.facilitiesnet.com/maintenanceoperations/article/Managers-Strive-to-Learn-Benefits-of-Drone-Technology-Facility-Management-Maintenance-Operations-Feature-16439>.
- Gajendran, R. S., Harrison, D. A., and Delaney-Klinger, K. (2015) Are telecommuters remotely good citizens? Unpacking telecommuting's effects on performance via I-deals and job resources. *Personnel Psychology*, 68, pp.353-393.
- Golden, A. G. (2013) The structuration of information and communication technologies and work-life interrelationships: Shared organizational and family rules and resources and implications for work in a high-technology organization. *Communication Monographs*, 80(1), 101-123.
- Hing Lo, S., van Breukelen, G. J. P., Peters, G. J. Y., and Kok, G. (2014) Teleconference use among office workers: An interorganizational comparison of an extended theory of planned behavior model. *Administrative Sciences*, 4(1), pp.51-70.
- Hoeven, C. L. T., van Zoonen, W. and Fonner, K. L. (2016) The practical paradox of technology: The influence of communication technology use on employee burnout and engagement. *Communication Monographs*, 83(2), pp.239-263.
- Im, S. and Workman, J. P., Jr. (2004) Market orientation, creativity, and new product performance in high-technology firms. *Journal of Marketing*, 68(2), pp.114-132.
- Kandampully, J., Bilgihan, A. and Zhang, T. (2016) Developing a people-technology hybrids model to unleash innovation and creativity: The new hospitality frontier. *Journal of Hospitality and Tourism Management*, 29, pp.154-164.
- Kauffman, R. J., Liu, J., and Ma, D. (2015) Technology investment decision-making under uncertainty. *Information Technology and Management*, 16(2), pp.153-172.

- Lau, D., Liu, J., Majumdar, S., Nandy, B., St-Hilaire, M. and Yang, C.S. (2013). A cloud-based approach for smart facilities management. In *Prognostics and Health Management (PHM), 2013 IEEE Conference on* (pp. 1-8). IEEE.
- Lazarevic, V. (2012) Encouraging brand loyalty in fickle generation Y consumers. *Young Consumers: Insight and Ideas for Responsible Marketers*, 13(1), pp.45-61.
- Lee, S. M., Olson, D. L., and Trimi, S. (2012) Co-innovation: Convergenomics, collaboration, and co-creation for organizational values. *Management Decision*, 50(5), pp.817-831.
- Leslie, L. M., Manchester, C. F., Park, T. Y., and Mehng, S. A. (2012) Flexible work practices: A source of career premiums or penalties? *Academy of Management Journal*, 55, pp.1407-1428.
- Littig, B., and Griebler, E. (2005) Social sustainability: a catchword between political pragmatism and social theory. *International journal of sustainable development*, 8(1-2), pp.65-79.
- Long, N. (2016) *How technology affects job performance*. Retrieved from <http://smallbusiness.chron.com/technology-affects-job-performance-13463.html> 12/02/2017
- McElroy, J. C., and Morrow, P. C. (2010) Employee reactions to office redesign: A naturally occurring quasi-field experiment in a multi-generational setting. *Human Relations*, 63, pp.609-636.
- McGregor, W. (2000) Preparing for an uncertain future. *Facilities*, 18 (10-12), pp.402-10.
- Michell, K. (2013) Urban facilities management: a means to the attainment of sustainable cities? *Journal of Facilities Management*, 11(3).
- Nakagawa, D. (2015) The Second Machine Age is Approaching. Huffington Post, February 24, 2015.
- Ngo, L. V., and O'Cass, A. (2013) Innovation and business success: The mediating role of customer participation. *Journal of Business Research*, 66(8), pp.1134-1142.
- Millán N. (2014) Popularity and benefits of wireless systems and sensors are growing. Available from <http://www.facilitiesnet.com/buildingautomation/article/Popularity-And-Benefits-Of-Wireless-Systems-And-Sensors-Are-Growing-Facilities-Management-Building-Automation-Feature--15477>. Accessed 12/4/2017.
- Nyheim, P., and Connolly, D. (2011) *Technology strategies for the hospitality industry*. Prentice Hall Press.
- Outsourced Client Solutions (2016) Rise of the robots how increased automation in facilities management is benefitting businesses. Available from <http://www.ocs.co.uk/blog/post/06/2016/rise-of-the-robots-how-increased-automation-in-facilities-management-is-benefitng-businesses>, accessed on 27/4/2017
- Pathirage, C., Haigh, R., Amaratunga, D. and Baldry, D. (2008) Knowledge management practices in facility organisations: a case study. *Journal of Facilities Management*, 6 (1), pp.5-22.
- Peppard, J. and Ward, J. (2004) Beyond strategic information systems: Towards an IS capability. *The Journal of Strategic Information Systems*, 13(2), pp.167-194.
- Prahalad, C. K., and Ramaswamy, V. (2003) New frontiers in experience innovation. *Sloan Management Review*, Vol. Summer pp.12-18.
- Price, I. (2000) From outputs to outcomes: FM and the language of business. in Then, D.S.S. (Ed.), *Proceedings of the WIB70 Conference*, Brisbane, Australia.
- Price, I. (2002) Can FM Evolve? If not what future? *Journal of Facilities Management*, 1(1) 56-70.
- Pitt, M. and Hinks, J. (2001) Barriers to the operations of the facilities management. *Facilities*, 19(7/8), pp.304-307.
- Rondeau, P. (1995) *Facility Management*. (2nd edition) New York: John Wiley and Sons Inc.
- Roth, I. (2017) Facility management is facilitated by smart sensors. Retrieved 13/04/2017 <https://facilityexecutive.com/2017/01/facility-management-facilitated-smart-sensors/>
- Senghaas-Knobloch, E. (1998) Von der Arbeits- zur Tätigkeitsgesellschaft? Politikoptionen und Kriterien zur ihrer Abschätzung' *Feministische Studien*, Vol. 16(2), pp. 9-30.
- Tanya and Anandan, (2015) robots and healthcare saving lives together. https://www.robotics.org/content/detail.cfm/industrial-robotics-industry-insights/robots-and-healthcare-saving-lives-together/content_id/5819. Accessed on 22/04/2017.
- van Dommelen, D., Noordegraaf, R. and Buma, H. (1990) Decision making in a strategic approach to facilities management. *Facilities*, 8(9), pp.12-16.
- West, D. M. (2015) What happens if robots takes the jobs? The impact of technologies on employment and public policy.
- Yerby, J. (2013) Legal and ethical issues of employee monitoring. *Online Journal of Applied Knowledge Management*, 1(2), pp.44-55.
- Zhang, T., Kandampully, J., and Bilgihan, A. (2015) Motivations for customer engagement in online co-innovation communities (OCCs): A conceptual framework. *Journal of Hospitality and Tourism Technology*, 6(3), 311-328.

PREVALENCE OF FACTORS AFFECTING MAINTENANCE MANAGEMENT OF PRISON FACILITIES IN SOUTH-WEST, NIGERIA.

O. O. Ajayi, J. Faremi and O. A. Adenuga

Department of Building, Faculty of Environmental Sciences, University of Lagos, Nigeria

Abstract: The prevalence of diverse factors affecting maintenance management determines the impact of such factors on the maintenance of prison facilities. This study investigates factors that affect the maintenance management of prison facilities in South-West, Nigeria. Questionnaires were used to collect data from the prison staff in the maintenance unit of all prisons situated in South-west, Nigeria. The statistical tools employed for the study were percentage, mean scores, kendall's coefficient of concordance test of agreement. Result showed that deterioration due to age of facilities, overcrowding, inadequate plant and equipment for maintenance operations as well as inadequate training and development for prison maintenance staff are critical underlying factors. This result enabled the maintenance unit to identify the predominance factors. The study acknowledged the predominance barriers to implementation of satisfactory maintenance management. For better management of maintenance of prison facilities; study recommends that the government should provide all necessary maintenance and capital resources. Such as sufficient maintenance budgets, plant and equipment for maintenance operations and enabling policies that would ensure functionality of prison facilities.

Keywords: Factors, Maintenance Management, Prevalence, Prison Facilities, Prison Staff.

1. INTRODUCTION

Nigerian prisons service operations

The Nigerian prison service operates under CAP 366 Law of the Federation of Nigeria 1990 to keep in custody those certified to be kept by courts of competent jurisdiction, to identify the causes of their anti-social dispositions and provide treatment and training to allow for integration of such into society after release (www.prisons.gov.ng/organogram/work.php). Prison facilities are to provide a safe and decent environment for prison staff and prisoners to work and live in, as well as for all others who interact with the prison facilities (Prison Service Technical Order [PSO] 5900 & 5901). Beyond these functions, prison facilities are to create an environment that supports the prison service objectives. That is, reformation, correction and rehabilitation of prisoners. To sustain these functions it becomes imperative for the Nigerian prison service to put in place a structured maintenance management system. That is capable of providing the right tools, equipment, maintenance materials, technologies, manpower (Pun, Chin, Chow and Lau 2002) and methodologies of carrying out maintenance activities on prison facilities.

This structured maintenance management optimises the use of available maintenance resources. It involves the utilisation of manpower to attain the desired objectives of keeping the prison facilities in a safe condition and avoid the need for potential expenses and disruptive repairs which may damage the facilities (Pun, et al. 2002; Sodangi, Khamdi, Idrus, Hammad and Umar, 2014). However, there are factors that militate against the maintenance management of the Nigerian prison facilities.

2. LITERATURE REVIEW

Like any other establishment, the Nigerian prisons service should perceive maintenance management as an essential function classified as non-core activities that support its core (rehabilitation and reformation) business (Siu, Bridge and Skitmore 2001). Institutional facilities should be managed and maintained properly to ensure the functioning of the facilities and to reduce maintenance cost by carrying out an appropriate maintenance programme that could extend the life cycle of facilities while providing a safe environment for the users (Abdullah Sani, Mohammed, Misnan and Awang 2012; Hamzah and Kobayashi 2013).

Agomoh and Oghozor's (2006) assessment of the Nigerian prison system revealed that the system has failed in security, reformation, rehabilitation, re-integration and revenue generation. It appears these failures could be associated with the state and availability of the prison facilities to perform the functions for which it is designed, used or required to be used. In the year 2008, the Minister of Internal Affairs, during the inauguration of Suleja Prisons, disclosed the Federal Government's intention to undertake a massive reform of the nation's prison system in a bid to address the observed decadence and to improve prison facilities across the Country. Such decadency in prison facilities affects the inmates whereby they are exposed to developing sick building syndrome (itchy skin, headaches, stuffy nose etc.) due to low level of inmates control over ventilation, poor standard of cleanliness and lack of repairs in the cell blocks (Health and Safety Executive [HSE] 2000) and the maintenance of the facilities.

Prison facilities maintenance is not being carried out according to actual maintenance needs due to poor funding on the part of relevant authority. This has serious implications for economic and social development (Yahaya 2012). Zubairu (1999) affirms that maintenance problems have been worsened by the uncaring attitude of users of public facilities having an impression that the maintenance of public facilities is the sole responsibility of the government. The conditions of sanitary and sewage facilities impede the health of the inmates (PRAWA 2000). Poor prison facilities, structural failure of facilities, and inadequate security features are most likely or could most time result in prison break as evident in the Nigerian prisons. Several cases of prison breaks have been reported between 2009 and 2014. This has resulted in the escape of over 2000 prisoners across the Nigeria prisons (Wikipedia 2016).

By late 1980, the Nigerian Prison Service was housing 58,000 inmates in facilities designed for 28,000 inmates (Library of Congress Country Studies; CIA World Factbook 2005). Subsequently, there was a decrease in the prison population by 2010, with 47,628 inmates out of which only 1,300 were convicted while the other 34,328 were awaiting trial (Nwezeh 2010). This showcases the defectiveness of the judicial system handling matters relating to prisons service. Despite efforts by the Federal Government for reforms, in 2014 the population of Nigerian inmates rose to 53,100 (Ohia 2014). Congestion of prisons takes its toll on inmates, the prison system, prison facilities and the society at large, causing premature obsolescence of the few facilities that are grossly inadequate for prison service ("Prison of Horror" 2000).

According to "Prison of Horror" (2000) Nigeria prisons face numerous challenges related to maintenance of facilities. These include: lack of potable water, inadequate and unwholesome sewage facilities, insufficiency of bed spaces, appalling state of sanitation, and inadequate plant and equipment for maintenance operations. Besides these, there is also a paucity of facilities compared to the population of inmates (Ayuk, Emeka and Omono 2013). Additionally, predominant problems that pose a threat on maintenance of prison facilities are administrative bottle neck ("Prison of Horror" 2000), bureaucracy, paramilitary nature of the prisons service, and inadequate government subvention. Such that maintenance of facilities is confined to the

budget rather than budget being derived from maintenance needs for public buildings (Adenuga 2014).

Other challenges could arise from the absence of a prompt trial of inmates awaiting trials ('Prison of Horror', 2000), overcrowding, conditions required for bail, deferred maintenance and high intensity of usage. Olubodun (2001) explains that users' (inmate and prison staff) characteristics (personalities, lifestyle and attributes) exert a significant influence on maintenance needs. The study further claims that users' maintenance needs vary according to building type and its use. This suggests the magnitude of maintenance needs for prison facilities that are in use for 24hours in a day and 7days in a week by persons with alleged criminal attitude.

Despite several reports in print and social media on the deplorable state of Nigerian prison facilities, not much attention has been paid to them by the relevant authority. These challenges have consequences on the Nigerian Prisons Service as they put a lot of strain on budgeted maintenance costs, stretch the workforce, and affect occupants' needs/priorities in terms of health, safety, security, functional performance and satisfaction.

2.1 Factors affecting prison maintenance management

Critical issues that affect maintenance management are enormous and these impacts on the overall maintenance activities of prison facilities just as in other facilities or system. The major factor influencing maintenance management is financial (Zakaria, Arifin, Ahmad and Aiyub 2012), although other factors cannot be overlooked.

Funding: Zakaria et al. (2012) opine that maintenance costs are necessary expense that are part of the operating budget while Murthy, Atrens and Eccleston (2002) see cost of maintenance (preventive, corrective and predictive) as a fraction of total operating budget. It is important that effects of such factors are assessed for optimum maintenance management (Oladapo 2005). Nigerian Prison Service's total annual capital expenditures between 1985 and 1988 ranged from N3 million to N11.6 million (Library of Congress Country Studies; CIA World Factbook 2005). In 2012, the total expenditure was N56.7billion. Capital expenditure was N3billion while construction of fixed assets and repairs of fixed assets was N1.5 billion and N716 million respectively (www.budgetoffice.gov.ng). This shows a rise in capital expenditure and government concern for the maintenance budget.

Deterioration due to age of buildings or facilities: Another influential factor includes the rate at which prison facilities/systems deteriorate; facilities, plant/equipment and tools degenerate with age and use. Deterioration of facilities worsens the condition of facilities and ultimately increases cost of operation of facilities or render facilities non operational (Durango and Madanat 2002). The rate of deterioration of facilities could be attributable to decisions made during design, manufacturing and construction of the facilities, design characteristics, environmental condition, intensity of facilities usage and technical skills of operator and the maintenance officers (Durango and Madanat, 2002; Murthy, et al. 2002).

Plant, equipment, materials and spare parts for maintenance operations: There are factors influencing the choice of plant and equipment for maintenance operations as regard to when and where to purchase based upon data from previous machines and competing suppliers

(Sherwin 2000). In essence, the use of poor quality materials and spare parts affect the quality of maintenance, repairs and efficiency of maintenance.

Pun, et al. (2002) acknowledge that effective maintenance management is attributable to proper deployment of maintenance resources such as spare parts, maintenance materials, tools, equipment and manpower. In the same vein, Arditi and Nawakorawit (1999) affirm that the functional design of facilities and quality of materials and equipment used are of major importance to maintenance activities.

Reckless use of facilities: Zubairu (1999) asserts that maintenance problems are aggravated by the uncaring attitude and concerns of users of public facilities that see the maintenance of public facilities as the sole responsibility of government. The need for repairs and maintenance often thus results from vandalism, misuse and improper handling by users' of facilities (Technical Information Document 2000)

Third-party vandalism: Third-party vandalism is the crime of destroying or damaging of equipment, facilities deliberately. It is a nuisance attitude involving broken glass, graffiti, destruction of materials and damage to equipment (Farinloye, Odusami and Adewunmi 2013). Vandalism is also acknowledged as a significant factor determining the maintenance requirement of any facilities or systems (Olubodun 2001).

Delay in reporting failures and executing repairs: Delay in reporting defect by the users of facilities and executing repairs is likely to cause permanent damage. Duffuaa and Al-sultan (1997) maintain that with a well developed schedule for maintenance jobs, delay in executing maintenance activities are likely to be minimised.

Workmanship: There is frequently a shortage of qualified and trained technical skill and manpower requirement (Duffuaa and Al-sultan 1997) to undertake maintenance activities. This shortage of skill has a great impact on the workmanship outcome of technical skill workers in the maintenance of infrastructure and facilities (Forster and Kayan 2009). Poor workmanship is reducible by quality control and training. Provision of technical training via traditional skills education and professional training has been recognised to relieve the shortage of skills and inadequacy of professional skill for specialised maintenance activities (Forster and Kayan 2009).

Training and development of maintenance personnel: Maintenance works are essentially performed by craftsmen most of whom acquire skill by 'watch and learn' and by apprenticeship training for skill development. Lack of technical skill training leads to poor quality of maintenance particularly where technical skill is required (Sherwin 2000). Training and development of employee involves acquisition of knowledge and specialized skills required to perform their duties properly. Technical skills training increase optimum performance of tasks and productivity of maintenance (Abdullah Sani, et al. 2012). Training assists in maintenance resource allocation when scheduling maintenance tasks, helps in quicker maintenance delivery and ensures safe on-site practice (CITB 2008).

Lack of discernable maintenance culture: Developing countries are well known for their poor maintenance culture (Mushumbusi 1999). Lack of discernable maintenance culture in public buildings leads to environment that are not conducive for occupants, such as hospital, prison, etc. People working and interacting in public facilities are often exposed to allergic like dizziness, nausea, irritation of mucus membrane and sensitivity to odour for waste, poor toilet facilities and unkempt environment (Adenuga and Ibiyemi 2012). A study of Faremi and

Adenuga (2012) confirms lack of a discernable maintenance culture as a factor responsible for poor maintenance management of public facilities. Maintenance culture has been recognised to influence the quality of maintenance work which invariably extends the life cycle of facilities as well as health and safety of occupants (Abdullah Sani, et al. 2012).

Maintenance work priorities: Policy statements are crucial to an organisation. They describe how the organisation deals with maintenance activities, with the standards to be achieved being well stated when carrying out maintenance works. This has to cover the financing and major maintenance programmes to be carried out within a given span of time. The limited resources available necessitate the drawing up of a priority list in terms of what is viewed as emergency work or what is to be phased out for future dates. This is usually prioritised based on the physical characteristics (degree of deterioration), economic value of the facilities and statutory requirements to be observed (Mushumbusi 1999).

Lack of motivation for maintenance staff: Government attitude towards maintenance of its public facilities can often be disturbing. Most times owners of facilities take short-term approach to maintenance, failing to get the benefits of regular minor interventions (Forster and Kayan 2009). To correct this, it is important to have staff motivated for a maintenance regimen. Motivation is the act of encouraging a person in achieving a certain goal. This can make a work environment to be filled with passion and every maintenance staff becomes more dedicated to maintenance tasks they are assigned to do. Motivation can be created for maintenance staff through recognition, a reward system and support from management commitment towards the welfare of individual (Abdullah Sani, et al. 2012).

Construction of facilities: The design and construction of facilities must be strictly monitored and should involve the technical competency of the maintenance profession. Faulty design and construction of facilities is attributable to degradation of facilities (Murthy, et al. 2002).

Overcrowding: Increase in rate of growth of inmates relative to prisons' installed capacities has resulted in congestion of prisons (PRAWA 2000). Congestion of prisons has a negative impact on inmates, the prison system and maintenance of prison facilities. This could also cause premature obsolescence of the few facilities that are grossly inadequate for prison service ('Prison of Horror' 2000). This has also been identified as a significant factor that affects maintenance of prison infrastructure (Farinloye, Adenuga and Iyagba 2010).

Inspection of facilities: Lee (1992) identifies planning of facilities inspection as a critical function in the maintenance of facilities. The inspection of facilities is important as this gives a clear picture of the magnitude of maintenance works to be carried out and relatively maintenance resources to be utilized.

3. RESEARCH METHODOLOGY

The study was conducted in prisons in South-West, Nigeria. This consist of Lagos having five (5) prisons, Ogun having five (5) prisons, Oyo having two (2) prisons, Osun having two (2) prisons, Ondo having five (5) prisons, and Ekiti State having one (1) prison till date (PRAWA, 1999; www.prisons.gov.ng). The study population was made up of all the prison maintenance staff in the 20 prisons located across South-West, Nigeria (www.gov.ng/prison).

Structured questionnaires were administered to prison maintenance staff across the South-West. The entire number of the prison maintenance staff in the unit which was relatively low, this prompted the study to adopt census sampling technique, where every member of the population was sampled (Statistic Canada, 2013). The number of prisons across Nigeria is 155 while the number in South-West, Nigeria is 20; this makes up 12.9% of the total number of Nigerian prisons (Wikipedia, 2016). This implies that the study on all prisons in South-West could be a good representation of the whole prisons across Nigeria. The census sample is an approach suitable for small population, as it eliminates error and provides data on all the individuals in the population. For this study, an accuracy of $\pm 5\%$ was desired; hence the sample size of forty two prison maintenance staff from the twenty (20) prisons study.

4. RESULTS AND DISCUSSION

Factors affecting maintenance management of prison facilities

Table 1 shows the responses of prison maintenance staff on factors affecting maintenance management of prison facilities in prisons across states in South-west, Nigeria. To quantify the effect of factors affecting the maintenance management of prison facilities, a graduated scale of 1- 5 was used and mean score were calculated. The mean values were interpreted using the following scale $1.00 \leq MS < 1.49$ means insignificant, $1.50 \leq MS < 2.49$ means barely insignificant, $2.50 \leq MS < 3.49$ means partially significant, $3.50 \leq MS < 4.49$ means significant and $4.50 \leq MS \leq 5.00$ means highly significant.

Prison maintenance staff in Lagos prisons indicated that effects of overcrowding and insufficient funding (4.33) ranked first was significant. It was also indicated that the effect of poor quality of materials and spare parts used for maintenance repairs (1.50) ranked sixteenth was barely insignificant. In Ogun prisons, prison maintenance staff indicated that effect of overcrowding and insufficient funding (3.75) ranked first were significant while the effect of reckless use of facilities (1.25) ranked sixteenth was insignificant.

Prison maintenance staff in Oyo prisons considered the effects of natural deterioration of facilities due to age (4.00) ranked first and third-party vandalism (3.80) ranked second to be significant. Also, barely insignificant factors were maintenance works not based on priorities and delay in reporting failures (2.00) ranked tenth, insufficient funding and poor quality of materials and spare parts used for maintenance repairs and irregular inspections (1.80) ranked thirteenth and poor workmanship (1.75) ranked sixteenth.

Table 1: Factors affecting Maintenance Management of Prison Facilities in South-West, Nigeria.

Factors	N	Lagos Prisons		Ogun Prisons		Oyo Prisons		Ondo Prisons		Ekiti Prison		Pooled Mean Score	Overall ranking
		MS	R	MS	R	MS	R	MS	R	MS	R		
Natural deterioration due to age of facilities.	20	4.00	3	3.50	3	4.00	1	4.57	1	3.67	4	4.05	1
Overcrowding	21	4.33	1	3.75	1	2.33	8	4.25	2	4.00	2	3.86	2
Inadequate training & development for maintenance staff	22	3.67	6	3.00	6	2.25	9	3.00	5	4.33	1	3.14	3
Insufficient funding	23	4.33	1	3.75	1	1.80	13	3.38	4	1.67	14	3.00	4
Lack of discernible maintenance culture	21	3.50	8	2.75	10	2.50	5	3.50	3	2.33	10	3.00	4
Inadequate plant & equipment for maintenance operations	22	3.67	6	3.00	6	2.75	4	2.63	6	3.67	4	2.91	6
Lack of motivation for maintenance staff	23	4.00	3	2.50	11	2.80	3	2.63	6	3.00	6	2.87	7
Third-party vandalism	23	2.67	13	2.50	11	3.80	2	1.87	9	1.33	15	2.43	8
Irregular inspections	23	2.67	13	3.00	6	1.80	13	1.63	10	4.00	2	2.35	9
Delay in executing repairs	22	4.00	3	2.50	11	2.00	10	1.38	12	3.00	6	2.27	10
Poor construction of facilities	23	2.67	13	3.50	3	2.40	6	1.13	15	2.67	9	2.22	11
Maintenance work not based on priorities	22	3.00	10	2.50	11	2.00	10	2.25	8	1.33	15	2.22	11
Poor workmanship	22	3.00	10	3.00	6	1.75	16	1.50	11	2.33	10	2.14	13
Poor quality of materials & spare parts used for repairs	21	1.50	16	3.33	5	1.80	13	1.38	12	2.33	10	1.90	14
Reckless use of facilities.	23	3.33	9	1.25	16	2.40	6	1.13	15	2.33	10	1.87	15
Delay in reporting failures	23	3.00	10	2.50	11	2.00	10	1.38	12	3.00	6	1.83	16
Grand		3.37		2.86		2.38		2.31		2.69		2.61	

*MS=mean score, R=ranking, N=number of respondents

Coding: HS = highly significant, 5; S = significant, 4; PS = partially significant, 3; BIS = barely insignificant, 2; IS = insignificant, 1. Interpreting scale: $1.00 \leq MS < 1.49$ means insignificant effect, $1.50 \leq MS < 2.49$ barely insignificant effect, $2.50 \leq MS < 3.49$ means partially significant effect, $3.50 \leq MS < 4.49$ means significant effect and $4.50 \leq MS \leq 5.0$ means highly significant effect.

In Ondo prisons the effect of deterioration due to age of facilities (4.57) ranked first was highly significant while the effects of overcrowding (4.25) ranked second and lack of a discernible maintenance culture (3.50) ranked third were significant. Ondo prison maintenance staff also indicated that effects poor construction of facilities and reckless use of facilities (1.13) ranked fifth were insignificant. In the Ekiti prison, maintenance staff indicated that the effects of inadequate training and development for maintenance staff (4.33) ranked first was significant. Also, the effects of maintenance works not based on priorities and third-party vandalism (1.33) ranked fifteenth were insignificant.

Overall, prison maintenance staff indicated that the effects of natural deterioration due to age of facilities (4.05) and overcrowding (3.86) were significant. It was indicated that poor quality of materials and spare parts used in repairs (1.90), reckless use of facilities (1.87), and delay in reporting failures (1.83) were barely insignificant. The study revealed the predominance of diverse factors affecting the maintenance management of prison facilities in each of the prison locations across South-west, Nigeria. This implies that the factors like natural deterioration due to age of facilities, overcrowding, and inadequate training and development of maintenance staff among other factors strongly affect maintenance management of prison facilities.

Hypothesis

Null hypothesis: There is no agreement in ranking of factors affecting maintenance management of prison facilities in south-west.

Alternative hypothesis: There is an agreement in ranking of factors affecting maintenance management of prison facilities in south-west.

Table 2: Kendall's coefficient of concordance test of agreement on ranking of factors affecting maintenance management of prison facilities

No of cases	Kendall's W	Chi-square	Df	P-value
16	0.271	78.126	18	0.001

Kendall's coefficient of concordance test was further used to test for agreement among the respondents in their ranking of the sixteen factors. Test indicates a significant agreement among the respondents at $p < 0.05$.

This result is consistent with Oladapo (2005), where age of buildings and overcrowding are identified as important determinant factors in housing maintenance. The study is also in line to Farinloye et al. (2010) study on the significance of factors affecting maintenance of which deterioration of facilities due to age and staff training was rated significant. These findings suggest that the Nigerian Prisons Service should consider these underlying critical factors when making relevant decisions on maintenance works.

Predominant factors that affecting maintenance management of prison facilities in South-West, Nigeria were established. The critical underlying factors are deterioration due to age of facilities, overcrowding as well as inadequate training and development for prison maintenance staff. Also, study established factors affecting maintenance management of prison facilities in each of the prison locations.

5. CONCLUSION AND RECOMMENDATIONS

The study acknowledged the prevalence of barriers to implementation of satisfactory maintenance management. Some of the predominant factors that affect maintenance management of prison facilities include age of building, overcrowding and inadequate staff training and development. This gives an insight to issues militating against maintenance of prison facilities; these issues require immediate attention of the relevant stakeholders.

Prison maintenance staff should have access to prompt maintenance training and development to enhance their performance in maintenance services delivery. Continuous training provides them with the appropriate skills, attitude and degree of sensitivity required for dealing with the maintenance management of prison facilities. Government interest in the Prisons Service should encompass both the social welfare of prisons and the technical efforts aimed at redressing the deplorable state of prison facilities. The government should provide all the necessary maintenance and capital resources. Such as sufficient maintenance budgets, plant and equipment for maintenance operations and enabling policies that would ensure functionality of prison facilities. Congestion of prison facilities should be reduced or, if possible eliminated by ensuring that the judicial arm of government addresses all awaiting trial cases on time. All existing prison facilities should be promptly and adequately maintained. New prison buildings should be constructed and provided with adequate facilities provided to ease congestion.

6. REFERENCES

- Abdullah Sani, S. I., Mohammed, A. H., Misnan, M. S. & Awang, M. (2012) 'Determinant factors in development of maintenance culture in managing public asset and facilities', *Procedia- Social and Behavioral Sciences*, Vol. 65, pp. 827-832.
- Adenuga, O. A. (2008) 'Evaluation of maintenance management practice in public hospital buildings in South-West, Nigeria', University of Lagos, Nigeria
- Adenuga, O. & Ibiyemi, A. (2012) 'An assessment of the state of maintenance of public hospital buildings in Southwest Nigeria', *The Australasian Journal on Construction Economics and Building*, Vol. 19 (2), pp. 51-60
- Adenuga, A. O. (2014) 'Maintenance management financing in public hospital buildings: A case study of South Western, Nigeria', *Construction Research Journal*, Vol. 3(1), pp. 129- 149.
- Agomoh, U. & Oghozor, E. (2006). 'Post colonial reform of Nigeria prison. Issues and challenges', Paper presented at the 11th International conference on penal abolition (ICOPAXI), , Tasmania, Australia.
- Arditi, D. & Nawakorawit, M. (1999) 'Issues in Building maintenance: Property Managers perspective', *Journal of Architectural Engineering*, Vol. 5 (4), pp. 117-132.
- Anonymous, (2000) ' Prison of horror'.
- Ayuk, A. A., Emeka, J. O. & Omono, C. (2013) 'The impact of reforms on the welfare of the inmates: A case study of Afokang prison, Calaber, Cross river state, Nigeria', *Global Journals of Human Social Science*, Vol. 3 (2), pp. 1-6.
- CITB. (2008) ' *Training. It's good for Business*', Available from: <http://www.construtionskills.net/> [29 May2008]
- Duffua, S. O. & Al- Sultan, K. S. (1997) 'Mathematical programme approaches for the management of maintenance planning and scheduling', *Journal of Quality in Maintenance Engineering*, Vol. 3 (3), pp.163-196
- Durango, P. L. & Madanat, S. M. (2002) 'Optimal maintenance and repair policies in infrastructure management under uncertain facility deterioration rates: an adaptive control approach', *Transportation Research Part A*, Vol. 36, pp. 763-778.
- Faremi, J. O. & Adenuga, O. A. (2012) 'Evaluation of maintenance management practice in banking industry in Lagos state, Nigeria', *International Journal of Sustainable Construction Engineering and Technology*, Vol 3 (1), pp. 45-53.

- Farinloye, O. O., Adenuga, A. O. & Iyagba, R. A. O. (2010) 'Assessment of maintenance management practices in Lagos and Ogun state prisons of Nigeria', *International Journal of Contemporary Urban and Regional Development from Multidisciplinary Perspectives*, Vol. 2 (1&2), pp. 82-90.
- Farinloye, O., Odusami, K. & Adewumi, Y. (2013) 'Theft and vandalism control measures on Building site in Lagos, Nigeria', *Journal of Engineering, Project and Production Management*, Vol. 3 (1), pp. 9-21.
- Foster, A. M. & Kayan, B. (2009) 'Maintenance for historic buildings: A current perspective', *Structural Survey*, Vol. 27 (3), pp. 210-229.
- Her Majesty Prison Service, (2005) 'PSO 5901 Maintenance of prison service building. Prison Service Order', Available from: www.justice.gov.uk [15 July 2014]
- HSE. (2000) 'How to Deal with Sick Building Syndrome (SBS): Guidance for Employers, Building Owners and Building Manager', Available from: www.hse.gov.uk [28 August 2016]
- Lee, R. (1992) *Building maintenance*, London: BSP Professional books
- Library of congress country studies; CIA World Factbook. (2005) 'Nigeria crime and punishment', Available from: <http://www.photius.com>. [17 September 2013]
- Murthy, D. N. P., Atrens, A., & Eccleston, J. A. (2002) 'Strategic maintenance management', *Journal of Quality in Maintenance Engineering*, Vol. 8 (4), pp. 287-305.
- Mushumbusi, M. Z (1999), 'Maintenance management for built environment in developing countries' Paper presented at CIB W55 & W65 Joint Triennial Symposium. Customer satisfaction: A focus for research and practice, September 10 1999, Cape Town, South Africa. Available from: <http://www.irbnet.de/daten/conda/CIB3356.pdf>.
- Nwezeh, K. (2010, October 2) 'Nigerian prison's rising population', *This Day Live*. Available: www.thisdaylive.com. [March 16 2015]
- Ohia, I. (2014, March 7) 'Nigerian prisons: Hell on Earth!', Available: www.mynewswatchtimes.com. [March 16 2015]
- Oladapo, A. A. (2005) 'An evaluation of the maintenance management of the staff estates in selected first generation Universities in Southwestern Nigeria', Obafemi Awolowo University, Nigeria.
- Olubodun, F. (2001) 'A multivariate approach to the prediction of maintenance needs in public housing: The tenant dimension', *Structural survey*, Vol. 19 (2), pp. 133-141.
- PRAWA, (2000) 'Prison and penal reform factsheet', Penal reform media network *PERMNET*, Vol 2 (4), 1-9.
- Pun, k. F., Chin, K. S., Chow, M. F., & Lau, H. C. W. (2002) 'An effectiveness- center approach to maintenance management: A case study', *Journal of Quality Maintenance in Engineering*, Vol. 8 (4), pp 346-368.
- Shewin, D. (2000) 'A review of overall models for maintenance management', *Journal of Quality in Maintenance Engineering*, Vol 6 (3), pp. 138-164
- Sodangi, M., Khamdi, M. F., Idrus, A., Hammad, D. B., & Umar, A. A. (2014) 'Best practice criteria for sustainable maintenance management of heritage buildings in Malaysia', *Procedia Engineering*, Vol. 77, pp. 11-19.
- Sui, G. K. W., Bridge, A., & Skitmore, R. M. (2001) 'Assessing the service quality of building maintenance provider: mechanical and engineering services', *Construction Mainagement and Economics*, Vol. 19 (7), pp. 719-726
- Technical Information Document, (2000) 'Maintenance management systems', TID AM – 01.
- Wikipedia. (2016) 'Nigeria prison break.', Available: https://en.m.wikipedia.org/wiki/Nigeria_prison_service. [August 28 2016]
- Yahaya, A. (2012) 'An analysis of socio-economic impact of imprisonment in Nigeria', *International Institute for Science, Technology and Education*, Vol. 2 (9), pp. 148-155
- Zakaria, H., Arifin, K., Ahmad., S. & Aiyub, K. (2012) 'Financial factor affecting maintenance management in safety and health practices', *International Journal of Modern Engineering Research*, Vol. 2 (5), pp. 3061-3067.
- Zubairu, S. N. (1999) 'Maintenance of government office building in Nigeria – a post occupancy evaluation approach', University of Lagos, Nigeria.

FACILITIES MANAGEMENT AND TRENDS IN BUSINESS SERVICES RESEARCH

J. Bröchner

*Department of Technology Management and Economics,
Chalmers University of Technology, SE-412 96 Göteborg, Sweden*

Email: jan.brochner@chalmers.se

Abstract: Mainstream research into business services is changing; there are shifts in emphasis and new approaches. Facilities management (FM) is a business service with particular features due to its linking of durable and fixed assets (buildings) to human activities in the workplace. The purpose here is to analyse reviews of current services research, identifying new opportunities for FM researchers. FM citation patterns for nine mainstream services journals show that marketing research dominates. Service attributes for FM are shared partly by professional services and industrial maintenance. Using eight service research reviews, published 2013-2017, trends and research needs are identified for sourcing, supply chain management, innovation, service ecosystems, public services, big data and servitization. An FM perspective is applied in the analysis. Operational themes identified in the analysis include FM employee satisfaction, delivery risks, social sustainability and use of big data. Suggested external themes for FM providers refer to joint analysis of client and provider capabilities, the role of FM consultants, interactions of relational and contractual governance, sales and delivery of innovations, multi-actor innovation including public and private collaboration, service demand management and supply chain management coordinating demand and supply. Global comparisons are desirable.

Keywords: Business Services, Facilities Management, Research Trends, Reviews

1. INTRODUCTION

Mainstream research into business services is slowly changing and there are shifts in emphasis as well as new approaches. That facilities management (FM) is a business service, provided internally in organizations or supplied externally over the market, has long been recognized (Bröchner, 2001; Salonen, 2004; Lehtonen, 2006; Coenen and von Felten, 2014).

Considered as a business service, FM has particular features due to its linking of durable and fixed assets (buildings) to human activities in the workplace. The ISO 41011:2017 “Facility management – Vocabulary” standard definition of FM is clear in this respect “organizational function which integrates people, place and process within the built environment with the purpose of improving the quality of life of people and the productivity of the core business”.

There is currently a rapidly growing number of research publications dealing with all manner of business services. Not all of this research can be assumed to be equally applicable to an FM context. Much of the service literature downplays the unique features of various types of service production. While most authors respect a fundamental distinction between consumer services and business services, there is often less awareness of sources of variety in business services. There is also the larger issue, frequently raised in services innovation studies, of how different the processes associated with new services and new goods really are.

If there is a suspicion that FM research fails to exploit recent findings and conceptual structures developed for other business services, we need to characterize their otherness. Which common

features make it predictable that a particular type of business services will be relevant and applicable to FM? Unfortunately, the effect of context (Voss et al., 2016) is often downplayed by service researchers who make sweeping statements of general applicability of their findings to a broad range of services.

Against this background, the purpose here is to analyse reviews of current services research, identifying new opportunities for FM researchers.

This paper begins by considering how FM research depends on mainstream services journal articles, followed by a discussion of how FM fits into classifications of business services. Using available reviews of current research into business services, potential fields for expanding the present scope of FM investigations are identified and discussed.

2. FM RELIANCE ON MAINSTREAM SERVICES RESEARCH

To what extent do FM researchers rely on mainstream services research? A simple answer to this question can be based on identifying scientific journals with a clear FM orientation and then investigating how their authors cite articles published in journals associated with more general research into services. Citation patterns in two leading FM journals (Facilities, Journal of Facilities Management) can be seen in Table 1 for the eleven-year 2006-2016 period. Mainstream service journals either include “service(s)” in their names (Journal of Service Management, Journal of Services Marketing, Journal of Service Research, Managing Service Quality, The Service Industries Journal) or exhibit a broader scope (European Journal of Marketing, Journal of Business Research, Journal of the Academy of Marketing Sciences, Journal of Marketing).

Table 1: No. of 2006-2016 articles in Facilities and Journal of Facilities Management citing mainstream services journals

Journal	Citing articles
Journal of Marketing	38
European Journal of Marketing	27
Journal of Service Management (earlier: International Journal of Service Industry Management)	20
Journal of the Academy of Marketing Science	20
Managing Service Quality	20
Journal of Business Research	18
Journal of Services Marketing	16
Service Industries Journal	13
Journal of Service Research	7

The first three journals in Table 1 contain some of the most frequently cited articles in all services research, but these articles are mainly directed towards consumer services. It is also obvious that FM researchers have depended more on marketing research than on studies based

on operations management or economic theory. It should be noted that the total number of FM journal authors citing mainstream journals during the period chosen is much smaller than the sum of “citing articles” in Table 1 (=94), as there is a tendency for authors who cite a particular services article also to cite other articles from the mainstream journals. On the other hand, references to monograph treatments of services themes are omitted, which at least earlier were admittedly influential. It is clear that many FM authors are familiar with mainstream literature, confirming that much of it is felt to be relevant. Nevertheless, there remains a potential for learning more from the rapidly growing number of studies that concern business services rather than consumer services.

3. CLASSIFYING BUSINESS SERVICES

In order to examine the business services research field looking for approaches that are relevant to FM, it is obviously necessary to recognize similarities and differences in service contexts. There have been many attempts to classify business services, also known as producer services, or business-to-business (B2B) services. Wynstra et al. (2006) developed a classification of business services, based on “how the buying company uses or applies the service with respect to its own business processes”. This meant classifying services according to usage situations rather than provider types. Their classification was influenced by a purchasing perspective and probably by a concern with the relation between and manufacturing; they devised four categories of business services: component services, semi-manufactured services, instrumental services and consumption services. It seems that FM does not fall neatly into only one of these categories. Later, van der Valk and Axelsson (2015) analysed 88 journal articles on services classifications, proposing four categories or segmentation attributes, roughly according to (1) how the service is used, (2), the extent of customer contact, (3) extent of customer participation in service production/consumption, and (4) extent to which the service is customized. While this offers a more useful framework also for FM services, it does not highlight the role of tangible assets in service delivery.

The immediate relation to the built environment, implying heavy reliance on immobile assets owned by, or at least provided by, the client should give FM a characteristic profile as a business service. No other type of business services has given rise to a comparable volume of research into service effects on user productivity, as measured by their perceptions of the influence of workplace environmental factors (de Been et al., 2016), but unlike other types of business services, there has been little research into provider productivity (Bröchner, 2017).

Considerable research effort has gone into the study of knowledge-intensive business services (KIBS). There is no consensus definition of KIBS; Muller and Doloreux (2009) have given an overview of various attempts to define KIBS. FM is seldom or never considered as belonging here. Discussing KIBS and innovation, Doloreux et al. (2010, p. 6) recognize business services where “activity may be standardised and involve few changes in client organisations”, and their examples include waste disposal, accounting services and facilities management.

Professional service firms are typical providers of KIBS. In his study of what characterizes professional service firms, von Nordenflycht (2010) lists three “important characteristics” of PSFs: knowledge intensity, low capital intensity and a professionalized workforce. It can be claimed that knowledge embodied in equipment and in routines should be taken into account, but it is more common to find that “professional services” are interpreted as that the firm has an “intellectually skilled workforce” so that human capital intensity is thought to be crucial for

the classification. Industrial maintenance is on the other hand an example of business services not counted as a professional service; increasingly dependent on advanced information and communication technologies, it does require corresponding skills in the workforce. Many facilities services appear to follow the same path today.

Four out of the eight service attributes in Table 2 are taken from the classification synthesis proposed by van der Valk and Axelsson (2015), followed by another four intended to capture FM relevant characteristics. How customers use the service is characterized as consumption or as being instrumental (=potentially changing the way buyers of these services work) according to these two authors. Here, FM can be seen as sharing at least a few attribute values with both professional services and industrial maintenance services. Studies of industrial maintenance services are increasingly presented by researchers as cases of servitization, which will be discussed later (see 6.5) more in detail.

Table 2: Types and attributes of business services

Service attribute	FM	Professional services	Industrial maintenance
use	consumption	instrumental	consumption
customer contact	high	high	low
customer participation	mixed	high	low
customization	mixed	high	mixed
location	client	mixed	mixed
resource mobility	low	high	mixed
staff education	mixed	high	mixed
tangibility of results	mixed	none	high

4. METHODOLOGY: USING REVIEWS OF SERVICES RESEARCH

It is only recently that comprehensive overviews of business service studies have become available. A core set of eight review articles, published in leading service journals not before 2013, and representing current themes in (primarily) business service research, has been identified (Table 3). If there exists more than one such review article for a particular theme, selection has been based on number of references in the article. Most of these review articles have already been frequently cited in the researcher community.

Some reviewing authors have used text search methods without checking the quality and importance of articles covered by their surveys, while others have relied on more traditional methods for assessing which articles are worth including.

In addition to the eight article reviews, the exercise reported by Ostrom et al. (2015), which includes a survey of how 334 researchers view priorities for service research, has been used, although it is not exclusively concerned with business services.

Table 3: Selected review articles

Service theme	Author(s)	No. of articles included	Time span
sourcing	Lacity et al.	174	2010-2014
supply chain management	Wang et al.	116	1991-2015
innovation	Carlborg et al.	128	1986-2010
innovation	Witell et al.	300	1979-2014
service ecosystems	Koskela-Huotari et al.	51	1934-2016
public services innovation	Djellal et al.	139	1958-2013
big data	Maglio and Lim	59	1988-2015
servitization	Baines et al.	232	1988-2015

These reviews have been analysed with (a) special emphasis on issues that can be related to FM and (b) on what the authors consider as trends and emergent issues in current research in each subfield. The following analysis is split between the two research fields of service sourcing and service innovation.

5. SERVICE SOURCING

5.1 Service sourcing in general

In their review of contributions to the study of sourcing of business process and information technology services, Lacity et al. (2016) while comparing with their own earlier review found a “deeper exploration of the direct effects of transaction attributes, sourcing motivations, client and provider capabilities, and governance on sourcing decisions and outcomes”. They also identified a “more nuanced understanding of relational governance and its interaction with contractual governance”. Furthermore, they point to a lack of studies of advisors to clients, while almost all earlier research has had its focus on clients and providers, ignoring the function of intermediaries in the market. Lacity et al. (2016) also see more studies of pricing models as desirable.

5.2 Supply chain management

Supply chains for business services are an obvious extension of service sourcing. Wang et al. (2015) have performed a review of operational models for service supply chain management. They went through recent articles in the operations research and management science literature, focusing also on innovative measures associated with service supply chains. Here, they divide supply chain systems into Service Only Supply Chains (SOSC) and Product Service Supply Chains (PSSC). It is not immediately apparent whether FM falls neatly into only one of these categories of systems. To some extent, FM does manage physical products as part of the services provided, and it is mostly to be seen as a PSSC, like aircraft maintenance, e.g. Wang

and coauthors discuss service demand management in particular. Some of the PSSC issues that they note are performance-based contracts, product bundles with warranty/after-sales service, disruption risk and service, outsourcing, service competition, customer service, logistics service, service commitment strategy and financial service.

Wang et al. (2015) find that there are fewer studies of service demand management and service supply chain coordination (combining demand and supply management). More studies on operational risk, e.g. of proper hedging mechanisms, are seen as needed. According to them, social welfare and non-profit service organizations and environmental sustainability studies should be developed. More generally, FM coordination is often a question of managing supply chains formed by service subcontractors and their subcontractors; in addition, there can be complicated chains for sourcing e.g. office supplies.

6. SERVICE INNOVATION

6.1 Innovation and services in general

Repeating a 2010 exercise, Ostrom et al. (2015) engaged no less than 334 service researchers in prioritizing research topics, first through round table discussions, then in an online survey of priorities. A basic framework with four types of research priorities was used: strategic, design/delivery, value creation and outcome priorities. While the exercise has not been restricted to business services, many of the results are particularly or at least partly relevant to research outside the field of consumer services. The authors found shifts in priorities between 2010 and 2015, such as a new “focus on how big data can be used to design and enhance service”. There was also more emphasis in 2015 on global aspects of services. Among the state-of-the-field perceptions voiced by participants, there was a strong emphasis on “service research should incorporate more ‘real’ business data (e.g. employee performance, customer equity, firm profitability) than at present”.

“Stimulating service innovation” is one of three strategic research priorities in the framework offered by Ostrom et al. (2015). Here they illustrate the “rapidly changing technological context in which innovation now often takes place” by a single example which is intended to illustrate the “connection between cutting-edge technology, networks and innovation”. This example is actually related to FM since it is about the redesign of a U.K. organization’s headquarters. Researchers had used body sensors to track interaction between individuals. Turning to the source publication (Brown et al., 2014), however, while it is true that the new layout was intended to foster encounters leading to innovative ideas, the architects had only used the sensor data to verify that there was a difference in patterns before and after the office change. In reality, these data were not used as a design tool for predicting the outcome of the new layout. Moreover, as usual, we have little hard evidence of whether the increase in encounters is linked to a higher degree of innovation in the primary activities of the firm that uses the office.

6.2 Service innovation

Carlborg et al. (2014) have analysed 128 articles on service innovation from the 1986-2010 period. They identified a formation phase (1986-2000), when the service offering itself was in focus, followed by a maturity phase where customer involvement and organizing were typical research topics. In a third phase, the multidimensional phase, researchers tend to emphasize

linkages between service innovation and business strategy. A shift of interest over the years to manufacturing firms that add services to their products, has also led to attempts to apply a synthesis approach, where theories of new product development meet those of new service development. There is then a risk that the concept of service is broadened so that loses its edge. At the same time, it is important to recognize the difference between innovation in service firms, such as external FM providers, from service innovation, which might occur internally in any organization.

Two other observations made by Carlborg et al. (2014) merit attention: an emerging issue in the third (multidimensional) phase is that of deployment of service innovation, such as sales and delivery. Furthermore, they point to the potential for modularization in service innovation.

Witell et al. (2016) studied how service innovation has been defined, using network analysis and text mining. They distinguish between assimilation (service innovation is like manufacturing innovation), demarcation (services are different) and synthesis (more of a compromise) perspectives on service innovation; they find that the commercialization of service innovations is often lost by researchers applying a demarcation or synthesis perspective, where they rather emphasize the development process. The text analysis revealed that key elements of demarcation definitions of service innovation were change, customer, offer and firm. As to time trends, they see a growing number of articles applying the synthesis perspective, while the number of articles adopting assimilation or demarcation perspectives “has neither decreased nor disappeared”; it is possible that the assimilation perspective “regained its strength”.

A recent conceptualization is that of innovation in service ecosystems (Koskela-Huotari et al., 2016). They accept the ecosystem description proffered by Vargo and Lusch (2016): “a complex, self-adjusting system of resource-integrating actors connected by shared institutional arrangements and mutual value creation”. Here, the relational and collaborative aspects of innovation are highlighted, in particular the institutional arrangements and how these can be changed by ecosystem actors. From an FM viewpoint, the role of consultant intermediaries and how clients and providers use or depart from standard contracts can be seen as typical examples.

6.3 Public services innovation

When reviewing contributions to the understanding of innovation in public services, Djellal et al. (2013) start out from the distinctions between assimilation, demarcation and integration/synthesis, further adding the inversion perspective. Inversion refers to the view that at least some services are sources of innovation across the whole economy. They warn against seeing public services innovation as something of its own, and their main recommendation is to consider more integrative views of innovation. Research on multi-actor collaboration, additionally including private sector participants and often stressing the network character of collaborating, is seen as a recent development.

With a generous interpretation, the inversion perspective can be evoked for effects on core business innovation as a consequence of workspace design services.

6.4 Big data

Maglio and Lim (2016) have applied the concept of smart service systems as reliant on Big Data, referring to “large and complex sets of data representing traces of human activities”. The idea of uncovering patterns in data is hardly new for organizations that have a tradition of collecting energy data automatically in buildings (cf. the review by Zhou et al., 2016). The emphasis on human traces has been less visible in FM research, the main exception being data-driven workplace design (Sailer et al., 2015).

Of the four types of sourcing and using big data brought up by Maglio and Lim (2016), FM lies close to “smart operations management”, where big data are directly used to manage objects (examples given include intelligent trash pickup and intelligent traffic control). But there may also be an FM element in smart customization and prevention, where data are mainly sourced from people, creating human-centred smart service systems. This is not to underestimate how the future of collecting, transforming and analysing people-related data can be affected by integrity considerations.

6.5 Servitization

Servitization can be thought of as a “process of building revenue for manufacturers from services” (Baines et al., 2017). What capabilities are required for advanced services within a manufacturer and its downstream network? Baines et al. (2017) identify the phenomenon of reverse servitization, which means that a service firm builds technology innovation competencies and delivers advanced services, thus turning into a servitized manufacturer “from a different route”. Big data is part of the picture, as smart tangible products are more easily tapped for flows of data.

The question of *whose* capabilities in the context of servitization has been pursued further by Story et al. (2017), who have asked what capabilities are required for advanced services within a manufacturer and its downstream network. They conducted both a literatures survey and a series of interviews. What is particularly valuable in their multi-actor view of servitization is that they stress the function of intermediaries as distinct actors with their own agendas, offering clients complementary capabilities. They see it as likely that sustainable competitive advantage is achieved through “complex combinations of interconnected capabilities found within manufacturers, intermediaries and customers”.

Historically, considering FM servitization, the point of origin for downstream integration into FM services has been either manufacturing or construction (Bröchner, 2008). The resulting pattern can be less than permanent, as when CBRE Group acquired Global Workplace Solutions from Johnson Controls in 2015 and when the Skanska Group spun off Coor Service Management in 2004. The development of information and communication technologies, in particular the Internet-of-Things based on sensors in buildings, appears to create new business opportunities for major construction contractors (Robinson et al., 2016). Earlier, the wave of private finance projects (Winch and Schmidt, 2016) led to a quasi-integration of construction and facilities management in concession consortia.

7. DISCUSSION

Going over the various fields of business service research, a number of crosscutting themes that hold a potential for FM relevance can be extracted. These themes are either internal to an organization or concern relations to what is external. Focus is on new themes that are thought to have received little or no attention hitherto in FM research.

First, there are themes concerning operational issues inside the organization that coordinates and produces FM services. It is striking how few studies have been devoted to FM employee satisfaction and its links to performance and building user satisfaction. Issues of operational risk in the delivery of FM services, as well as the corresponding hedging mechanisms, need more attention. Which are the proper risk treatment strategies under the headings of prevention, monitoring and mitigation if risks happen to materialize? Progress has been made in recent years if sustainability issues are considered, but FM studies in this field have usually been concentrated on environmental sustainability. Social sustainability is a broad field of research, including social welfare and non-profit service organizations. While the use of big data is already established for the analysis of energy data from buildings, there should be a potential for more studies that rely on using big data from people and their patterns of behaviour to support smart operations management.

Turning to themes that evoke the external relations of FM providers, there is clearly a fruitful opportunity for analysing jointly the capabilities of both clients and providers, emphasizing the co-production nature of services. How FM clients are supported by advice from FM consultants is also well worth investigating. Although the wider issue of how relational and contractual governance interact in FM contexts has not been left unexplored by FM researchers, it seems that there remain issues that should be approached, inspired by studies of relationships for other business services. One such issue is how pricing models are—and should be—designed for FM services.

Furthermore, while there has been a number of earlier studies of FM innovation, the sales and delivery stages can hardly be said to have been prominent. Multi-actor innovation is a promising theme for research and in particular aimed at situations where private and public actors collaborate. Not without relation to risk analysis, there are questions concerning FM service demand management, with an extension into studies of FM service supply chain coordination, taking into account both demand and supply.

Global aspects of FM is a general theme to pursue. An increasing number of single-country studies could now be followed by more efforts to compare across national boundaries and systematically assess the importance of various levels of economic development and education in a range of countries.

8. CONCLUSIONS

The analysis presented here has been intended to identify new opportunities for FM researchers, based on current developments in business services research. The eight review articles used here are evidence of a lively activity in recent years. An initial and obvious question is to what extent the approaches and findings are relevant to the FM research field. Is it meaningful to learn from studies of more footloose business services, given the fundamental link between FM and the built environment? The overview of how FM authors have cited

mainstream services research showed that this is already an important source of ideas and methods. The further analysis of review articles for trends and research needs allowed identifying a number of themes which should be of FM relevance but which have received little or no attention by the community of FM researchers.

If it can be claimed that there is much that can be taken from mainstream research into business services and then applied to an FM context, it is also possible to argue for a reverse flow of knowledge. More FM-based research could be published in mainstream services journals, making a virtue out of the special dependence on fixed and immobile assets in the provision of FM services. One example where FM researchers have a relative advantage is that they are able to analyse productivity effects on core businesses and not just the internal efficiency of service providers (the analysis of which, on the other hand, is not highly developed in FM studies).

9. REFERENCES

- Baines, T., Bigdeli, A. Z., Bustinza, O. F., Shi, V. G., Baldwin, J. and Ridgway, K., 2017, Servitization: revisiting the state-of-the-art and research priorities. *International Journal of Operations and Production Management*, 37(2), 256-278.
- Bröchner, J., 2001, Facilities management as a special case of business service management. In (ed. K. I. Leväinen) *Facility Management and Service Concepts, International Research Seminar in Real Estate Management, Espoo, 29-30 March 2001*. Helsinki University of Technology, Espoo, pp. 12-18.
- Bröchner, J., 2008, Construction contractors integrating into facilities management. *Facilities*, 26(1/2), 6-15.
- Bröchner, J., 2017, Measuring the productivity of facilities management. *Journal of Facilities Management*, 15(3), 285-301.
- Brown, C., Efstratiou, C., Leontiadis, I., Quercia, D., Mascolo, C., Scott, J. and Key, P., 2014, The architecture of innovation: tracking face-to-face interactions with UbiComp technologies. In: *Proc. ACM UbiComp'14, Seattle, September 13-17, 2014*, pp. 811-822.
- Carlborg, P., Kindström, D. and Kowalkowski, C., 2014, The evolution of service innovation research: a critical review and synthesis. *The Service Industries Journal*, 34(5), 373-398.
- Coenen, C. and von Felten, D., 2014, A service-oriented perspective of facility management. *Facilities*, 32(9/10), 554-564.
- de Been, I., van der Voordt, T. and Haynes, B., 2016, Productivity. In: (eds P.A. Jensen and T. van der Voordt) *Facilities Management and Corporate Real Estate Management as Value Drivers: How to Manage and Measure Added Value*, Routledge, Abingdon, pp. 140-155.
- Djellal, F., Gallouj, F. and Miles, I., 2013, Two decades of research on innovation in services: Which place for public services? *Structural Change and Economic Dynamics*, 27, 98-117.
- Doloreux, D., Freel, M. and Shearmur, R., 2010, Introduction. In: (eds D. Doloreux, M. Freel, M. and R. Shearmur) *Knowledge-Intensive Business Services: Geography and Innovation*, Ashgate, Aldershot, pp. 1-18.
- Koskela-Huotari, K., Edvardsson, B., Jonas, J. M., Sörhammar, D. and Witell, L., 2016, Innovation in service ecosystems—Breaking, making, and maintaining institutionalized rules of resource integration. *Journal of Business Research*, 69(8), 2964-2971.
- Lacity, M. C., Khan, S. A. and Yan, A., 2016, Review of the empirical business services sourcing literature: an update and future directions. *Journal of Information Technology*, 31(3), 269-328.
- Lehtonen, T., 2006, Collaborative relationships in facility services. *Leadership and Organization Development Journal*, 27(6), 429-444.
- Maglio, P. P. and Lim, C. H., 2016, Innovation and Big Data in Smart Service Systems. *Journal of Innovation Management*, 4(1), 11-21.
- Muller, E. and Doloreux, D., 2009, What we should know about knowledge-intensive business services. *Technology in Society*, 31(1), 64-72.
- Ostrom, A. L., Parasuraman, A., Bowen, D. E., Patricio, L. and Voss, C. A., 2015, Service research priorities in a rapidly changing context. *Journal of Service Research*, 18(2), 127-159.
- Robinson, W., Chan, P. and Lau, T., 2016, Finding new ways of creating value: A case study of servitization in construction: One company's journey toward servitization illustrates how systems integrators can capture value through long-term customer relationships. *Research-Technology Management*, 59(3), 37-49.

- Sailer, K., Pomeroy, R. and Haslem, R., 2015, Data-driven design—Using data on human behaviour and spatial configuration to inform better workplace design. *Corporate Real Estate Journal*, 4(3), 249-262.
- Salonen, A., 2004, Characteristics of facility service industry and effects on buyer-supplier relationships. *Nordic Journal of Surveying and Real Estate Research*, 2, 47-66.
- Story, V. M., Raddats, C., Burton, J., Zolkiewski, J. and Baines, T., 2017, Capabilities for advanced services: A multi-actor perspective. *Industrial Marketing Management*, 60, 54-68.
- van der Valk, W. and Axelsson, B., 2015, Towards a managerially useful approach to classifying services. *Journal of Purchasing and Supply Management*, 21(2), 113-124.
- Vargo, S. L. and Lusch, R. F., 2016, Institutions and axioms: an extension and update of service-dominant logic. *Journal of the Academy of Marketing Science*, 44(1), 5-23.
- von Nordenflycht, A., 2010, What is a professional service firm? Towards a theory and taxonomy of knowledge-intensive firms. *Academy of Management Review*, 35(1), 155-174.
- Voss, C., Perks, H., Sousa, R., Witell, L. and Wunderlich, N. V., 2016, Reflections on context in service research. *Journal of Service Management*, 27(1), 30-36.
- Wang, Y., Wallace, S. W., Shen, B. and Choi, T. M., 2015, Service supply chain management: A review of operational models. *European Journal of Operational Research*, 247(3), 685-698.
- Winch, G. M. and Schmidt, S., 2016, Public-Private Partnerships: A review of the UK Private Finance Initiative. In: (eds M. C. Jefferies and S. Rowlinson) *New Forms of Procurement: PPP and Relational Contracting in the 21st Century*, Routledge, Abingdon, pp. 35-51.
- Witell, L., Snyder, H., Gustafsson, A., Fombelle, P. and Kristensson, P., 2016, Defining service innovation: A review and synthesis. *Journal of Business Research*, 69(8), 2863-2872.
- Wynstra, F., Axelsson, B. and van der Valk, W., 2006, An application-based classification to understand buyer-supplier interaction in business services. *International Journal of Service Industry Management*, 17(5), 474-496.
- Zhou, K., Fu, C. and Yang, S., 2016, Big data driven smart energy management: From big data to big insights. *Renewable and Sustainable Energy Reviews*, 56, 215-225.

BRIDGING THE GAP BETWEEN SUSTAINABLE FM AND SUSTAINABLE BUILDINGS

An exploratory study of six public buildings in Norway

D. Collins, T. Haugen and C. Aamodt

Centre for Real Estate and Facilities Management, Norwegian University of Science and Technology (NTNU)

Email: david.collins@ntnu.no

Abstract: The purpose of this paper is to explore how sustainable facilities management (SFM) and sustainable buildings (SB) can be designed and managed, bridging these gaps with a more integrated process. The need to bridge the traditional gap between design, construction and FM demands more effective solutions based on life cycle assessments. This also requires a coordinated approach with emerging environmental and sustainable initiatives in new and refurbished buildings. The solutions to these issues and aspects of the ‘Green Shift’ need to be co-ordinated at the strategic and tactical levels of an organisation with an aim of further implementation at the operational level. This paper takes the form of an exploratory approach based on six different case studies. The data has been sourced from cases studies involving interviews and documentation from large public institutions on how they manage and operate their existing buildings and how FM strategies are coordinated at all levels. A particular focus has been placed on buildings for higher education and research institutions. We have used a theoretical multidimensional framework for analysing the gaps based on models for sustainable development, life cycle assessments of buildings and recognised models for efficient FM. The case studies have been supported by literature research as well as documentation from a number of applied projects. In conclusion, this study demonstrates that in the context of the Norwegian cases, there is currently little consistency in the degree to which the bridging of the gap between Sustainable FM and Sustainable Buildings is achieved or attempted.

Keywords: Assessment, Life Cycle Assessment, Sustainable Buildings, The Green Shift Sustainable FM, Zero Emission Buildings.

1. INTRODUCTION

With Norway being one of the 195 countries to adopt the Paris Agreement in 2015, there has been a notable increase in focus on environmental issues. In Norway, this went further with the publication of the governmental policy document “*The Green Shift – climate and environmentally friendly restructuring*”. The Green Shift is not isolated to this document, but creates a platform for both regulatory approaches and market incentives based on the policy document. It offers the term “friendly restructuring”, referring to a combination of a governing policy introducing stricter buildings codes and regulatory city planning based for reducing climate gas emissions. An example of such a combined regulatory and market incentive approach would be ‘Enova’. Enova is owned by the Norwegian Ministry of Petroleum and Energy, and provides support to building developers, owners and managers for improving the sustainability of their building stock outside the existing building regulations (Enova, 2013).

A focus on the construction and building sectors has seen one of the more crucial focuses in this overall strategy. The move towards “the Green Shift”, one of the most important measures is reducing emissions in the building and construction sector. In the case of Norway, this approach is already found in technical regulations and building codes for 2017 for low energy and passive houses (Lavenergiprogrammet, 2016). These types of measures combined with international sustainability initiatives for green accreditation and certification methods, like the

Building Research Establishment Environmental Method (BREEAM), help in the creation of a more holistic approach to further development of the sustainable built environment.

In Norway real estate developers, corporate real estate and public institutions are already beginning to address sustainability and green solutions in their building development projects and in Facilities Management (FM). Whilst some are adopting the likes of BREEAM (Collins et al., 2016) for their own portfolios, a focus on the development of Sustainable Buildings (SB) with or without a certification and its associated FM are key methods for the ‘greening’ of state owned real estate and ride the wave of the Green Shift. This process has also been driven by the research and development of Zero Emission Buildings (ZEB) by the Research Centre headquartered at the Norwegian University of Science and Technology (NTNU). Positive results have been achieved by setting up consortia with many partners and close cooperation between research, education, industry and private and public partners in the real estate industry (Hestnes et al., 2017). The overall goal of substantially in reducing climate gas emissions from the built environment, set new requirements to link and integrate planning, design, construction and FM in a life cycle perspective. The long use phase of buildings makes Sustainable FM (SFM) with operation, maintenance and refurbishment more important in the assessment of climate gases over a lifetime from cradle to grave.

We see that despite many private real estate and public institutions aiming to tackle the green challenges for their buildings, there is still a disintegration in terms of how different disciplines and elements of operation and design consider how best to tackle this from a lifecycle perspective. Whilst a full lifecycle consideration can benefit buildings in the longer term (Zuo et al., 2017, p.358) from the perspectives of adaptability, operations and maintenance, the degree which this is achieved and successful is variable.

1.1 Problem statement, research questions and methodology

Referring to our overall objective in developing more sustainable buildings (SB) and developing better models for SFM, the aim of this paper is to investigate the gaps that we assume exists between SFM and SBs with respect to new and transformed buildings and for portfolio management at the strategic and operational levels. We will be looking at how the building process with the development of SB and SFM can be organised into a more integrated approach considering both technical and non-technical aspects of sustainability.

A basic assumption in our case studies is that there needs to be coordinated information and communication between different management levels; strategic, tactical and operational, in developing SBs and for efficient and effective SFM in a life cycle perspective. For more background information regarding this assumption, see previous studies by Haugen & Klungseth (2017). With the aim of this paper being an explorative study, research questions were developed that would allow for the scope to produce indicative results given a small sample size. The broader scope for these questions along with the process behind procuring the sample can be found in the in the methodology later in this paper.

The paper will deal with these issues by addressing the following research questions:

- 1) What were sustainable goals for SB and SFM of the cases studied?

- 2) How were performance goals set and implemented at the strategic, tactical and operational levels of the case and what criteria did the cases use to evaluate their sustainable approach?
- 3) What were the gaps between integrated SFM and SB present in these projects, and what are possible measures for bridging the gaps?

The paper also deals with the development of a theoretical framework for exploring the gap between Sustainable FM and Sustainable Buildings. Our focus in this paper based on six exploratory case studies, led us to developing a multi-dimensional framework for analysing and bridging SFM and SB in development and construction projects as well as in asset management and FM. Students through semi-structured interviews accrued data collected for analysis with key personnel in these buildings such as Real Estate directors, Project Managers, Facilities Managers (FM's) and Operations Managers (OM), as well as technical information and other documentation supplied by the institutions. Core key performance indicators (KPI's) were collected during fieldwork and later analysed to reflect the mandate of the research questions. The data from the interviews and documentation are augmented using academic and practice literature for the most part from journals from 2000 to present.

As with any study of this context, it is not without its limitations. The study in this paper features six separate building studies selected from initially 12 buildings from a combination of higher education institutions and research buildings in Norway. The study also consists of new and existing buildings including two refurbishments. Whilst scope and depth of research is considered significant by the authors, the small building sample size nonetheless affects the external validity of the results. This is also the case with regard to the fact that the paper features cases limited only to Norwegian buildings. This why this research should be considered 'exploratory' in nature and the results 'indicative' as opposed to definitive in nature.

After describing each case profile, the sustainable infrastructure from the perspective of SB's and SFM will be presented. The paper will conclude by looking at the research questions through a discussion analysing the results from the perspective of the 'strategic', 'tactical' and 'operational' along with looking at the degree which they bridge the gap between sustainable public buildings and FM.

2. LITERATURE AND THEORY

When considering the research questions and scope of the study, it is important to define certain terms and concepts as they are considered in the context of the paper more broadly.

2.1 Sustainable development

When it comes to sustainable development, the most widely understood and used definition was given by the Brundtland report in 1987, which states that sustainable development is "*development that meets the needs of today without compromising the ability for future generations to meet their own needs*" (Brundtland, 1987, p.15). Although this platform provides a theoretical context to sustainability, it does not provide for specific indicators for sustainable development. In 1994 this was expanded upon by John Elkington who developed the now called 'Triple Bottom Line' for sustainable development (Elkington, 1994). This model addresses sustainability from three different perspectives, social sustainability,

environmental sustainability and economic sustainability. In the Norwegian context, the Brundtland definition provides an overall ‘mission statement’ for a green perspective, with more key performance indicators (KPI) another appropriate metrics being developed by academic and practice institutions.

For analysing sustainability in construction projects and buildings, we can use their three levels for analysis (as an example): Sustainable (or not) at an *operational* level, Sustainable (or not) at a *tactical* level, Sustainable (or not) at a *strategic* level.

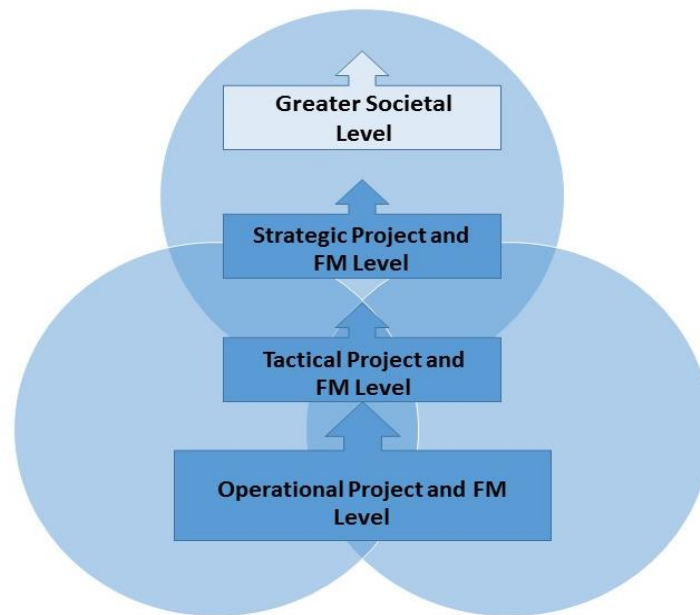

Figure 1. Assessment of projects must be based on all three pillars (the circles represents economy, environment and society) and at all levels (operational, tactical and strategic) normally used in construction projects and in facility management. (Illustration developed from Haavaldsen et al., 2014, p.10)

As illustrated in figure 1, the assessment of projects must be based on all three sustainability pillars (the circles represent the economy, environment and society) and at all three management levels (operational, tactical and strategic). The three management levels used in development of projects corresponds with organisational and management models used in construction of SB's and in SFM. Analysing and bridging the gaps between SFM and SB should be done with a clear understanding of the different management levels (strategical, tactical and operational)

2.2 Sustainable buildings

Whilst there is no commonly understood definition as to what constitutes a SB, there have been numerous attempts in both academia and practice to tackle as to what constitutes such a building. From an academic perspective, Berardi (2013) defined a SB as “*a healthy facility designed and built in a cradle-to-grave resource-efficient manner, using ecological principles, social equity, and life-cycle quality value, and which promotes a sense of sustainable*

community” (Berardi, 2013, p.76). A discussion as to what constitutes an SB also leads to looking at definitions and interpretations of the term ‘Zero Emission Building’ (ZEB). A definition of a ZEB is relevant as a ZEB is often the end result of, or the intended goal of a the Green Shift in the context of buildings, and is a key consideration in the development of an SB itself. In this study, the definition of a ZEB building is that which has been defined by the Norwegian Zero Emission Building Centre. On a conceptual level they view a ZEB as one with a “*greatly reduced energy demand, such that this energy demand can be balanced by an equivalent definition of electricity (or other energy carriers) from renewable resources*” (Hestnes et al., 2017, pp.16-17). The buildings evaluated in this study cannot be considered to be zero emissions by this definition, though an understanding as to the Norwegian definition of the term is contextually relevant.

2.3 Sustainable FM

When considering what constitutes a sustainable, low energy or zero emission building, it is also important to consider the context of FM. This is also relevant for the overall study due to the previously stated emphasis on the integration of SFM. Building assets provide the greatest opportunity for a positive sustainability impact that organisations either own or occupy (Nielsen et al., 2016, p.259). This can be achieved through effective management of these buildings as assets with the sustainable agenda as a core part of this strategy.

Whilst FM more generally was defined in the European Committee for Standardisations (CEN) EN15211-1 as “*the integration of processes within an organisation to maintain and develop the agreed services which support and improve the effectiveness of its primary activities*” (CEN 2006 cited in BIFM, 2017), this cannot be considered to also encompass the sustainable agenda for FM at present. In terms of how SFM differentiates, this can be in the context of FM including “*consideration not only of core business and support functions, but also relations within the local and global society as well as the climate and the eco system*” (Nielsen et al., 2010, p.3). This could manifest in FM considering the likes of energy and waste management, sustainable procurement and logistics in the context of broader building sustainability objectives. The current challenge however is to develop SFM further by applying sustainable development, building management criteria along with design and construction and sustainable integrated processes (Elmualim et al., 2009, p.95).

Nielsen et al. (2016) sum up in their article regarding measuring and managing sustainability in FM and Corporate Real Estate Management (CREM) that one should be “*context specific in the formulation of strategic goals and KPIs, as sustainability challenges as well as implementation possibilities and barriers vary between locations, buildings, businesses and organisations*”. Nielsen et al. (2016) also underline the need for applying a life cycle perspective when planning FM or CREM activities. Nielsen et al. (2016) also points out that further studies in FM “*should investigate whether and how the FM and CREM sector is developing into potential change agents for sustainable development on a societal scale to qualify policies and regulations in the field*” (Nielsen et al., 2016, p. 273).

Berker (2017) has looked into specific end-users perspectives when summing up experiences from ZEB pilot buildings with high energy ambitions (Berker, 2017, pp.152-153). There he addresses three main aspects that have characterised successful energy efficiency interventions for non-residential buildings. According to Throndsen et.al (2014) these aspects are of special

interest for our focus on examining and bridging the gap between SFM and SB's *"they combined different methods and addressed both technical and non-technical aspects of energy use. The organisation's management had created a context which favors energy efficient behavior"*. The findings from Throndsen et.al (2014) review of existing literature, where confirmed by evaluations of ZEB's pilot buildings, exemplified by the three success factors in the refurbishment project Powerhouse Kjørbo (Throndsen et. al.,2015, p.153): A project is *"a mix of well-coordinated technical and non-technical approaches, a devoted management, and a common project creating a shared interest in succeeding."*

2.4 Life cycle assessment

With an integrated approach to SB design and infrastructure, it is also important to reflect on the building's life cycle context. When discussing buildings lifecycles in the context of sustainability, we often hear of it in the context of 'Life Cycle Assessments' (LCA). According to Bribián *et al.* (2009), these assessments were designed for the development of environmentally friendly materials, products and infrastructure used when considering the whole lifespan of a building. Such assessments are particularly important for buildings due to their long life, complexity of components and the potential for multiple changes in their usage (Zabalza et al., 2009, p.2511). When looking at sustainable retrofits more specifically, Shah (2012) notes that life cycle considerations should be considered from the perspective of the embodied energy expended throughout the lifecycle of the building (Shah, 2012, p.188).

A consideration and understanding of the importance of emissions is also a key component of Life cycle discussions in SB's. Kristjansdottir (2017) for example points out that *"the low emission focus needs to become a natural part of every building and renovation project"* and *"if we look only at energy use and energy balances, while dismissing emissions, we get an incomplete picture of the environmental impacts"*. Both for managing sustainability in FM, and for developing new SB's and for sustainable refurbishment we have to base our analysis on life cycle thinking and LCAs for the recommended and applied technical solutions and management issues.

The standard EN15978:2011 "Sustainability of construction works" (CEN 2011), describes the life cycle of a building in four main stages; *Production, Construction, Use and End of Life*. An issue that is interesting for our study is the division into subcategories as illustrated in figure 2. What is also interesting from a SFM perspective is the detailed description of the Use stage into; Use, Maintenance, Repair, Replacement, Refurbishment, Operational energy use, Operational water use.

A1-3 Product Stage			A4-5 Construction Process Stage		B1-7 Use Stage							C1-4 End of Life			D Benefits and loads beyond the system boundary	
A1: Raw Material Supply	A2: Transport to Manufacturer	A3: Manufacturing	A4: Transport to building site	A5: Installation into building	B1: Use	B2: Maintenance (incl. transport)	B3: Repair (incl. transport)	B4: Replacement (incl. transport)	B5: Refurbishment (incl. transport)	B6: Operational energy use	B7: Operational water use	C1: Deconstruction / demolition	C2: Transport to end of life	C3: Waste Processing	C4: Disposal	D: Reuse, recovery, recycling

Figure 2: Life cycle stages of a building according to EN 15978, CEN (2011) Sustainability of construction works. Assessment of environmental performance of buildings. Calculation method. CEN 2011. EN 15978 (Kristjansdottir, 2017, p.70).

In this study focusing on the gaps between SB and SFM, the main focus will be on ‘B1-7: Use stage with Maintenance, Repair, Replacement, Refurbishment, Operational Energy use and Water use. Experiences and data from the use stages are important input to the planning and design of new buildings and for the assessment of the total environmental performance. In the production stage of a building, all emissions from the production of the raw materials, transportation to manufacturing sites, and manufacturing emissions are all accounted for in this context. Jelle et.al. (2017) points out that selecting the right building materials and technical systems, are more important than ever (Jelle et al., 2017, p.93). In order to achieve SB’s and a subsequent low environmental footprint, it is important to select materials with low embodied emissions, to reduce the materials used, to source local materials, to choose durable materials and technical solutions and to reuse and recycle materials.

From the Norwegian perspective however, Bygg21, an organisation consisting of public and private partners hoping to improve productivity and sustainability in the property industry, look at building lifecycles from more of a stakeholder perspective. They claim that mistakes, lower productivity and even accidents on projects are directly related to poor engagement with particular stakeholders at crucial stages of a buildings lifecycle (Bygg21, 2015a, p.2). They include stakeholders in their conceptual model from the owners, users, FM and even the public. For example, they advocate a role for users at the design stage in being involved with a ‘needs analysis’, but require a different role of these users later by involving them in room planning and even overall assessments during the life of the building life (Bygg21, 2015a, p.4).

2.5 A framework for exploring the gap between sustainable FM and sustainable buildings

Based on the ‘Green shift’ ambition for a substantial climate and environmentally friendly restructuring of the building and real estate sector, we have in this paper given short overviews and examples of state of the art research, applied recommendations and development of SB’s and SFM. This represents partly front end research and construction projects used to fulfill national strategies and goals to reduce the energy consumption in new and existing buildings. As described in the paper, there is not only a need for developing and managing energy efficient buildings and to lower the overall energy consumption, we also need to shift the focus to

develop solutions that reduce the climate gas emissions from a life cycle perspective. A way to explore and analyse the gaps between SFM and SB's, is to study the total ecological footprint for the use of a building, for a larger neighbourhood or for a larger urban area.

Our focus in this paper based on a number of practical case-studies done by a group of master's students at NTNU, has led us to designing a framework for exploring and analysing the gap based on a set of known models, pilot studies and knowledge from theory and practice regarding sustainability and sustainable development.

The multi-dimensional framework includes:

1. Assessment of buildings and projects must be based on the three sustainability pillars with a holistic view on environmental, social and economical sustainability (Brundtland 1987).

2. Analysing and bridging the gaps between SFM and SB's should be done with a clear understanding of the *different management levels (strategical, tactical and operational) in building projects and FM* CEN (2011), CEN (2012).

3. Life cycle assesments for new SB's and for sustainable refurbishment has to be based on analysing the ecological footprint and *emissions over planned life time periods* in addition to *energy use and energy balances* for the recommended and applied technical solutions and management issues.

4. A commonly accepted whole life building process model and a framework for planning, programming, designing, construction, handing over to the commissioning client, use and operation and maintenace with a focus on the different steps, processes and products that create the life cycle building process from "cradle to grave".

In our studies we relate our findings to the Norwegian "Next step" framework (Bygg 21 - 2015), comparable to the UK RIBA Plan of Work 2013 which is the definitive UK model for the building design and construction process.

3. THE SIX CASE STUDIES

The study takes the form of case study research with data collected from large public Norwegian buildings, with emphasis on higher education and research institutions. Master students researched these case studies in the autumn of 2016 as a part of their course module in SFM at NTNU. Six different case studies of the public buildings were selected according to the following criteria:

- Institutional buildings for higher education and research between 5.000-20.000 square meters
- New or refurbished buildings, up to five years since handing over the new or refurbished buildings
- Defined ambitious sustainable goals on a strategic and tactical level for the new or refurbished buildings
- A sample of buildings managed and operated by large Real Estate and FM organisations (four of the six cases) and a sample managed and operated by smaller Real Estate and FM organisations (two cases)

These common criteria were chosen to give useful input for NTNU's campus redevelopment, as the technical criteria is comparable to NTNU's existing building stock and future building projects while the criteria regarding sustainable strategies and operations should provide a state of the art approach for NTNU to emulate. Furthermore, these common denominators have revealed the different sustainability strategies and approaches employed, the criteria used to evaluate this, and how sustainability is implemented on the organisational levels of FM and the challenges and opportunities emerging in the projects.

The research participants were selected for their key roles in construction or in implementing the sustainable strategies. The participants were contacted either directly by students or through the network of the Center for Real Estate and Facilities Management at NTNU.

3.1 Case profiles

	Purpose	Year of construction	Sq.m.	Total portfolio (sq.m)	Energy usage (kWh/sqm/year)
Case A	Offices / Education	1910 (2016-)	17000	520000	183 (down from 217)
Case B	Offices / Education	2013	17000	520000	95 (1)
Case C	Offices / Private owner	2012	12000	12000	90,1
Case D	Library/ Study centre	1962 (2015-2016)	5500	582000	100
Case E	Hospital/ Education / Research	2013	17200	227000	127
Case F	Offices/Research /Laboratories	2013	7768	7768	70,7 (calculated)/ 140 (measured)

The total assets are calculated from both owned and leased real estate for owners and tenants in the cases. For cases C and F, the total asset area is for a single building.

Case A - This building is a Jugend style stone and masonry construction from early in the 20th century. This property serves as the main building of a large higher education and research institution, and is an important symbolic building in the Norwegian university sector. The building is undergoing refurbishment, but due to it being listed for conservation reasons, challenges emerged for improving its sustainability. Interviews have been conducted with the strategic real estate manager, two operations managers, and a building engineer.

Case B - University building constructed and owned by a public real estate organisation, and leased for the purpose of higher education. This building also has a grocery store on the ground floor, which further increases the demand for technical infrastructure. Construction was finished in 2013, and achieved a class B energy mark. Interviews were conducted with both former and current FM, in addition to the operations manager.

Case C - This building was constructed in 2012 as an energy efficient office building by a private company with a sustainable profile. Its core construction mainly consists of

prefabricated concrete elements. Photovoltaic (PV) panels have been integrated in the façade, producing an extra 15.000 kwh/year. The building is also certified with a class A energy mark. Interviews were conducted with a representative from main long-term leaseholder and operations manager.

Case D - This building is a part of an institution for higher education and primarily consists of auditoriums, workspaces for students, a library and common spaces. The building was refurbished in 2015/2016 with ambitions of achieving the classification of BREEAM 'Excellent'. This building has restrictions in terms of it being listed as an object fit for conservation. It's "Class 2 conservation" means that the overall architectural expression must be maintained, but that systems and objects that do not constitute as a major part of the architectural expression may be changed. The Project manager and the leader of project department in the organisation were interviewed.

Case E - This is a building owned by a regional hospital. Construction was completed in 2013, and it serves as a hub for developing and sharing knowledge of health services. It has also been certified as a passive house. Interviews were conducted with two operations managers in the FM section at the hospital.

Case F - This property is occupied by a national institution of research, and consists mainly of offices and laboratories. The building was built over the course of 2012/2013 to meet passive house standard. The building is constructed on a concrete fundament, designed to provide a similar look to a glacier in accordance with the profile of the organisation. The carrying infrastructure consists mainly of concrete and solid wood elements, and the building is a certified passive house. The manager of operations and operations engineer were the interview subjects.

4. RESULTS

The results from the case studies demonstrate differences in the approach used by the organisations with regards to how they tackle the issue of sustainability in their projects.

Each of the cases had a high focus on energy efficiency within their frame of opportunity, although their approaches differed with regard to how they approached it from both an SFM and SB perspective

4.1 Sustainable buildings

Applying Berardi's (2013) definition to what constitutes a SB, a mapping of the technical aspects of the building is needed, with regard to structure of the building, use of materials and technical equipment in the building.

The first observation from the cases shows that every project unsurprisingly had a firm eye on the thermal quality of their thermal envelope, as this was regulated through national building legislation. Furthermore, each case has an advanced ventilation system, containing systems for heating and cooling. In terms of LCA of building materials, this was mentioned as an important point in two of the new buildings, in addition to the refurbishment cases, especially regarding the external cladding and substructure. Case B is an interesting case in this respect. As they financed the project themselves, the cost focus was higher than in the other cases, and their

focus was on selecting materials with the best quality and value. Still, they managed to keep focus on keeping LCC low. Corte Steel was chosen due to low maintenance and architectural expression, and internal surfaces were chosen for their abilities of high resilience and low costs of operations.

As shown by these cases, a sustainable approach to these public buildings mostly placed a focus on energy efficiency, but placed less of a focus on, for example, LCA, embodied energy, waste disposal systems and a system to reduce spill water. While energy efficiency is a central factor in regards to sustainability, a holistic approach, as illustrated by the triple bottom line model, would also bring other factors into consideration.

Numerous incremental factors influence a buildings overall sustainability in a broader perspective, for example management of spill water, lighting and waste. These factors needed to be considered during early design stages. Only Case D had a sufficient system for repurposing spill water. The cases show that a sustainable system for a mixture of natural and produced lighting were prioritised, however in a few cases fluorescent lighting was installed, only to be switched out for LED lighting a year later. Furthermore, many of the cases experienced that waste management was insufficient, and had to be adjusted after a short period of operations.

The case which had the most thorough approach to sustainability is Case D (a refurbishment project), as they included most factors related to SB's into the construction, and further on into FM. Although the case had some negative experiences in handling the process and documentation, this shows the potential for using such tools. In this case it helped them in planning for ensuring sustainable solutions, processes and implementation, with positive results.

4.2 Sustainable Facilities Management

Regarding their systems for heating, cooling and ventilation, each of the cases had an integrated Building Management System (BMS). This reduces excess energy as balanced ventilation recycles excess heat and can be used as a tool for temperature adjustments. It also makes it simpler for the OM to make quick alternations, which is good both from a social and economic perspective, as it improves user satisfaction and control for the OM. Some of the users from the cases were experiencing problems with air quality, as this could be the product of issues with either heating, cooling or the grade of air exchange. For example in Case C, where users experienced high temperatures which were not a product of low cooling, but of a low exchange of air in the building. In buildings with opportunities for more user influence, for example in Case E and F, the users could open external windows or doors to temperate rooms to gain a more comfortable working environment, which greatly improves their satisfaction. Case F has accomplished this successfully, as their temperate zones reduces high fluctuations in temperature in the office landscape.

The new buildings had variable qualities in terms of adaptability, which could result in the overall quality of the building deteriorating faster as new needs emerges from the tenants. It becomes apparent that adaptability in terms of flexibility is not a priority and the builder doesn't plan for further add-ons to the building mass. However, in several cases the internal flexibility and generality has been taken into consideration with a high number of building sections, which leaves room for adjusting the internal environment.

Both Case E and F had ambitions of utilising spill products to other uses in the building, but this has not yet been implemented. An effective use of spill for example in multipurpose buildings such as Case B and F may severely reduce amount of energy delivered.

A recurring problem in several cases is that the simulated use of energy differs from the measured use of energy. In addition, at Case E and F, it was decided that they should be of passive house standards at a very late stage in the process. This put a lot of strain on the time consumed on re-drawing the technical systems. A few of the cases mentioned specific plans for implementing SFM on a tactical and operational level. Sustainable policies in these cases seem to be decided on a strategic level without any action plan for implementing this in the FM or user organisation.

5. DISCUSSION

When looking at the results from the cases in this study, it is important to reflect on the degree to which they touch on the three levels of organisational management in the context of both their building and associated FM.

In terms of approaches that focus primarily on the strategic level, these are found mostly in the context of the buildings themselves and less about the FM. With regard to Case B for example, the development of their buildings was done from a 'top down' perspective as they themselves both financed and spearheaded the project as a University. However, approaches similar to this, that focus on a project development or LCC perspective, also creep into the 'tactical', as the focus over the project moves into the procurement of high quality materials and sustainable technology in the context of maintenance planning. Some of the cases focus on the early development and operational considerations that targets the previously mentioned 'triple bottom line' factors, which due to its lack of KPI's could be considered to fit firmly in 'strategic' considerations on sustainable development. These focuses can sometimes be a part of the branding and corporate policies of organisations, which also impact the development of their buildings, such as in Case F.

Tactical approaches also feature prominently in the cases, with considerations coming from both the SB's and SFM. As mentioned previously, some of the buildings maintained control over the materials that they used in the development of their buildings. This choice is in itself an extension of their overall sustainability policy for their buildings. The prioritisation of sourcing these types of materials are a crucial part of tactical sustainability in a SB due to their importance in terms of securing the thermal envelope, and even providing possibilities for easier maintenance for FM's. With regard to tactical SFM, this has focuses on usability and adaptability in the studied cases. In this context the focus is on how adaptability and usability cannot just improve the user experience, but also the long term usability of the building as needs and maintenance change.

With regard to the overall model, the tactical level appears to offer the largest scope for sustainability and the most significant levels of overlap between SB's and SFM. Whilst building owners commission the policies and buildings that govern their practices, the maintenance and commissioning of these buildings require a sustainably orientated FM approach. It is a lack of consideration of FM teams, that also negatively influences the technical potential of the buildings in this study. Many of the cases report poor technical optimisation at

earlier stages of a buildings development, resulting in energy use hitting wide off their calculated target. This is also reflected in an LCA perspective, where some cases noted that cost / quality efficiency considerations had negatively impacted the operational efficiency of their building, as in Case B. Even though this is the situation for the selected cases for this study, this might not be transferable to cases with different criteria, and should only be used within the current scope. Factors like financing and insourced-/outsourced services might be a major influence on the SFM, and is worth a study in of itself.

6. CONCLUSION - BRIDGING THE GAP

The cases in this study have offered varying approaches as to how they have tackled their own commitments to the ‘Green Shift’, the extent to which they have ‘bridged the gap’ between SB’s and SFM has also been variable. In some of the cases, a multi stakeholder approach (often involving sustainability demands from users) resulted in a much clearer bridging of the gap between the building and its FM, mostly due to the impact on the OM levels that such an approach would require. The difference between organisation size and how this made a difference to SFM’s and SB’s was also evident. The cases indicate a broader implementation of bridging both elements in larger organisations, primarily due to a more solidified OM infrastructure and greater experience in buildings development. This however does not mean that such approaches are entirely absent in smaller organisations, although they can be considered to be less prevalent.

In conclusion, this study demonstrates that in the context of the Norwegian cases featured in this paper, there is currently little consistency in the degree to which the bridging of the gap between SFM and SB is achieved or attempted. This also speaks to the existence of an integrated approach to these and degree to which this is becoming more common in the development of sustainable buildings as well as the process surrounding this development. The degree to which this impacts on the success of building projects is also unclear, which in itself presents an opportunity for further research. Despite this, the way in which the organisations featured tackle this does present evidence suggesting a more lifecycle and stakeholder focused approach. This is the case with new and existing sustainable building projects, which over time could become a standard practice.

In terms of further applications and opportunities for this topic, the authors make clear the exploratory nature of this survey and the degree to which this represents a larger survey under development. The intention in the longer term is to further develop the framework to offer opportunities for analysis as well as provide scope to offer solutions to bridge the gap between SB and FM. The next step, both for this study and further research, is to open the sample to international study with building outside of Norway providing further external validity to the results and outcomes. This would ideally include one or two comprehensive case studies based on KPI’s for sustainable FM and sustainable buildings. There are also opportunities further up the road to learn from other published and ongoing research in this field, which in turn may also impact how the authors own research develops.

7. REFERENCES

- Berardi, U. (2013). Clarifying the new interpretations of the concept of sustainable building. *Sustainable Cities and Society*, 8, 72-78. doi:10.1016/j.scs.2013.01.008

- BIFM. (2017). Facilities Management Introduction. Retrieved from <http://www.bifm.org.uk/bifm/about/facilities>
- Brundtland, G. (1987). Our common future. Report of the World Commission on Sustainable Development. UN, Geneva, 208.
- Bygg21. (2015a). Neste Steg - I Kort Trekk (English: 'The Next Step - The Short Version. In Bygg21 (Ed.), bygg21.no: Bygg21.
- Bygg21. (2015b). Veileder for fasenormen «Neste Steg» -Et felles rammeverk for norske byggeprosesser. Retrieved from <http://www.bygg21.no/contentassets/ac0c77e4ec904c7a955525528b474b6c/veileder-for-fasenormen-neste-steg.pdf>
- CEN. (2011). Part 4: Taxonomy of Facilities Management - Classification and Standards.
- CEN. (2012). Part 7: Guidelines for Performance Benchmarking.
- Collins, D., Junghans, A., & Haugen, T. (2016). Green leasing in theory and practice: A study focusing on the drivers and barriers for owners and tenants of commercial offices. Paper presented at the CIB World Building Congress 2016, Tampere, Finland.
- Elkington, J. (1994). Towards the Sustainable Corporation: Win-Win-Win Business Strategies for Sustainable Development. *California Management Review*, 36(2), 90-100.
- Elmualim, A., Czwakiel, A., Valle, R., Ludlow, G., & Shah, S. (2009). The Practice of Sustainable Facilities Management: Design Sentiments and the Knowledge Chasm. *Architectural Engineering and Design Management*, 5(1), 91-102. doi:10.3763/aedm.2009.0909
- Enova. (2013). Formål. Retrieved from <http://www.enova.no/om-enova/36/0/>
- Hestnes, A. G., & Gustavsen, A. (2017). Introduction. In A. G. Hestnes & N. Eik-Nes (Eds.), *Zero Emission Buildings* (pp. 15-22). Bergen: Fagbokforlaget.
- Haugen, T. and Klungseth, N. J. (2017). "In-house or outsourcing FM services in the public sector: a review of 25 years research and development", *Journal of Facilities Management* , Vol. 15 Issue: 3, <https://doi.org/10.1108/JFM-06-2016-0022>.
- Jelle, B. P., & Wiik, M. K. (2017). The Right Materials: More Important Than Ever. In A. G. Hestnes & N. Eik-Nes (Eds.), *Zero Emission Buildings* (pp. 81-93). Bergen: Fagbokforlaget.
- Kristjansdóttir, T. (2017). Low carbon Solutions: The Key Driver. In A. G. Hestnes & N. Eik-Nes (Eds.), *Zero Emission Buildings* (pp. 69-76). Bergen: Fagbokforlaget.
- Lavenergiprogrammet. (2016, 19.02.16). Hva er et passivhus? Retrieved from <http://www.lavenergiprogrammet.no/artikkel/hva-er-et-passivhus/>
- Nielsen, S. B., & Galamba, K. R. (2010). Facilities management—when sustainable development is core business. Paper presented at the 9th EuroFM Research Symposium, EFMC 2010.
- Nielsen, S. B., Junghans, A., & Jones, K. (2016). Sustainability. In P. A. Jensen & T. J. Van der Voordt (Eds.), *Facilities Management and Corporate Real Estate Management as Value Driver* (1 ed., pp. 259-275). Oxon: Routledge.
- Shah, S. (2012). *Sustainable Refurbishment*. Sussex: Wiley-Blackwell.
- Thronsdén, W., Berker, T., & Knoll, E. B. (2015). *Powerhouse Kjørbo*. Evaluation of Construction Process and Early Use Phase. Retrieved from Trondheim:
- Zabalza Bribián, I., Aranda Usón, A., & Scarpellini, S. (2009). Life cycle assessment in buildings: State-of-the-art and simplified LCA methodology as a complement for building certification. *Building and Environment*, 44(12), 2510-2520. doi:10.1016/j.buildenv.2009.05.001
- Zuo, J., Pullen, S., Rameezdeen, R., Bennetts, H., Wang, Y., Mao, G., . . . Duan, H. (2017). Green building evaluation from a life-cycle perspective in Australia: A critical review. *Renewable and Sustainable Energy Reviews*, 70, 358-368. doi:10.1016/j.rser.2016.11.251

FACILITIES MANAGEMENT AND WASTE MANAGEMENT – BENCHMARKS AND PRACTICES NEED STREAMLINING

D. Crawley¹, T. E. Butt*¹, T. J. Francis¹, M. A. Nunns² and T. J. Allen³

**¹School of Architecture, Built & Natural Environments (SABNE), Faculty of Architecture, Computing & Engineering (FACE), University of Wales Trinity Saint David (UWTSd), Mount Pleasant Campus, Swansea, SAI 6ED. UK.*

²Environment Agency, Bromholme Lane, Brampton, Huntingdon, PE28 4NE. UK.

³Clean Harbors Surface Rentals, 12260 Donop Road, San Antonio, TX (Texas), 78261. USA

Email: t.e.butt@outlook.com / t.e.butt@uwtsd.ac.uk

Abstract: The connection between Facilities Management (FM) and the Waste Management is not widely recognised in any business. The same applies to the National Health Services (NHS) in the UK. In Wales, NHS has seven health boards with hospitals located throughout the country. Inconsistencies and lack of coordination exist in the relationship between the waste producer (NHS hospitals), FM (onsite waste managers), and the waste contractor/collector, which results in less efficient waste management. NHS Wales is employed as a case study to investigate waste management practices on hospital sites and a conceptual framework is outlined that can help produce a more standardised system for the organisation. One of the seven boards is selected, which has nine hospital sites for which primary data on waste amounts, types, segregation, and collection arrangements are compiled in a quantitative manner. For the remaining six boards' hospitals, the data is collected via a questionnaire with semi-quantitative approach. Freedom of Information (FoI) approach is additionally applied as a third. The data collected from the three approaches is systematically collated and compared against each other identifying common denominators, discrepancies and associated reasons. Thereby, formulating a baseline which can lead to develop a standardised system for FM that can help the relationship between NHS hospitals and waste contractors/collectors.

Keywords: Facility Management (FM); Facilities Management (FM), National Health Services (NHS), Waste Management.

1. INTRODUCTION

1.1 Background

NHS (National Health Service) Wales, since its establishment, has evolved not only to meet its ever growing UK population but also the rising numbers of over 60-year-olds where more complex needs are evident along with advances in new treatments and technologies.

“The number of people aged 60 and over is projected to increase from 14.9m in 2014 to 21.9m by 2039. As part of this growth, the number of over-85s is estimated to be more than double from 1.5 million in 2014 to 3.6 million by 2039” (NHS, 2017).

To place the size of NHS Wales' business into perspective, Wales has a population of just over 3 million and its healthcare services provided over 23 million contacts with patients in 2015 or an average of over 63,000 a day across its primary, secondary, tertiary and community care services (NHS, 2017). The vast scale of business within the NHS and its inevitable impact on the environment, specifically with regards to the waste that it generates, calls for robust systems to manage them. NHS organisations would, therefore, be dependent on FM to put effective systems in place to enable control of the waste and ideally to work in close collaboration with

waste collectors in their approach to manage waste and minimise its impact on the environment in a cohesive, integrated manner.

FM is most commonly spoken about in the context of property and associated building services which is more often referred to as “Hard FM”. FM has though absorbed a range of “softer” services within its remit (e.g. catering, cleaning, security, waste management etc.) and has now become increasingly multifaceted, particularly since acceptable standards and the user's expectation have risen, and the innovative technological developments have taken place. FM functions can be seen right at the heart of operational services in organisations. FM as a department has often been considered as an unavoidable cost or even a burden to the bottom line of an organisations budget. As time has passed, FM is now being acknowledged more for its importance as a professional role and being appropriately recognised for the value it does and can bring to support the strategic aims and objective of an organisation.

FM in any organisation provides services through a myriad of functions which need to be delivered in the right volume, at the right time and in the right place. They need to represent good value for money and be coordinated in such a way that that the primary functions of the organisation can run smoothly and safely. These principles of FM apply not least to waste management, where there are legislative requirements not only relating to waste but also considerations for infection prevention, transportation of waste and environmental sustainability; all of which needs to be met within a tight budgetary envelope.

The connection of FM and the impact it can have with regards to waste management is not widely recognised in many sectors of commerce and industry. The public health services in the UK are no different. In this paper, the NHS Wales is employed as a case study to explore waste management practices on hospital sites. NHS Wales has seven health boards and three NHS Trusts with hospitals and associated properties located throughout the country. As a Facilities Manager working within NHS Wales, it is essential to have a thorough understanding of the activities within the remit to allow services to be managed effectively.

1.2 Problem statement

Hospitals within NHS Wales have a duty to report on waste management performance, based on the data collected on waste arising. The waste management performance comprises of various activities, such as waste categorisation, waste segregation waste collection, waste measurement and recording, and benchmarking. Although variations are present in all the aforesaid activities from one hospital to another, the two more crucial ones are waste measurement methods and the associated benchmarking as they directly influence the degree of accuracy and confidence in reporting on waste management performance of NHS Wales. Therefore, the problem is that these two activities need to be streamlined throughout the organisation in Wales to improve environmental performance specifically in connection to waste. This problem is compounded by the inconsistencies experienced in the lack of coordination in the relationship between the waste producer, the NHS, and the waste contractor/collector.

The far reaching impacts of the aforesaid issues are that managers with the responsibility for waste are not able to as effectively manage because they are not in a position to confidently gauge, assess, and evaluate their waste arising. Consequently, this does not help NHS Wales

to comprehend and control their waste reduction trajectory to meet national targets outlined in “Towards Zero Waste” (TZW) (Welsh Government, 2010).

1.3 Aims and objectives

This study aims to investigate current waste management practices of NHS Wales in order to identify, define and evaluate variations in these practices and associated benchmarks; thereby formulate recommendations to enable FM to standardise the benchmarks of waste measurements and unify the practices throughout the organisation. The aim is managed to be achieved via the following key objectives:

1. Establish the role of FM in NHS Wales specifically in connection to waste management.
2. Assess current methods in NHS Wales for estimating waste produced on hospital sites, thereby, also identify good and poor practices, and associated implications.
3. Determine barriers to sustainable waste management on hospital sites including evaluation of waste measurement systems and associated benchmarks.
4. Design methods to underpin objectives 2 and 3 above, such as develop a questionnaire and carry out field experiments.

2. CURRENT POSITION

2.1 NHS Wales structure implications

NHS Wales in 2009, underwent a complete reconfiguration of health care organisations which led to amalgamations of 22 Local Health Boards and 7 NHS Trusts, resulting in just 7 Health Boards and 3 NHS Trusts. This streamlining of resources gave rise to some additional opportunities from closer working relationships and joint procurement mechanisms. This consortium approach when applied to waste management development and contracts management offered many advantages especially since Wales is a small country. One may envisage that in some circumstances where Welsh health organisations generate large volumes of a common waste stream, there could be a joining together in a single contract to benefit from economies of scale and to drive down the overall cost, like the case of the successful joint clinical waste contract in Wales. However, on the contrary, for other waste streams such as a general (residue) waste, it has not been successful and collaborations have proved prohibitive mainly due to regional availability of services. In such cases, waste producers often need to seek their own contracts or alternatively pair up with neighbouring health organisations in a joint contract arrangement, either with a private contractor or indeed by appointing their Local Authority (LA) to make the waste collections.

Joint working between LA and their partners, including health boards and NHS Trusts, is a legislative requirement in Wales under the Social Services and Well-being (Wales) Act 2014 (Welsh Government, 2014). While there are benefits of shared management structures between two different organisations, it can cause a conflict of interest for NHS organisations when the decision needs to be made as to whether to procure in partnership with the LA or to remain united with a national NHS contract.

2.2 Waste measurement and benchmarking - NHS Wales

In NHS Wales the benchmark used in reporting on estates and facilities performance is the Estates and Facilities Performance Management System (EFPMS). This system is used to report on a wide range of performance data from occupied floor areas to catering costs and waste generation. England, Scotland and Northern Ireland have a comparable reporting mechanism for reporting annual performance to their respective Government bodies. For Wales, EFPMS has specific data definitions for each performance indicator. The data definition describes how each of the indicators should be calculated to enable benchmarking to be comparable. Where waste amounts are not provided by the collectors for whatever reason, EFPMS mandates a protocol to estimate the waste amounts as quoted below:

“Where the waste is determined by volume, an assessment will be required to convert to weight in tonnes. (e.g. average weight of bag x number of bags per annum). In the absence of more accurate figures, typical ratio's of 10 Cu.m of bin volume = approx. 1 Tonne of waste (or 1 m³ volume = 100 Kg waste) might be used” (NHS Wales Shared Services Partnership (Specialist Estates Services), (2015).

Given the numerous possible variables that could affect the density of waste it is reasonable to consider that the EFPMS recommended constant figure of 100 kg/m³ of bin would lead to an inaccurate waste weight report. The only indicator that the (residual) general waste rates have changed, would be a decrease or increase in the number of bulk bins that were routinely filled to full capacity. A secondary purpose of EFPMS is to provide a benchmarking tool for FM to act as an essential means to inform on processes to ensure continuous improvement, identifying any poorly performing areas.

Fifty percent of NHS Wales Health Boards however favour using the Waste Reduction Action Programme (WRAP) “Business Waste Weights Calculator” to generate waste arising data because of the belief that it provides more accurate reporting. The WRAP calculator uses formulas to take account of the varying densities of different waste types and different volumes of waste collection containers. This means that the approach to measurement is not consistent and which in turn devalues the benefits of benchmarking and leads to less robust decision making to improve the performance of waste measurement, and eventually waste management.

3. RESEARCH METHODOLOGY

In this study the research methodology comprises three main methods to collect and process data to derive results. These methods are:

1. Field experiment – Quantitative, primary data
2. Waste Manager Questionnaire - Quantitative and qualitative, primary data – target group Waste Managers
3. Freedom of Information (FOI) Request – Qualitative, secondary, descriptive data – target group the Welsh Local Authorities (22 in number)

3.1 Field experiment - waste sampling

With a specific focus on general residue waste, a field experiment is conducted as part of the research to test if an average weight could be established for standard bin sizes to increase accuracy where accurate data was otherwise not available. The findings could then also be compared with existing measurement systems to validate their accuracy. The target for this experiment was one 1280 litre bin for collection on 9 different hospital sites within the identified health board.

The bin contents were weighed on 4 separate occasions over a 4 month period totalling 36 samples. Each weighing event was completed just prior to a scheduled collection to ensure the bin is in an entirely full condition. For the field experiment method, the definition of a full condition is that the bin is as full as it could be and still able to close the lid properly. The method of data collection is to decant the bin of contents and using a calibrated commercial electronic scale, weigh in kilogrammes each of the bags to two decimal places. See Figure 1.



Figure 1: Waste bags decanted from bins in order to be weighed (by the author, March, 2017).

The number of bags, the weight of individual bags, and the total weight is calculated along with notes taken from any other observations which might prove valuable when later evaluating the data. For example, identify any inappropriate composition of the waste contents or the extent to which the waste is compacted. The recorded data is then logged using a simple spreadsheet, where the data is analysed to produce quantitative, primary results.

3.2 Waste evaluation questionnaire

Having established an understanding of actual or real average waste data, it helped questions in the questionnaire to focus on the fundamental differences in waste management approaches of the different health boards. This, in addition, helped to formulate some recommendations as potential solutions that would be compatible across NHS Wales as a whole. The questionnaire aimed to:

- gauge the Waste Managers (WM) confidence in the accuracy of waste weight
- assess how the health boards measure the waste weight
- determine where their outcomes stand compared to each other including those found in the field experiment
- and finally listen to the respondents suggestions for improving benchmarking.

3.3 Freedom of Information (FOI) request

Established from the literature research, Local Authorities (LAs) in Wales co-collect waste from the kerb side and commercial sites using the same vehicle on the same route. They do however, have to report commercial waste separately, so it stands to reason that they should have a method, or a means to do so.

Substantiating the method that LAs in Wales use to calculate the weight of the waste that they have collected, for the purpose of monitoring their waste performance, is linked to understanding the scope they may have to support businesses and the NHS in particular with their own waste reduction strategies. The LAs were asked specific questions to test whether they operate co-collections of waste and where they did, further explain their methods for measuring these waste streams separately. Finally the LAs were inquired about their ambitions for the use of innovative data collection systems in the future to support business manage their waste more effectively.

4. RESULTS AND DISCUSSION

The three methods of the research methodology demystified the actual activities associated with waste. This leads to devising some simple but effective solutions to streamline waste management practices and benchmarks, which are described below categorically:-

4.1 Field experiment

The field experiment method efficiently proved that it could provide accurate estimates of waste weight purely based on bin volume and that these remained fairly consistent over the 4 month sample period. Two of the nine bins in the experiment could be seen as outliers, as in one case there was very poor segregation of waste at the source, and in the other, the waste was hydraulically compacted. The remainder of samples had a very similar average weight throughout the experiment.

It was further deduced that the variation in densities or compaction factors (if any), adopted by different hospital of NHS Wales can grossly affect the estimated weight of a bulk bin, if not adjusted accurately. This is particularly significant as an inaccurate estimate for a single bin, extrapolated over a full year for hundreds of bin collections coupled with the variables that affect each of them locally, will lead to inconsistent and inaccurate reporting nationally. It can be concluded that using a predetermined weight of waste by volume (such as the method used generally in NHS Wales e.g. EFPMS, WRAP, etc.) can result in less accurate calculations. Approaches, like demonstrated in the field experiment method, would allow densities of bin waste to be adjusted, leading to more accurate results. To provide assurance that the measurements in use remain accurate, periodic ongoing audits would be essential.

Any measurement model would need robust waste management processes to be embedded to minimise fluctuations in waste densities. The density or compaction rate of the bin can be affected by many variable factors. During the field experiment the following was observed as possible influencers:-

The fullness of a bulk bin or the definition of a completely full bin – just full with the lid able to close or lid just unable to close.

The size of the waste bags that waste is segregated into - different sized bags or compaction rate of individual bags will have a lesser or greater density because of its volume.

Differing volumes of bulk bins used - various size bins may have a lesser or higher density because of its volume. That is because in larger bins the weight of waste above compacts that below it to cause it to become denser.

The composition of waste within the bin – the effectiveness of waste segregation at the source will impact on the density of the waste by volume.

The frequency of collections – the longer the waste sits in the bulk bin, the more it will naturally compress/compact under its own weight and become more dense, allowing further waste to be added later or “topped up” before collection.

The way waste is collected at the initial segregation point – human behaviours will vary resulting in the waste being decanted into fewer bags during collection leading to variations in density.

Hydraulic compression of waste – some sites / hospitals use hydraulic compression systems to reduce the volume of waste, increasing its density, so the weight of the bulk bin will be higher.

Seasonal variation – some sites may be subjected to changes in their activities at different times of the year and where the types of waste generated may differ, the waste density in the bulk bins will be affected.

Where bins costs are charged for each bin lift e.g. by volume rather than by weight, it is clear that certain practices such as compaction may lower the cost of disposal per kilogramme. This must be taken into account if benchmarking the cost of a waste collection service, i.e. is the service charged by weight or volume? Although saving money by compacting waste to take advantage of such a ‘density driven’ contractor, in terms of sustainability of waste management practices it does not play any role in improving waste management performance nor contributing positively to the zero waste strategy, unless recycling and reuse options are still fully applied.

4.2 Waste evaluation questionnaire

The waste evaluation method proves to be most valuable in understanding the waste concerns in FM. There was a general acceptance amongst Facility Managers / Waste Managers of NHS Wales that whilst they do in some instances receive waste data from waste collectors but their confidence in its accuracy is not high. Likewise, when they have to carry out calculations to estimate waste weight data where it is not available, a unified methodology would greatly enable more meaningful waste measurement.

4.3 Freedom of Information (FOI) request

Among the 22 Authorities, 18 responded to the FOI before the designated deadline i.e. 88% response rate. A specific interest of the study has been to establish if the increasing trend reported by WRAP (WRAP, 2013) to co-collect both kerbside and commercial waste on the same vehicle was applicable to Wales. To establish this, three questions were asked with their corresponding analysis as follows:-

- 1. Does your organisation co-collect general waste (also called “residual waste”) from both households and commercial sites (private or public businesses) using the same collection vehicle on the same round/route?***

In Wales, of those that responded, the figure was found somewhat lower than the WRAP reported figure of 43%, as 39% or 11 out of the 18 LAs answered no. This number becomes even less significant when it is considered that this method is only used in the most remote areas of Wales, and so only represents a minuscule part of their total waste collection activity.

The next step is to establish if the methods, the LAs use to determine the difference between the weights of kerb side and commercial waste, could be utilised to support the needs of NHS Wales with accurate waste weight data as part of their contract. A second follow-up question therefore asked is:-

- 2. Can your methodology be explained please for determining the actual weight of general waste from domestic households versus that collected from commercial sites where the waste is co-collected from both using the same collection vehicle on the same round/route?***

Of those who did co-collect, the given methods for determining the difference between weights of kerb side and commercial waste, offered little assurance of accuracy due to the range of likely outcomes each would have concluded. The methods for estimating the waste weights of commercial waste collected can be summarised as:

- Periodic sampling of trade waste weights to set an average weight.
- Given the low volumes collected commercial waste is disregarded in any calculation.
- No method used
- Make a calculation of 0.13kg per litre volume collected
- Make a calculation of 0.07kg per litre volume collected
- Make a calculation of 0.06kg per litre volume collected

Only 3 of the 18 LAs provided the weights per litre of waste collected for measuring performance. This is depicted in Figure 2 which shows the estimated weight per 1280 litre volume bulk bin for comparison against other methods i.e. EFPMS, WRAP and authors sample data.

It demonstrates that even when the measurable methods are employed by LAs in Wales, they can not offer a consistently robust means to support NHS Wales with accurate waste weight data. In addition, when LAs methods are considered with other commonly used waste weight estimation systems in NHS Wales, the variation in waste data may exceed even 54%.

Waste Field Experiment

Variations of weight estimations for a 1280 litre bulk bin

	Estimated weight densities per Bin (Tonnes)	Example number of annual bin lifts	Equates to estimated total weight (Tonnes)
	A	B	C
EFPMs (In use by 50% NHS Wales)	0.128	208	26.62
WRAP (In use by 50% NHS Wales)	0.102	208	21.21
Authors Sample (From field experiment)	0.087	208	18.10
Local Authority 1 (From FOI)	0.166	208	34.52
Local Authority 2 (From FOI)	0.089	208	18.63
Local Authority 3 (From FOI)	0.077	208	15.97
			54% Variation

Figure 2: Variations in estimated waste weights using different methods.

The final FOI question is set to assess LAs ambitions to improve their reporting systems for the future with any of the innovations that are currently being developed both nationally and internationally:

3. ***Has your organisation considered any innovative means to identify commercial general waste weight at collection point for reporting purposes, for either the customer or your own organisation reporting mechanisms and if not please indicate why these have not been considered? Such innovative means might be bin lift weighing systems or bin weight sensors etc.***

There appears to be a clear conflict of understanding between the 22 LAs in Wales and the WRAP report where it was reported that a key driver for moving towards co-collections of waste is cost reduction. This is found to be true in remote rural areas where collection points are sparsely dispersed, but in built up areas, LAs report that it would not be cost effective. Prohibitive costs are also cited by LAs as the reason for not providing additional systems on the collection vehicles to weigh waste as it would not benefit them to have more accurate data. LAs dismiss the idea that businesses would want this data in any case, which is, in fact contrary to the view of NHS Wales Waste Managers who have reported in the waste evaluation questionnaire where they consistently call for more reliable data.

5. CONCLUSIONS AND RECOMMENDATIONS

This study reinforces the purpose of the FM role in NHS Wales specifically in connection to waste management. Validation of benchmarks and unification of waste management practices, despite its relatively simple principles, has room for improvement. This is particularly evident in areas where sufficient leadership, guidance, accountability and integration have not been considered. To mitigate this in NHS Wales, the health boards clearly need to work together to develop plans to ensure that the quality of waste measurement is improved by unifying their practices and validating their benchmarks. This can be achieved by agreeing on a course of

actions to result in a consistent approach to measuring waste. This study has been the first in NHS Wales to explore the effectiveness of benchmarking weight measurements. Furthermore, this study, despite its limitations, has set the scene for further discussion which of course is one of its objectives.

As a part of this study, open and transparent conversations have taken place with NHS Wales colleagues. This research project has sparked a common interest to take this study work even further. In order to gain a more effective standardisation throughout NHS Wales, now the whole Organisation in general and the Waste Consortium team in particular are keen to review the way the Organisation measures its waste arising and that how it executes its waste management practices and benchmark implications.

WRAP have devised a calculator that needs to be updated to include accurate waste bin densities at locally specific level to assist with calculating the total waste weight. NHS Scotland have already developed a similar version (NHS Scotland, 2017). What remains unavailable in NHS Wales is a holistic framework that brings together waste arising data from a number of hospital sites within a given Health Board or Trust not only to enable data compilation and interpretation in one place but also assist with the development of meaningful benchmarking specific to the Board or Trust. Finally, this will need to be rendered NHS Wales wide and later, ideally speaking, NHS UK wide.

The proposed framework will, additionally, assist in enhancement of the environmental performance of FM specifically in the waste management context. Furthermore, supporting the principles of NHS's policy for transparency to share information, learning and continuous improvement; this study brings out areas for further research with the idea of achieving zero-waste status. Whereby 'Towards Zero Waste (TZW)' is an overarching waste strategy of Wales aiming for becoming a high recycling nation by 2025 and eventually a zero-waste nation by 2050.

Note: The content of the paper reflects on views of the authors, and not necessarily that of their employer organisations.

6. REFERENCES

- NHS Scotland (2017). *NHS Scotland Waste Prevention and Re-use Guide*.
- NHS Wales Shared Services Partnership (Specialist Estates Services), (2015). Estates & Facilities Performance Management System Data Definitions and Completion Notes 2015 / 2016. www.howis.wales.nhs.uk. [Accessed 9 Mar. 2017].
- Nhsconfed.org. (2017). *Key statistics on the NHS - NHS Confederation*. [online] Available at: <http://www.nhsconfed.org/resources/key-statistics-on-the-nhs> [Accessed 25 Mar. 2017].
- UK Government, (2014). Social Services and Well-being (Wales) Act 2014. [online] Available at: http://www.legislation.gov.uk/anaw/2014/4/pdfs/anaw_20140004_en.pdf [Accessed 15 Mar. 2017].
- Welsh Government. (2010). *Welsh Government|Towards zero waste*. [online] Available at: http://www.gov.wales/topics/environmentcountryside/epq/waste_recycling/zerowaste/?lang=en [Accessed 15 Mar. 2017].
- Welsh Government. (2015). *Welsh Government|Well-being of Future Generations (Wales) Act 2015*. [online] Available at: <http://gov.wales/topics/people-and-communities/people/future-generations-act/?lang=en> [Accessed 6 Mar. 2017].
- WRAP (2013). *Bulk density and apportionment of C&I waste*. 1st ed. [ebook] WRAP, p.5. Available at: http://www.wrap.org.uk/sites/files/wrap/LA_apportionment_tool_userguide.pdf [Accessed 18 Mar. 2017].
- WRAP (2017). *Business Waste Weights Calculator*. [online] Available at: <http://www.wrap.org.uk/sites/files/wrap/Business> [Accessed 12 Mar. 2017].

AN INPUT-OUTPUT-BASED HYBRID (IOH) MODEL FOR COMPUTING INITIAL AND RECURRENT EMBODIED ENERGY OF RESIDENTIAL AND COMMERCIAL SECTORS

M. K. Dixit and S. Singh

Department of Construction Science, Texas A&M University, College Station, TX, USA

Email: mdixit@tamu.edu

Abstract: Buildings consume approximately 48% of global energy each year in their construction and operation alone adding proportionally to global carbon emission. In order to optimize the energy and carbon footprint of a building, assessing its life cycle energy usage by incorporating embodied and operating energy is important. Embodied energy is the total energy embedded in a building's construction, maintenance, replacement, and demolition. Embodied energy consumed through various products and processes used in a building's initial construction is called initial embodied energy. When occupied, operating energy is consumed in operating the building throughout its life cycle in the processes of air-conditioning, heating, lighting, etc. While in use, the building also undergoes periodic maintenance, repair, and replacement activities further consuming recurrent embodied energy through the use of products and processes. For comprehensively assessing and optimizing total life cycle embodied energy both the initial and recurrent embodied energy must be quantified. Although a consensus is lacking in literature over which method is apt, an input-output-based hybrid (IOH) method is considered relatively complete. In this study, we use the latest input-output (IO) data and develop an IOH model for the United States' economy to quantify the embodied energy intensity of residential and commercial sectors. The residential sector's intensity is calculated for single and multi-family structures, whereas commercial sector's intensity is quantified under the categories of healthcare, educational, and other commercial structures. We also calculate the recurrent embodied energy for residential and commercial sectors. Finally, we discuss and compare the calculated values with those reported by similar studies.

Keywords: Embodied energy, recurrent embodied energy, facilities management, maintenance, life cycle energy.

1. INTRODUCTION

Buildings use approximately half of global energy supply annually in their construction, operation, and maintenance (Baum, 2007; Dixit, 2017). This energy use may be much higher if the energy embodied in building construction and maintenance is completely accounted for (Dixit, 2017). Because a majority of this energy use includes fossil fuel-based sources, buildings also contribute significantly to carbon emissions (Crawford, 2004; Monahan & Powel, 2011). For instance, the building sector in the United States caused nearly 40% annual carbon emission in 2009 (Dixit et al., 2013; Thomas et al., 2016). Similarly, approximately 30-40% global carbon emission originates from the building sector each year (Chew, 2016; Dixit et al., 2016a). Like embodied energy, this carbon emission may increase significantly if all energy and non-energy carbon emission is accounted for. For instance, carbon assessment studies conventionally utilize energy usage to compute the emission of carbon based on fuel-specific carbon factors (Monahan and Powel, 2011). Such assessments, however, may exclude other non-energy carbon emissions such as those occurring during the manufacturing processes of building materials such as cement (Dixit et al., 2016b).

The total energy consumed by a built facility over its useful life consists of embodied and operating energy (Thomas et al., 2016; Stephan and Stephan, 2016). Embodied energy is the

energy embedded in all products and processes used by a facility over its service life (Dixit et al., 2015; Thomas et al., 2016). When a facility is designed and constructed, the sum of all energy embodied in materials (building materials, assemblies, equipment, etc.) and processes (e.g. construction, fabrication, transportation, consultancy, administration etc.) used in its construction is termed its initial embodied energy (IEE) (Crawford, 2004; Langston & Langston, 2007). When in use, the facility undergoes maintenance and repair, replacement, and major renovation activities, which also require materials and processes each of which contains embodied energy (Vukotic et al., 2010; Dixit et al., 2016b). The sum of energy embedded in these materials/products and processes used in the facility's maintenance and replacement is called recurrent embodied energy (REE) (Rauf & Crawford, 2015; Stephan and Stephan, 2016). At the end-of-life stage, when the facility is demolished, the energy consumed in its demolition, waste sorting and hauling, reuse, and recycling is known as demolition energy (DE) (Crawford, 2004). The sum of IEE, REE, and DE is known as the life cycle embodied energy (LCEE) of the facility (Crawford, 2004; Stephan and Stephan, 2016). When occupied, facilities also use operating energy in operations such as air-conditioning, heating, lighting, operating facility equipment, etc. (Ding, 2007). Assessing embodied energy is more complex and difficult than operating energy due to data availability issues (Ristimaki et al., 2013; Thomas et al., 2016). A lack of a standard method to calculate embodied energy in a consistent and complete manner also makes embodied energy assessment difficult (Dixit et al., 2013; Ristimaki et al., 2013). This study focuses on embodied energy and proposes an input-output-based hybrid (IOH) method to compute the energy embodied in a facility's initial construction, maintenance, replacement, and major refurbishment processes.

2. LITERATURE REVIEW

The embodied energy of a building is composed of a direct and an indirect energy component (Crawford, 2004; Dixit et al., 2015). The direct energy represents energy consumed directly in onsite and offsite construction, transportation, and other related processes (Crawford, 2004). For instance, fuel consumed by construction vehicles and electricity used by construction equipment and tools represent direct energy usage. The indirect energy component covers the energy embodied in building materials, assemblies, and equipment, installed in a facility (Crawford, 2004; Vukotic et al., 2010). Each material, assembly, or equipment consumes considerable energy in its manufacturing and delivery to a construction site, which must be counted towards the facility's embodied energy (Dixit et al., 2016b). Accounting for the direct energy component is simpler than the indirect energy due to a lack of energy use data (Crawford, 2004; Langston & Langston, 2007). For instance, to compute the energy embodied in concrete, the energy used by a concrete truck is quantified along with the embodied energy of raw materials such as cement, aggregates, water, admixtures, and sand. To calculate the energy embodied in raw materials such as cement, the energy used in limestone extraction, transportation, main manufacturing processes, and transportation must be covered. In addition, the manufacturing energy of machines and vehicle used in cement production must also be accounted for (Dixit et al., 2015) (See Figure 1). One can keep on going back in the upstream of manufacturing raw materials to cover major and minor energy inputs. With each upstream stage, it becomes increasing complex and difficult to trace energy inputs (Crawford, 2004; Dixit et al., 2015). Figure 1 illustrates the direct and indirect energy components and the complexity of assessing indirect embodied energy.

The direct and indirect energy components include a range of renewable and non-renewable energy sources such as electricity, coal, natural gas, and petroleum (Crawford, 2004; Dixit et

al., 2014). In addition to mechanical energy, the direct and indirect energy must also include the energy consumed by human labour, as some of the industry sectors such as construction and manufacturing are quite labour-intensive (Cleveland & Costanza, 2008). The embodied energy calculations must also ensure that the energy embodied in annual capital investment by industry sectors is included (Cleveland & Costanza, 2008; Dixit, 2016). As illustrated in Figure 1 and discussed in this section, quantifying embodied energy completely and reliably is complex and very data-intensive.

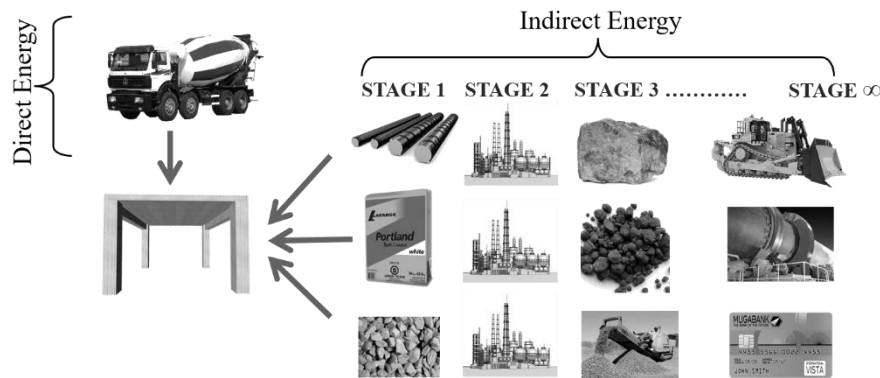

Figure 1: Direct and indirect energy components of embodied energy

2.1 Embodied energy calculation methods

Among commonly used methods to quantify embodied energy include process-based, input-output (IO)-based, statistical, and hybrid analyses (Ristimaki et al., 2013; Dixit, 2017). Each of these methods uses different data and covers a different system boundary (Ristimaki et al., 2013). A system boundary defines what is included in and excluded from an embodied energy calculation (Dixit et al., 2013). A wider system boundary covers an extensive system of most major and minor energy inputs. The available embodied methods cover varying degrees of embodied energy inputs (Nassen et al., 2007; Rauf and Crawford, 2015). For instance, a process-based method calculates embodied energy by collecting actual energy use data for all major construction, transportation, manufacturing, and administration processes (Stephan and Stephan, 2016). Collecting such process data becomes difficult after a certain point in upstream (Nassen et al., 2007). At that point, the system boundary is truncated resulting in an incomplete embodied energy calculation (Stephan and Stephan, 2016). Although reliable, a process-based calculation remains highly incomplete (Dixit, 2015b). An IO-based calculation utilizes economic IO data of monetary transactions between industry sectors of an economy and translates these transactions into energy flows using energy tariffs (Crawford, 2004; Dixit et al., 2014). Although IO-based methods cover a much wider system boundary than process analyses, their results may lack reliability due to using unreliable energy tariffs (Dixit, 2015). Each industry sector pays different prices for fuel and electricity, which, if under or overestimated, could significantly affect an IO-based calculation (Acquaye, 2010; Dixit, 2015). In addition, IO accounts are constructed based on the assumption of proportionality and homogeneity of industry inputs, which may not be accurate, as different products manufactured by an industry sector may require different input mix (Crawford, 2004; Acquaye, 2010). IO-based analyses may also include a double-counting error, which could add further error to the calculation (Treloar, 1998; Crawford, 2004; Dixit, 2015b). An IO analysis provides results for an entire industry sector, which may not be specific to a product under study if the sector has an aggregated output of different products. A statistical analysis utilizes national energy statistics to compute energy intensity of industry sectors (Treloar, 1997). A hybrid analysis

combines process or statistical method and IO-based approaches to offer a reliable and complete calculation (Rauf and Crawford, 2016; Dixit, 2017). The process or statistical data provide reliability, whereas IO data offer system boundary completeness (Lissens and Rensbergen, 1996; Stephan and Stephan, 2016). A hybrid method may have a process-based or IO-based framework (Treloar, 1998; Crawford, 2004). Depending on the framework, hybrid methods also inherit some of the reliability or completeness issues in their calculation (Dixit, 2015b). Studies consider an IO-based hybrid method to potentially offer a complete and reliable embodied energy computation (Crawford, 2004; Stephan and Stephan, 2016; Dixit et al., 2016b). In an IOH method, reliable process or statistical data are integrated into an IO model, which provides a wider system coverage (Lissens and Rensbergen, 1996; Rauf and Crawford, 2016).

Even though, an IOH method provides a complete and reasonably reliable energy calculation, it still needs improvements in its completeness, reliability, and specificity (Dixit, 2015b). IO accounts, conventionally, do not cover capital investments and human expenditures, thereby, excluding the energy embodied in capital inputs and human labour (Treloar, 1998; Crawford, 2004; Dixit, 2017). Adding labour and capital energy to IOH method can further enhance its completeness (Dixit et al., 2015). If actual energy usage of each industry sector is integrated into an IO model, the use of unreliable energy tariffs can be avoided further improving the reliability of an IOH model (Acquaye, 2010; Dixit, 2015b). The specificity of an IOH model depends on the sectoral resolution of IO accounts (Joshi, 1998; Dixit, 2017). For instance, if an industry sector produces a wide variety of products, its embodied energy intensity cannot be generalized for all of them (Joshi, 1998). However, if it manufactures a specific product, its results may be more specific to that product (Dixit, 2017). For instance, the energy intensity of an industry sector manufacturing plastic products may not be specific to a plastic product installed in a building because the sector also produces other products used in automobiles, packaging materials, toys, medical equipment, etc. A cement production sector, on the other hand, produces just cement, so its energy intensity is more specific to cement as a building material (Dixit et al., 2015).

2.2 Initial and recurrent embodied energy

Studies calculated IEE and REE of facilities using any of the four embodied energy analyses. The calculation of IEE includes both direct and indirect energy used in a facility's initial construction (Treloar, 1998; Acquaye, 2010). The process-based methods account for direct energy with reasonable completeness but provide highly incomplete coverage for indirect energy (Crawford, 2004; Acquaye, 2010; Dixit, 2015b). Studies (Crawford & Treloar, 2005; Guan et al., 2016) have shown that process-based calculations conventionally underestimate embodied energy. For instance, Crawford and Treloar (2005) found that the IOH embodied energy values were over three-times the process-based values. Similarly, Guan et al. (2016) recently found that the gap between process-based and IOH results can be up to 100%. Process-based calculations include multiplying quantities of materials used in construction by their respective embodied energy values (Crawford, 2004; Dixit, 2015b). However, materials or products for which no data is available remain excluded from the calculation (Crawford, 2004; Dixit, 2017). Other processes such as onsite administration, consultancy, and other financial services are hardly covered in a process-based calculation (Crawford, 2004; Dixit et al., 2015). Covering indirect energy beyond the upstream stage of construction material manufacturing becomes extremely difficult due to data unavailability (Treloar, 1998; Crawford, 2004; Dixit, 2017). IO-based calculations cover both direct and indirect energy and result in embodied

energy values higher than the process-based ones (Crawford & Treloar, 2005; Guan et al., 2016). A process-based hybrid analysis offers a wider coverage of energy inputs due to the inclusion of IO data and provides reliable results (Crawford, 2004). Its results, however, are less complete than the IOH methods (Crawford and Treloar, 2005).

There are two commonly used approaches to calculate REE of a facility. In the first approach, actual maintenance and replacement activities are determined using either published data such as component service life or a pre-determined percentage value. For instance, studies such as Adalberth (1997) and Bastos et al. (2014) sourced replacement cycles to compute the annual REE of study buildings, whereas studies such as Barnes and Rankin (1975) and Stephan et al. (2011) referred to a fixed percentage to compute the same. The second approach utilizes maintenance and replacement costs along with any major capital renewal to compute the annual REE (Dixit et al., 2016b). Although both the approaches contain some degree of uncertainty due to data quality issues, the second approach may provide a more complete calculation because most life cycle cost models are quite comprehensive in their coverage of maintenance, replacement, and refurbishment processes (Dixit et al., 2016b). Overall, studies (Adalberth, 1997; Pullen, 2000; Treloar et al., 2000; Leckner and Zmeureanu, 2011) suggested that the annual REE of a facility might be equivalent to approximately 1% of its IEE. However, note that this percentage assumes a generic system boundary coverage and a complete calculation may yield a much higher result if it includes all interior and exterior maintenance and replacement activities. The IEE and total REE of a facility constitute a majority of its total life cycle embodied energy (Cole and Kernan, 1996; Vukotic et al., 2010). Together, these may represent over 95% of the life cycle energy embodied in a building (Dixit et al., 2015).

2.3 Input-output-based hybrid (IOH) embodied energy calculation method

An IOH model may include hybridization of process and IO data or statistical and IO data (Rauf and Crawford, 2015; Dixit, 2017). The goal is to enhance the reliability of an IO model, which already has an improved system completeness. A number of approaches exist to integrate reliable process data into an IO model. A basic version of IOH approach integrates process data of material quantities and their respective IO-based or IOH embodied energy. Another approach proposed by Treloar (1997) systematically identifies, extracts, and replaces direct energy paths with comparable process data. A number of studies such as Crawford (2004) and Langston & Langston (2007) later utilized this approach to construct IOH models. Crawford (2004) argued that instead of just direct energy paths total energy paths must be replaced. Carter et al. (1981) proposed to integrate statistical energy data for each industry sector in an IO model to compute embodied energy without using unreliable energy prices. This method is very useful if energy data usage for industry sectors is available. Later, Dixit et al (2015) used Carter's approach to construct an improved IOH model using 2002 Benchmark IO accounts and energy use data. With each new study, the existing versions of IOH models were improved over time.

2.4 Embodied energy and facilities management

Some studies (e.g. Dixit et al., 2014 and 2016a) strongly contested the idea of involving facility managers into a design process right from the pre-design stage when an architectural program is being finalized. Two parameters affect the life cycle embodied energy. The first parameter is the choice of materials and systems, which must be durable with long service life (technical

and social service life), low-maintenance, low-embodied energy, locally available, and with a strong reuse and recycling potential (Chew, 2016). Second, to be functionally appropriate, material choices must also match the function of a space where the material is installed (Kanniyapan et al., 2015). A facility manager can also help select a right design solution, which ensures constructability and life-long maintainability (Dixit et al., 2014). A facility manager makes a majority of these choices, particularly during a long service life of a facility (Dixit et al., 2014 and 2016a). Involving a facility manager can reduce the life cycle energy and carbon footprint of a facility. Facility management also deals with building operations influencing annual operating energy use (Brown and pit, 2001; Elmualim et al., 2010). A decision to renovate or demolish is the second parameter that can significantly affect the embodied energy of built environment (Brown and pit, 2001; Elmualim et al., 2010). Facility managers conventionally control such asset management decisions, which can considerably reduce the energy and carbon footprint by avoiding new construction and renovating instead (Brown and pit, 2001; Elmualim et al., 2010; Dixit et al., 2014). In fact, studies such as Ding (2004), Langston & Langston (2007), Copiello (2016), and Dixit (2016) have supported a strong positive correlation between the life cycle cost components and embodied energy. In that sense, if a facility manager governs the life cycle cost, his/her decisions can considerably influence both life cycle embodied and operating energy.

3. RESEARCH METHODS AND OBJECTIVES

3.1 Objectives

From the literature review, a need to quantify embodied energy completely and reliably emerges. In spite of gradual improvements done to an IOH method, some issues still remain unresolved. For instance, the energy embodied in labour and capital inputs is still not covered in the current versions of IOH methods. If the IO tables are not detailed enough, there may also be a problem of the lack of specificity. Even though studies have developed improved models earlier, those models were relevant to a geographic location and time. The same model may not be representative geographically and temporally in a situation. The main goal of this study is to develop an improved IOH model to compute initial and recurring embodied energy in a reliable and complete manner. The following are the key research objectives:

- Gather actual energy use data of industry sectors of the United States' economy
- Construct an improved IOH model using the latest 2007 Benchmark IO accounts and integrate human energy inputs
- Compute, discuss, and evaluate direct and total energy intensities of construction sectors for initial construction and maintenance and replacement

3.2 Methods

This study includes a three-step method to gather energy use data (see Figure 2). First, the energy use data was collected from relevant sources, then it was disaggregated or averaged wherever required, and finally, it was converted into energy units (Btu) for analysis. The economy of the United States contains 20 major sectors represented by 2-digit NAICS codes. They provide goods and services to consumers and other industry sectors. The data on the energy consumed by these sectors to produce goods and services was available in either energy units and/or monetary values. Data such as electricity use were given in kilo Watt hour (kWh),

fuel consumption data for oil and gas, natural gas, coal and others were given in dollars and million-Btu (MBtus). Disaggregation was required for the fuel data collected in energy units for more than half of the manufacturing sector. However, data on the total fuel consumption in monetary unit across the 6-digit NAICS code industries was available. We derived disaggregation coefficients from the 2006 and 2010 Manufacturing Energy Consumption Survey (MECS) data reported by the US Department of Energy. These coefficients were used to disaggregate the aggregated fuel data collected in energy units. The labour data was available in terms of the total number of employees, the percentage of production and non-production workers and a gender ratio for male and female workers. We computed Physical Activity Level (PAL) and Basal Metabolic Rate (BMR) to calculate the food requirements (as total energy requirements) of production and non-production workers under the male and female categories. We collected energy use data from federal agencies such as the United States Census Bureau (USCB), United States Department of Energy (USDOE), United States Energy Information Administration (USEIA), and the United States Department of Agriculture (USDA). We used the process of IOH model development as proposed by Dixit et al. (2015).

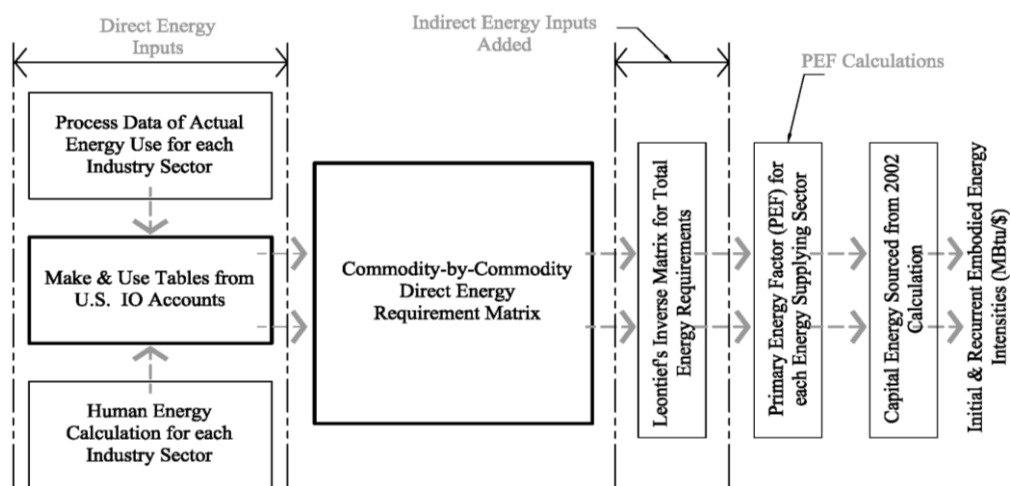

Figure 2: Research Methodology

We sourced and used the make and use tables published under the 2007 United States Benchmark Input-Output Accounts by the Bureau of Economic Analysis (BEA), United States Department of Commerce (USDOC). We integrated actual energy use data into the use table. Adjustments were made to the make and use tables to integrate energy use in the categories of electricity, coal, natural gas, petroleum, and human energy. A hypothetical commodity of labour energy was added to the make and use table to represent human energy. Using the make and use tables, we constructed an IO-model using Microsoft Excel and MATLAB to compute direct and total energy requirements. Direct requirements indicate the amount of inputs required by an industry sector to produce one-dollar worth of its output. The total requirements also take into account the indirect requirements as illustrated in Figure 1. The total requirements were calculated by deriving Leontief's inverse matrix. Figure 2 schematically illustrates the overall process of developing the improved IOH model. We used the hybrid approach proposed by Carter et al. (1981), which circumvents the use of unreliable energy prices. To avoid energy double-counting error, all energy and non-energy inputs to energy supplying sectors were kept at zero. We used primary energy factors (PEFs) computed by Dixit et al. (2014b) to cover these excluded inputs. A detailed description of an IOH model development process can be referred from Dixit et al. (2015).

4. FINDINGS

4.1 Embodied energy intensities

Table 1 lists the calculated embodied energy intensities of various construction sectors. The *Other residential buildings* sector's IEE intensity is the highest among all sectors. The REE intensity of residential maintenance and repair activities is higher than other non-residential buildings. Among non-residential facilities, the IEE intensity of healthcare facilities dominates the other building types. Figure 3 shows the breakdown of the total embodied energy intensities for each energy source type. The multi-family residential buildings' construction is more electricity-intensive than other residential buildings. Among commercial buildings, healthcare facilities consume the maximum electricity in their construction. Surprisingly, petroleum use dominated the seven out of the nine sectors with non-residential maintenance and repair consuming the most. The human energy embodied in labour ranged between 1.8% and 5% indicating the significance of assessing and optimizing labour use.

Table 1: Calculated embodied energy intensities for construction sectors

Construction Sector	Embodied Energy Intensity (MJ/\$)
Nonresidential maintenance and repair	8.74
Residential maintenance and repair	10.17
Health care structures	10.31
Educational and vocational structures	9.73
Commercial structures, including farm structures	7.19
Other nonresidential structures	7.80
Single-family residential structures	8.29
Multifamily residential structures	9.86
Other residential structures	10.96

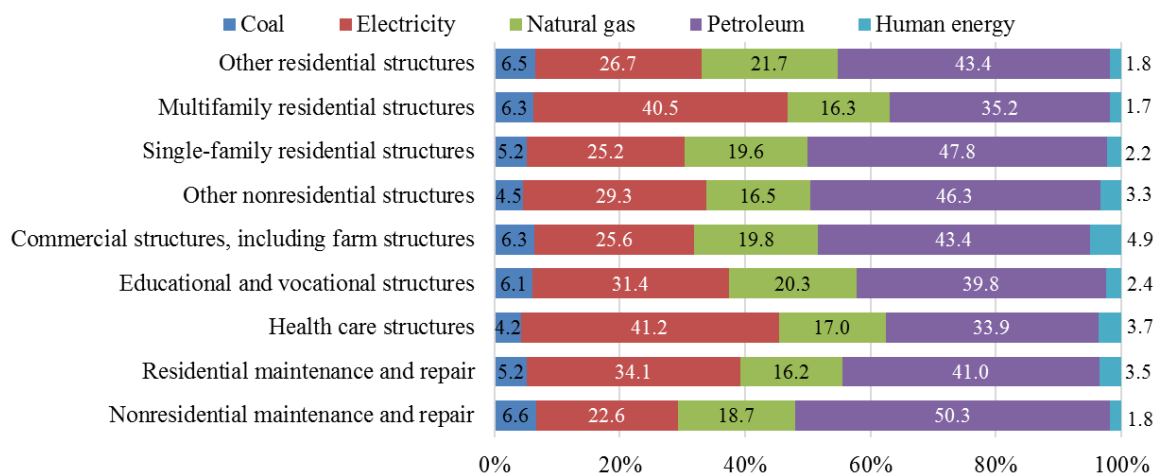

Figure 3: Breakdown of embodied energy intensities by energy source type

Figure 4 shows the direct and indirect energy components of the total embodied energy. The direct energy denotes the energy used directly in onsite and offsite construction, transportation, administration, and consulting processes, whereas the indirect energy covers building materials, products, and equipment installed in the building. In most sectors, the share of indirect energy is more than 70% signifying the importance of completely accounting for all indirect energy inputs. On average, residential and commercial construction sectors consume

over 26% and 28% direct energy, respectively. The direct energy usage for the maintenance and repair activities is approximately 30%.

4.2 Embodied energy: initial and recurrent

Table 2 lists the initial and recurrent embodied energy of single and multi-family residential structures. It also reports IEE and annual REE of healthcare and educational facilities. We sourced the initial construction cost and maintenance, replacement, and renovation cost data from standard cost guides (Taylor, 2011; Whitestone Research, 2008) to convert embodied energy intensities to embodied energy. Column 4 and 5 report the initial embodied carbon (IEC) and recurrent embodied carbon (REC), respectively resulting from embodied energy usage. The carbon intensities of fuels are sourced from EIA (2016).

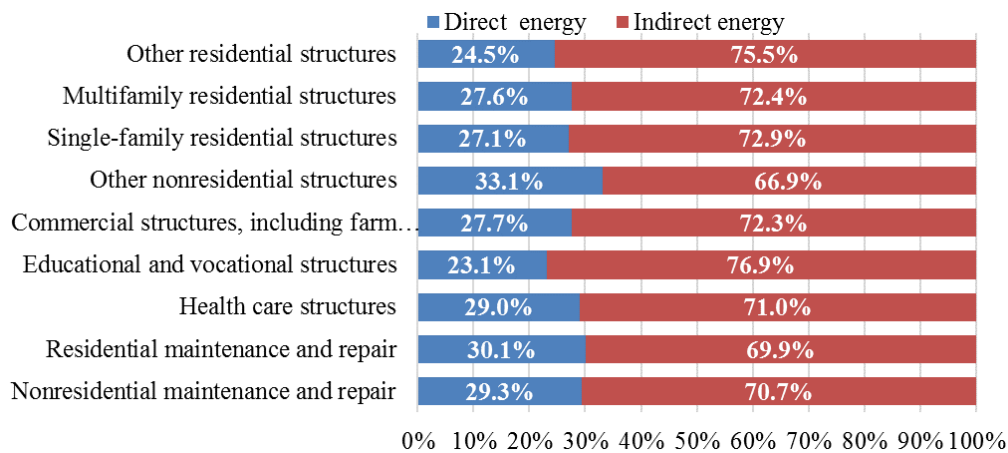

Figure 4: Direct and indirect energy components

Table 2: Calculated embodied energy and carbon for building types

Building Type	IEE (GJ/m ²)	REE (GJ/m ²)	IEC (kg/m ²)	REC (kg/m ²)
Single-family house	12.0	0.3	220	1
Multi-family house	21.7	9.7	404	20
Health care construction	42.6	5.3	785	9
Educational construction	21.6	3.4	397	6

Note that the embodied energy is calculated using the embodied energy intensities (MJ/\$) and construction, maintenance, and replacement cost data. Hence, the cost of construction and maintenance will govern the amount of IEE and REE of a facility (GJ/m²). A higher embodied energy intensity of healthcare facilities is expected, particularly looking at the number and type of building systems installed in them. Because multi-family maintenance and repair is aggregated with residential maintenance and repair sector, its energy intensity is quite high. A higher proportion of indirect energy component is due to the use of energy-intensive materials, assemblies, and products in building construction. The calculated values of embodied energy are also compared with the ones reported in literature. Column 1 of Table 3 lists IOH-based embodied energy values reported in literature for residential facilities, which range between 10.2 and 17 GJ/m². Although literature values belong to studies from different locations and time, the values calculated in this study fall under the same range. None of the referred residential case studies included a multi-family case study. A higher IEE value for multi-family

units computed by this study might be due to a wider system boundary coverage that also includes built spaces between apartment blocks. The IOH-based IEE values of commercial facilities reported in literature range between 8.8 and 29.4 GJ/m². We could not compare the embodied energy of hospital facilities because, like multi-family residential units, none of the commercial studies evaluated a healthcare facility. However, the value of IEE of an educational building is comparable to the ones reported in the literature. The annual REE computed in this study represents a lower value of 0.3% of IEE for single-family buildings to a higher value of 5% of IEE for a multi-family facility. The annual REE of commercial facilities is equivalent to 1.2-1.5% of their IEE. The calculated annual REE values are in alignment with the ones reported by Adalberth (1997), Pullen (2000), Humphrey (2004), and Langston (2006) (1% - 3% of IEE).

Table 3: Calculated values compared with published values

Residential Case Studies	IEE(GJ/m²)	Commercial Case Studies	IEE(GJ/m²)
Fay & Treloar, 1998	13.8	Treloar, 1993	8.77
Fay et al., 2000	14.1	Crawford & Treloar, 2003	16.8
Crawford et al., 2002	16.3	Crawford & Treloar, 2003	16.4
Treloar et al., 2003	12.11	Crawford & Treloar, 2005	25.8
Crawford & Treloar, 2003	10.2	Langston, 2006	21.76
Crawford, 2008	17	Crawford, 2008	29.4
Rauf et al., 2012	13.4	Crawford, 2008	25.8
Rauf & Crawford, 2015	13.4	Shen, 2010	11.1
This study	12.0	This study	42.6
This study	21.7	This study	21.6

5. CONCLUSIONS

In this study, we developed an improved IOH model to compute the embodied energy intensity of various construction sectors. Note that we used 2007 Benchmark Input-output Accounts, which contain disaggregated construction sectors. This is an improvement over earlier IO accounts because this ensures the specificity of results. Additionally, we avoided using unreliable energy prices multiple times to enhance the reliability of the IOH model. The results of the IOH model, therefore, can be considered relatively complete and reliable. Even after these improvements, an IO-based framework still needs a finer sectoral resolution, which can address the aggregation problem and may also resolve partially the issues arising from the proportionality and homogeneity assumptions. In this study, we demonstrated the calculation of IEE and REE, the two largest components of a facility's life cycle embodied energy, which can be optimized by informed FM decision-making. Literature has emphasized the significance of material and design alternative selection during the design phase, which must be done in consultation with a facility manager. Due to their extensive involvement in life cycle management, facility managers can also affect the REE of a building. In fact, optimizing IEE and REE involves mutual trade-offs, which a facility manager could know better. Optimizing life cycle embodied energy may also influence a facility's operating energy, which can be better judged by facility managers. As discussed by Dixit et al. (2016b), with over 81 billion-square foot of commercial floor space, the impact of FM decisions on initial as well as recurrent embodied energy and carbon can be enormous, which further supports including facility managers in design decisions.

6. REFERENCES

- Acquaye, A., 2010. A stochastic hybrid embodied energy and CO₂ eq intensity analysis of building and construction processes in Ireland, Ph.D. Thesis, Dublin Institute of Technology, Dublin, 2010.
- Adalberth, K., 1997. Energy use during the life cycle of single-unit dwellings: examples, *Building and Environment*, 32(4), pp.321-329.
- Barnes, D., & Rankin, L., 1975. The energy economics of building construction. *Building International*, 8, pp.31-42.
- Bastos, J., Batterman, S. A., & Freire, F., 2014. Life-cycle energy and greenhouse gas analysis of three building types in a residential area in Lisbon. *Energy and buildings*, 69, pp.344-353.
- Baum, M., 2007. Green building research funding: an assessment of current activity in the United States, Washington, DC: US Green Building Council.
- Brown, A.W., & Pitt, M.R., 2001. Measuring the facilities management influence in delivering sustainable airport development and expansion, *Facilities*, 19(5/6), pp.222-232.
- Carter, A.J., Peet, N.J., & Baines, J.T., 1981. Direct and indirect energy requirements of the New Zealand economy. New Zealand Energy Research and Development Committee, New Zealand.
- Chew, M. Y. L., Conejos, S., & Asmone, A. S., 2017. Developing a research framework for the green maintainability of buildings, *Facilities*, 35(1/2).
- Cleveland, C.J., & Costanza, R., 2008. Net energy analysis. Encyclopedia of Earth. Retrieved on March 13, 2010 from http://www.eoearth.org/article/Net_energy_analysis
- Cole, R.J., & Kernan, P.C., 1996. Life-cycle energy use in office buildings, *Building and Environment*, 31(4), pp.307-317.
- Copiello, S., 2016. Economic implications of the energy issue: Evidence for a positive non-linear relation between embodied energy and construction cost, *Energy and Buildings*, 123, pp.59-70.
- Crawford, R.H., 2008. Validation of a hybrid life-cycle inventory analysis method. *Journal of environmental management*, 88(3), pp.496-506.
- Crawford, R.H., 2004. Using input-output data in life cycle inventory analysis," Ph.D. Thesis, Deakin University, Victoria, Australia, 2004.
- Crawford, R., Fuller, R., Treloar, G.J. and Ilozor, B.D., 2002. Embodied energy analysis of the refurbishment of a small detached building. In *proceedings of the 36th conference of the Australian and New Zealand Architectural Science Association, Geelong, November, 2002.* (pp. 93-100).
- Crawford, R.H. and Treloar, G.J., 2003, January. Validation of the use of Australian input-output data for building embodied energy simulation. In *IBPSA 2003* (pp. 235-242).
- Crawford, R., & Treloar, G., 2005. An assessment of the energy and water embodied in commercial building construction. In Australian Life Cycle Assessment Conference (4th: 2005: Novotel, Sydney, NSW) (pp. 1-10). Australian Life Cycle Assessment Society.
- Ding, G.K.C., 2007. Life cycle energy assessment of Australian secondary schools, *Building Research and Information*, 35(5), pp.487-500.
- Dixit, M.K., 2016b. An Input-Output-based Hybrid Recurrent Embodied Energy Calculation Model for Commercial Facilities, In Proceedings of 2016 World Building Congress, Tampere, Finland.
- Dixit, M. K., 2015. A Framework for an Improved Input-output-based Hybrid Method for Embodied Energy Calculation. In Proc. 51st ASC Annual International Conference hosted by Texas A&M University in College Station, Texas.
- Dixit, M. K., 2016. Embodied energy and cost of building materials: correlation analysis, *Building Research & Information*, pp.1-16.
- Dixit, M. K., 2017. Embodied energy analysis of building materials: An improved IO-based hybrid method using sectoral disaggregation, *Energy*, 124, pp.46-58.
- Dixit, M. K., Culp, C. H., Fernandez-Solis, J.L. & Lavy, S., 2016b. Reducing carbon footprint of facilities using a facility management approach, *Facilities*, 34(3/4), pp.247-259.
- Dixit, M. K., Culp, C. H., & Fernandez-Solis, J. L., 2015, Embodied Energy of Construction Materials: Integrating Human and Capital Energy into an IO-Based Hybrid Model, *Environmental science & technology*, 49(3), pp.1936-1945.
- Dixit, M.K., H. Culp, C., Lavy, S., & Fernandez-Solis, J., 2014. Recurrent embodied energy and its relationship with service life and life cycle energy: a review paper, *Facilities*, 32(3/4), pp.160-181.
- Dixit, M.K., Culp, C. H., and Fernández-Solís, J. L., 2013. System boundary for embodied energy in buildings: A conceptual model for definition, *Renewable and Sustainable Energy Reviews*, 21, pp.153-164.
- Dixit, M.K., Culp, C.H. and Fernandez-Solis, J.L., 2014. Calculating primary energy and carbon emission factors for the United States' energy sectors. *RSC Advances*, 4(97), pp.54200-54216.
- EIA, 2016. Carbon Dioxide Emissions Factors. Retrieved from https://www.eia.gov/environment/emissions/co2_vol_mass.cfm

- Elmualim, A., Shockley, D., Valle, R., Ludlow, G., & Shah, S., 2000. Barriers and commitment of facilities management profession to the sustainability agenda, *Building and Environment*, 45(1), pp.58-64.
- Fay, M.R. & Treloar, G., 1998. Life cycle energy analysis-a measure of the environmental impact of buildings. *BEDP Environment Design Guide*, (November), pp.1-7.
- Fay, R., Treloar, G. and Iyer-Raniga, U., 2000. Life-cycle energy analysis of buildings: a case study. *Building Research & Information*, 28(1), pp.31-41.
- Guan, J., Zhang, Z., & Chu, C., 2016. Quantification of building embodied energy in China using an input-output-based hybrid LCA model, *Energy and Buildings*, 110, pp.443-452.
- Humphrey, S., Amato, A. and Frewer, R., 2012. Whole life comparison of high rise residential blocks in Hong Kong.
- IFMA, 2010. Operations and maintenance benchmarks for health care facilities,” International Facility Management Association, Houston, USA.
- Joshi, S.V., 1998. Comprehensive product life-cycle analysis using input output techniques. Ph.D. Thesis, Carnegie Mellon University, Pittsburgh, PA, USA.
- Kanniyapan, G., Mohammad, I. S., Nesan, L. J., Mohammed, A. H., & Ganisen, S., 2015. Façade Material Selection Criteria for Optimising Building Maintainability, *Jurnal Teknologi (Sciences & Engineering)*, 75(10), pp.17-25.
- Langston, Y.L., 2006. Embodied energy modeling of individual buildings in Melbourne, the inherent energy-cost relationship, Ph.D. Thesis, Deakin University, Australia.
- Langston, Y.L., & Langston, C.A., 2007. Building energy and cost performance: An analysis of 30 Melbourne Case Studies, *Australian Journal of Construction Economics and Buildings*, 7(1), pp.1-18.
- Leckner, M., & Zmeureanu, R., 2011. Life cycle cost and energy analysis of a Net Zero Energy House with solar combisystem, *Applied Energy*, 88(1), pp.232-241.
- Lissens, G., & Rensbergen, J. V., 1996. BIOSCOPE: A model combining Markov-chain theory and input-output table data to estimate the CO2 content of final demand, *Environmetrics*, 7(1), pp.97-107.
- Monahan, J., & Powell, J. C., 2011. An embodied carbon and energy analysis of modern methods of construction in housing: A case study using a lifecycle assessment framework, *Energy and Buildings*, 43(1), pp.179-188.
- Nässén, J., Holmberg, J., Wadeskog, A., & Nyman, M., 2007. Direct and indirect energy use and carbon emissions in the production phase of buildings: an input-output analysis, *Energy*, 32(9), pp.1593-1602.
- Pullen, S., 2000. Energy assessment of institutional buildings, In Proceedings of ANZAScA, 1-3 December 2000, University of Adelaide, Adelaide, Australia.
- Rauf, A. and Crawford, R.H., 2012. The effect of material service life on the life cycle energy of residential buildings. In *ASA2012 Gold Coast: Department of Architecture*, Griffith University.
- Rauf, A., & Crawford, R. H., 2015. Building service life and its effect on the life cycle embodied energy of buildings, *Energy*, 79, pp.140-148.
- Ristimäki, M., Säynäjoki, A., Heinonen, J., & Junnila, S., 2013. Combining life cycle costing and life cycle assessment for an analysis of a new residential district energy system design, *Energy*, 63, pp.168-179.
- Shen, S., Vale, R. and Vale, B., 2010. The life-cycle environmental impact of exhibition buildings: a case study. *Melbourne 2010 Knowledge Cities World Summit*, pp.16-19.
- Stephan, A., Crawford, R. H., & De Myttenaere, K., 2011. Towards a more holistic approach to reducing the energy demand of dwellings, *Procedia engineering*, 21, pp.1033-1041.
- Stephan, A., & Stephan, L., 2016. Life cycle energy and cost analysis of embodied, operational and user-transport energy reduction measures for residential buildings, *Applied Energy*, 161, pp.445-464.
- Taylor, H., 2011. New Construction Cost Breakdown, Special Study for HousingEconomics.com
- Thomas, A., Menassa, C. C., & Kamat, V. R., 2016. System Dynamics Framework to Study the Effect of Material Performance on a Building's Lifecycle Energy Requirements, *Journal of Computing in Civil Engineering*, 30(6), 04016034.
- Treloar, G., Fay, R., Love, P. E. D., & Iyer-Raniga, U., 2000. Analysing the life-cycle energy of an Australian residential building and its householders, *Building Research & Information*, 28(3), pp.184-195.
- Treloar, G.J., 1998. A comprehensive embodied energy analysis framework, Ph.D. Thesis. Deakin University, Australia.
- Treloar, G.J., 1993. Embodied energy analysis of buildings Part 2: A case study, *Exedra*, 4(1), pp.11-13.
- Treloar, G.J., Gupta, H., Love, P.E. and Nguyen, B., 2003. An analysis of factors influencing waste minimisation and use of recycled materials for the construction of residential buildings. *Management of Environmental Quality: An International Journal*, 14(1), pp.134-145.
- Vukotic, L., Fenner, R.A., & Symons, K., 2010. Assessing embodied energy of building structural elements, *Engineering Sustainability*, 163(ES3), pp.147-158.
- Whitestone Research, 2009. The Whitestone facility maintenance and repair cost reference 2009-2010, Whitestone Research Corporation, www.whitstoneresearch.com.

FACILITIES MANAGEMENT OF NHS WALES – STANDARDISATION AND OTHER IMPLICATIONS

P. L. Evans¹; T. J. Francis^{*2}; T. E. Butt²; P. Paul³

¹Facilities Department, Hywel Dda University Health Board, Carmarthen, Carmarthenshire, SA31 2AF, UK.

^{*2}School of Architecture, Built & Natural Environments (SABNE); Faculty of Architecture, computing and engineering (FACE) University of Wales Trinity Saint David (UWTSD); Mount Pleasant Campus, Swansea, SAI 6ED, UK.

³School of Architecture, Computing and Engineering; University of East London (UEL); Docklands Campus; University Way; London, E16 2RD, UK

Email: trevor.francis@uwtsd.ac.uk

Abstract: Like in the rest of the UK, the National Health Service (NHS) in Wales is one of the most crucial government departments that offers services to support the health and wellbeing of the population. Among various Facilities Management (FM) systems and processes of NHS Wales, the food production for patients, from the start to the end, is specifically selected to conduct the research, as food supply for patients is crucial. The study quantitatively establishes vast differences in costs to produce patient meals per head across NHS Wales. A questionnaire approach is applied to the top FM managers across NHS hospitals, covering not only food production itself but also other relevant FM aspects including perceptions, functions and collaborations. The findings of this study demonstrate that the adoption of a standardised, systematic and integrated protocol (such as ISO 41000), would assist in the reduction of the identified vast cost variations of food production and other associated FM aspects, thereby yielding financial gain and supporting decision-making regarding budgets. In addition, the study can well inform the Welsh Government who funds the NHS, particularly in the face of current challenging economic climate. This can also be expanded to the rest of the UK and probably abroad.

Keywords: Decision-making Facilities Management (FM); Facility Management; NHS (National Health Service); Standardisation; ISO 41000

1 INTRODUCTION

1.1 Background

For any organisation, there must be a continual commitment to combat the rate of fluctuation attributed to operating cost, time and quality of the products and/or services they deliver. These three components are the fundamental ingredients of an organisation's management, which if not correctly integrated, will affect the degree of organisational success or even the failure. The less the fluctuations occur or the more control is placed upon these three factors, the more successful the management systems and processes are likely to perform. Subsequently, this will lead to enhancing the organisation's efficiency and resulting in continual customer satisfaction. This is possible, only if appropriate levels of standardisation are embedded within the overall management system and process. In addition, perception of the personnel about overall management of an organisation and particularly facilities (FM) as a function within the organisation can influence the degree of success, or even that of failure of the organisation.

One simple example where consistent standardisation, cost and quality is evident throughout the entire management setting is that of the one of food chain giants, McDonald's. To put this example into an extremely simplified context, the cost of a "Big Mac" purchased in Birmingham is exactly the same as that of if it were purchased at a McDonald's outlet in

Swansea or anywhere in the country. In addition to this are the individual sequences involved in the production process of making the product. The resulting factor is that the quality of the final product received by the end customer is exactly the same every time or with extremely minimal variance well within the acceptable tolerance set by the management setting. This is clearly down to the high degree of standardisation in McDonald's overall management systems and processes including those of FM. The standardisation of cost, time and quality of food throughout the entire organisation has been leading to successful customer satisfaction. Given this scenario, is it not feasible that some of the FM processes currently supporting the National Health Services (NHS) can also be delivered adopting the same concept as that of McDonalds? Putting aside for now the obvious correlations between fast food chains and the increasing obesity levels in society, which ultimately is placing huge pressures on the NHS, one must not overlook the potential benefits of the efficiency that standardised companies like this can offer public sector organisations.

1.2 NHS Wales

In 2009 NHS Wales was subject to significant reconfiguration and streamlining with an emphasis on providing better care closer to home giving people more flexibility with greater independence. This reformation resulted in a reduction of 22 Local Health Boards and 7 NHS Trusts to 7 Local Health Boards and 3 NHS Trusts, respectively, where the 3 Trusts continue to providing specialist services such as Ambulance and Cancer Services. These combined operating boards now constitute as NHS Wales in its present form. Figure 1 below contextualises the scale of NHS Wales by its physical geographical boundaries.



Figure 1: Map of NHS Wales (NHS Wales, 2017)

NHS Wales has a vast amount of building stock, which equates to more than 1.8 million m² of occupied floor area covering over 704 hectares of land (EFPMS, 2014-15). Premises types and styles vary extensively, from large specialist acute hospitals providing state of the art health care to smaller local community sites offering dental and chiropody services. This expanse of building stock coupled with over 72 thousand directly employed staff clearly makes this a diverse and complex operation to manage. (Statistics Wales, 2017). This diversity and complexity requires the use of buildings, services and the integration of people to operate in the most efficient and cost effective manner, that has a productive overall management including FM with standardised systems and processes.

The actual perception and practice of FM differs hugely within the NHS Wales from the overall organisational to departmental and individual NHS sites e.g. hospitals. Some Health Boards offer an FM service encompassing all operational disciplines, without distinguishing between Hard FM (e.g. maintenance of engineering items and the building fabric, etc.) and Soft FM (such as food services and cleaning, etc.). Whereas other Health Boards manage Hard and Soft FM disciplines as two distinctly separate departmental functions. There is no agreed approach or best practice structure across NHS Wales.

Figure 2 below further contextualises the components of NHS Wales in a simplistic hierarchical diagram. The purpose of the Figure is to map the correlations between the Health Boards, and subsequent links to other NHS governing organisations such as NHS Wales Shared Services Partnership and Welsh Assembly Government. The Figure also shows the linkage between the Hospitals within each Health Board and the various branches of their FM services and processes. The dotted lines surrounding the model suggests the position at which FM standardisation and ISO 41000 implementation should be considered.

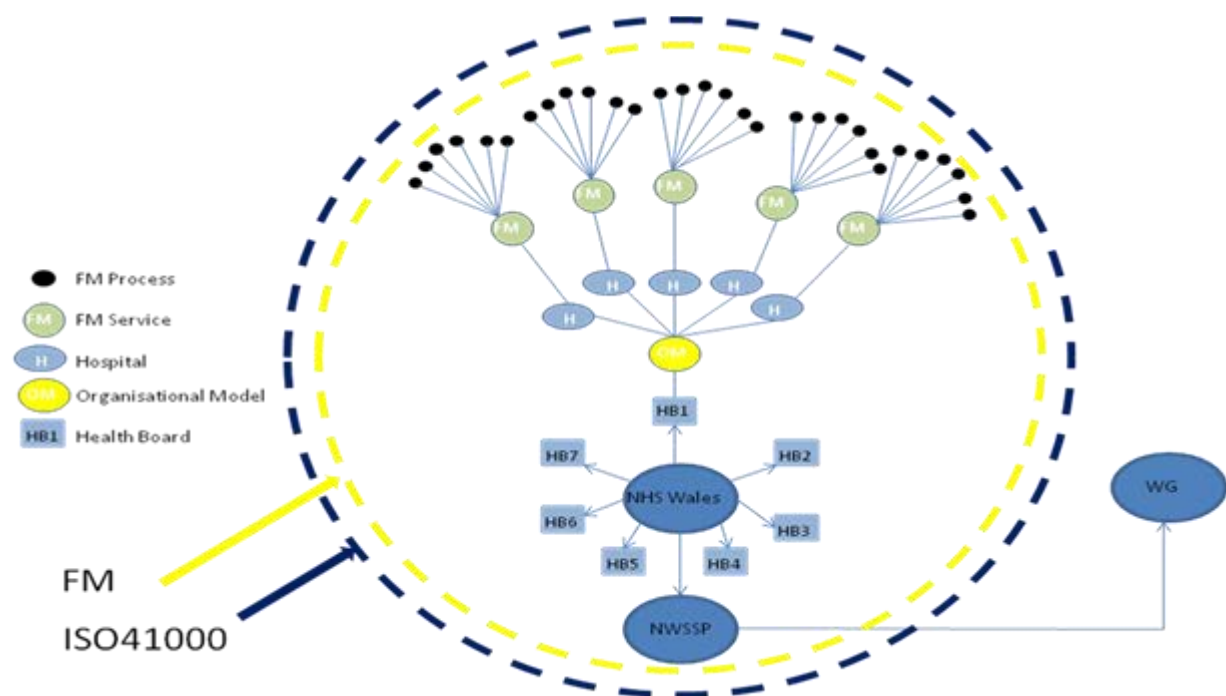

Figure 2: NHS Wales Hierarchy Diagram

FM systems and processes at each of the hospital sites vary considerably. In particular and not in isolation are the distinct variations in food production and associated services even within

individual Health Boards. Therefore, there is severe cost fluctuations across the whole of NHS Wales. In order to visualise this fluctuation, a graph has been produced (Figure 3) from the published EFPMS facts and figures. The graph depicts the cost per patient meal for each hospital in Wales. The ‘amplitude’ of the cost variation exists between the two extremes i.e. lowest being £2.22 and the highest being £13.83 per patient meal, with an average cost of £3.29. This strongly suggests that there is no standardisation of FM systems and processes within NHS Wales.

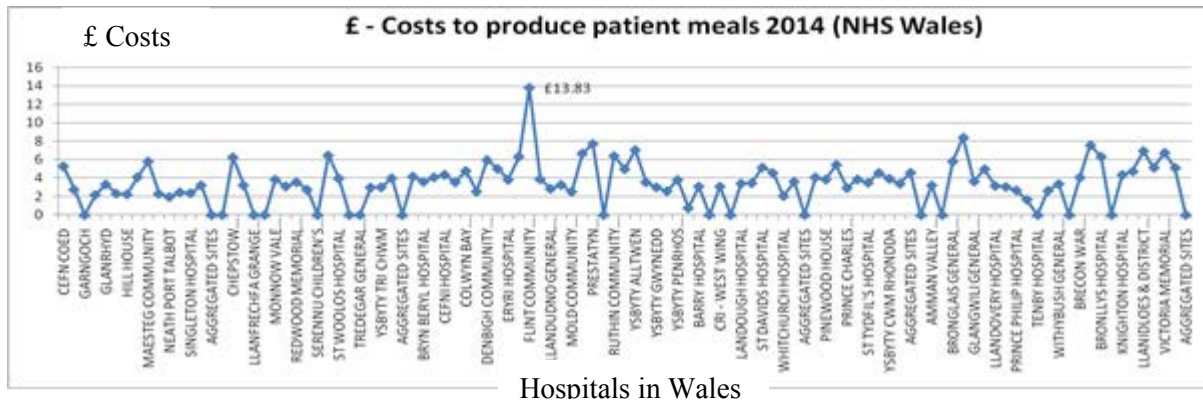

Figure 3: Production costs per patient meal in NHS Wales for 2014 (derived from data from NHS Wales Specialist Services Partnership EFPMS 2013/2014 Estates Data)

2 AIMS AND OBJECTIVES

This research specifically focuses on the 7 NHS Health Boards in Wales as outlined in Figure 1, and excludes the 3 Trusts. Furthermore, this is essentially an empirical study based on work experiences of senior NHS staff that have been working in FM for a significant length of NHS experience and service. This paper does not consider the views and experiences from the end customer or the receiver's perspective of the FM services. However, given the opportunity for further research, the comparison between the two groups i.e. FM managers and FM output receivers – can prove effectively useful to enhance the benchmarking.

The overall aim of this study is to highlight the scale of perception variation of FM with in NHS Wales. This also includes establishing whether the implementation of a standardised protocol, such as ISO 41000 which is currently under development, would assist to provide standardisation of FM systems and processes. Thereby, help to reduce costs and improve efficiency of the Health Boards in Wales in a range of FM functions including that of the food production and service. To achieve this aim, the following key objectives are executed:

1. Examine the strategic position of NHS Wales and identify current problems regarding FM (systems and processes) based on dynamics of variation among the Health Boards.
2. Accordingly, specify various themes to use as building blocks in designing a structured questionnaire.
3. Employ the questionnaire, capture FM perceptions – Collate viewpoints from FM leaders across each of the Health Boards in Wales. One example is to assess the potential success that ISO 41000 can bring to NHS Wales in view of perceived benefits regarding implementation of other similar international management standards (e.g. ISO 9001 and ISO 14001).

4. Deploy food production and service as a vehicle to conduct research, explore the existing FM mechanisms around food production arrangements within the Welsh Health Boards, and outline possible directives for change and standardisation.

3 FACILITIES MANAGEMENT (FM)

3.1 FM in general

There are many and yet different definitions of FM. One FM definition is particularly provided by the British Institute of Facilities Management (BIFM) which has also formally been adopted by the European Committee for Standardisation (CEN – French acronym). This definition is as follows: “Facilities management is the integration of processes within an organisation to maintain and develop the agreed services which support and improve the effectiveness of its primary activities”. In other words, FM can also be defined like this: In its simplest form, the integration of the physical environment incorporating people, staff and operational services is referred to as the practice of FM.

The practice and principle of FM as a discipline has been around for decades. Its journey has evolved extensively in varying forms, styles and relied upon differently by the environments in which it is applied. FM of today is a very powerful strategic business tool, which if deployed correctly and given the status it requires can offer significant competitive advantages. FM is capable of contributing towards success of an organisation if it is given the opportunity to exploit new ideas and perform innovative activities that are regularly measured and integrated within the overall business goals of the organisation. (Nazali and Pitt, 2009).

3.2 FM and NHS

The NHS is a vast business operation combining numerous activities, all working simultaneously and continuously interacting with one another. The overall aim of this interaction is to provide an NHS service which is most importantly safe, effective, and efficient, and continually remains within its financial limitations to support the delivery of the patient care. FM is therefore unquestionably a fundamental function that helps to support these numerous activities individually and in varying combinations. It is essentially the glue that keeps the various services functioning and operational. It therefore can exist in a variety of forms, from making sure that premises are equipped with electricity for power 24 hours a day 365 days a year, to making sure that buildings are lit and heated properly. Also making sure that they are cleaned while sufficient food and water are available, and that the mail gets regularly and promptly delivered to the appropriate person / staff. Activities like these may appear trivial to many, but to the few they are critical components.

However, this research demonstrates that the actual perception and practice of FM differs across the Welsh NHS significantly. This paper shows that even between the individual Health Boards who participated in the research there were distinct differences on the components that made up the FM agenda, and furthermore vast differences were apparent at individual departmental levels within each Health Board. The notion of standardisation to achieve greater efficiency is therefore worthy of further exploration in the context of FM, especially when significant variations in FM delivery costs are noticeable within just a small quantity of EFPMS data.

The vast amount of expenditure being spent on public services such as the NHS is significant and is continually being debated and criticised in the media. Questions are regularly featured on how budgets are being allocated and spent on public services. The issue of improved efficiency is further argued by (Alexander, 2003) where “Greater accountability for the use of public money” needs to be justified. To extend on this, recently featured discussions on potential back office mergers have taken place between two key public services such as the Fire Brigade and the Police Force in England. Although this has raised some key concerns by each party on its complexity and feasibility, the fundamental driver for this is efficiency, costs and reduction in duplication of services (BBC News, 2016).

The scale of NHS spending growth published in a statement from the Institute for Fiscal studies in July 2012, reveals that “public spending on the UK NHS has increased faster than economy-wide inflation since 1950’s, with an average annual growth rate of 4%”. To put this into context the 2012 NHS budget was a reported £135 billion pounds, compared to the defence budget at £45 billion pounds. Proportionally, the average percentage of budget allocated to Health Boards for FM services in totality varies between 4% and 6%; however, there is no formal published evidence on this. Given the variances already known and the potential benefits of standardisation that are being argued, even an optimistic 0.5% cost reduction, arising from improved efficiency in FM services could equate to potential savings of around £40m per annum. Comparing these efficiency savings against real time resources, equates to an additional 10 doctors and 100 nurses for the frontline NHS services. Although it is acknowledged that this is somewhat hypothetical and does not consider implementation costs and time of implementation. The significance and scale of the outcome is potentially enormous.

4 RESEARCH STRATEGY

4.1 Questionnaire development

A web based questionnaire is created using an online facility called e-survey creator and intentionally combined an array of key questioning of FM services. One of the core aims of this research has been to assess if the introduction of ISO 41000 would prove effective for FM for NHS Wales. It is, however, considered essential that other elements of FM are introduced in the survey, even though the key focus of the research is standardisation. A wide range of 63 questions included in the questionnaire are specifically developed to capture varying perceptions along different FM aspects. Furthermore, participants are specifically asked to express their thoughts and opinions on the concept of introducing a standardisation protocol for all FM services within Wales and whether or not this would offer benefits or conversely disadvantages.

The questionnaire is systematically structured into sections and sub-sections with carefully, appropriately worded questions. This is in order to ease the participant through the questionnaire completion process and to limit the potential for non-returns or responses that are not considered with appropriate prior thoughts and judgement. The questionnaire contains questions with a variety of styles, which includes the likert scale, yes and no closed questions, and open-ended questions, thereby enable the respondent to explain their response more effectively. Some questions are listed below as examples:

- Do you feel that FM is a core or non-core function within your organisation?

- How often does your organisation collaborate or share experiences with other neighbouring health boards?
- Please specify what type of FM management structure your organisation currently operates.
- Are you aware of the pending development of ISO41000 for FM?
- Would the implementation of ISO41000 would lead to improved efficiency?

4.2 Target group identification

A distribution strategy for the questionnaire circulation is agreed with the FM lead/directors (person holding the most senior FM position in the organisation) at each of the participating health boards in Wales. These FM leads are the target group and formally invited to take part as primary participants of the survey. Each participant is issued with a secure web-based questionnaire directly from the e-survey creator system. The reason for targeting the FM lead is intentional as due to the high hierarchical position they hold within the organisation, they are likely to offer the most accurate and informed response in both contexts – FM strategy and FM operation(s).

4.3 Questions selection

From the perspective of the scope of this paper, a specific portion of data is gathered from the completed questionnaires to collate relevant key results and findings. Although the total research (not reported in this paper due to brevity) includes all the 63 questions and corresponding results, but for the amount of the research being reported in this paper, only 23 of out of the total 63 questions are considered to be of critically relevant value. Therefore, the analysis in this paper is based on 23 questions only which are individually extracted from the entire list of 63 questions from each completed questionnaire. The original total questionnaire also includes aspects such as the use of the information technology in FM and staff morale. Although these are also extremely interesting and useful areas, they, however, fall outside the main objectives of this research and can be potentially included in future publications. Some examples out of the 23 questions are listed above.

5 RESULTS, ANALYSES AND DISCUSSIONS

5.1 FM perception variation

The data on this aspect of the research clearly reveals that each of the participating Health Boards have their own distinct opinion on what FM is and what its core aim is within their individual board. It can be safely stated that they are simply looking after their own agenda. This is evident across a variety of responses. The responses are found to be substantially different and although the primary focus as expressed in the responses, is ensuring the patient care, the variance in FM delivery, however, is particularly clear as explained further in Section 5.3.

5.2 FM model/strategy variation

The variation in the FM model or strategy is also obvious in the completed questionnaire. It could be argued that the perception variation has been playing a role in causing the variation in FM model or strategy from one Health Board to another. One of the key aspects of this research is to seek a common platform or a standardised model, from which FM can be practised for all Health Boards, rather than having such a variation. Consequently, if the perception findings were opposite to what is discovered it could be argued that the model variation would have potentially been much more structured and uniform across Wales or maybe less variations.

Moreover, there is no clearly set direction or pathway for developing FM to cope with future demands and pressures. The respondents' data has revealed that there is a lack of consideration on the strategic direction of FM across Wales, with only 50% of respondents confirming to have developed an FM strategy for their individual Health Board and also that they are aware of their FM strategy. Therefore, further research is required with the other 50% Health Boards that what factors have been preventing them from fully developing and then disseminating their FM strategies within their respective Health Board.

5.3 FM delivery variation

This research empirically establishes some fundamental issues on how FM is being delivered and practised across NHS Wales. What is evident and more pronounced than the overall Organisation model is the fluctuation in FM delivery or processes among the Health Boards. This is more clearly revealed during the analysis of food production processes across each Health Board in Wales and also discovered during discussions with various FM staff. This is just one particular aspect of FM delivery and the variation across other parts of FM are known to be extreme, resulting in significant fragmentation across the Welsh NHS. Furthermore, this is not only limited to NHS Wales, but also beyond i.e. in the rest of the UK and other countries.

5.4 ISO 41000 implementation and FM standardisation –NHS Wales

The research actively considers if there are potential benefits in the introduction and implementation of ISO 41000 to standardise FM systems and processes across NHS Wales. The finding on this aspect is a favourable response rate agreeing that it would offer clear benefits, such as improved efficiency and allow FM performance to be measured more accurately. In contrast, the response from respondents on the success rate of other ISO implementations within their own Health Boards is much less convincing. Therefore this in some way acknowledges that there is a need for change and the need to standardise FM.

The introduction of ISO 41000 into NHS Wales has the potential to offer greater economies of scale. For example standardisation of policies and procedures can subsequently bring standardisation of processes and services. Currently each Health Board has developed their own policy and procedures for various FM related disciplines in total isolation. However, by introducing standardisation, this can offer a solution where all documentations can be developed centrally and made available to all Health Boards, thus significantly minimising developmental time and implementation costs further. This can also lead to a more integrated and cohesive NHS Wales.

6 CONCLUSION AND RECOMMENDATIONS

The discipline of FM is developing at an alarming rate and is gaining the prestige it deserves equal to that of other grounded and established professional disciplines such as engineering and architecture. Despite this high FM growth rate and may be this itself is one of the reasons that there is a significant variation in FM perception in both contexts i.e. FM as a whole and its individual components. The perception variation leads to variation in FM strategy and practices within the same organisation from its one branch to another. As a result, there can be unnecessary variations in cost, quality and time for delivery of the FM product or service from one branch of the same organisation to another. On the contrary, this is also understandable that FM cannot become a totally standardised discipline (at least not for all similar organisations in a given sector say the health services one), as variances will inevitably occur from one organisation to the other and what works for one may not work for others. However, it is crucial that FM is clearly defined, understood and appreciated within one organisational boundaries. This is where standardisation can come in.

FM implications are similar in NHS Wales as explained above. There is distinct variation on how the discipline of FM is perceived and delivered amongst the operating Health Boards across NHS Wales. To overcome this issue and resulting complications, ISO 41000 – specifically being developed for FM – is recommended to standardise FM and improve overall efficiency across the NHS Wales. In addition, this will also require other key considerations such as strong Health Bboard level as well as overall NHS Wales-wide leadership, a clear strategic direction, organisational ownership, organisation-wide transparency, integration and collaboration, and effective communication and information dissemination both vertically and laterally. Only through the combination of these factors, FM can be enabled to offer opportunities for cost reduction, quality enhancement and timely service. This way NHS Wales can become FM champion leading to successful innovation, offering economies of scale, and ultimately further improve overall business performance.

It is recommended that the findings of the research are taken on board by the NHS Wales top management and changes are planned and implemented accordingly. In addition, the NHS Wales Shared Services Partnership – Specialist Estate Services (NWSSP - SES) and the Welsh Assembly Government need to play a supporting role to assist in adopting ISO41000 across FM of NHS Wales. It is strongly recommended that Health Boards avoid the urge of implementing this in isolation and going off in their own direction. It must be test implemented first by an exemplar Health Board with close involvement and regular integration from all other Health Boards. Furthermore, timing is also crucial and although ISO41000 is still under development, a close eye needs to be kept on its developmental progress, rather than just waiting for it to become an adopted standard. An implementation plan needs to be put in place now, so that NHS Wales acquires a more readily accepting and implementing proposition when this International (Facilities) Management Standard comes out.

7 REFERENCES

- Nazali, M. and Pitt, M. (2009). “A critical review on innovation in facilities management service delivery”.
- Alexander K. (2003). “A Strategy for Facilities Management”, emerald, volume 21 number 11/12,2003p 269-274
MCP UP Limited, ISSN 0263-2772.
- NHS (Wales Health Service) Wales, 2017, Health in Wales, website: www.wales.nhs.uk, accessed:26/5/2017
- EFPMS (Estates and Facilities Performance Management System) data, (2014-15), website <http://howis.wales.nhs.uk/sites3/page.cfm?orgid=254&pid=10844>, accessed 26/5/2017.

Institute for Fiscal Studies (Survey of public spending in the UK), IFS Briefing Note BN43, website, <https://www.ifs.org.uk/uploads/publications/bns/BN43%20Public%20Spending%202014.pdf>, accessed:20/5/17

NHS (Statistics for NHS Wales) Wales 2017, Stats in Wales, website: www.statswales.wales.gov.uk), accessed: 26/5/2017

British Institute of Facilities Management (BIMF) (FM definition) Facilities Management Introduction <http://www.bifm.org.uk/bifm/about/facilities/> accessed: 26/5/2017.

BBC (BBC News 2016), 2016, website: <http://www.bbc.co.uk/news/uk-34224491>, accessed 18/1/16

GROWING TALENT GAP IN FACILITIES MANAGEMENT: NEED FOR ENCOURAGING AND ENGAGING THE NEW GENERATION

N. Gupta, M. Dixit

Construction Science, Texas A&M University, College Station, TX, 77840, United States

Email: Nancytamu@tamu.edu

Abstract: In the Facility Management industry, buildings and infrastructure are not the only things that are aging. The United States is currently at the peak of its retirement wave, with a disproportionately high number of people on the aging spectrum in this sector. With roughly 10,000 people expected to retire every day until 2030 and only 1% of college graduates reported to pick Facility Management as their professional career, there is a significant shortage in the FM workforce availability (IFMA 2016). This paper, through systematic review of the existing literature, publications, and theories, provides a comprehensive view on the critical issue of widening talent gap and the need for inspiring future generations of FM professionals. Despite graduating in science, technology, engineering and mathematics (STEM) field, only 48% of this generation is reported to be aware of Facility Management (Pesek c2017), which highlights the need of integrating FM as a part of the elementary and higher education system. This paper focuses on the analysis of existing literature in order to identify the reasons for the growing talent gap in FM industry. It also sets out the need for encouraging student participation and preparing the next generation, as a qualified workforce.

Keywords: Aging Workforce, Facilities Management, Facility Management Education, Future Of Facilities Management, Talent Gap.

1. INTRODUCTION

Facilities management is not just a task but a recognized profession. Facilities, besides being one of the largest assets of an organization, are also among the strongest. They represent a significant cost to a business (Flint 2016). With proper utilization and management of a facility, the value can be maximized while reducing the cost. Importance of efficient infrastructures and facilities and an effective system to optimize their maintenance is being realized by organizations worldwide (fmtalk360 2016). International Facility Management Association (IFMA) defined Facilities Management (FM) as “a profession that encompasses multiple disciplines to ensure functionality of the built environment by integrating people, place, process and technology” (IFMA 2004). In simpler words, it is about managing the people and the places to attain the best value for money, by creating a balance between the user and business needs. This in turn contributes to the performance and effectiveness of the organizations (Hightower 2013). A study conducted by IFMA in collaboration with Global FM - a worldwide federation of the FM member organizations, estimated the annual worth of the global facility management market to be USD 1.12 trillion in 2016. Paradoxically, notwithstanding its economic importance this industry is marred with number of issues. One issue that is muscling its way up the list in priority is the reality of facility staffing shortages (Schwartz 2014).

According to a recent U.S. Census Bureau report, 77 million baby boomers (people born from 1946 to 1965) are either retiring or are on the verge of retirement. This generation constitutes approximately 26 percent of the total U.S. population (Judkins, Morris and Moloczniak, 2011). While the wave of the retirement continues across the United States, this trend is predominant in facility management industry where the average age of a worker 49, whereas, the nation’s general working population has an average of 43 (Schwartz 2014). Clearly, the FM industry

will be exceptionally challenged to fill in its talent pool. With rapid expansion and the aging workforce, arises need for the people with right skills to perform the needed work. The key to closing this widening gap is recruiting the new wave of talent that's entering the workforce (Hightower 2013; Schwartz 2014). A study suggested that millennials (people born between mid-80's and late 90's) were expected to account for 47 percent of the U.S. workforce by the end of 2014. Surprisingly, only 1% of college graduates planned to choose facility management as their career (Pesek 2014) and often times this generation is unaware of career opportunities in the FM industry (Schwartz 2014).

There is substantial evidence that industry worldwide is facing talent challenges (Tarique and Schuler 2010), and the ability to develop, attract, and retain a needed supply of talent is a challenge facing the industry (Coy Ewing 2007; Tarique and Schuler 2010). In a 2008 Deloitte Research Study, it was noted that despite millions of unemployed worker, there is a severe shortage of talent. Resumes in abundance, yet companies still hectically search for the right talent (Athey 2008; Tarique and Schuler 2010).

One question that prompted this research was, what are the factors contributing to the growing talent gap in FM industry? This question seemed logical as there are several studies pointing the rising issue of talent gap but relatively sparse research on its causes has left room for further investigation. Therefore, the current study is an attempt to identify the reasons behind this widening talent gap in FM industry. It is based on the systematic analysis of the existing literature to investigate the factors which make this industry less appealing, and contribute to the workforce shortage. Also, this paper highlights the need to engage and expose the new generation to this potential, yet behind-the-scenes, field of Facilities Management.

2. METHODOLOGY

Systematic review of existing literature, publications and theories, and study of the narrative data has been adopted as the methodology to draw conclusions for this study. It is considered that systematic approach is a well-defined approach to review the literature in a specific subject area, and most likely generate a review that will be beneficial in informing practice (Hek and Langton 2000; Parahoo 2006; Cronin, Ryan and Coughlan 2008).

Initially the selection of the articles in this review was restricted to those published in leading academic journals. To identify top journals, sources like Google, Library resources of Texas A&M University, and University of Michigan- Flint Thompson Library Research Guide for Education were used. The list of journals includes: Journal of Facilities Management: EmeraldInsight, International Journal of Facility Management (IJFM), Facilities Management Journal (FMJ), Premises and Facilities Management (PMF), IFMA- Facilities Management Journal, and Journal of Facility Planning, Design, and Management (JFPDM). Because this search technique was slow and the number of articles identified through these journals was relatively small, this list was supplemented with popular FM websites identified through the Control Solutions Inc. blog (2014). Top facility management websites referred were: FacilitiesNet, Facility&Beyond, FMLink, Blog FMJ, Buildings.com, Today's Facility Manager (TFM), FM Magazine, and FM World. This combination drew satisfactory results and provided a base to this investigation. The top contributors were: (1) Journal of Facilities Management- EmeraldInsight; (2) Journal of Facility Management; (3) IFMA- Facilities Management Journal; (4) FacilitiesNet; and (5) FMLink. Further, the literature search was undertaken using electronic databases. After reviewing journals and websites, the computer

databases were the method of choice as it offer access to vast quantities of information easily and quickly (Younger 2004; Ryan and Coughlan 2008). Databases used primarily in this study were Google Scholar and Google.

Articles identification in all the above discussed methods was made through searching using index terms or key words. It is considered that the keyword searches are the most common method to identify literature (Ely and Scott 2007; Ryan and Coughlan 2008). In accordance with the subject of the study and relevance to context, key headings were selected for this review and they were: talent gap in facility management, facilities management workforce, FM education, millennials in facility management, issues in FM industry, and trends in facility management Alternative keywords with similar meanings were also considered like labor shortage in facility management, future of facilities management, talent gap in FM industry, and facility management degree programs. Literature search was mainly relied on “snowball” methods (pursuing references of references and using citation tracking). Similar approach has been adopted in several other studies (Greenhalgh 2004), and yielded considerable results.

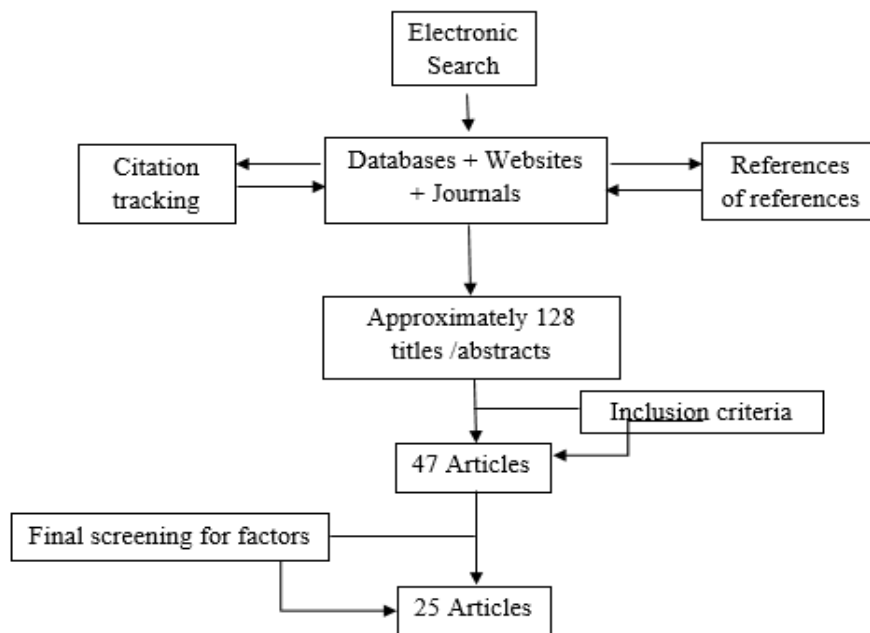

Figure 1. Summary of sources contributing to the systematic review

The breakdown of sources that contributed to the final report is shown in Figure 1. Initially, a first read of the collected articles was undertaken. The inclusion criteria were (1) studies from Facility Management sector; (2) those that had addressed talent gap in the industry; and (3) those that had looked specifically into the causes of labor shortage. But as the review progressed, it became evident that the studies meeting all the criteria was, incidentally, very sparse. Most of the literature was the general discussion on the issue of widening talent gap in the industry, and the studies conducted to specifically investigate into the reason for this gap were extremely limited. Therefore, the criteria was extended and the content of the collected articles was reviewed more systematically to address the question of this paper, i.e., what are the reasons for the growing talent gap in facilities management? With this scope in mind, a total of approximately 47 articles were identified from all the investigated sources. Further screening yielded 25 articles that addressed the concept for the reasons behind this talent gap and were relevant to this research.

For the further analysis, articles were then grouped based on the major concepts identified during review. Table 1 presents the literature analyzed in the form of matrix, which highlights these parameters and research studies supporting them.

Table 1: Concept matrix of reasons for growing talent gap in FM industry, source of the study, and year of the research.

Author/Source	Year of study/research	(1) Lack of awareness and exposure of FM as a profession	(2) Limited FM degree programs	(3) Non-alignment between the FM degree curriculum taught and the actual industry skill set requirements	(4) Large fragmentation and lack of differentiation of FM from other related disciplines
IJFM- Investigating the Facility Management...	c2017	✓	✓	✓	✓
Warren and Heng	2005		✓	✓	✓
Grisham, R.W.	2003				✓
Tay and Ooi	2001				✓
Paananen and Rochdi	2010			✓	✓
IFMA Facility management forecast	2007	✓		✓	
IFMA foundation Trends Survey	2004	✓		✓	
Nutt and McLennan	2000			✓	✓
Varcoe, B.	2002				✓
Lambert, et al.	1999				✓
Sanquist, N. J.	2015	✓	✓		

IFMA foundation-Making Facility Management a Career of Choice...	n.d.	✓	✓		
JLL Research Report-Millennial Interest in Facilities Management...	2014	✓	✓		
FMJ- IFMA	c2017	✓	✓		
Judkins, Morris, and Moloczniak	2011	✓			✓
Alexander, K.	2003	✓			✓
Hightower, R.	2013	✓	✓	✓	✓
Badger and Garvin	2007	✓	✓	✓	✓
National Research Council (NCR)	2001		✓	✓	
Ware and Carder	2012	✓		✓	✓
Sullivan, K.	2010	✓			✓
Hebert and Chaney	2011	✓			✓
Kumar, N.	2016	✓		✓	
Schwartz, H.	2014	✓			✓
Hutt and Jones	2016			✓	✓

3. FINDINGS AND DISCUSSION

The literature search identified four factors that contribute to the growing talent gap in facilities management. To record and analyze these identified causes, a matrix was designed (see Table 1). Through this matrix, the extent to which these causes are supported by each study is

reflected through the vertical column. These factors are discussed in detail in the subsequent paragraphs.

First, and the elementary reason identified from the review is the lack of awareness and public exposure of facility management as a profession (Ware and Carder 2012; JLL 2014; Hightower 2013; Schwartz 2014; Kumar 2016; FML-IFMA c2017). As the facilities management industry continues to be one of the most rapidly growing industries, generating skilled workforce and attracting candidates in large number from today's generation, remains challenging. The number of people of new generation entering into facilities management is much smaller than the older people preparing to retire (Sullivan 2010; Herbert and Chanley 2011). The profession need to increase its branding and outreach, as facilities management is often not in the top choices of today's new graduates (Kumar 2016). To support this, JLL (Jones Lang Lasalle) commissioned a research (2014) to examine the views of over 200 millennials who are college students or in professional jobs, and the key findings suggested that there is low awareness of FM in millennial talent, especially among college going students. This field does not attract millennials as compared to other industries, and one of the reason is less exposure of many millennials to the work of facility management (JLL 2014; FML-IFMA c2017). Revealed in a study conducted in the United States that a considerable portion of the millennials who are currently employed, work in science, technology, engineering or math (STEM) fields, and the skill sets they hold are relevant to the industry of facility management. However, only 43 percent have heard of this field, and barely 9 percent were identified to have a distinct understanding of the profession (Schwartz 2014; FML-IFMA c2017). Further supporting this, nearly 30 percent did not respond when asked in the study that, what facility managers do? Superficial responses such as "managing facilities" or only "managing" were offered by eighteen percent of millennials, whereas, nine percent mentioned "building or facilities maintenance" (FML-IFMA c2017). Among the people who are aware, only 36 percent are women, in contrast to 56 percent men, thus, suggesting gender biasness in the awareness of this field (Pesek 2014). Workforce development have been suggested as the key to the future of FM, but graduating only 2000 FM students per year when the annual demand is much greater than this is adding to the existing talent gap (IFMA Foundation n.d.). The answer to closing this gap is the recruitment of new generation talent, however this generation is often times unaware of this industry (Schwartz 2014).

The findings of this literature review revealed that there were several studies conducted previously which point out the overall lack of exposure of FM industry, and highlights the fact that very few are aware of what work actually entails in this profession. Facing this emerging challenge, the steps towards educating high school and higher education students about the opportunities in FM and its career path should be initiated, as it is important to advocate this profession to those who are yet to pick a career and enter the workforce. The industry needs proactive planning and strategies to expose the millennials to the field of Facility Management and its advantages (Alexander 2003; Judkins, Morris, Molocznik 2011). Despite the enormous potential and opportunities, facility management is not a career of choice among students and the young generation, which aggravates the problem and is one of the reasons identified for the shortage in workforce.

Another reason unfolded during literature search was the limited offering of FM degree programs (Badger and Garvin 2007; Sanquist 2015; Hightower 2013; Journal of Facilities Management 2017). It is a possibility that students may not even opt for higher education, but if at some point of time they choose to pursue, then first of all, they should be aware of FM as a profession and second, there must be ample options for FM education to convince them

(Sanquist 2015). Several efforts have been taken by different organizations to promote and facilitate the education opportunities in FM, but still they fall short to fill the growing talent gap (IFMA Foundation n.d.). One of the initiative by IFMA is a program called the FM “Registry”, which is a website aimed to recognize all facility management and related discipline programs worldwide (IFMA Foundation 2015). During literature search, the total number of FM degree programs: Associates, Bachelors, Masters, Doctorate, and Other degrees available in different geographical regions were calculated (see Table 2.) using this website (FM Academic Registry c2015).

Table 2: Facility Management Degree Programs

Geographical Location	Type of Degree	Programs recognized under the FM Registry	FMAC Accredited Programs
Asia	Associates	1	1
	Bachelors	2	2
	Masters	2	2
	Doctorate	1	1
	Other Degree	0	0
Caribbean	Associates	0	0
	Bachelors	0	0
	Masters	0	0
	Doctorate	0	0
Eastern Europe	Other Degree	0	0
	Associates	0	0
	Bachelors	1	1
	Masters	1	1
Western Europe	Doctorate	0	0
	Other Degree	0	0
	Associates	0	0
	Bachelors	5	3
	Masters	3	1
Oceania	Doctorate	0	0
	Other Degree	0	0
	Associates	0	0
	Bachelors	0	0
	Masters	0	0
North America	Doctorate	0	0
	Other Degree	0	0
	Associates	2	1
	Bachelors	9	8
	Masters	7	7
South America	Doctorate	1	1
	Other Degree	6	4
	Associates	0	0
	Bachelors	0	0
	Masters	0	0
Africa	Doctorate	0	0
	Other Degree	0	0
	Associates	0	0
	Bachelors	0	0
	Masters	0	0

As per a study conducted to analyze FM market for 33 countries, distributed between North America, South America, Europe, Middle East, Africa and Asia-Pacific, FM industry remains the most developed in Europe followed by North America (Transparency Market Research 2016; IFMA 2016). Contrary to its economic importance, it was found that there are only 9 degree programs in the Western Europe, and only 2 in the Eastern Europe, as shown in Table 1. Asia-Pacific was ranked as the fastest growing market with a projected rate of greater than 4.4% over the period of analysis (Global industry analysts Inc. 2014; Transparency Market

Research 2016). Surprisingly, this region too holds only 6 FM degree programs. On the other hand, Africa, Caribbean, South America, and Oceania regions have no degree program at all, for educating students in the field of facility management. Certain guidelines and criteria were established by Facility Management Accredited Commission (FMAC), for a program to be fully recognized as a provisionally accredited program (FM Academic Registry c2015). As listed under column 4 in Table 1, it can be derived that the number of accredited degree programs are even less than the total number of programs for most of the regions. These accreditation were aimed to assure the quality of courses offered by the universities and institutions, and to distinguish schools which adhere to a defined set of academic standards (IFMA 2017). Thus, it can be said that a good quality and standard education is even sparser in facilities management. Given the fact that IFMA is the largest professional organization for FM worldwide; it can be assumed that its influence on higher education can be hypothesized to the impact of many other FM professional bodies throughout the world (Journal of Facilities Management 2017).

A study by National Research Council (NRC) highlighted that only few schools, colleges, or departments are currently addressing the degree education in FM. In this research the profile of academic disciplines for many colleges and universities were illustrated through a graph in Figure 2 (Badger and Garvin 2007). It can be derived from the graph, that universities are producing considerably less graduates in FM than other disciplines such as business, law, engineering, and architect.

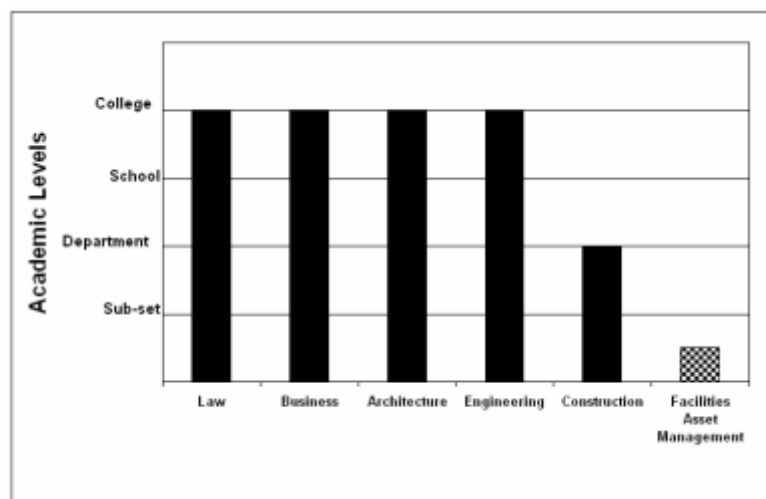

Figure 2: Typical Profile of Academic Disciplines (Badger and Garvin 2007)

Thus, it can be established from past studies that in future, universities need to introduce more FM degree programs, and expand education opportunities to prepare new talent for this industry. FM bug must be planted in students at early stage, so that they are aware of this profession before that take their career decisions. Alongside, increasing the number of facility management degree program worldwide for those seeking education in this field. The lack of awareness of facilities management as a profession is one factor aiding to growing talent gap, but having scarcity of education opportunities for those who are interested, is another reason that worsen the workforce crisis.

The third factor that can be attributed to the growing talent gap is non-alignment between the curriculum of FM degree programs and the industry relevant skills (Tucker et al. 2005; Warren and Heng 2005; NCR 2001; Hightower 2013). A study by Ware and Carder (2012) suggested

that recruiting younger generation to enter the facility management field was difficult, and the concern was that many of them were deficient in the basic skills needed for the success. It is essential to the future progress of the profession that there exist an alignment of degree courses offered by education institutions, with the skill-set required by the facilities management industry (Warren and Heng 2005; Hakkarainen & Korpivaara 2006). With the growth of this profession has come a need for not just any people, but the people with right skills to fill the responsibilities of those retiring. The study by Warren and Heng (2005) attempted to ascertain the skill set incorporated in the educational curriculum provided by universities in UK and Australia and then matched it with the core skills that the FM profession seeks. The research found significant gaps between the two, particularly in the area of key business skills. This study suggested that there is a requirement for industry and curriculum designer to coordinate more in future, with an aim to develop FM education which is in sync with the FM profession globally (Warren and Heng 2005).

The NRC committee conducted a literature search to identify skills and competencies needed for facilities managers, and revealed that these core skills are wide ranging (Badger and Garvin 2007). In a survey made by IFMA (IFMA foundation Trends Survey 2004), it was found that the key areas in which competencies should be developed were: Facility Function; Real Estate, Operations and Management, Human and Environmental Factors, Finance, Quality Assessment and Innovation, Planning and Project Management, Communication, and Technology. (IFMA 2007). In order to provide career essentials for FM industry professionals and to produce a qualified workforce with right set of skills, competencies must be developed in these key areas (IFMA Foundation Trends Survey 2004). Along with the development there is also a consistent requirement to follow the changes and update the skills in the current employees or workforce that is being prepared for the future (Paananen and Rochdi 2010). Often, education courses arise due to prevailing market needs and are targeted at practitioners. Given the fact that people come from diverse backgrounds, ranging from design engineers to business professionals, these degree courses must be designed to provide specialized knowledge for performing the role of a facility manager (Tucker et al. 2005). Whether one is a business manager or a degreed engineer, they must have an exposure to an education in FM - essential for the management of facilities (Crowley 2010).

Thus, the literature search highlights that to evaluate the skills of future manger, importance must be given to the current research in order to develop an idea on the specific skills that is required by facilities management industry (Hutt and Jones 2016). Universities must incorporate relevant skills in their FM degree courses, so that a qualified talent wave enters the workplace. Not only is it important to initiate more degree programs, but the alignment of these courses with the appropriate skills needed by the FM industry is essential to the future progress of this profession, and to tackle the widening talent gap.

The fourth and the last reason identified in this study was the large fragmentation of this industry and lack of differentiation from other related professions (Varcoe 2002; Grisham 2003; Sullivan 2010; Hightower 2013) Because of this, most often new generation is unaware of the career path in this industry, which makes it a less preferred choice than other disciplines (Schwartz 2014). Even though the awareness is on the rise, very few students opt for Facilities Management as their career (IFMA 2015.). In a study by Tay and Ooi (2001), it was indicated to an extent that despite rapid development in facilities management, this field still suffers from an identity crisis. It was mentioned that the scope and definition of FM is a debatable issue (Tay and Ooi 2001).

A study by Paananen and Rochdi (2010) reported that the versatility of the degree program can possibly confuse students, as they aren't aware of the type of profession they will be qualified for, due to ambiguity in career options or profiles. Such confusion does not appear to occur as frequently in other related professions (Tay and Ooi 2001). Due to large fragmentation of this industry, it can be perplexing for students to clearly determine their roles and future job positions, and choose FM as a career. Indeed, the profession has been referred to as a 'Jack of all Trades' (Tay and Ooi 2001) in that it is not clear if FM is a management discipline. Lack of branding, differentiation from other related professions (Warren and Heng 2005), and unclear vision regarding career paths can also suppress the otherwise generation of the FM professionals, thus adding to the existing talent gap.

Thus, it can be established from the systematic review of the existing literature, that blur boundaries in the scope of this profession and confusing career path has made it a less chosen field among the new generation. It was important to note that currently there are over 7,500 specific job descriptions that comes under the all-encompassing FM category (International journal of facility management 2017). These numbers are large enough to confuse the students and add to the vagueness in understanding the profession. Also, versatility of the degree programs can add to the doubt in students, regarding their career opportunities and roles in the future. This factor, of complexity in the nature of this profession, holds the potential to further worsen the existing shortage of talent in FM industry.

All the reasons identified for the existing talent gap in FM industry are illustrated in Figure 3. These parameters were found to be directly or indirectly interrelated, and are collectively found to be responsible for the growing shortage in facilities management profession.

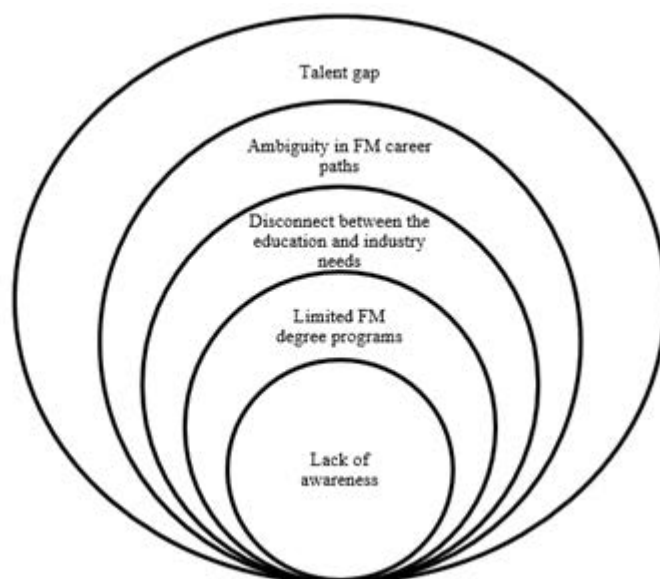

Figure 3: Reasons identified for the growing talent gap

One of the other outcomes from this systematic literature analysis was the relative lack of direct theoretical work on reasons responsible for the growing talent gap. Most of the existing literature in the area of talent gap in facilities management so far, has been premised on the general idea of the talent crisis. However, the studies that investigated into the factors contributing to this growing crisis were found to be very limited. A study by Hightower, R. (2013) has been instrumental and closely consistent with the findings of this study. The literature review on the topic being studied brings the up-to-date information on the existing literature and forms the basis for justification for future research. This study attempts to reveal

the reasons responsible for the existing talent gap in FM, and hopefully will serve as a knowledge base for further investigation in this subject.

4. CONCLUSION

This paper identified and provided insights into the different reasons that contribute to the widening talent gap. They are: (1) lack of awareness and exposure of facilities management as a profession; (2) limited FM degree programs; (3) non-alignment between the curriculum of FM degree programs taught in universities and the actual skill set required by the industry and; (4) the large fragmentation of FM industry and lack of differentiation from other related professions. This paper also discusses the need to educate new generation in order to prepare them as a qualified workforce of tomorrow. Another outcome from the systematic literature review was, that although this topic is widely discussed and acknowledged to have an important impact on facilities management, not many studies were found that specifically investigated the reasons for the growing talent in facilities management. Majority of the studies reviewed were aimed to point the subject of talent gap in general.

This paper is an attempt to review the existing literature systematically, and hopefully form a knowledge base for future investigations into the parameters contributing to the talent gap in FM. However, this study is limited to the current knowledge of the researcher. It lacks the empirical data and following results, thus calls for the future investigation into the exact reasons of the widening talent gap. Researchers are recommended to conduct empirical research to ascertain the factors identified through literature review in this paper. In short, the embryonic stage of research into reasons for talent gap in facilities management offers the potential for researchers to make meaningful contributions that are either methodological or empirical in nature.

5. REFERENCES

- Al-Abdulbaqi, Seraj, Abdulaziz Alobaydan, Ravi Chhibber, Abul Jamaluddin, Lynn Murphy, Kalyanaraman Venugopal, and Jeffrey D. Johnson. "Bridging the Talent Gap." *Oilfield Review* 25, no. 1 (2013).
- Alexander, K., 2003. A strategy for facilities management. *Facilities*, 12(11), pp.6-10.
- Amaratunga, D. and Baldry, D., 2000. Assessment of facilities management performance in higher education properties. *Facilities*, 18(7/8), pp.293-301.
- Athey, R., 2004. It's 2008: Do you know where your talent is? Why acquisition and retention strategies don't work. Deloitte Development LLC, pp.1-15.
- Steenhuizen, D., Flores-Colen, I., Reitsma, A.G. and Branco Ló, P., 2014. The road to facility management. *Facilities*, 32(1/2), pp.46-57.
- Badger, W.W. and Garvin, M.J., 2007, April. Facilities asset management: a new career field for construction management graduates. In Proceedings of the Associated Schools of Construction 43rd Annual International Conference, Flagstaff, AZ, USA, April (pp. 12-14).
- Baird, C. 2015. 5 myths about millennials in the workplace. [Online]. [18 April 2017]. Available from: <http://fortune.com/2015/04/13/5-myths-about-millennials-in-the-workplace/>
- Bonczek, M.E. and Woodard, E.K., 2006. Who'll replace you when you're gone? *Nursing Management*, 37(8), pp.30-34.
- Byrne, H., 2013. Talent Management and Succession Planning, Human Resources Strategies to Avoid a Skills Gap Forming During a Recessional Climate.
- Cowley, M. 2010. Continuing Education: Curriculum for Maintenance, Engineering Managers. [Online]. [15 April 2017]. Available from: <http://www.facilitiesnet.com/facilitiesmanagement/article/Continuing-Education-Curriculum-for-Maintenance-Engineering-Managers-Facility-Management-Facilities-Management-Feature--11985>
- Coy, P. and Ewing, J., 2007. Where are all the workers. *Business Week*, 9, pp.28-31.

- Cronin, P., Ryan, F. and Coughlan, M., 2008. Undertaking a literature review: a step-by-step approach. *British journal of nursing*, 17(1), p.38.
- Doyle, M.W., Stanley, E.H., Havlick, D.G., Kaiser, M.J., Steinbach, G., Graf, W.L., Galloway, G.E. and Riggsbee, J.A., 2008. Aging infrastructure and ecosystem restoration. *Science*, 319(5861), pp.286-287.
- Drion, B., Melissen, F. and Wood, R., 2012. Facilities management: lost, or regained? *Facilities*, 30(5/6), pp.254-261.
- Earle, H.A., 2003. Building a workplace of choice: Using the work environment to attract and retain top talent. *Journal of Facilities Management*, 2(3), pp.244-257.
- Flink, R., 2008. Guidance and counselling in the degree programme of facility management.
- Flint, N., 2016. *Fmtalk360*. HERE'S WHY YOU SHOULD TAKE FACILITIES MANAGEMENT SERIOUSLY. [Online]. [17 April 2017]. Available from: <http://www.fmtalk360.com/heres-take-facilities-management-seriously/>
- Global industry analysts Inc. 2014. Facilities Management- A Global Strategic Business Report. [Online]. [21 April 2017]. Available from: <http://www.strategyr.com/pressMCP-6261.asp>
- Greenhalgh, T., Robert, G., Macfarlane, F., Bate, P. and Kyriakidou, O., 2004. Diffusion of innovations in service organizations: systematic review and recommendations. *Milbank Quarterly*, 82(4), pp.581-629.
- Grimshaw, R.W., 2003. FM: the professional interface. *Facilities*, 21(3/4), pp.50-57.
- HARDY, V., 2004. The Future for Facility Management: Reading the Bones. *New World in*.
- Hebert, P. and Chaney, S., 2011. Enhancing facilities management through generational awareness. *Journal of Facilities Management*, 9(2), pp.145-152.
- Hek G, Langton H (2000) Systematically searching and reviewing literature. *Nurse Res* 7(3): 40–57
- Hightower, R., 2013, October. Investigating the facility management professional shortage. In *World Workplace 2013*. Ifma.
- IFMA Foundation. 2004. Current Issues and Emerging Trends Affecting Facility Management Now and Into the Future. [18 April 2017]. Available from: <http://www.ifmafoundation.org/CurrentEmergingTrends2004.pdf>
- IFMA. 2007. Facility Management Forecast 2007, Exploring the Current Trends and Future Outlook for Facility Management Professionals. [18 April 2017]. Available from: http://www.ifma.org/tools/research/forecast_rpts/2007.pdf
- IFMA Foundation. c2017. FM as a Career of Choice - The IFMA Foundation's Global Workforce Initiative. [Online]. [14 April 2017]. Available from: <https://foundation.ifma.org/global-workforce-initiative>
- IFMA Foundation. c2015. FM Academic Registry. [Online]. [16 April 2017]. Available from: <http://fmacademicregistry.org/degree-search/?geo=north-america>
- IFMA Foundation. n.d.. Making Facility Management a Career of Choice by Expanding Educational Opportunities. [Online]. [16 April 2017]. Available from: https://foundation.ifma.org/docs/default.../ifma_brochure_single_pages_rev5.pdf?
- IFMA. 2016. New study finds US\$112 trillion annual facility management market impact. [Online]. [18 April 2017]. Available from: [https://www.ifma.org/news/what's-new-at-ifma/what's-new-at-ifma-details/2016/09/16/new-study-finds-us\\$1.12-trillion-annual-facility-management-market-impact](https://www.ifma.org/news/what's-new-at-ifma/what's-new-at-ifma-details/2016/09/16/new-study-finds-us$1.12-trillion-annual-facility-management-market-impact)
- IJFM, c2017. Investigating the Facility Management Professional Shortage. *The International Journal of Facility Management* [Online]. [18 April 2017]. Available from: <http://fmlink.com/articles/investigating-the-facility-management-professional-shortage/>
- Judkins, C., Morris, J.P. and Moloczniak, C., 2011. Utilizing Interns in Facilities Management. *Facilities Manager*, 27(6), pp.24-27.
- Kashiwagi, D., 2012, November. New leadership model: changing the playing field. In *IFMA World Workplace Conference*.
- Kim, J. and Yang, Y.C., 2013. What can we do to Attract and Retain Young People to our Company as we find it Difficult to Attract Employees at all Levels?
- Kumar, N., 2016. *Fmtalk360*. Is Facility Management A Doomed Profession? [Online]. [17 April 2017]. Available from: <http://www.fmtalk360.com/facility-management-doomed-profession/>
- Lambert, S., Kagan, L. and Poteete, J.S., 1999. *Leading-Edge Corporate Real Estate: Services in Transition*. International Development Research Council.
- Mari, M. and Poggesi, S., 2014. Facility management: current trends and future perspectives. *International Journal of Globalization and Small Business*, 6(3-4), pp.177-192.
- Mudrak, T., van Wagenberg, A. and Wubben, E., 2005. Innovation process and innovativeness of facility management organizations. *Facilities*, 23(3/4), pp.103-118.
- National Research Council, 1998. *Stewardship of Federal Facilities: A Proactive Strategy for Managing the Nation's Public Assets*. Washington, D.C.: National Academy Press.
- National Research Council, 2001. *Outsourcing Management Functions for the Acquisition of Federal Facilities*. National Academies Press.
- Nutt, B. and McLennan, P., 2000. *Facility management: risks and opportunities* (p. 278). Blackwell Science Ltd.

- Paananen, H. and Rochdi, M., 2010. Developing ideas for the curriculum in facility management: competences and future prospects.
- Parahoo K (2006) *Nursing Research – principles, process and issues*. 2nd edn. Palgrave, Houndsmill
- Pesek, C., c2017. Tapping the Millennial Talent Pool. *Facilities Management Journal- International Facility Management Association*. [Online]. [16 April 2017]. Available from: <http://fmlink.com/articles/tapping-the-millennial-talent-pool/>
- JLL Research Report, 2014. Millennial Interest in Facilities Management- The Key to Closing the Growing Talent Gap. JLL [16 April 2017]. Available from: www.us.jll.com/.../millennial%20interest%20in%20facilities%20management%20june
- Roper, K.O. and Borello, L.J., 2013. Evolution and the Future of Facility Management. *International Facility Management*, pp.167-177.
- Sanquist, N. J., 2015. Closing Achievement Gaps in High Schools and Community Colleges. *Facilities Management Journal- International Facility Management Association*. [16 April 2017]. Available from: https://foundation.ifma.org/docs/default-source/.../fmj_sep-oct_2015_sanquist.pdf?
- Schwartz, H. 2014. Millennials and facilities management. [Online]. [16 April 2017]. Available from: <http://www.us.jll.com/united-states/en-us/services/corporates/facility-management/millennial-talent>
- Sullivan, K. (2010), “Empirical study of the current United States facilities management profession”, *Journal of Facilities Management*, Vol. 8 No. 2, pp. 91-103.
- Tay, L. and Ooi, J.T., 2001. Facilities management: a “Jack of all trades”? *Facilities*, 19(10), pp.357-363.
- Tarique, I. and Schuler, R.S., 2010. Global talent management: Literature review, integrative framework, and suggestions for further research. *Journal of world business*, 45(2), pp.122-133.
- Then, D., 2004, June. The future of professional facility management education in the Asia-Pacific region. In *New World Order in Facility Management Conference*.
- Transparency market research. 2016. *Facilities Management Market - Global Industry Analysis, Size, Share, Growth, Trends and Forecast 2016 - 2024*. [Online]. [16 April 2017]. Available from: <http://www.transparencymarketresearch.com/facilities-management-market.html>
- Tucker, E., Kao, T. and Verma, N., 2005. Next-Generation Talent Management. *Business Credit*, 107, pp.20-27.
- Varcoe, B., 2002. The performance measurement of corporate real estate portfolio management. *Journal of Facilities Management*, 1(2), pp.117-130.
- Ware, J.P. and Carder, P., 2012. Raising the bar: enhancing the strategic role of facilities management. A publication of the Royal Institution of Chartered Surveyors (RICS), London available at www.rics.org [Accessed on April 14, 2017].
- Warren, C.M. and Heng, S.K., 2005. FM education-are we meeting industry needs. In *PPRES 05: Pacific Rim Real Estate Society 11th Annual Conference* (pp. 1-20). Pacific Rim Real Estate Society (PRRES).

YET ANOTHER TROJAN HORSE? IS FACILITY MANAGEMENT READY FOR DIGITALISATION?

C. Koch¹, G. K. Hansen² and K. Jacobsen³

¹ Architecture and Civil Engineering, Chalmers University of Technology, 42196, Gothenburg, Sweden

² Department of Architecture and Planning, NTNU, NO-7491 Trondheim, Norway

³ K-Jacobsen AS, 4621 Gadstrup, Danmark

Email: Kochch@chalmers.se

Abstract: Digital practices of facility management (FM) are still rare. Several Nordic countries have ambitious hospital building projects, driven by large public clients with long term experience of operating complex building campuses. There is thus an opportunity of creating state of art regarding digital FM. However, a recurrent problem is that a technically focused implementation leads to prolonged learning and practice development in the involved organization and never get operational. Hence members of organisations successfully resist the perceived Trojan horse entering. This paper aims at investigating the role of digital FM in new hospital projects in Scandinavia. Based on a literature review, a framework of understanding of digital FM in hospital operation is established. This highlight the importance of integration between technical digitalization, competences, organization and management of digital FM. Two longitudinal cases are presented and analysed. A greenfield hospital and an extension of an existing hospital. The projects are in different phases and represent quite advanced preparations for digital FM. State of the art software FM system are prepared before operation. External consultants are involved, posing a dilemma of inhouse/outsource human resources in the future digital FM operation. The importance of managerial, organizational and competence preparation is highlighted as implication.

Keywords: Digitalisation, Facilities Management, Hospitals, CAFM, BIM, Scandinavia

1. INTRODUCTION

Throughout almost four decades of IT implementation and use in organisations, reports of non-successful, complicated or even scandalized cases has been recurrent (Flyvbjerg & Budzier 2011, Hastie, & Wojewoda, 2015, Landauer 1995, Sauer & Willcocks 2007, Standish Group 1995, 2000). Time and again the IT industry have sold rosy visions, which has turned into protracted processes of internal excessive man hours spent for learning and modifying systems and practices. In this perspective, the comparison with a Trojan horse is fair. An organisation accepts an apparently simple purchase of software and end up spending most on everything else; consultancy hours, training etc. Any organisation embarking into IT implementation should therefore be weary of what might come.

Real estate administrators investing in FM software is no exception (May 2013, Volk et al 2013). Even the documented research on the issue is scarce, the implementation in existing buildings is limited according to Volk et al (2013), due to challenges of conversion efforts from captured building data, updating of information and handling of uncertain data, objects and relations occurring in existing buildings. This is moreover probably just a small excerpt of the barriers encountered. Following Volk et al (2013)-s findings most BIM integrations in FM have been done in newbuilt projects the later years. New building is therefore a chance, if not the only chance, for the operations and maintenance organisation (O&M) and the client for taking a quantum leap in digitalization of FM.

The healthcare sector represents an important part of the Scandinavian welfare states (WHO 2009) and these countries invest the most in Europe (WHO 2009). Hospital administrators have extensive facilities management competences and experiences. In these years we witness an unprecedented wave of investment in renewal and extension of this infrastructure. Norway thus invested an estimated 10 billion Euro in new hospitals from 2000 to 2011 (Hågoy 2013), and Denmark has announced future investment at 5,5 billion Euro (Danske regioner 2011). Sweden as well invests in large projects in its major cities and generally (OECD 2013). Under these circumstances one can expect a trailblazer use of digital FM, including the use of Building information modelling, BIM.

The aim of this research is therefore to investigate the role of digital FM in new hospital projects in Scandinavia.

A literature review of digitalization of FM is carried out, to form a framework of understanding of digital FM in hospital operation and maintenance (O&M). This highlights the importance of integration between technical digitalization, competences, organization and management of digital FM.

Digitization is here defined as the use of information and communication technologies such as BIM, software, big data technologies, Internet of Things (IoT), augmented reality, digital twins, block chains (a distributed ledger for value exchange), building information standards (Gartner 2016).

Two longitudinal cases of hospital design are presented and analysed with a focus on their preparation of the facilities management. One is a greenfield hospital, the other a 22.000 square extension of an existing hospital. While the projects are in different phases they both represent quite advanced preparations for digital FM.

Abbreviations used; CAFM is Computer Aided Facility Management system. CAFM and FM system is used interchangeably for software applications in FM.

The structure of the paper is the following. It commences with a selective review of literature and material on digitalization in FM. Second a method section describes how the paper will respond to its aims. This is followed by a description of the two cases. On this basis, we discuss first each case and then identify some common features. The paper sums up its line of argument in the conclusion.

2. LITERATURE REVIEW

Below, first is identified digitalization opportunities and then second discussed how the literature deal with contribution to digitalization in facilities management.

2.1 Digital transformation opportunities

Bilal et al (2016) evaluate, review, and develop big data opportunities in the construction industry. They identify big data analytics (such as retrieval of knowledge from maintenance databases) and big data engineering applications in the sector through a literature review. Within FM they find existing systems having inefficient time consuming searching interfaces,

a lack of unified interfaces for FM system to exchange information, and inability to store and process large volumes of data generated by these systems. They also posit that the efficiency of many labour intensive activities could be improved by big data technologies, such as localisation information technology (including location of FM personnel) but also advanced automation and integration to measure, monitor, control, and optimise building operations and maintenance. According to Bilal et al (2016: 514) “they provide adaptive, real-time control over an ever-expanding array of building activities in response to a wide range of internal and external data streams. As investment ramps up and more intelligent systems are brought online, more data will enter the energy management platform at faster speeds”.

The Internet of Things (IoT) is enabled by miniaturisation and empowerment of the needed devices, and the broadband connectivity is getting cheaper and ubiquitous (Bilal et al 2016). This implies that an IOT-based framework for building energy monitoring and smart buildings becomes possible. Data of sensors relates to motion, CO₂, temperature, airflow, lighting, and other acoustics properties are gathered and analysed (Bilal et al 2016) The applications of IOT are however non-trivial and often deploy hundreds or even thousands of sensor devices for data collection. Also, generating large volumes of data, which mean storing and analysing these data will be a challenge for FM organisations (Bilal et al 2016).

Digital twins are a vision of every other physical thing should have a twin, a dynamic software model of the thing (Gartner 2016). The software developer and vendor SAP is currently developing a digital twin system for real estates (Galer 2017). The digital twin should contain unified digital representation of every asset that comprises a physical building collected via sensors across its life cycle (Galer 2017). Stakeholders involved in a building (such as suppliers of repair) would then receive a digital key to enter the twin and extract the relevant information they need.

Blockchain, according to Galer (2017) provides a neutral collaboration and information-sharing platform that each participant in a real estate management uses to support processes including contracts, regulatory compliance and transactions. Blockchain for real estate is a current development area for SAP for their FM customers.

Gheisari & Irizarry (2016) study mobile augmented reality integrated with BIM. They observe that facility managers are physically mobile at the spaces they manage. However their survey show a bit more mixed pattern as the investigated facility managers spend more than half of their working time sitting, 21 % standing and 21% walking around the facility. A portable, mobile device integrated with a BIM model, could according to Gheisari & Irizarry (2016) provide on time and on place information and geometry of objects in the facility, the data and 3D geometry information extracted from BIM can then be augmented on the facility manager’s live view as a “transparent window” (Gheisari & Irizarry 2016: 72)

Information standards can be viewed as important tool for improving interoperability in a digitalized infrastructure of systems, interfaces and communication technologies (Bilal et al 2016, author reference). Building information standards are currently developed both globally (Building Smart, EU, ISO) and nationally (author reference). Some but not all building information standards are prepared for supporting facilities management and thereby some are important tools of digitalisation when including transfer of new built information to an O&M organisation, whereas other reconstruct a gap between design, building, and operation.

Finally, digitalisation of facilities management will require an integration between technical digitalization, competences, organization and management of digital FM. As Volk et al (2013) posits this is also the comprehension in the BIM in FM literature. Studies of these aspects have proposed the notion of hybrid practices to underline this important integration (Whyte 2011).

2.2 Facilities management and digital transformation

Although Atkin & Brooks (2014) is a guidance publication it contains interesting views of IT in facilities management through a lens of “information management”. Atkin & Brooks (2014) point to use in FM of singular systems CAFM, CMMS, ERP, scheduling and Design Build BIM, yet does not mention digital transformation, information infrastructure issues or opportunities of “big data” analytics and engineering (Bilal et al 2016). There is even a tendency of favouring existing proprietary system (Atkin & Brooks (2014: 328) and problematising the FM benefits of investing in BIM technology (ibid 302). However, more indirectly issues of information infrastructure such as interoperability and transfer of data is dealt with through mentioning of standards and model view definitions for FM. Atkin& Brooks views such issues as related to new build an point to that facilities management should try to assure that the relevant data and information for FM is produced during design and construction of a new building.

A similar status is valid for other recommendation of implementation of IT in Facilities management (Levitt 2013, Madritsch and May 2009, May 2013, Teicholz 2013). Despite their recent publication their focus is on CAFM systems implementation and/or use of BIM, but they contribute in limited manner to contemporary digitalization of FM.

Volk et al (2014) review 180 journal articles on BIM use in building management. They find that Bim in 2014 still is in limited use in maintenance and facility management. BIM is found mostly in recently constructed buildings. There is growing attention to the need of collaboration, there is still legal and interoperability issues that need to be tackled. Volk et al (2014) do not discuss any particular software or technology. They identify a BIM in FM understanding that appreciates the collaboration, organisation and managerial aspect of IT in FM. This will here be understood as important elements of an emergent digital practices in FM. For example one aspect is the transformation of BIM models containing as built information into reduced and accommodated information models systems (sometimes denoted Asset Information Models AIM).

Summarizing, there are range of technologies emerging that appear to enable digitalization of FM, including BIM, software, big data technologies, Internet of Things (IoT), augmented reality, digital twins, block chains and building information standards. However, to commence realizing digitalisations a process of creating hybrid practices of combined digital technologies, competences, organisation and management have to be developed.

3. METHOD

The approach adopted here is qualitative case studies supported by a document and literature study using an interpretive approach. Two case studies of new built hospitals in Scandinavia have been carried out.

The first case is a University Hospital, where a new building on a existing campus is made: 18 interviews in total. Two rounds of interviews with the Facility manager and one group interview with employees in the facilities management department of the hospital. Interview with other players; contractor's project manager and design manager, client's project managers, architects (2) and consulting engineers (3). These interviews was focused on the building project, but also involved the topics related to future facilities management. The CAFM system used in this case is a system also from Scandinavia with most customer in the case country, we therefore label it with a pseudonym SCAN FM here. Similarly, the building information standards are nationally specific and to some extent even local and specific for the hospital studied, and therefore also renamed CLASSSYS 1, 2, 3.

The second case is a greenfield Regional Hospital project that also encompasses research functions and therefore resembles a university hospital. It has not been possible to interview facility managers as the hospital is new. Most of the empirical material therefor focus on the ongoing design and building project. Here 34 Interview with a series players have been carried out; design managers, client's project managers, architects (2) and consulting engineers (3). These interviews was focused on the building project, but also involved the future facilities management.

The CAFM system used in this case is also system also from the Nordic Countries labelled NORDFM here. And the building information standards are nationally specific and therefore also renamed CLASSSYS 4.

The research is carried out within the frame of a Nordic project with Nordic partners.

4. UNIVERSITY HOSPITAL

Case 1 is a 22 000 m² transformation and extension of an existing university hospital in Scandinavia. 13 000 m² will contain polyclinics, test laboratories, day surgical department including operating rooms and day care centers, intensive care department, rehabilitation department, and clinical-medical laboratories. In addition, the conditions in the existing emergency reception are improved. 8000 m² will be demolished and reconstructed. In connection with the construction a number of renovations are carried out in the adjacent parts of the building, to ensure effective functional relationships between the new building and the existing hospital. Total budgeted costs of 170 million Euro milliard NOK. The project is expected to be finalized in 2018. The design of the project was done with different software programs like Revit and Autocad, but put together in a portfolio of Building Information Models and continuously coordinated by a BIM coordinator from the architect company. The early conceptual phase commenced using dRofus, a room programming tool. The use of dRofus, a standard tool for the national and regional health authorities continued in the process. The module for room classification and unique numbering of rooms and the function program was used. dRofus also offers a modul on Facilities Management handover, TIDA (Technical Information Database) where contractors have access to upload all FM documentation related to "their" systems and components providing accurate and consistent FM numbering of all objects using CLASSSYS1. CLASSSYS1 for the building components and technical installations in construction is used to a certain degree.

The CAFM system's database, SCANFM, is built up in an intersection between two national classifications and one local. The two national is first CLASSSYS1 which is a standard for

classifying building component. Second CLASSSYS 2 that is a hospital classification systems used to classify rooms. These two are not precise enough to meet local needs and therefore a third system, CLASSSYS 2 is in operation locally. It seems that the main focus from the consultants and the main contractor is on buildability. The O&M department at the hospital does not seem to have any strategy to tackle all the data and material that are produced in the project.

The architect's BIM coordinator did a lot regarding classification for the architectural design on building elements and components. The engineering consultants did not do this to the same degree. The client was in the start uninterested in digitalization issues.

Until recently facility management in the hospital was based on 2D and Autodesk, now implemented in SCANFM to handle the relevant information of the building. SCANFM is the system for O&M. dRofus is not been used here. Challenges regarding how the classification and coding in dRofus is organised and how the different software design software and the engineers traditional way of coding is done.

The main gain using SCANFM is that all the information needed is located in one system. SCANFM does not make any barriers towards BIM. The O&M organisation and especially the FM manager experiences that they can import data directly into SCANFM. But they have to do it manually in order to transfer data from the project into their system, and then transfer it to the national system – again using excel. They have a classification already in SCANFM, but they have to rename it following that system. They have used external consultants to do this, but the project group think that the system is a bit heavy. They hope to avoid to put in all the information manually in the new system. The hospital has a standard for it, but there is a need to find out what level of information and detail. They must find a common standard for this for all hospital projects. SCANFM is not flexible at all. The version purchased at the hospital is based on PC and cannot be carried around where its needed. But it works, even it is not the most user friendly. They should rather use the common multidisciplinary marking system, CLASSSYS 1. But there are some variations regarding understanding and practice. For the engineers in the design phase, this is a change of practice from marking of building systems and components related to drawings. It is another systematization than they traditionally have been using. It is hard for consultants to take this, and they do not really see the consequences.

The CLASSSYS 1 does not catch up all the components as it goes down to a certain level of detail and is not really sufficient. The O&M department are missing a lot of data. They need to put some more data into the system still. They do not have plans for using CLASSSYS 1. They have their own version based on another national standard, not so different from CLASSSYS 1. The O&M representative posits that there should be a common national standard instead of each hospital have their own system. The idea is that CLASSSYS 1 is a common national system that enables hospital organisations to compare apples with apples.

The O&M organisation posits that they have not learned about any good examples on use of BIM regarding documentation for operation and Facilities Management. All the design information on technical rooms, installations, room numbering is based on 2D and Autocad. They have not implemented drawings in BIM yet, but the interpretation is that the organisation do not loose that much on not having BIM. The information from one system is supposed to be integrated into the OM system. Different software shall communicate and different clients and organization does not necessary have the same systems. They use a lot of time to collect

information on management and operation. They use excel to collect data, to process the data and put into TIDA (Technical Information Database). To day this is not done seamless.

The operation organisation is represented in the design built project organisation, equipped with a budget for changes in the design to prepare FM. SCANFM is being prepared before operation. External consultants are involved in this, posing a dilemma of inhouse/outsource human resources in the future digital FM operation. The O&M department is well represented in the project. They have a good collaboration and communication directly to the head of the hospital. The real estate executive manager is directly under the CEO of the hospital. The O&M organisation view themselves as lucky, because they experience they are being heard. However, at a time the O&M organisation is clearly constructed into an inferior side-waggon position in need of more influence, continuously placed in a role of accepting others decisions. The project has given the O&M organisation some experiences. They want to make a systematic plan where their experiences on operation and management is described. A plan for training and handover. It is important that their knowledge and experiences are taken into consideration, but it is also a certain risk that this will lead to more conservative solutions.

5. REGIONAL HOSPITAL

Case 2 is part of 140.000 m² design of a new regional university hospital in Scandinavia. The total budget is approximately a half billion Euro and the overall design and construction project is divided in several overlapping sub-projects. As a strategic choice, each sub-project was assigned to different teams from different companies. There is few design or construction companies involved in more than one sub-project.

This case is mainly covering sub-project two, which consist of design of two buildings:

- A somatic department, including cancer, neurology and day surgery. The department is a multi-story rectangular building.
- A Service Center containing service functions for the hospital such as kitchen and laundry. this is mainly a two-story building.

The design of the somatic department and service center commenced with a design brief in January 2014, and the construction of the service center started summer 2016. The Service center is planned to be ready for operation in 2017 and Somatic department at the beginning of 2020.

The building project client project organisation, representing the owner of the hospital was foresighted as the project manager from early beginning of the project had a clear vision of the value of digital information, which is created during the project. If all created design and construction information should be an applicable and productive foundation for the future operation and maintenance of the hospital, the information must be very well and consistent organized, according to this vision. Moreover, it was posited that the key to a productive and cost effective operation and maintenance was the possibility to transmit the design and construction data into a digital FM-system during the design and construction process. This required a quest of realizing an unambiguous data structure and data discipline from all involved teams of the different sub-projects. Otherwise the hospital's future O&M department will be constrained in gaining benefit of all ideas and thoughts, which lay behind the design, construction and selection of components and technical systems in the project.

Therefore the representative of the owner chose that the entire hospital project should use a common classification system, which was able to support classification of all types of design and construction objects. A new developed national classification system CLASSSYS 4 was chosen, as the developer of the classification system claimed that the system supports a homogeneous object classification during all phases of a building project, from design brief to operation and maintenance. That means that created objects from the design brief would have the same classification in the operation and maintenance phase, even though the object was changing type and data properties during all design and construction phases.

Therefore, this hospital project was the one of the first building projects that should use a new classification system for structuring all building components and technical systems as well as rooms.

5.1 Classification system and CAFM-system

The idea of using a common classification system was to make up a general data-infrastructure of all digital project information. A classification system should be a structuring element in all type of information - even from drawings, documents and folders to BIM objects and quantities in the tender list etc. And the main purpose for all this was to gain structured digital data and information to support the future digital FM-system of the hospital, which however at the time still wasn't purchased.

The design team in the first and largest sub-project had to build up a generic object library structured in accordance to the classification system. The object library contains property information of each type of object and what type of information the contractor should deliver, when he should deliver a constructed building. This library was crucial for the type of information the owner could expect to be delivered in their future FM-system.

While the design process was well started of the first sub-project, the owner purchased a "traditional" CAFM-system NORDFM.

One main focus of the CADFM-system's functionality was its ability to import BIM data structured by the classification system CLASSYS 4, thus it was able to import the CLASSYS 4 structured handover information from the final design and as built phases. The purchased NORDFM had the ability to import the BIM-data in IFC-file format, but the software vendor had to extend the software import function, to support data structured according to CLASSYS 4.

During the construction period, import of design BIM data was imported to the NORDFM and the realization of the huge amount of different types of objects (building components) imported the system occurred for the representatives of the future O&M-department.

5.2 Need for a common project object library

In sub-project number two the design team created their own generic object library for BIM handling. It was structured according the CLASSYS 4 and build up similar to library of the team in sub-project one.

But during the design phase, when the designer and O&M-department representative tested the import of the design BIM data, it was quite clear, that the types of objects and the information level of the objects was total different in the two sub-projects design BIM data, even though the most objects represent the same physical type of building component. The cause for the difference, was mainly the team different interpretation of use of CLASSYS 4 and object naming and the different focus of information needed in the BIM to design, tender and construct the two sub-projects.

The difference was shown in NORDFM was the number of objects was doubled and the future O&M-department had to focusing more objects in the NORDFM-system, even though the objects is the same type of physical object.

As a result of the test the owner invested in creation of a one common BIM object library, based on the sub-project structured in accordance to CLASSYS 4. All sub-project's design and construction teams afterwards had to use this owner-specific object library to ensure the same object definitions and information level was correct delivered into the NORDFM-system.

5.3 FM benefits of a common project object library

The case 2 showed that creation of a one common BIM object library was necessary for fulfilling the vision of that data created in early design and construction should be an applicable and productive foundation for the future operation and maintenance of the hospital.

Different design teams tends to define and structure BIM objects differently. Also if they structure the objects in accordance to a comprehensive classification system, as CLASSYS 4. In this case the classification system wasn't enough. The designers interpretation of needed types of objects was clearly reflected in the use of design objects and the objects needed level of information.

To ensure that the NORDFM-system didn't contain redundant objects definitions it dawned for the owner, that he had to take action and invest in a common project object library for the whole hospital project.

The benefit of a common project object library will surely results in that the O&M-department get a consistent FM-tool NORDFM for managing their future work, as the digital content represent the real physical components and technical systems, even though the components and technical systems where designed and constructed by different teams in different sub-projects.

Another major benefit is the re-use of object definitions. In the following sub-projects the design and construction teams had to use the predefined project object library. This has resulted in that the design teams had started their design process much faster, as the owner simply had removed their work of defining and structuring objects in the beginning of the process. In fact, this resulted in an appreciable acceleration of the design process.

One conclusion you might can make of the case is that that larger building owners and O&M-departments advantageously can build up their own object library, and require that design and construction teams has to use it – and eventually extend it with new types of objects - thus to ensure that the handover of FM-information from the design and construction phase to the CADFM-system proceed efficient and consistent.

6. DISCUSSION

The university hospital is extending a recent FM system investment for the new built, which make the new system better integrated and supported by hybrid practices. The client organisation in the building project is however relatively passive in the digitalization issue and it is the BIM coordinator from the architect company which is the driver behind digitalization initiatives such as proactive use of building information standards and BIM.

In the university hospital case, there are several national systems for standardization and classification that are partly used. But the systems used in the design phase has mainly been focused on buildability. The university hospital has recently invested in a PC based FM system that is not directly integrated or communicated with the other systems, this is in line with Bilal et al (2016) that states that existing systems have a lack of unified interfaces for FM system to exchange information.

In the university hospital case FM managers and operatives were understood as mobile (as in Gheisari & Irizarry, 2016), yet the organisation consisted of both more office based members and mobile members.

The regional hospital has made a new investment in the FM system, and is still predominantly in a waiting position in building hybrid practices in the O&M organisation. Therefore there has been a predominant technical focus. Through the building project the database and its classified information structure has been prepared for future operation, but few if any of the future O&M have been involved. In this case the project manager of the clients building organisation is the main driver.

When comparing the case findings with the review of digital transformation it becomes clear that even with very recent investment in IT the two hospital cases are quite far from the leading edge digital transformation. There is even evidence in one case that hospital management constrains this development.

Several of the digitalization opportunities, such as IoT and smart buildings, is actually mentioned in a recent national proposal for digitalization in the country of the university hospital. This involves commencing creating smart building at hospital equipping the building with monitoring sensors. In the country of the regional hospital however such common strategy is at present absent. In such absence one can turn to developing a local strategy and to use external partners. In this perspective it can be speculated that the choice of relatively small Scandinavian/Nordic CAFM system suppliers might miss a possible strategic partnership of digitalization.

Also, it becomes clear that converting BIM to AIM is a challenge. In both cases it appears like the O&M organisation is going to take over all as built information, without restructuring it for support for FM.

The Trojan horse phenomenon has occurred in both cases. Subsequent to investment on the FM system both hospital organisations have needed to use external consultant to help in structuring and building up the data for the systems. In the university hospital case on the job learning and training has been arranged for the O&M personnel. Sofar the regional hospital competence development has been in the building project organisation as a future O&M organisation is still not established. The Trojan horse phenomenon is likely to continue. Also

in the future we will witness IT investments which get accompanied with hundreds of hours of internal hours invested to make the systems work and accommodating routines, not to mentioned outright failures of adoption. Gartner for example predicts that most cloud ERP project will fail in 2018 (Clarke 2016). One might therefore adopt the lukewarm approach suggested by Atkin & Brooks 2014, which wait for more solid practical business cases of CAFM, whereas we suggest the (burning) issue of FM organisations today, is to consider digital transformation of FM. This is a “too early too late” dilemma where too early embarking leads to having to handle “children’s diseases” whereas too late means missing important opportunities of IT use. Our two cases do seem to be late, compared to opportunities of digital transformation, yet still on a par with the contemporary Scandinavian FM community. This nicely illustrates the dependency of access to knowledge and experiences, which tends to be limited to national communities.

7. CONCLUSIONS

The aim of this paper was to investigate the role of digital FM in new hospital projects in Scandinavia. Drawing on recent research it was observed that creating new buildings appeared to be an important opportunity for hospital operation and maintenance functions to lever their digitalization level. A framework of understanding was developed through literature study, finding a range of technologies supporting digitalization of FM, apart from state of the art CAFM system, BIM, big data technologies, Internet of Things (IoT), augmented reality, digital twins, block chains and building information standards. However, the idea of the Trojan horse was to highlight the strong need to commence realizing digitalisations in a process of creating hybrid practices where competences, organisation and management are developed that together with the technologies can make a digitalization that perform in practice. The two cases show that the development of national standards for classification of building systems, elements and components have been developed over years, and the different system also are more aligned and consistent than previously. We also recognize that building information models, BIM, is used as a platform in order to handle the information throughout the whole lifespan of a building. However, one of the big challenges is that if the systems used in the design and construction phase are not aligned to the FM system used in the hospital, all the information collected either will not been used or have to be imported using unnecessary time and resources. The metaphor of the Trojan horse as a bearer of a huge amount of information in the project can also be relevant in this case.

The two cases demonstrated on the one hand state of art FM system in operation, on the other hand however a digitalization in the sense of our framework are barely in motion.

The implication of our findings is to underline the importance of managerial, organizational and competence preparation when commencing on a path of digitalization of facilities management.

8. REFERENCES

- Atkin, B., Brooks, A. 2014, Total facility management, Fourth;4th; edn, John Wiley & Sons Inc, Southern Gate, Chichester, West Sussex, United Kingdom.
- Bilal, M., Oyedele, L.O., Qadir, J., Munir, K., Ajayi, S.O., Akinade, O.O., Owolabi, H.A., Alaka, H.A. & Pasha, M. 2016, Big Data in the construction industry: A review of present status, opportunities, and future trends, *Advanced Engineering Informatics*, 30, 500-521. doi: 10.1016/j.aei.2016.07.001.
- Clarke G 2016, Nearly all cloud ERP projects will 'fail' by 2018, reckons Gartner. Downloaded from https://www.theregister.co.uk/2016/03/02/postmodern_erp_disaster_gartner/

- Danske Regioner, 2011, Nye sygehusbyggerier: Det erhvervsmæssige potentiale. Danske Regioner, København
- Flyvbjerg B. and Budzier A. 2011, Why Your IT Project May Be Riskier Than You Think. Harvard Business Review, September, 23-25.
- Galer S. 2017, If You're Involved In Real Estate, You Need To Understand These 2 Innovations. Business #CuttingEdge Apr 12, 2017.
- Gartner 2016, Gartner's Top 10 Strategic Technology Trends for 2017. Gartner. Downloaded from <http://www.gartner.com/smarterwithgartner/gartners-top-10-technology-trends-2017/>.
- Gheisari, M. & Irizarry, J. 2016, "Investigating human and technological requirements for successful implementation of a BIM-based mobile augmented reality environment in facility management practices", Facilities, vol. 34, no. 1/2, pp. 69-84.
- Hastie, S. & Wojewoda, S. 2015, Standish Group 2015 Chaos Report - Q&A with Jennifer Lynch. <http://www.infoq.com/articles/standish-chaos-2015> 2016-03-01.
- Hågåy, T. 2013, Nye helsebygg for 73 milliarder på 10 år. Dagens medisin, <http://www.dagensmedisin.no>
- Landauer T.K. 1995, The trouble with computers: usefulness, usability and productivity, Cambridge, MIT Press.
- Madritsch, T. & May, M. 2009, "Successful IT implementation in facility management", Facilities, vol. 27, no. 11/12, pp. 429-444
- May M. 2013, Das CAFM-Handbuch. IT im Facility Management erfolgreich einsetzen.. Springer. Berlin.
- OECD 2013, Sweden 2013 Raising Standards. OECD Reviews of Health Care Quality. OECD.
- Sauer, C.; Willcocks, L. 2007, Unreasonable expectations - NHS IT, Greek choruses and the games institutions play around mega-programmes. Journal of Information Technology 22. 3 Sep 2007, 195-201.
- Standish Group 1995, Chaos Report, available at www.standishgroup.com/visitor/chaos.htm
- Standish Group 2000, Chaos University presentation, available at www.standishgroup.com/visitor/Events/presentations/im-johnson
- Teicholz, P.M., & IFMA Foundation 2013, BIM for facility managers, John Wiley & Sons, Inc, Hoboken, New Jersey.
- Volk, R., Stengel, J., Schultmann, F., 2014, Building Information Modeling (BIM) for existing buildings— literature review and future needs. Automation in Construction. 38, 109–127
- Whyte, J. 2011, Managing digital coordination of design: emerging hybrid practices in an institutionalized project setting, Engineering Project Organization Journal, vol. 1, no. 3, pp. 159-168
- WHO 2009, Investing in hospitals of the future. World Health Organization, Copenhagen.

IMPROVING FACILITIES TO REDUCE CARBON FOOTPRINT: THE CASE OF A COMMERCIAL BUILDING IN ASIA

J. H.K. Lai

Department of Building Services Engineering, The Hong Kong Polytechnic University, Hong Kong, China

Email: bejlai@polyu.edu.hk

Abstract: Facilities in buildings consume resources for their operations, thereby causing carbon emissions, which determine the carbon footprints of the buildings. In order to investigate the extent to which the carbon footprints could be reduced through improving the facilities in existing buildings, a research project has started. A review of the relevant literature found that carbon retrofits have been gaining attention around the world. The case study reported here was made on a typical commercial building in Hong Kong that comprises office and retail premises. After describing the methodology of the study, the sources and amounts of the building's carbon emissions are identified. Among the key findings are the dominance of electricity consumption in contributing to the overall carbon footprint. The improvement works made on the building's air-conditioning system saved as high as 46% of the original carbon emission and a carbon reduction of 28% was achieved by retrofitting the existing lighting. Despite the various difficulties encountered during the research process, the experience and result of this study provide a useful basis for pursuing further empirical studies on carbon reduction efficiency and implementation priorities of different improvement works for existing facilities.

Keywords: Carbon, Electricity, Energy, Facilities, Greenhouse Gas

1. INTRODUCTION

Greenhouse gas emissions (or carbon emissions) have continued to increase across the globe. Energy-intensive metropolises, particularly those in Asia (e.g. Hong Kong) with a subtropical climate, produce a great deal of carbon emissions. Following the Intergovernmental Panel on Climate Change's method of calculation, the carbon emissions of Hong Kong were found to have significantly increased - from 33.3 million tonnes CO₂-e in 1990 to 43.1 million tonnes CO₂-e in 2012 ([Environment Bureau, 2015](#)). Electricity generation, which is the largest source of carbon emissions in the city, accounts for about 68% of the total emissions.

Crowded with numerous high-rise commercial buildings, Hong Kong is both a financial hub and a tourist city. Its private commercial premises, comprising retail premises and other premises designed or adapted for commercial use, amounted to 10,992,400 m². The total stock of private office premises was 11,283,200 m² ([Rating and Valuation Department, 2016](#)). Facilities in the commercial buildings, including air-conditioning systems, lighting, lifts, escalators and so on, are essential to the operations of the buildings. All such facilities consume energy, thereby causing carbon emissions. For facilities without proper operation and maintenance, inefficient energy use will aggravate the carbon emission problem. If improvement works are implemented for deteriorated facilities, on the contrary, less energy will be used, minimizing the carbon footprints of the buildings.

In order to identify the carbon footprints of commercial buildings and investigate the effectiveness of reducing the footprints through improving the facilities of the buildings, a research project has started. A case study on a typical commercial building in Hong Kong, being part of the project, is reported in this paper. Shown in the next section (Section 2) is a review of the past research works, especially those case studies that are relevant to the present

study. Section 3 describes the methodology of the study, including how the needed data were collected and how the carbon emissions of the building were calculated. Section 4 covers not only the calculated emissions but also discussions on the reduction of carbon footprints resultant from implementing improvement works for the building. Finally, Section 5 provides a summary of the conclusions drawn from the study and the works ahead.

2. LITERATURE

A review of the relevant literature found that there were case studies on building retrofit. The main issues they covered, including those in the technical, financial, policy and social aspects, are highlighted as follows.

2.1 Technical and financial issues

[Dequaire \(2013\)](#) carried out a multiple-case study of four school retrofits in Austria. Constructed in the same period (1961-1977) with similar constructions, the school buildings were retrofitted in the same period (2007-2009). The study highlighted that large retrofitted buildings, such as schools, have more than 80% reduction in heat demand when compared with the traditionally planned refurbishments. The buildings also achieved the energy efficiency level of Passivhaus standard for new buildings. The results show that the Passivhaus approach to the renovation of large buildings is reliable for improving energy efficiency of large buildings.

In Hong Kong, [Sun & Lau \(2015\)](#) made use of the retrofitting project at the Chow Yei Ching Building of the University of Hong Kong to study the process of retrofits and energy audit for an existing building. Built in 1993 and with a total floor area of around 13,168 m², the building is a multipurpose, 13-storey building comprising offices, lecturer rooms and laboratories. Aimed at achieving 30% energy savings, the energy service company proposed a range of facility improvement measures, including: chilled water plant upgrading and optimization, building management system upgrading and with energy monitor and controlling, lighting retrofits, window film, solar panel, etc. Computer simulations were made to evaluate how much energy can be saved by adopting the retrofits. After the retrofits, the study team would conduct 1-year testing to verify the simulated energy savings.

In the UK, [Gupta & Gregg \(2016\)](#) adopted a socio-technical building performance evaluation approach to assess the actual performances before and after the implementation of two discrete deep low energy retrofits. The results showed that the post-retrofit, which was a Victorian house, could achieve nearly 75% carbon reduction, while the counterpart of the modern house was reduced by 57%. In both cases, occupants' satisfaction and comfort were greatly improved. However, the significant difference between the modelled and actual carbon emissions of the retrofits underlined the need to calibrate energy models with real energy and environmental performance data.

The case study of [Oree et al. \(2016\)](#) was conducted on the 10-storey Emmanuel Anquetil building in Mauritius. Owned and maintained by the government, the building was constructed in 1979. Without structural development in its 35 years of operation, the building was considered representative as a worst-case scenario in energy efficient building design. The potential of retrofitting the building was reviewed through energy audit, simulation software

and Integrated Environmental Solutions – Virtual Environment, and validations were made by comparing the actual result with the simulated one. It was found that among the three retrofit measures, namely using double glazing, applying inner insulation and using energy efficient luminaires, replacing all T8 light tubes with T5 tubes achieved the most energy saving and it corresponds to 5.52% decrease in the actual building scenario. This retrofit measure, as compared with the other two, has a shorter payback period.

Besides the above study (Oree et al., 2016) where financial analyses were carried out on the selected retrofit measures, a multifamily retrofit building located in Matosinhos of Portugal was analysed by Ferreira et al. (2014) to identify the most cost-effective solution for achieving net-zero energy targets. Different combinations of retrofit packages, including replacement of damaged tiles, installing building-integrated technical systems for domestic hot water, providing heating and cooling for restoring building functionality, were considered. The results indicated no major difficulties for the transition between ‘cost optimality’ and ‘nearly zero-energy buildings’.

2.2 Policy and social issues

In order to limit the global temperature rise to as little as possible above 2⁰C, the UK government has committed to reducing carbon emission (Committee on Climate Change, 2017). Applying three multiple post occupancy evaluation protocols, namely the Building Research Establishment Environmental Assessment Method (BREEAM) “in-use”, the Soft Landings approach and the Design Quality Method, Atkins and Emmanuel (2014) studied their suitability in meeting the UK’s climate change reduction target: 80% reduction in carbon emission by 2050 over the 1990 levels. It was found that if the building stock is refurbished at nearly 2.5% of its floor space per year, more than half of the energy used by the stock could be reduced.

Through analysing the questionnaire data of 130 social housing providers in the UK, Swan et al. (2013) revealed that the providers were aware of the sustainable retrofit agenda, but with different levels of strategic readiness. The providers regarded the emerging nature of the sustainable retrofit market as the major risk for adoption. Market-making, as the authors remarked, should not be pursued at the risk of the residents’ health or financial well-being.

The above review shows that carbon retrofits have attracted increasing attention around the world. Many of the past studies focus on housing or government buildings. In-depth studies taking a longitudinal approach to investigate changes in carbon emissions resultant from retrofitting facilities in private commercial buildings, especially those high-rise buildings in the subtropical places of Asia (e.g. Hong Kong), remain to be seen.

3. METHODOLOGY

3.1 Data collection

To gather data on improvement works carried out for commercial buildings in Hong Kong, an online survey was conducted. The survey questionnaire was distributed to facilities management (FM) practitioners who look after existing commercial buildings and the respondents were asked to provide data about the characteristics of their buildings and what

kinds of improvement works had been implemented. The respondents were also asked to indicate if they would like to participate in a further part of the study where the carbon emissions of their buildings are audited and analysed in detail.

After the survey, the study team contacted those who had indicated their interest in joining the carbon audit. To investigate the carbon emissions of their buildings and changes in the emissions associated with any improvement works implemented, data spanning a reporting period of five years were collected. For this purpose, a meeting was held during which the study team explained to each participant the data needed for the audit. A set of electronic templates, which was devised for collecting the data, was also provided to the participants.

In line with the Greenhouse Gas Protocol, quantifications of carbon emissions under the study were made for three scopes of emissions/removals. They include: Scope 1 - direct emissions/removals (due to stationary sources combustion, mobile sources combustion, fugitive emissions, and assimilation of carbon dioxide into biomass); Scope 2 - energy indirect emissions (due to consumption of purchased electricity, consumption of town gas); and Scope 3 - other indirect emissions (due to methane gas generation at landfill resulting from disposal of paper waste, consumption of fresh water, treatment of waste water, and business travel by employees). Information about improvement works for heating, ventilation and air-conditioning (HVAC), lighting, lifts, escalators, and plumbing and drainage installations was also collected.

The first part of the templates was designed to collect data about the physical and operational characteristics of the participating buildings, including their age, total number of floors, construction floor area, internal floor area, number of FM staff, power supply for the air-conditioning system, and improvement works implemented. [Table 1](#) summarises the key characteristics of the building selected for detailed analysis in the current case study.

Table 1. Key characteristics of the building

Age of building:	25 years
Total no. of floors: (including basement floors)	21
Internal floor area:	~ 21,000 m ²
Number of FM staff:	Technical: 8; Management: 8
Provisions for air-conditioning (fan coil units) in tenant areas:	Chilled water supply by landlord; electricity supply by tenants.

The remaining parts of the templates solicit monthly data of the following items: 1) diesel oil consumption (e.g. for emergency power generation); 2) amount of fuels consumed by mobile combustion sources (e.g. transport service for guests); 3) local and overseas travelling records for management office staff; 4) inventory levels of refrigerants and amounts of refrigerants added and removed; 5) quantity and height of trees planted or removed; 6) electricity consumptions and metered readings of electricity used; 7) town gas consumptions and metered readings of town gas used; 8) inventory levels of paper and amounts of paper used and collected for recycling; and 9) water consumptions and metered readings of fresh water used.

3.2 Calculation of carbon emission

The collected data were processed following the “Guidelines to Account for and Report on Greenhouse Gas Emissions and Removals for Buildings (Commercial, Residential or Institutional Purposes)” (Environmental Protection Department and Electrical and Mechanical Services Department, 2010). Supplementary information required for computing the carbon emissions (e.g. emission factor of electricity generation) was retrieved from published booklets and websites of the respective relevant power company.

With reference to the procedure for computing carbon emissions in the study of Lai (2015), the amount of carbon emission due to combustion of fuel at the building (Scope 1 direct emission), was obtained using Eq. (1).

$$E_A^C = \sum_{f=1}^{f=F} \sum_{t=1}^{t=T} A_{f,t} \times F_{(f)A} \times G_{(A)} \quad (1)$$

where

- E_A^C = gas A emission due to fuel combustion (tonnes CO₂-equivalent); gas A can be CO₂, CH₄ or N₂O
- $A_{f,t}$ = amount of fuel f consumed (litre) in the tth period
- $F_{(f)A}$ = emission factor of gas A for fuel f
- $G_{(A)}$ = global warming potential of gas A

For emissions due to consumption of electricity purchased from the power company (i.e. energy indirect emissions in Scope 2), they were calculated using Eq. (2).

$$E_{GHG}^E = \sum_{t=1}^{t=T} A_{(E)t} \times F_{(E)t} \quad (2)$$

where

- $A_{(E)t}$ = amount of electricity used (kWh) in the tth period
- E_{GHG}^E = carbon emission (kg CO₂-e) due to the use of purchased electricity
- $F_{(E)t}$ = emission factor (kg CO₂-e/kWh) of electricity used in the tth period, which varies with power company and year (China Light and Power, 2011; 2015)

Other indirect emissions are in Scope 3. This group of carbon emissions, including those due to paper waste disposed at landfills and electricity used for fresh water supplies and sewage processing, were computed using Eq. (3) and Eq. (4).

$$E_{GHG}^P = (Ps + Pi - Pc - Pe) \times F_{(P)} \quad (3)$$

where

- E_{GHG}^P = carbon emission (kg CO₂-e) due to paper waste disposed at landfills
- $F_{(P)}$ = emission factor of paper used (estimated at 4.8 kg CO₂-e/kg)
- P_s = paper inventory at the beginning of the reporting period (kg)

- P_i = paper added to the inventory during the reporting period (kg)
 P_c = paper collected for recycling purpose (kg)
 P_e = paper inventory at the end of the reporting period (kg)

As there were no inventory records of paper, the inventory levels at the beginning and at the end of the reporting period were assumed to be the same, i.e. $P_s = P_e$.

Using Eq. (4), the amounts of carbon emissions due to consumption of fresh water and treatment of sewage were obtained. $F_{(W)}$ or $F_{(D)}$ were determined in two steps: first, the relevant figures on power consumption for water supply and sewage treatment were retrieved from the reports of WSD and DSD ([Drainage Services Department, 2014; 2015](#); [Water Supplies Department, 2012; 2015](#)); second, the unit power consumption figures were multiplied by the territory-wide default value of purchased electricity (0.7kg/kWh).

$$E_{GHG}^{SS} = A_{(W)} \times (F_{(W)} + F_{(D)}) \quad (4)$$

where

- $A_{(W)}$ = amount of water consumed (m^3)
 E_{GHG}^{SS} = carbon emission due to electricity used for processing fresh water and sewage by the Water Supplies Department (WSD) and Drainage Services Department (DSD)
 $F_{(W)}$ = emission factor of processing fresh water ($kg\ CO_2-e/m^3$)
 $F_{(D)}$ = emission factor of processing sewage ($kg\ CO_2-e/m^3$)

Since records of business travels were not made available by the building's management company, the corresponding amounts of carbon emissions could not be determined.

4. RESULTS AND DISCUSSION

4.1 Sources and amounts of carbon emissions

The calculated amounts of carbon emissions due to the consumptions of various resources over the 5-year reporting period are summarized in [Table 2](#). In 2013 and 2015, there were no emissions due to the use of emergency power generator (i.e. consumption of diesel oil for regular tests or occasional emergency power supplies ([Lai et al., 2012](#))) because no diesel oil was purchased for replenishment during those periods. Overall, the majority of the emissions were due to the use of electricity purchased from the power company; they range between 1,250.7 tonnes CO_2-e (94.0%) and 2,140.7 tonnes CO_2-e (97.6%). Therefore, reducing the energy consumption of electrical equipment would significantly reduce the carbon emission of the building.

The amounts of carbon emissions due to the use of other resources, including paper and electricity for water supply and processing sewage, were small when compared with the counterpart due to the consumption of purchased electricity. Note that the negative amounts of carbon emissions due to paper for cycling were obtained because the volume of paper collected for recycling, which lumped together paper used for general purposes and paper/cartons used for goods packaging, exceeded the volume of paper purchased.

Table 2. Summary of carbon emissions of the building

Emission (kg CO ₂ -e)	2011	2012	2013	2014	2015
Emergency power generation (on-site)	283	189	-	565	-
Electricity (purchased)	2,002,801	1,979,281	2,140,745	2,047,683	1,250,726
Paper consumption	65,731	45,458	48,494	59,228	71,694
Paper for recycling*	-517,680	-463,728	-293,520	-207,936	-186,336
Electricity used for water supply and processing sewage	4,739	4,874	4,622	3,751	7,783
Total:	2,073,554	2,029,802	2,193,760	2,111,227	1,330,203

*Note: The amount of paper collected for recycling, which is more than that of paper purchased, was omitted in determining the total amount of carbon emission. Negative value represents removal of carbon emission.

Figure 1 shows the trend of the yearly carbon emissions of the building. There were no substantial changes in the emissions from 2011 to 2014 (between 2029.8 and 2111.2 tonnes CO₂-e per year); the emission slightly decreased from 2011 to 2012, followed by a rise in 2013 and then a mild decline in 2014. The peak emission, 2193.8 tonnes CO₂-e, occurred in 2013. In 2015, the annual carbon emission drastically dropped to 1,330.2 tonnes CO₂-e, which is about 60% of the peak.

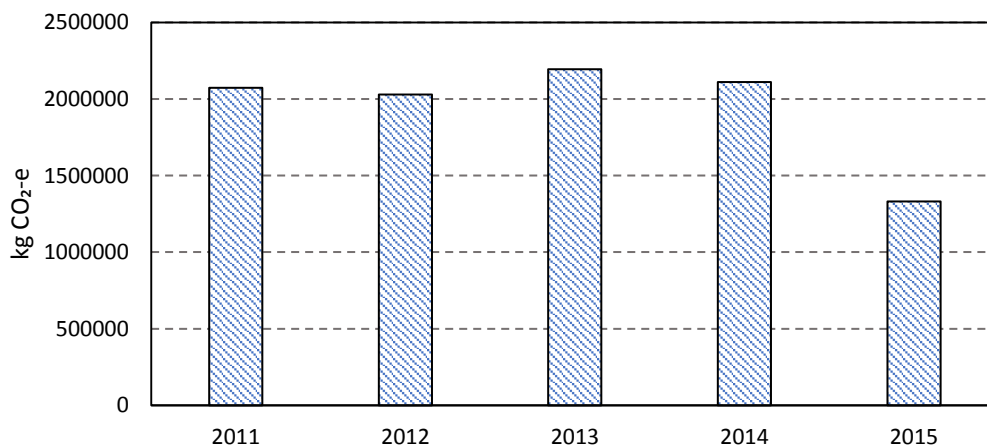

Figure 1. Total yearly carbon emissions of the building

According to the information collected from the building's management company, some improvement works, including installation of an automatic tube cleaning system for chillers, adoption of fresh water cooling and use of a centralized control and monitoring system (CCMS), were implemented for the building. The lighting system of the building was improved by replacing the existing lamps with energy efficient lamps (e.g. incandescent lamps were replaced with compact fluorescent lamps, and T12/T10 fluorescent tubes were replaced with T5 tubes). The effects of these works on the electricity consumption and carbon emissions of the building are analysed in the ensuing section.

4.2 Improvement works and carbon reductions

The improvement works for the building's air-conditioning system, including their start and finish dates, the meters involved in monitoring the electricity consumptions of the relevant

parts of the system, and the electricity consumptions and carbon emissions before and after implementation of the improvement works, are summarised in [Table 3](#).

Table 3. Improvement works for the air-conditioning system

Improvement works	Start	Finish	Meter involved
1. Install automatic tube cleaning system for chillers	02/02/2015	04/11/2015	Meter 2: Central HVAC Power (for Chiller Nos. 3 & 4) Meter 3: Central HVAC Power (for Chiller Nos. 1 & 2)
2. Adopt fresh water cooling	02/02/2015	04/11/2015	Meters 2 and 3
3. Use of a CCMS	02/02/2015	04/11/2015	Meters 2 and 3
	Electricity consumption (kWh)	Carbon emission (kg CO₂-e)	
Before improvement	118,364	75,753	
After improvement	75,443	40,739	
Change	-42,921 (-36%)	-35,014 (-46%)	

Consequent to the air-conditioning improvement works, the electricity consumption decreased greatly from 118,364 kWh to 75,443 kWh, representing 36% reduction in energy use. In the same period, the carbon emission was reduced to 40,739 kg, i.e. a big drop of 46%. The percentage changes in electricity consumption and carbon emission are different because the annual emission factor of electricity varies with the contents of fuels used by the power company over the 5-year period.

Table 4. Improvement work for the lighting system

Improvement work	Start	Finish	Meter involved
4. Replace the existing lamps with energy efficient lamps that provide similar illumination levels	1/1/2011	31/12/2015	Meter 1: Public Area (General)
	Electricity consumption (kWh)	Carbon emission (kg CO₂-e)	
Before improvement	55,335	32,648	
After improvement	43,621	23,555	
Change	-11,714 (-21%)	-9,093 (-28%)	

For the lighting improvement work ([Table 4](#)), which was implemented in phases over a period of five years, the resultant reduction in electricity consumption is significant: from 55,335 kWh to 43,621 kWh. This is equivalent to 21% energy saving, or 28% carbon reduction.

4.3 Difficulties encountered and measures taken

The research process of the study was not straightforward. The first difficulty encountered was the lack of the data required for carrying out a complete carbon audit. In the absence of paper inventory records, only the amounts of paper purchased and collected for recycling were taken to calculate the carbon emissions due to the use of paper. Yet, the practice of recording the amount of paper collected for recycling made it infeasible to single out the amount of paper/cartons used for goods packaging, while the latter far outweighed the amount of paper used for general purposes.

The unavailability of business travel data was another difficulty that rendered the carbon audit incomplete. Notwithstanding this limitation, the amount of carbon emission due to business travel, even in some typical hotels with a large number of staff members, contributes to only a tiny portion (Lai, 2015).

A further difficulty ascribes to the set-up of the energy meters. With multiple improvement works implemented during the reporting period, the amount of energy saving and hence the amount of carbon reduction resulted from the individual works could not be identified precisely unless there were dedicated sub-meters recording the corresponding changes in electricity consumptions. To determine such changes while minimizing errors arising from the effect of climatic changes on energy consumption (e.g. for air-conditioning system), the energy saving was calculated by comparing the difference between the electricity consumption of the month immediately after completion of each improvement work (e.g. Dec 2015) and the counterpart of the same month in the preceding year where the work was not yet commenced (e.g. Dec 2014). In this same way, the change in carbon emission resultant from the improvement work for the lighting system was determined.

5. CONCLUSIONS

Empirical case studies on carbon footprints of buildings, especially those taking a longitudinal approach to unveil carbon reductions resultant from improving the existing facilities of commercial buildings in subtropical areas of Asia, are not available. Intended to contribute knowledge to this area, the study reported above, with a typical commercial building in Hong Kong taken as the study object, was carried out.

Detailed monthly data over a period of five years, which cover a wide range of resources consumptions under Scopes 1, 2 and 3 of the Greenhouse Gas Protocol, were collected to identify the sources and amounts of carbon emissions. Electricity consumption was the dominant source of carbon emission of the building. This shows that in order to reduce carbon emissions, effort should be concentrated on minimizing the use of electricity.

The comparisons between the carbon emissions before and after the improvement works were implemented revealed that the works on the air-conditioning system, namely installing an automatic tube cleaning system for the chillers, adoption of fresh water cooling and use of a CCMS, substantially reduced the emissions. The emissions cut after the lighting improvement work, though comparatively smaller, is significant.

Built upon the experience and result of this study, more in-depth case studies will be carried out to investigate the sizes of carbon footprint that can be reduced by improving different types

of facilities in buildings. As FM budgets are often limited (Lai, 2010), it is also necessary to identify the cost-effectiveness of different types of improvement works and hence the priority order for their implementation in existing buildings.

6. ACKNOWLEDGMENT

The study described in this paper was supported by a grant from the Research Grants Council of the Hong Kong Special Administrative Region, China (Project No. PolyU 152095/15E).

7. REFERENCES

- Atkins, R. & Emmanuel, R. (2014), *Could refurbishment of “traditional” buildings reduce carbon emissions?*, Built Environment Project and Asset Management, 4(3), 221-237.
- China Light and Power (2011), 2011 *Sustainability Report*, Hong Kong.
- China Light and Power (2015), 2015 *Sustainability Report*, Hong Kong.
- Committee on Climate Change (2017), Carbon budgets: how we monitor emissions targets [online] Available at: <https://www.theccc.org.uk/tackling-climate-change/reducing-carbon-emissions/carbon-budgets-and-targets/> [Accessed 6 April, 2017]
- Dequaire, X. (2015), *A Multiple-Case Study of Passive House Retrofits of School Buildings in Austria*, In: Torgal, F, P., Mistreeta, M., Kaklauskas, A., Granqvist, C, G. & Cabeza, L, F., eds., *Nearly Zero Energy Building Refurbishment*, 1st ed. Springer London, 253-278, DOI: 10.1007/978-1-4471-5523-2_10
- Drainage Services Department (2014), *Sustainability Report 2013-14*, Hong Kong Government.
- Drainage Services Department (2015), *Sustainability Report 2014-15*, Hong Kong Government.
- Environment Bureau (2015), *Hong Kong Climate Change Report*, Hong Kong Government. [online] Available at: <http://www.enb.gov.hk/sites/default/files/pdf/ClimateChangeEng.pdf> [Accessed 3 April, 2017]
- Environmental Protection Department and Electrical and Mechanical Services Department (2010), *Guidelines to Account for and Report on Greenhouse Gas Emissions and Removals for Buildings (Commercial, Residential or Institutional Purposes) in Hong Kong*, Hong Kong Government.
- Ferreira, M., Almeida, M., Rodrigues, A. & Silva, S, M. (2014), *Comparing cost-optimal and net-zero energy targets in building retrofit*, Building Research & Information, 44(2), 188-201.
- Gupta, R., & Gregg, M. (2016), *Do deep low carbon domestic retrofits actually work?*, Energy and Buildings, 129, 330-343.
- Lai, J.H.K. (2010), *Operation and maintenance budgeting for commercial buildings in Hong Kong*, Construction Management and Economics, 28(April), 415-427.
- Lai, J.H.K., Yik, F.W.H. & C.S. Man (2012), *Carbon Audit: A Literature Review and an Empirical Study on a Hotel*, Facilities, 30(9), 417-431.
- Lai, J.H.K. (2015), *Carbon footprints of hotels: Analysis of three archetypes in Hong Kong*, Sustainable Cities and Society, 14, 334-341.
- Oree, V., Khoodaruth, A. & Teemul, H. (2016), *A case study for the evaluation of realistic energy retrofit strategies for public office buildings in the Southern Hemisphere*, Build Simulation, 9, 113–125.
- Rating and Valuation Department (2016), *Hong Kong Property Review 2016*, Hong Kong Government. [online] Available at: http://www.rvd.gov.hk/doc/en/hkpr16/PR2016_full.pdf [Accessed 3 April, 2017]
- Sun, X. & Lau S.Y.S. (2015), *Existing buildings’ operation and maintenance: renovation project of Chow Yei Ching Building at the University of Hong Kong*, International Journal of Low-Carbon Technologies, 10, 393–404.
- Swan, W., Ruddock, L. & Smith, L. (2013), *Low carbon retrofit: attitudes and readiness within the social housing sector*, Engineering, Construction and Architectural Management, 20(5), 522-535.
- Water Supplies Department (2012), *2011/12 Annual Report*, Hong Kong Government.
- Water Supplies Department (2015), *2014/15 Annual Report*, Hong Kong Government.

KEY PERFORMANCE INDICATORS FOR FACILITY PERFORMANCE ASSESSMENT: MEASURING CORE INDICATORS USING BUILDING INFORMATION MODELING

S. Lavy and M. K. Dixit

Department of Construction Science, Texas A&M University, 3137 TAMU, College Station, TX 77843-3137, United States of America

Email: slavy@arch.tamu.edu

Abstract: Facility performance measurement, which refers to assessing the physical assets and their performance, is a major component of Facility Management. While there are different approaches for such purpose, Key Performance Indicators (KPI) are intensively studied and utilized by facility managers and scholars. This study is focused on four core KPIs, namely Maintenance efficiency indicator (MEI), Replacement efficiency indicator (REI), Condition index (CI), and Functional index (FI). Building Information Model (BIM), as an object-oriented 3-dimensional representation, contains data related to the building. Also, some BIM applications, such as Autodesk Revit, provide a platform for automation through their Application Programming Interface (API). The embedded data along with visualization and automation features of BIM can be utilized to automatically simulate and track core KPIs of a facility. This study builds on previous research and focuses on the opportunity to automate the process of simulating core KPIs by benefiting from the advantages of BIM. In this paper, we demonstrate the integration of a generic FM function into a BIM platform, Autodesk Revit and develop a BIM prototype. The prototype demonstrates an outstanding opportunity to develop tools that help facility managers track the performance of facilities using a BIM platform.

Keywords: Assessment, Building Information Modeling, Computer Applications, Facility Management, Key Performance Indicators.

1. INTRODUCTION

The physical, functional, and financial performance of the built environment is an important aspect of facility management. As a result, the measurement of performance has also been a significant topic of study in the facility management literature and research. Different approaches exist as to the implementation of performance measurement, and among them are Key Performance Indicators (KPIs). This study focuses on the measurement of four KPIs, namely Maintenance efficiency indicator (MEI), Replacement efficiency indicator (REI), Condition index (CI), and Functional index (FI).

Building Information Modeling (BIM) is referred to a system containing all the data related to a building (Sabahi, 2010). This data should range from the early planning and design phases, through construction drawings and specifications, all the way to as-builts and catalog data for the various systems, components, and pieces that exist within a building. This data, in addition to the visualization capabilities that BIM may be able to offer, can be utilized to automatically simulate and track the core KPIs of a facility along the building's service life.

This study builds on the research conducted by Lavy *et al.* (2014a; 2014b; 2014c) and focuses on the opportunity to automate the process of simulating core KPIs by benefiting from advantages of BIM. It is used as an opportunity to develop tools that help facility managers to track the performance of facilities in a BIM platform, which forms the basis of the current study.

2. LITERATURE REVIEW

2.1. Facility performance measurement

Performance measurement, in the context of facility management, is the process of reviewing past and current functioning of a facility, comparing the performance within and among the facilities, to provide direction for decision-making (Lavy *et al.*, 2014a). Performance measurement is essential to perform comparisons and develop strategies for improvement and it should support informed decision making about the allocation of resources within and by an organization (Cable and Davis, 2004).

The physical environment of any organization can highly affect the efficiency of that organization (Amaratunga *et al.*, 2000a). Performance measurement is essential to assess the efficiency and effectiveness of a facility (Lavy *et al.*, 2010). It provides the necessary input for an organization to assess how well it is progressing towards its objectives in the facility management context (Lai and Choi, 2015).

2.2. Performance measurement using KPIs

The most common facility performance measurement approaches are benchmarking, balanced scorecard, post occupancy evaluation (POE) and key performance indicators (KPI) (Amaratunga *et al.*, 2000b; Lavy *et al.*, 2014a; Lavy *et al.*, 2014c). There is an emphasis on the KPI method (Lavy *et al.*, 2014c) mainly because it enables the management team to establish effective evaluation metrics (Lavy *et al.*, 2010).

Lavy *et al.* (2010) conducted a literature-based study coupled with a short survey filled out by the facility management professionals and classify the KPIs into four categories of financial, physical, functional, and survey-based. They identified a list of 35 major indicators that covers the facility performance assessment.

After developing a concise and comprehensive list of indicators, Lavy *et al.* (2014b) put an effort to derive proper mathematical expressions for these core indicators to make them quantifiable and measurable. Lavy *et al.* (2014b) developed the following four quantifiable indicators that relate to a facility's condition, functional performance, maintenance efficiency, and replacement efficiency:

Condition index (CI). A condition index reflects the physical condition of a system or facility. Condition index (CI) can be represented by a ratio of maintenance deficiency to the current replacement value (CRV) of the facility or system. CRV is the total cost required to restore a facility or system to a condition of "as good as new" with maintaining the same functional capacity. Maintenance deficiency, also known as deferred maintenance (DM), is any maintenance activity that needed to be done but was deferred due to some reason. This is usually measured by the amount of dollars of maintenance work that has been deferred. Because the decisions to defer a maintenance task are taken in-house, the DM can be tracked within the organization even though its FM services are outsourced or contracted. Hence:

$$CI = \frac{\text{Maintenance deficiency}}{\text{Current replacement value}} = \frac{DM}{CRV}$$

Maintenance efficiency indicator (MEI). This indicator reflects the maintenance performance of a facility. An MEI is defined as the ratio of maintenance expenditure to a facility's CI (Lavy *et al.*, 2014c). Maintenance expenditure or the amount spent on deferred maintenance is represented by the spending percentage on deferred maintenance (SDM) and is calculated as a ratio of actual to targeted deferred maintenance by Lavy *et al.* (2014b). Hence:

$$\text{MEI} = \frac{\text{SDM}}{\text{CI}} \times 100$$

$$\text{SDM} = \frac{\text{DM (Actual)}}{\text{DM (Targeted)}} \times 100$$

Replacement efficiency indicator (REI). This indicator reflects the replacement efficiency of a facility and is based on comparing the total replacement expenditure against the total cost of all expired systems in a given year (Lavy *et al.*, 2014b). The expired systems are those whose service life has ended and that require to be replaced. Hence:

$$\text{REI} = \frac{\sum \text{Cap. R}}{\sum \text{Exp.}} \times 100$$

Functional index (FI). This indicator reflects the suitability of a facility for the intended use and mainly depends on sufficient space as well as effective space management (Lavy *et al.*, 2014c). Lavy *et al.* (2014b) proposes the following formula to calculate FI:

$$\text{FI} = \frac{\text{Total area of specific space type (Actual)}}{\text{Total area of specific space type (Required)}}$$

2.3. Building Information Modeling in Facility Management

There is a tendency in the facility management industry to utilize new opportunities such as BIM to gain advantage of potential benefits. Implementation of BIM in the operation and maintenance phase has been studied for the purposes of planning maintenance activities (Akcemete *et al.*, 2010), extracting useful information needed by facility managers (Anoop *et al.*, 2011), developing facility management data models (Yu *et al.*, 2000), developing design guidelines for maintenance accessibility (Liu and Issa, 2014).

Also, BIM-based automation tools have been developed for operation and maintenance activities such as fault detection in HVAC systems (Golabchi *et al.*, 2016). Golabchi *et al.* (2016) developed a BIM plug-in that guides the HVAC repair operations by localizing those HVAC components that are most likely at fault.

In other phases of a building's lifecycle including design and construction, BIM has been widely used to automate processes that lead to better decision-making. Zhang *et al.* (2012) developed an automatic safety checking application based on BIM. Jahangiri (2016) developed a BIM-based optimization tool to generate drywall cutting layouts automatically.

3. RESEARCH QUESTION AND OBJECTIVES

This study investigates if measuring the proposed core KPIs can be performed on a Building Information Modeling platform, so that automation and visualization benefits of BIM can be realized in tracking facility performance.

The objective of this study is to take a step for practical implementation of BIM in facility management by:

- a) Developing a BIM-based plug-in application to automatically measure core KPIs using the embedded data and user inputs.
- b) Testing the developed application on actual buildings to study the relationships between input variables, BIM data and KPIs

The following assumptions were considered throughout this study:

- a) The add-in application was developed in Autodesk Revit platform.
- b) Case studies used for testing the performance of the application are simple Building Information Models.
- c) The input data regarding facility's performance is not actual real data.
- d) The method of area measurement in this study is based on the Gross Area Measurement Standard procedure set by BOMA International (ANSI/BOMA Z65.3 – 2009).

4. RESEARCH METHODS

4.1. Developing the plug-in

The initial step in this study is to develop a BIM-based plug-in application that measures KPIs using extracted data from both the BIM model and a calculation program such as a spreadsheet in MS Excel. In other words, the plug-in is supposed to automate a process. This is performed by implementing an algorithm using Revit Application Programming Interface (API). We developed a test spreadsheet that has the formula set up for the KPIs' calculation. This spreadsheet represents any type of calculation or any other software an organization may be using for assessing its facilities' performance.

Using Revit API, which allows to program with languages such as C#, it is possible to gain access to all the embedded data in the model, analyze and edit the data and also present the outcome. In other words, it enables us to create add-ins to automate processes.

The algorithm is broken down to three stages. First it needs to extract geometrical data from the BIM model including the floor plan areas to measure KPIs such as Functional Index (Figure 1).

In general, there are different methods of area measurement depending on occupancy type or building size. The Building Owners and Managers Association (BOMA), which represents the owners and managers of all commercial property types, is a primary source of information on building management and operations. BOMA International is considered as a leader in setting proper standards for building measurements and has developed a standard to measure floor areas, which has a widespread use in the industry.

According to BOMA (2009), Gross Area measurement method can be applied for all the floor levels of a building to determine the required areas that benefit occupants. This method of area measurement is uniform basis and can be applied to all building types to measure the exterior gross area. Therefore, the application is designed to extract the actual gross area of the building from the model.

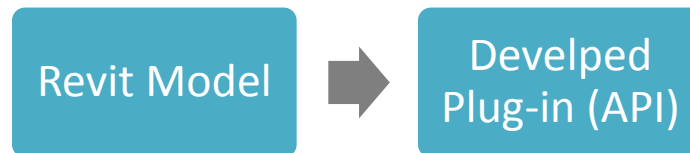

Figure 3: Revit model feeds the plug-in with geometric data

In the second stage, the plug-in application retrieves other required data from an Excel spreadsheet (Figure 2). Although the data can be entered manually in the Revit environment, it is assumed that it is saved in an Excel spreadsheet which is a common practice in facility management industry for the purposes of tracking and recording the building performance. Table 1 shows the data that the plug-in application extracts from the Excel file.

Table 3: Required data available in Excel spreadsheet

1	Current Replacement Value	CRV
2	Actual Deferred Maintenance	DM(A)
3	Targeted Deferred Maintenance	DM(T)
4	Total Replacement Expenditure	Cap. R.
5	Total Cost Of All Expired Systems	Exp.
6	Total Required Area	Req. A.

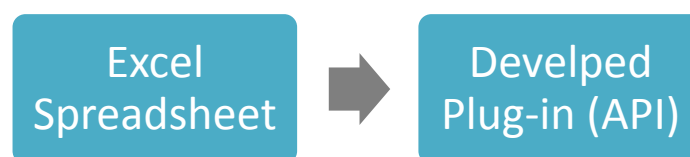

Figure 4: Excel spreadsheet feeds the plug-in with cost data

The third stage of algorithm is aimed to calculate the values of core KPIs. Lavy *et al.* (2014b), after developing a concise and comprehensive list of indicators, derived mathematical expressions for the core indicators to make them quantifiable and measurable (Figure 3). This stage is based on those mathematical expressions as well as the correlations between core KPIs.

After developing the plug in, the next phase is to test the application on a BIM Model to investigate if it is generating the right values (Figure 3). Also, the outputs can be studied to find out the relationships between input variables, BIM data and KPIs.

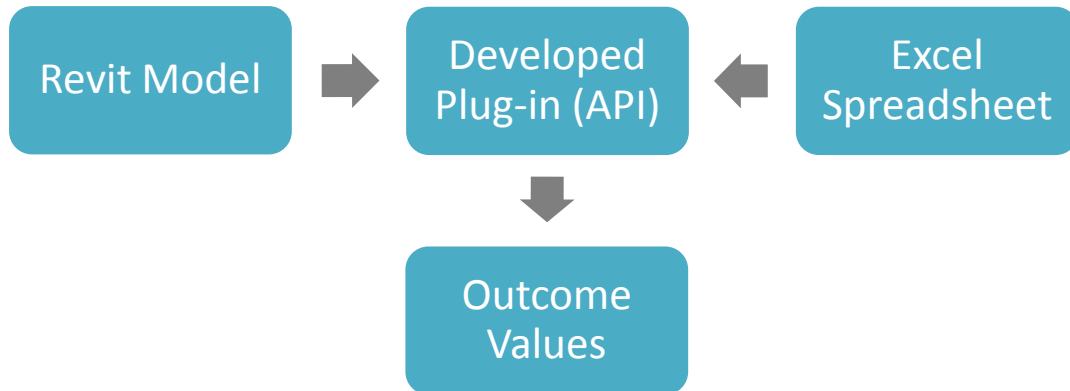

Figure 5: Plug-in retrieves and processes input data to generate outcome

4.2. Testing the plug-in

It is necessary to test the plug-in application and evaluate its performance. The focus of the study is to develop a BIM-based plug-in that automates the measurement of core KPIs. Therefore, the main goal in this stage is to observe the performance of the application while being fed with various input data (Figure 4).

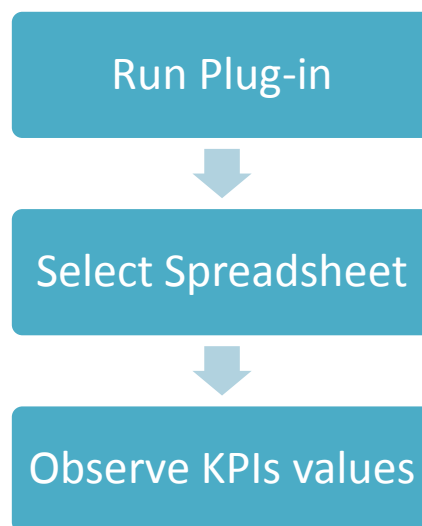

Figure 4: Steps to test the plug-in

Ten tests were carried out to observe the performance of the plug-in. All tests were carried out on the same BIM model. Other input values were set in such way that the performance of the plug-in can be observed and analyzed and the relationship between input data and output value can be examined. Figure 5 illustrates a sample run of the plug-in through a screen captures from Autodesk Revit.

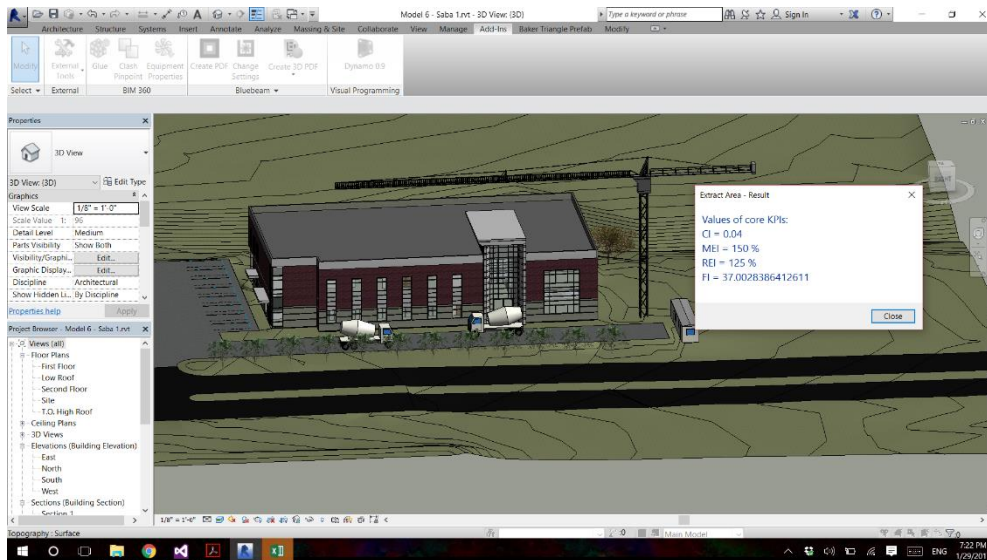

Figure 5: A screen capture of the plug-in run in Autodesk Revit

The analysis may be performed using actual data or it may be based on reasonable assumptions. In this study, the input values are not actual data. The data used for analysis is simply assumed based on the definitions and within the reasonable range.

5. OUTCOME AND DISCUSSION

5.1. Calculated values of core KPIs

For each test, the plug-in is fed with an Excel spreadsheet containing a set of input data. The input data is not actual data relating to any specific building but it is basically simulated data based on reasonable assumptions. The main assumption is that the relative values of the input data is more important than the absolute values in order to observe the performance of the plug-in and to examine the output values. We successfully ran ten tests to experiment with the plug-in. Table 2 lists input data and the results of the plug-in from the six of the ten test runs. Because each test was the same as other runs with a different set of inputs, we presented the results of just six tests in Table 2.

Table 4: Input data and outcome values for six test runs

Test Run	Input Data Values		Core KPIs Values	
Test 1	CRV	\$ 10,000	CI	0.03
	DM(A)	\$ 300	MEI	100 %
	DM(T)	\$ 100	REI	100 %
	Cap. R.	\$ 50	FI	88 %
	Exp.	\$ 50		
	Req. A.	700 SF		
Test 2	CRV	\$ 20,000	CI	0.015
	DM(A)	\$ 300	MEI	200 %
	DM(T)	\$ 100	REI	100 %
	Cap. R.	\$ 50	FI	88 %
	Exp.	\$ 50		

	Req. A.	700 SF		
Test 3	CRV	\$ 10,000	CI	0.05
	DM(A)	\$ 500	MEI	50 %
	DM(T)	\$ 200	REI	100 %
	Cap. R.	\$ 50	FI	88 %
	Exp.	\$ 50		
	Req. A.	700 SF		
Test 4	CRV	\$ 10,000	CI	0.05
	DM(A)	\$ 500	MEI	20 %
	DM(T)	\$ 500	REI	100 %
	Cap. R.	\$ 50	FI	88 %
	Exp.	\$ 50		
	Req. A.	700 SF		
Test 5	CRV	\$ 20,000	CI	0.025
	DM(A)	\$ 500	MEI	40 %
	DM(T)	\$ 500	REI	100 %
	Cap. R.	\$ 50	FI	88 %
	Exp.	\$ 50		
	Req. A.	700 SF		
Test 6	CRV	\$ 20,000	CI	0.01
	DM(A)	\$ 200	MEI	40 %
	DM(T)	\$ 500	REI	100 %
	Cap. R.	\$ 50	FI	88 %
	Exp.	\$ 50		
	Req. A.	700 SF		

5.2. Analysis of the outcome (Core KPIs Values)

The outcome values indicate that the plug-in application is generating the right numbers and is responsive to the changes in the input data values. All numbers are matching to the manual calculations that were based on the mathematical expressions introduced in the literature.

As the mathematical expressions suggest and the plug-in outcome values show, REI and FI are not correlated to other core KPIs and this makes it easier to analyze their response to changes in the input data values. Overall, the outcome indicates that the plug-in and its algorithm work as expected.

6. CONCLUSION

This study was aimed to develop a tool for the purpose of measuring core KPIs based on the BIM model and other available data as well as utilizing the automation benefits that the BIM application offers. The application was developed through the Autodesk Revit Application Programming Interface (API) and was tested on a BIM model using several sets of input data. The algorithm was designed in such way that was able to retrieve geometric data from the BIM model as well as cost-related data from a corresponding Excel spreadsheet. Any changes done to the model can show their impact on the core KPIs. The primary benefit of this plug-in is that

it enables facility managers to connect a Revit model to a spreadsheet of their preference. That way, they have transparency and a complete control on KPI calculations in their spreadsheets.

The outcomes indicate that the developed plug-in application can be utilized to measure core KPIs in an efficient manner benefiting from automation and real time data access. Also, it can serve as a tool to study different input scenarios for different facilities in performance assessment.

This approach can be a foundation for development of other BIM-based automation tools for facility performance measurement and facility management in general. Considering the large number of maintenance and operation activities, facility managers can save resources by using similar automation tools that retrieve, consolidate and process data.

Future studies may focus on utilizing similar application for actual operation purposes feeding it with actual data. Also, such application can be used to simulate the performance of a facility over time or to track the performance of a certain facility.

7. REFERENCES

- Akcamete, A., Akinci B., and Garrett J. H. (2010). Potential utilization of building information models for planning maintenance activities. *Proceedings of the international conference on computing in civil and building engineering*, 151-158.
- Anoop, S., Salman, A., and Joseph, T. (2011). Preparing a building information model for Facility maintenance and management, *Proceeding of the 28th ISARC*, Seoul, Korea.
- Amaratunga, D., Baldry, D. and Sarshar, M. (2000a). Assessment of facilities management performance in higher education properties. *Facilities*, 18(7/8), 293-301.
- Amaratunga, D., Baldry, D. and Sarshar, M. (2000b). Assessment of facilities management performance – what next? *Facilities*, 18(1/2), 66-75.
- Building Owners and Managers Association. (2009). Gross Areas of a Building: Standard Methods of Measurement.
- Cable, J.H. and Davis, J.S. (2004). Key Performance Indicators for Federal Facilities Portfolios. *Federal Facilities Council Technical Report 147*. National Academies Press, Washington, DC.
- Golabchi, A., Akula, M., and Kamat, V. (2016). Automated building information modeling for fault detection and diagnostics in commercial HVAC systems. *Facilities*, 34(3/4).
- Jahangiri, B. (2016). Generating optimized cutting layouts of drywall panels using Building Information Modeling (Master's thesis). Texas A&M University, College Station, Texas.
- Lai, J.H.K., and Choi, E.C.k. (2015). Performance measurement for teaching hotels: a hierarchical system incorporating facilities management. *Journal of Hospitality, Leisure, Sport & Tourism Education*, 16, 48–58.
- Lavy, S., Garcia, J. A., and Dixit, M. (2010). Establishment of KPIs for facility performance measurement: review of literature. *Facilities*, 28(9/10), 440-464.
- Lavy, S., Garcia, J. A., and Dixit, M. (2014a). KPIs for facility's performance assessment, Part I: identification and categorization of core indicators. *Facilities*, 32(5/6), 256-274.
- Lavy, S., Garcia, J. A., and Dixit, M. (2014b). KPIs for facility's performance assessment, Part II: identification of variables and deriving expressions for core indicators. *Facilities*, 32(5/6), 275-294.
- Lavy, S., Garcia, J. A., Scinto, P., and Dixit, M. (2014c). KPIs for facility's performance assessment, simulation of core indicators. *Construction Management and Economics*, 32(12), 1183-1204.
- Sabahi, P. (2010). Speeding up the process of modeling temporary structures in a building information model using predefined families (Master's thesis). Texas A&M University, College Station, Texas.
- Yu, K., Thomas, F., and Francois, G. (2000). A development Framework for data models for computer-integrated facilities management. *Journal of Automation in construction*, 9(2), 145-167.
- Zhang, S., Teizer, J., Lee, J., Eastman, C., and Venugopal, M. (2012). Building Information Modeling (BIM) and safety: automatic safety checking of construction models and schedules. *Automation in Construction*, 29, 183-195.

DEFINING SPECIFIC PROBLEMS IN THE THAI GOVERNMENT HOSPITAL BUILDINGS. A STUDY OF ARCHITECTURAL PLANNING AND SPACE MANAGEMENT OF MAHARAJ HOSPITAL, CHIANG MAI THAILAND

S. Prugsiganont and P. A. Jensen

DTU Management Engineering, Technical University of Denmark

Email: prug@dtu.dk

Abstract: The purpose of this paper is to present and analyse the preliminary results of field work observation in one of the biggest government hospitals in Thailand – the Maharaj Hospital, Chiang Mai, Thailand. Hospitals in Thailand are the result of the imported concept from the European and American hospitals. The ideas of hospital architecture from Western countries have been adopted since nineteenth century until the contemporary period. Many of the Thai government hospitals constructed between 1960s and 1970s are still in use. The government hospitals are expanding (incremental development) without considering long term effects in the hospital planning. Therefore, this study investigated what are the factors that cause the incremental development of medical buildings in the Thai government hospitals. Moreover, this study investigated the current situations in a Thai government hospital (Maharaj hospital) where the hospital spatial arrangement is effected by the incremental development. The methodology of this study is done by reviewing literature of the Thai hospital landscape, building assessment tools such as Usability, Space management, and USEtool concepts. Later, an empirical survey (walk-through observations) is conducted to explore daily situations in the Maharaj Government hospital where the hospital is facing the incremental development. Data was collected by documentation such as architectural drawings and photographs and architectural plan analysis was implemented to analyse the spatial arrangement of the Maharaj Hospital planning and identify problems caused by the incremental development. This paper synthesize the findings from literature review of the Thai healthcare context and a walk-through observation in Maharaj hospital. According to the review of the Thai healthcare general context, there are three main factors that cause the incremental development of the hospital buildings (1) the lack of local general practitioners and poor services of primary care offered by community healthcare centers (2) limited number of government hospital (3) the implementation of Thailand’s universal coverage scheme. These three factors resulted in an easy access to government hospitals and dramatically increase of patient number. Therefore, hospitals need to expand to enabler sufficient services for the high number of patients. Walk-through observations identify and emphasis the effects caused by the incremental development of hospital buildings. The results from empirical survey show that confusion of way-findings and the overlapping between waiting areas and non-clinical areas are the problems caused by the incremental development. The problems caused by incremental development was created by two factors (1) the lack of planning in hospital architecture (2) the lack of integration of the Thai culture in hospital design.

Keywords: Government Hospital, Incremental Development, Plan Analysis, Thailand, Walk-Through Observation

1. INTRODUCTION

The development of hospital landscape, medical treatments, and hospital architecture in Thailand is influenced by the Western countries (Sarnpracharat, 1977; Seangwichean, 1988; Jungsteansup, 2016). This concept has begun since the beginning of nineteenth century and has never stopped. Nowadays Thailand provides public and private hospitals, both are under the authorization of the ministry of public health.

The healthcare industry is becoming more important around the world due to the raise of elderly population including Thailand. The Thai government plans to spend 2,865 billion Baht (7 billion Euros) on healthcare infrastructure (Thai Bureau of the Budget, 2015) between 2016 and 2018. Part of the budget will be spent on hospital construction (2.8 billion Euros). Thus, the government expects to constantly increase a long-term allocated budget (2016 to 2025) on healthcare and public health in order to improve the country's healthcare infrastructure.

The interests regarding hospital design including existing and new hospitals in Thailand has been raised due to the increase of allocated budget on healthcare construction. Moreover, modern trends of facilities planning has also become popular. The trends have been used as major strategies among healthcare facilities planners and professional practices in the past twenty years (Becker & Parsons, 2007). The focus of hospital design has shifted from building function to users, especially patients and staff. Moreover, Hamilton, (2003) stated that the design decisions based on information available from research is the best way to improve organization's clinical outcomes, economic performance, productivity, customer satisfaction, and cultural measure.

This paper focuses on related literature review of the Thai healthcare landscape and field work observations on Maharaj hospital Chiang Mai, Thailand. The review of literature and observations will present the current situation and also the problems in the Thai hospitals. The results from assessing the current physical settings of Maharaj hospital and the study of how the hospital has developed will illustrate a clearer view of the hospital architecture. Therefore, the suitable hospital design trends can be applied in order to improve the architectural problems in the Thai hospital.

1.1 Problem statement of this study

The purpose of this study is to have a better understanding regarding the general context of Thailand healthcare system and therefore the purpose of the study leads to problem statement of this study which are what is the general context of Thailand healthcare landscape and why the government hospitals are expanding rapidly what is the cause of the incremental development?

1.2 Research questions

- 1) What cause the incremental development in government hospitals?
- 2) What is the current situation in the hospitals that are encountering the rapid expansion?
- 3) What is the resulted caused by the incremental development of the hospital buildings?

1.3 Aims

This study aims to:

- 1) Identify factors that cause the rapid expansion of the government hospitals in Thailand
- 2) Collect preliminary data through a walk-through observation to experience the actual everyday situation in the Maharaj Government hospital
- 3) Identify problems that caused by the incremental development of the government hospitals

2. THEORY AND METHODOLOGY

This study is based on the literature review of the overall context of Thai healthcare system and an empirical survey with walk-through observations. Main purpose of the study is to identify factors which cause the incremental development of the hospital buildings and the way to improve the physical settings of the Thai government hospitals that comply with the context of the Thai local culture. Therefore, the Usability, Space Management, USEtool concepts have been employed for this study.

2.1 Usability

The usability concept stemmed from the evaluation strategies of consumer software products which involve user interfaces (Fronczek-Munter, 2016). The concept is a new paradigm that can be used to assess each individual satisfaction and their opinion toward the products.

Fronczek-Munter, 2016 stated that the concept of Usability in the field of architecture is known and often translated as functionality. However, some researchers claimed that there is a distinction between functionality and usability, the functionality in the building industry is objective measurable, whereas usability introduces the subjective view of users (Alexander ,2006, 2008, 2010; Jensen, 2010; Fronczek – Munter, 2011 stated in Fronczek- Munter, 2016). Therefore, the concept of usability can be used to evaluate the building differently depends on the groups of users. Nonetheless, the Usability depends on other major factors which includes context, culture, situation, and experience (Alexander 2008, 2010; Fronczek- Munter, 2016).

2.2 Space Management

Space Management (SM) is an essential aspect of Facility Management (FM) (Tinsfeldt & Jensen, 2014). The purpose of FM is to support and improve the effectiveness of the primary processes in an organization whereas SM is the concept of management space in facilities (CEN, 2006 stated in Tinsfeldt & Jensen, 2014). The main purpose of FM concept is to add value and optimize the use of space. Tinsfeldt & Jensen have defined the meaning of space optimization as there are two different approaches of the concept. A quantitative approach focuses on space utilization in terms of cost reduction and maximize the use of space whilst a qualitative approach aims to change the way that space is used to improve the effectiveness of the primary processes. Value Adding Space Management is the combination between the qualitative and qualitative approach of space utilization.

2.3 USEtool evaluation usability

USEtool is the evaluation method used to evaluate the usability of building the concept stemmed and developed from the research project of Norwegian University of Science and Technology (NTNU) (Hansen; Blakstad & Knudsen, 2011). The USEtool focuses on the performances and effectiveness of the usability of the building. The tool can be a useful methodology for the Facilities Management field in large organization or complex projects to evaluate their facilities together with the users (Tinsfeldt & Jensen, 2014). The essential part of USEtool is a facilitated walk-through in the buildings followed by a workshop together with users ((Hansen; Blakstad & Knudsen, 2011).

This study combines different methods which includes literature review regarding the generic context of Thai healthcare system the selected methodologies of usability, space management, and USEtool (a walk-through survey). Thus, a walk-through survey will give a clear view of the real situation in the government hospitals (Maharaj hospital) and a clear focus regarding the problem in the hospitals with the incremental development. However, the core of this study is to determine factors that cause incremental development and the effect of this development in the government hospitals (in this case Maharaj Hospital).

The research approach consisted of two parts; the first part is the review of general information of Thai healthcare system and its current situation. The second part is the empirical observation (a walk-through survey) of Maharaj Chiang Mai Hospital

The tool of the empirical research is the synthesis between three building evaluation concepts (Usability, Space management, and USEtool) and a walk-through survey. Thus, several walk-through routes were conducted regarding patient perspective. The walk-through routes include: out-patient department and in-patient department. Besides the walk-through survey hospital plans and blue prints were collected for architectural plan analysis; this methodology is well-known for the architectural research (Phaholtep, Sawadsri & Skates, 2016; Lantaron, 2016; and Verma, 2016). Architectural plan analysis is an efficient and a notable methodology used by many architects to present and understand the architectural design (Cabrero & Blas, 2012 stated in Vermo, 2016). Different type of drawings which include plan analysis have been used for a better analysis for selected cases and as a common code on results presentation (Vermo, 2016). An architectural plan analysis was used in this study to analyze spatial arrangement of existing buildings; it is important to understand the impact of physical environment between users and spatial arrangement of the building (van der Zwart and etc, 2016). Three out of five architectural plans (Boonsom Martin, Sujinno, and Tawan buildings) had to be digitally redrafted by the researcher from the original blue print, because the plans were originally drawn by hand in the 70s.

A walk-through survey took place in Maharaj Government hospital Chiang Mai Thailand. The hospital is one of the large scale teaching hospitals in Thailand where it provides 1,500 bed in the inpatient department (Ministry of Public Health Thailand, 2016). Thus,

Architectural plan analysis of the hospital observation in Maharaj hospital will define a future research focus and problems in the Thai government hospitals where the incremental development occurred. This paper briefly summarized the general context of Thai healthcare system and the empirical findings. The main focus of this study based on the results of the walk-through observations where the survey will present current situation in Maharaj hospital.

3. REVIEW OF GENERAL CONTEXT OF THAI HOSPITAL LANDSCAPE

According to literature review of the general context of Thai hospital landscape, there are three main factors of the Thai healthcare system that cause an incremental development of the hospital buildings.

1.) The lack of local general practitioners and poor services of primary care offered by community healthcare centers: Primary healthcare services in rural districts of the country provided by small local healthcare centers. However, the acceptability of local health centers as first line facilities is poor, when compared with the competing hospital-based services: all

hospitals (community until large) provide all services including primary care, which also available at local health centers (Srivanichakorn & Van Dormael, 1998; Pongpirul & Starfield, 2009; Prakongsai etc, 2009; Guinea & Sela, 2015; Satayavongtip, 2016). Moreover, the Ministry of Public Health Thailand has not launched strict regulations that every citizen is obliged to go to a local health center for primary care services (Ministry of Public Health, 2016). Therefore, people prefer to go to government hospitals, where the medical expenses is fully covered by government universal coverage welfare and social security service scheme (Srivanichakorn & Van Dormael, 1998; Satayavongtip, 2016). Furthermore, Thai people have strong believe that community hospitals are fully equipped with equipment and can, therefore, perform better treatment. According to the report of Ayutthaya Research Project (1990) doctors attending community hospitals at the out-patient department stated that 230 out of 442 cases (52%) could have been adequately treated at a local health center. Thus, government hospitals are overloaded with patients with simple problems. The daily routine in government hospitals is often chaotic. Hospitals are inefficient due to the overwhelm of number of patients with simple problems (Van Lerberghe & Lafort, 1990; Pongpirul & Starfield, 2009). Therefore, it is difficult to promote and improve health care service and hospital physical environment due to the lack of general practitioners and poor services of primary care of local healthcare centers.



Figure 1: Everyday situation at Siriraj Hospital (government hospital)

([http://www.bloggang.com/mainblog.php?id=tipsyg&month=26-07-15\)2009&group=14&gblog=1](http://www.bloggang.com/mainblog.php?id=tipsyg&month=26-07-15)2009&group=14&gblog=1))
retrieved on November 10, 2016



Figure 2: Everyday situation at Maharaj Hospital. Taken by: Supuck Prugsiganont (February 10, 2015)

2.) Limited number of government hospitals: Major hospitals are usually situated in the cities (mono centric location).

There are 202 government hospitals however, 78 hospitals are located in Central Thailand where 60 (77%) of these hospitals are based in Bangkok (Ministry of Public Health report, 2016). Nonetheless, there are only eight main hospitals in Chiang Mai the second largest city and less in small cities and suburb areas. Therefore, the ratio between number of hospital and its patients is 1: 320,000 from total Thai population 65.9 million (http://stat.bora.dopa.go.th/stat/y_stat58.htm retrieved: 15 January, 2106). People from rural districts commute into the cities in order to visit hospitals. As consequences hospitals are always overcrowded.

3.) The implementation of Thailand’s universal coverage scheme: The scheme has been introduced to the country in 2002. Thailand is universal coverage scheme (UCS) has direct impacted on healthcare access among the Thai citizens, the scheme has given Thai people an easy access to healthcare services and utilization since it first implemented in the last decade (WHO Report Back ground paper, 2010; Limwattananon, 2011; Pake & etc, 2016). Pake, Meemon, and Wan, (2016) stated that the implementation of universal coverage scheme (UCS) has impacted on health-seeking behavior. The number of patient has increased; especially number of low-income, vulnerable, and female patients. This resulted in two major aspects; accessibility (such as a long waiting queue or transportation; hospital wards that overloaded with patients) and acceptability issue (low services quality and dissatisfaction) (Limwattananon & etc, 2007; Damrongplisit & Melnick, 2009; Kirdrouang, 2011; Limwattananon & etc, 2011; Health Insurance System Research Office, 2012; Limwattananon, 2013; Pake, Meemon, Wan, 2016). Hospital wards are overloaded with patients.

These three factors are the general context of Thailand healthcare landscape which includes financing of the Thai government hospitals, structure of the governmental hospitals, and healthcare services provides by the Thai government which caused the imbalance between number of hospital and patients. Easy access to the government hospitals resulted in high number of patient and therefore, government hospitals are expanding rapidly causing incremental development of the hospital buildings.

4. RESULT FROM WALK-THROUGH OBSERVATIONS AT MAHARAJ HOSPITAL

4.1 General information of Maharaj Chiang Mai hospital

Maharaj Chiang Mai hospital was established in 1956 as an academic hospital of Chiang Mai University (Faculty of Medicine Chiang Mai University). Three years later, the Thai government with Chiang Mai municipality saw the significance of a regional hospital. Therefore, in 1959 Maharaj Chaing Mai Hospital was founded (Faculty of Medicine Chiang Mai University, 2009). According to the record of the hospital the first main building was constructed in 1972 and still in use as a main medical building for the whole hospital compound. The hospital expands throughout the years nowadays, there are five main medical buildings in the hospital compound (table 1).

*Table 1: List of medical buildings in Maharaj hospital and year the buildings constructed
Source: Faculty of Medicine Chiang Mai University, 2009*

Buildings	Built	Number of floors
Boonsom Martin	1972	8
Tawan	1975	6
Sujinno	1984	15
Sriphat	1994	15
Charempabaramee	2006	15

**remark: all the buildings named after important professors and people of Chiang*

Maharaj hospital, is the largest hospital in the Northern part of Thailand with 1,500 beds, and it is one of the most important government hospitals in the country. Moreover, the hospital is

the affiliation between the Ministry of Public health Thailand and Faculty of Medicine Chiang Mai University and as part of a teaching hospital. It provides primary, secondary, and referral treatments.

The hospital compound contains several medical buildings which include; educational buildings, medical service buildings, and a parking building. Each medical building offers different type of medical services.

4.2 Current state of Maharaj Hospital

As mentioned previously, there are five main medical buildings in Maharaj hospital. The buildings were added up randomly, where there was an empty space. Moreover, the incremental development of hospital buildings was done without long term planning. The functions in the hospital have been changed and remodeled several times in order to adjust to the present stage of the medical functions and services. The incremental development of hospital buildings stemmed from the dramatically increase of patient number in the pass twenty years. According to the statistic record of the Thai Public Health, the number of patients between 1992 and 2012 has increased from 3.7 to 12 million (Ministry of Public Health Thailand, 1992 - 2012), while the number of inhabitants has only increased from 58 to 67 million. In the year 2015, the outpatient department of Maharaj hospital served 1.2 million people (Maharaj Hospital, 2015). Therefore, the hospital is always chaotic and crowded.

Waroonkul and Jenjapoo (2016) did an evaluation study regarding healing environment medical wards in Maharaj hospital. The evaluation results, which examined the assessment from patients and the visitors of the medical ward, was rated as poor. Spatial layout criteria of the hospital received the lowest evaluation score (rated as poor) especially (1) unclear sign of telling paths and (2) distance between medical wards. Therefore, the investigation of Maharaj hospital by a walk-through observation will provide more precise information that can underpin the specific problems in the government hospitals. Moen, (2014) stated that a walk-through survey is of great methodology to evaluate the work environment. Moreover, important decisions can be made based upon the results from the walk-through inspection (Green & Thorogood, 2014).

Eight walk-through observation routes were conducted; three routes in outpatient department (OPD) and five routes in inpatient department (IPD). Nevertheless, in this paper only five different routes were analyzed (1) walk-in patient (2) patient with appointment (3) patient appointed to specialize clinic (4) walk –in patient (inpatient department) (5) specialize clinic (inpatient department); these routes are complex routes which happens as daily routes in the hospital.

4.3 Results from walk-through observations

A walk-through survey gives overview and in-depth information regarding the spatial arrangement (non-clinical spaces and medical wards) in Maharaj hospital. Moreover, this methodology provides users experience and usability related to selected topics (Hansen & etc, 2011 Fronzcek- Munter, 2013; Tinsfeldt & Jensen, 2014) where the effect caused by the incremental development of government hospital is the main focus of this study.

The results of walk through routes show that the routes are complex and confusing. There are several areas that overlapped; wayfinding and orientation are difficult to find, because all the buildings are connected. There are routes that the patients have to walk outside the buildings to enter another building without signage. The analysis is divided in two different parts; the OPD department (walk-in patient, patient with appointment, patient appointed to special clinic) and the IPD department (walk-in patient, specialize clinic); figure 5 illustrates architectural legends of each medical ward and area while figure 3 & 4 illustrate diagrams of the walk-through routes.

- **OPD walk-in and patient with appointment route:** there is no signs or clear information stating where is the main outpatient department/entrance or where is the registration area. Patients have to walk from the parking building to the hospital compound, which is approximately one kilometer. Because there is no clear sign most of the time, patients have to walk to the information center for the information regarding the route.

Way-finding is difficult due to the lack of the signage and the overlapping of the areas. Figure 6 explains the route of the walk-in/patient with appointment route; the red-line explains the route, where patients have to go since they are registered until discharged. It is clear that the overlapping areas (waiting areas with non-clinical areas) and disorganized or medical wards due to the incrimination of the buildings, create chaotic and inefficiency patient flow. For example: patients have to walk through restriction areas such as x-ray rooms and laboratories, before they could reach registration areas of outpatient department.

OPD Patient with the appointment route is also similar to the OPD walk-in route however, they do not have to go through the intake areas. Patients can directly go to the registration point. However, the route is still confusing with the lack of signage, too many overlapping areas, and unorganized medical functions.

- **OPD specialized clinic route:** the problems of the OPD specialized clinic route is very much alike the OPD walk-in route; no clear signage, several overlapping areas, unorganized medical wards due to the incrimination of the buildings. Nonetheless, the route is more complex due to the location of specialized clinics where the clinics located in four different buildings. This creates confusing way-finding to new patients regarding how to get from the registration point to the specific wards. Patients are obliged to walk from one to another building without any clear signs indicating where or which direction they have to go. Consequently, they often get lost. It is also difficult for vulnerable group of people, due to the distance that they have to walk to different buildings (figure 6 illustrated a walk-through route from a parking building until patients are discharged).

- **IPD walk-in patient route:** the IPD walk-in route is the most confusing route among the five walk-through survey routes. Before admitted, walk-in patients are required to register as a normal patient at the outpatient department. Thus, doctors will make the decision based on each individual case whether he/she is allowed admission. The process involves a lot of walking; begins with the registration point at the OPD department, if further examine is needed; patients have to walk to a laboratory or x-rays room. If a doctor requests a bed for the patient, then the patient needs to register as an IPD patient and later, they will be transferred to patient rooms which are located in four separate buildings. The location of the rooms depends on the treatments or patient deceases. Maharaj hospital offers both single bed and multi bed patient room. The most difficult route is the walking route from the registration areas to patient room which located in different buildings and different floors; without any clear sign. Moreover,

IPD patients share the route with OPD patients such as; elevators, corridors; waiting areas. The overlapped areas and routes create even more confusion in way-finding.

- **IPD specialized clinic route:** the route is similar to OPD specialized clinic route unless, the doctor made a decision that patients needed to be admitted to the hospital, then patient needs to go to the registration point again to register as inpatient department patient. The IPD specialized clinic route then share similar process as the IPD walk-in patient route.

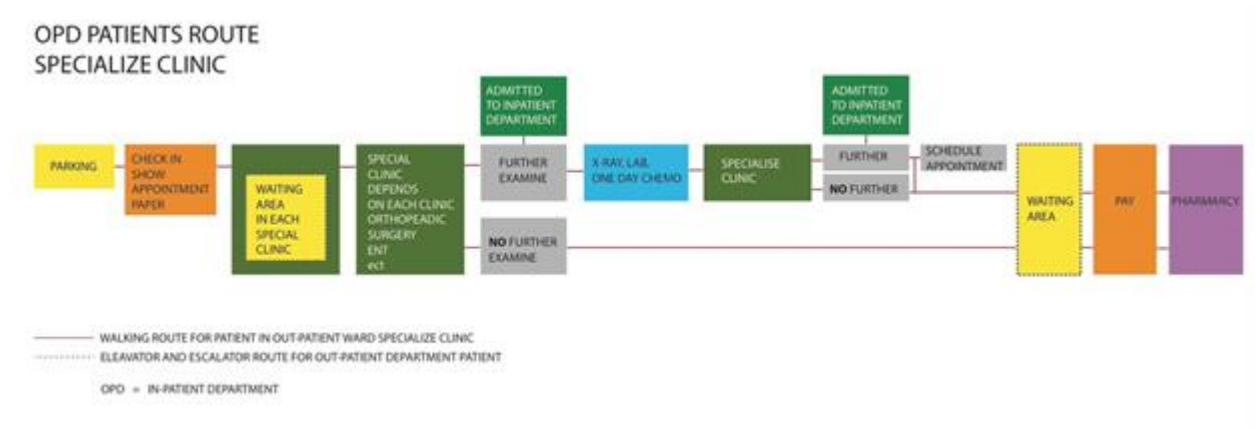

Figure 3: Illustrates diagram of inpatient specialized clinic route



Figure 4: Illustrates diagram of inpatient specialized clinic route

Legends	
1) Circulation	
1.1) Public corridor, hall, stairs, elevators, waiting area	
1.2) Internal	
1.2.1) treatment	
1.2.2) consulting	
1.2.3) non medical staff	
2) Support waste, laundry, kitchen storage, cleaning	
3) Zoning	
3.1) Intake	
3.1.1) Information	
3.1.2) Check in	
3.2) Outpatient department	
3.2.1) Internal medicine and overtime OPD clinic	
3.2.2) Specilized clinic	
- Surgical	
- Orthopedic	
- Pediatric	
- Other specialized clinic (include; psychiatry, oncology etc)	
- Dental clinia	
- Gyneacology	
3.3) Inpatient department	
- Internal medicine	
- Surgical	
- Orthopedic	
- Pediatric	
- Other specialized clinic (include; psychiatry, oncology etc)	
- Gyneacology (include delivery room)	
3.4) Emergency and Trauma	
3.5) Operating room (OR)	
3.5.1) Intensive care unit (ICU)	
3.5.2) Sub ICU	
3.5.3) Specialize ICU	
3.6) Medical services	
3.6.1) Pharmacy	
3.6.2) Laboratory	
3.6.3) X-RAY/Ultrasound	
3.6.4) EKG (electrocardiography)	
3.6.5) One day chemotherapy	
3.6.6) Dialysis	
3.6.7) Other medical services	
3.8) Morgue	
3.9) Office	
3.10) Service	
3.10.1) parking	
3.10.2) shop	
3.10.3) retstaurant	

Figure 5: Illustrates architectural legends of each areas of Maharaj Government hospital and each medical wards

PATIENT ROUTE AND PROCESS OF SEEING A DOCTOR AT MAHARAJ HOSPITAL

- In-patient department walk-in patient
- In patient department specialize clinic

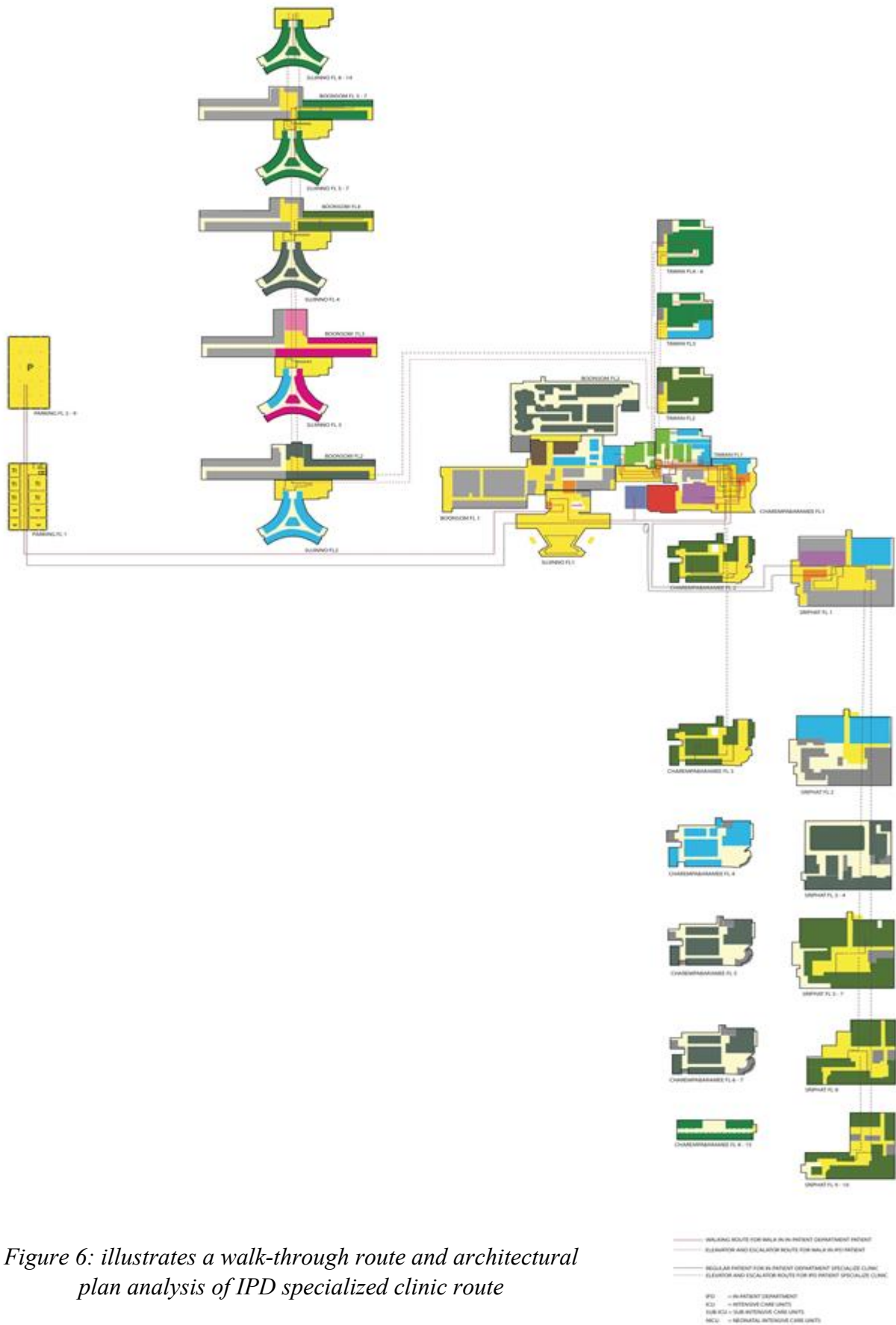

4.4 Analysis of the empirical survey

According to walk-through observations, the interior settings of Maharaj hospital were explored and problems caused by the incremental development were identified; which are (1) lack of clear signs and symbols which resulted in difficult way-finding and confusing orientation (2) the overlapping areas (waiting areas, hallways, medical ward, patient routes, visitor routes) (3) unorganized medical wards. These problems caused by the incremental development stemmed from two factors which root from the lack of long term planning and lack of research regarding the specific users (Thai people). Alexander (2008 & 2010) Fronczek- Munter (2011 & 2016) stated that the usability concept covers the subjective view of users. Moreover, usability buildings should be designed based on the context, culture, situation, and experience. Therefore, problems in government hospital, where the hospital is now facing the incremental development (Maharaj hospital) can be summarized into two aspects.

1.) The lack of integration of Thai culture in hospital design and architecture: There is no connection between physical setting of the hospitals and Thai culture due to the design, which is based mainly on Western design principles. Most of the government hospitals in Thailand were built during the 70s and most of the buildings are still in use. The lack of culture integration into the design is obvious for example: As a collective culture system (Hofstede, 2011; Riratanphong & van der Voordt, 2015). Thais usually visit hospital with the accompany of family and friends for social support. However, most of public spaces including waiting areas in government hospitals do not serve high number of visitors and long waiting times (figure 7 & 8).

As the new trends of hospital design have emerged in the past twenty years, hospitals are no longer responsible only for the medical treatment but also to serve people well-being (Phaholthep , Sawadsri , & Skates, 2016). Healthcare buildings and space usability should be designed based on users' activity and behavior (Fronczek- Munter, 2011; 2014 & 2016; Sahachaiseri, 2012; Phaholthep, Sawadsri, & Skates, 2016; Waroonkul & Jenjapoo, 2016). The built environment is an important factor to provide and support strong mental and physical of patients and staff.

2.) The lack of planning in hospital architecture: most of government hospitals are large scale hospitals. In the past twenty-years government hospitals have expanded rapidly due to the increase number of patients. Thus, Maharaj hospital was founded in the 1970s where at the contemporary period there are five main medical buildings in the hospital compound. These buildings are embedded into the existing ones without long term plan. The buildings are randomly added to the existing ones and placed on any available spaces creating the incremental development (figure 9 and 10). This development has resulted in a difficult way-finding which similar to a labyrinth. The catastrophe of architectural grown- mess in hospital architecture is happening in almost every complex and large scale hospital due to high number of patients.



Figures 7 & 8: anonymous waiting areas by the stairways and in front Supuck Prugsiganont (February, 2016)



Figures 9 &10: Development of Maharaj hospital in 1990s and 2015, Source: Facilities Management department Maharaj Hospital (February 10, 2016)

5. DISCUSSION AND CONCLUSION

This study is the investigation of the general context of the Thai healthcare landscape and current situation in the Maharaj government hospital Thailand. However, the core of this research is to identify the specific problems regarding planning and space management of government hospitals and the effect caused by incremental development of the hospital buildings. The study can be concluded as the way Thai healthcare system is implemented result in the incremental development. There are three factors that cause the development (1) the lack of general practitioners and poor services of primary care offered by community healthcare centers (2) limited number of government hospitals (3) the implementation of Thailand's universal coverage scheme. The results are the findings from the review of the Thai healthcare landscape. The walk-through survey gives the information regarding the current situation in the government hospital and the effect caused by the incremental development which can be summarized as (1) lack of clear signs and symbols which results in difficult way-finding and disorientation (2) the overlapping of areas (waiting areas, hallways, medical ward, patient routes, visitor routes) (3) unorganised medical wards. These problems are the results (1) the lack of long term plan and (2) the lack of integration in the Thai hospital design. Nevertheless, one of urgent problems that need attention is the overlapping areas between public areas and non-clinical spaces, especially the waiting areas that does not support long waiting queue and high number of patients. During the investigation it is clear that there are many information waiting areas created by patients and visitors and these areas are important among users. A study development and investigating on the use of informal waiting areas will be useful in order to develop further research.

6. FURTHER RESEARCH

After this study a continuation of an empirical case study will be conducted in St. Olavs Hospital Trondheim, Norway. The hospital is a precedent case study, where it had been through an incremental development in the 90s, remodelled, and finally rebuilt in 2000s. The core of this empirical observation is to conduct a comparative analysis between the Thai and Norwegian hospitals and to what extent that culture and context influence the design of the hospital and users? Thus, a more development study regarding the culture and behaviour of people will be considered during the observation and analysis. Further case study will be in Denmark. A cross case studies analysis between three cases studies (Thai, Norway, and Denmark) will be conducted focusing on the use of public areas concerning the cultural context. Final result will be generic recommendation on the improvement of the public areas in government hospitals and specific recommendation and design guideline for Maharaj hospital Chiang Mai University, Thailand.

7. REFERENCES

- Alexander, Keith. "Usability of Workplaces - Report on Case Studies." In *CIB International Council for Research and Innovation in Building and Construction*, 2006.
- Alexander, Keith. "Usability of Workplaces - Phrase 2." In *CIB- report 316*, edited by 2008 CIB and Euro FM Joint Project, 2008.
- Alexander, Keith. "Usability of Workplace - Phrase 3." In *CIB report 330*, edited by 2010 CIB and Euro FM Joint Project 2, 2010.
- Budget, Bureau of the. "Thai Bureau of the Budget 2015." 119, 2015.
- C. Phaholthep, A. Sawadsir, and H. Skates. "An Evaluation of Public Spcae Accessibility Using Universal Design Principles at Naresuan University Hospital." In *Designing Around People* edited by P. Langdon et. al: Springer International Publishing Switzerland 2016, 2016.
- Cabrero, Gabriel, Martin Blas, Sergio. *Casas En Suiza (Swiss Houses)*. NUTAC. Madrid: Mairea Libros, 2012.
- CEN/TC. "Facility Management - Part 1: Terms and Definitions." 2006.
- Charanya Phahothep, Antike Sawadsri, and Henry Skates. "An Evaluation of Public Space Accessibility Using Universal Design Principles at Naresuan University Hospital." Paper presented at the CWUAAT 2016 Designing Around People, 2016.
- Charanya Phahothep, Antike Sawadsri, and Henry Skates "A Comprehensive Poe Process for Investigating Service Efficiency Based on Universal Design Principles: A Case Study of Public Zones in Naresuan University Hospital." In *50th International Conference of the Architectural Science Association 2016*, edited by L. Daniel J. Zuo, V. Soebarto, 517-26. Adelaide, Australia: The Architectural Science Association and The University of Adelaide, 2016.
- Churngsathiansap, Koson. *Healthcare Architecture and Healing Environment*. Phim Khrang thi 1 ed. 2015.
- Division of Health Statistic Bereau of Health Policy and Plan office Ministry of Public Health, Thailand. "Public Health Statistic Thailand 1992." (1992).
- Dormael, Supattra Srivanichakorn and Monique van. "Conditions, Constrains, and Strategies for Increased Contribution of General Practitioners to the Health System in Thailand." *Human Resources for Health Development* 2 (1998): 15.
- etc, Johan van der Zwart and. "Building up/on Evidence, Healthcare Architecture Research in the Nordic Countries." Paper presented at the ARCH17 3rd International Confernece on Architecture, Research, Care and Health, Copenhagen Denmark, 2016.
- etc, Viroj Tangcharoensathien and. "Universal Coverage Scheme in Thailand: Equity Outcomes and Future Agendas to Meet Challenges." In *Background Paper, 43*, edited by World Health Report 2010: World Health Organization (Health System Financing), 2010.
- Fronczek-Munter, Aneta. "Usability and User Driven Innovation - Unity or Clash?" In *13th International FM & REM Congress January 19-21, 2011*. Kufstein, Austria, 2011.
- Fronczek-Munter, Aneta. "Usability Briefing for Hospital Architecture - Exploring User Needs and Experiences to Improve Complex Buildings." In *European healthcare design conference* 1-14. London 11-14 June 2017, 2016.
- Geir K. Hansen, Siri H. Blakstad, Wibeke Knudsen. *Usetool Eavuating Usability: Methods Handbook*. NTNU 2011, Norway, 2011.
- Hamilton, D. Kirk. "Four Levels of Evidence-Based Practice." 2004.
- Health, Ministry of Public. "Thailand Public Health Statistic between 1992 and 2012." <http://ghdx.healthdata.org/organizations/bureau-policy-and-strategy-ministry-public-health-thailand>.
- Hofstede, Geert. "Six Important Aspects of Cultural Dimension." <https://geert-hofstede.com/thailand.html>.
- J. Guinea, E.Sela and etc. "Impact Oriented Monitoring : A New Methodology for Monitoring and Evaluating of International Public Health Reserach Projects." *Reserach Evaluation Advance Access 2015* (2015): 1-15.
- Jenjapoo, Tanut Waroonkun and Teeradat. "Evaluation of Attributes for Healing Spaces of Medical Ward " Paper presented at the 20th World Buidling Congress (Intelligent Built Environment for Life) 30 May 2016 - 03 June 2016, Temepere, Finland, 2016.
- Jensen, Matte Tinsfeldt and Per Anker. "Value Adding Space Management in Higher Education." In *CIB Facilities Managment Conference 2014*, 369-80, 2014.
- Jensen, Per Anker. "Management for Usability of Learning Buildings " In *Usability of Workplace Phrase 3*, edited by In Alexander K (Ed.) (2010), 2010.
- Jungsteansup, K. (2016). *Healthcare Architecture and Healing Environment*. Nonthaburi, Thailand: Suksala and the Thai Health Promotion Foundation.
- K. Damrongplisit, GA Melnick. "Early Results from Thailand's 30 Baht Health Reform: Something to Smile About." *Health Aff (Millwood)* 28, no. 3 (2009): 457-66.
- Krit Pongpirul, Barbara Starfield, Supattra Srivanichakorn, and Supasit Pannarunothai. "Policy Characteristics Facilitating Primary Health Care in Thailand: A Pilot Study in Transition Country." *International Journal for*

- Equity in Health* 2009 8, no. 8 (2009).
- Lantarón, Heiter G. "Promoting Identity: Design Strategies for an Active Ageing." Paper presented at the ARCH17 3rd International Conference on Architecture, Research, Care and Health, Copenhagen Denmark, 2016.
- Moen, Bente E. "The Importance of Walk-through at Workplaces." *Occupational Medicine & Health Affairs* 2, no. 4 (2014).
- Parsons, Franklin Becker and Kelly S. "Hospital Facilities and the Role of Evidence-Based Design." *Journal of Facilities Management* 5, no. 4 (2007): 263-74.
- Phusit Prakongsai, Tassanee Yana, and Supattra Srivanichakorn. "Enhancing the Primary Care System in Thailand to Improve Equitable Access to Quality Health Care ". *SSRN Electronic Journal - December 2009* (2009). Publisher, Sarnpracharat. *The Father of Thai Modern Medicine*. Sarnpracharat Publisher Bangkok, Thailand, 1977.
- S. Limwattananon, V. Vongmongkol, P. Prakongsai, W. Patcharanarumol, K. Hanson and etc. "The Equity Impact of Universal Coverage: Health Care Finance, Catastrophic Health Expenditure, Utilization and Government Subsidies in Thailand " <http://r4d.dfid.gov.uk/Output/188980>.
- S. Limwattananon, S. Neelsen, V. Tancharoensathein and ect. "What Does Universal Coverage Do? The Impact of Health Care Utilization and Expenditure in Thailand " https://editorialexpress.com/cgi-bin/conference/download.cgi?db_name=CSAE2013&paper_id=674.
- Seangwichean, Sunchai. *100th Year Siriraj Hospital; History and Evolution*. Chulalongkorn Publication 1988.
- Seung Chung Paek, Natthani Meemon, and Thomas T. H. Wan. "Thailand's Universal Coverage Scheme and Its Impact on Health-Seeking Behavior." *Springer Open* Paek et al. SpringerPlus (2016), no. 5:1952 (2016).
- Team, Ayutthaya Research Project. "Twenty Months Experience from Ayutthaya Project." In *Presented at the International Seminar on Collaborative Health Systems Research, Ayutthaya, 1990*. Ayutthaya: Ayutthaya Project, 1991, 1991.
- Thailand, Maharaj Hospital Chiang Mai. "History of Suan Dok (Maharaj Government Hospital) Faculty of Medicine Chiang Mai University, Thailand." <http://web.med.cmu.ac.th/index.php/th/main-aboutus/med-cmu-history>.
- Thailand, Ministry of Public Health. "Thailand Public Health Statistic 2016." <http://ghdx.healthdata.org/organizations/bureau-policy-and-strategy-ministry-public-health-thailand>.
- Thorogood, Judith Green and Nicki. *Qualitative Methods for Health Research*. Los Angeles: SAGE, 2014, 2104.
- Verma, Ira. "Housing for Elderin in a Changing Social and Health Care Service Structure." Paper presented at the ARCH17 3rd International Conference on Architecture, Research, Care and Health, Copenhagen Denmark, 2016.
- Voordt, Chaiwat Riratanaphong and Theo van der. "Measuring the Added Value of Workplace Change: Performance Measurement in Theory and Practice." *Facilities* 33, no. 11/12 (2015): 773-92.
- Waranyou Satayavongtip, Aroonsri Mongkolchati, and Supattr Srivanichakorn. "The Percieved Transformation and Transactional Leadership Styles among Tambon Health Promting Hospitals Directors Related to Job Satisfaction in Nakhonratchasima Province, Thailand." *Journal of Public Health and Development* 14, no. 1 January- April 2016 (2016): 37-52.
- Wil van Jerberghe, Yelle Lafort. "The Role of the Hospital in the District: Delivering or Supporting Primary Health Care?" In *In current concerns, SHS Paper No. 2* Geneva: World Health Organization, 1990.

STATISTICAL OPTIMIZATION OF DEGRADATION CURVES: APPLICATION TO PAINTED RENDERED FAÇADES

V. Sousa¹, C. O. Cruz¹, I. Meireles², P. Moreira¹

¹ *Department of Civil Engineering, Architecture and Georesources, IST-University of Lisbon, Av. Rovisco Pais 1, 1049-001, Portugal*

² *Department of Civil Engineering, University of Aveiro, Campus de Santiago, Postcode, Portugal*

Email: viktor.sousa@tecnico.ulisboa.pt

Abstract: The research goal is to provide a tool for the asset managers plan their activities and evaluate the performance of their actions more accurately. With the increasing consolidation and aging of the built environment in the more developed countries, there was paradigm shift from new construction to rehabilitation of the existing ones. Additionally, the increasing sustainability awareness and resources limitation promoted the growing interest in asset management. Within this context, a key technical requirement for planning the asset management initiatives and evaluate the performance of alternative options is the forecast of the assets' components degradation. The present communication addresses the development of optimized statistical degradation models, illustrating its application painted rendered façades. The models developed are statistically sound, have high explanatory power and are simple to interpret and use, when compared with alternative approaches available in the literature.

Keywords: Asset Management, Degradation Curve, Painted Rendered Façades, Statistical Optimization

1. INTRODUCTION

In nowadays context, developed countries will face more the growing challenge of managing the existing built assets than the need for building new assets. The former requires making decisions regarding maintenance, renovation, refurbishment, rehabilitation, and replacement initiatives. Furthermore, the progressive inclusion of sustainability, for instance through the consideration of the life-cycle cost rather than the acquisition cost alone (e.g., recommendation of the Directive 2014/24/EU of 26 February 2014 on public procurement), contributes for bringing asset management into the discussion on the early stages of project development even in the construction of new assets. Also, organizations operating in a global and increasingly competitive context strive to improve effectiveness and overall operating performance, which requires an adequate management of their assets portfolio in order to optimize the strategies to comply with present and future needs.

A mark in the growth of awareness about the importance of asset management was the publication of the ISO 55000 family of standards in 2014. These standards provided a framework for implementing asset management focused on physical assets. Independently of the scale and the level in which asset management is being implemented, one of the requirements on the ISO 55001 is taking the asset life-cycle into consideration in the process.

For built assets, one key technical challenge for the implementation of asset management systems that needs to be addressed is the estimation of the components degradation. For the purpose of the present study degradation is assumed to be equivalent to different terminology found in the literature, namely: i) service life; ii) condition; iii) deterioration; iv) decay; and v) durability. The present communication aims to contribute for this topic by presenting an

approach for the statistical optimization of degradation curves and applying it to model the degradation of paint finishing over cement-based mortar rendered façades.

2. DEGRADATION MODELING

Forecasting built assets components degradation can be done with models providing a deterministic or a stochastic output (Sousa et al. 2014). The deterministic models' estimates are absolute and exact values while the stochastic models provide also some quantification of the uncertainty/variability of the degradation estimate. The majority of the models fall into the first category. Considering the complexity underlying the degradation of built assets components, stochastic models enable risk-informed approaches to complement the knowledge limitations regarding the degradation phenomena. In a risk-informed context it is important to evaluate the uncertainty of the degradation estimates in order to determine the best options and make the correct decisions regarding the assets' management.

The degradation models can be further classified into expert, empirical or mechanistic (Sousa et al. 2014). Expert models rely on the opinion of specialists to define the relation between the inputs and the outputs. These models require the existence of experts and assume that they have the capability to identify and evaluate the influence of the relevant characteristics determining the degradation of the built assets components. An example of such approach are some standards and regulations defining periodic interventions or service life of façade paintings. In Portugal the RJUE (2015) sets interval of 8 years between interventions. The empirical models are statistical-based, resorting to statistical methods and techniques to identify and express relations between known internal and external characteristics of the built assets components and their degradation from historical records. Implicitly, these models assume that the observed degradation pattern is representative of its evolution in the future. The mechanistic models seek to represent the physical, chemical and/or biological phenomena that govern the degradation of the built assets components. The work by Masters et al. (1987, 1989) set the general basis for most mechanistic models and Martin and Brandt (1996) present a review of the mechanisms and types of physical models for coatings. These models are potentially more accurate, but require a deep understanding of the degradation mechanisms and need information and data that, usually, is not available or cannot be easily obtained (Sousa et al. 2011).

The empirical models, also known as statistical models, are the most widely explored in academia and used by the industry (Lacasse and Sjoström, 2004). Data-mining is another frequently used terminology when resorting to the methods and techniques used to develop empirical models today. These models build on historical failure records or inspections and condition assessment reports. Considering the ever growing diversity of statistical methods and techniques, empirical models can be grouped into two main categories (Sousa et al. 2014): i) function-based models; and ii) data-based models. Both model categories resort to mathematical algorithms to determine functions relating known built asset components characteristics with observed condition or degradation through fitting to observed data. However, for function-based models the mathematical expressions relating the inputs with the outputs are pre-defined. In this case, the fitting operation seeks to determine the coefficients of the functions that minimize the error between the observed and the estimated outputs, assuming a fixed functional relationship between the explanatory variables. This category includes the traditional statistical methods and techniques, namely regression models (e.g., linear, non-linear, ordinal, nominal - Sousa et al. 2014, 2016), Markov chains (e.g., Paulo, 2009) or curve fitting (e.g., Gompertz, Weibull - Marteinsson, 2005), amongst many other. Data-based models

allow flexibility in the functional relationship between the explanatory variables and the fitting operation simultaneously adjusts the relation between the inputs and the outputs and the relative weight of each input. The methods and techniques in this category are frequently from the research on artificial intelligence/machine learning (e.g. artificial neural networks, support vector machines, fuzzy systems - Sousa et al. 2014) and it is not uncommon to classify them outside of the scope of the statistical models.

Table 1 resumes the main classes and types of function-based and data-based models that have been used for estimating painted rendered façades degradation. The range of possible approaches is larger, but haven't been applied to painted façades yet.

Table 1: Degradation models for painted rendered façades

CATEGORY	OUTPUT	TYPE	REFERENCES	COMPONENT
Function-based	Deterministic	Linear regression	Silva et al. (2013) Magos et al. (2016)	Rendered façades Painted façades
		Non-linear regression	Garrido et al. (2012)	Rendered façades
		Curve fitting (Gompertz, Potential, Weibull)	Costa et al. (2014)	Painted façades
	Stochastic	Logistic regression	Silva et al. (2016a)	Rendered façades
		Transition curves	Silva et al. (2014)	Rendered façades
		Markov chains	Silva et al. (2016b)	Rendered façades
Data-based	Artificial intelligence	Artificial Neural Networks	Silva et al. (2013) Dias et al. (2014)	Rendered façades Painted façades
		Fuzzy Systems	Vieira et al. (2015)	Rendered façades

3 STATISTICAL OPTIMIZATION OF DEGRADATION CURVES

3.1 Approach

A common method for developing degradation curves is to resort to the ordinary least squares regression. This method is easy implement and the resulting model interpretation straightforward. Therefore, in many cases, it tends to be the starting point when developing a degradation model and, when the results are good, the model actually used. However, there is a need to check if the assumptions underlying the method are not violated and to select the best set of explanatory variables. Also, when developing models with different number of explanatory variables an adequate metric needs to selected to compare the models performance.

The approach proposed comprises of the following steps: i) data preparation; ii) model development using different subsets of the explanatory variables based on their individual explanatory power (select first the variables with the highest explanatory power) and their multicollinearity (avoid using highly correlated variables); iii) model selection based on the Akaike Information Criterion (AIC); iv) outlier identification on the best model based on the Cook's distance (D) criterion ($D > 4/n$, with n the number of cases in the database); and v) tuning of the best model after removing the outliers from the dataset.

3.2 Implementation

Data preparation

For demonstrating the implementation of the methodology, the data collected by Magos (2015) was used. The data comprised of degradation data from inspection of 323 painted façades, including in the sample the façades inspected by Chai (2011). The data collection is outside of the scope of the present research, which was detailed in Chai (2011) and Magos (2015). However, the dataset has come some limitations that are important to report, namely: i) the parametrization of the building context (e.g., urbanization density, building geometry, humidity/pollution exposure, environmental exposure) was expert based and little detail is provided regarding the criteria used for its definition and classification; ii) the degradation of the paint was obtained by visual inspection from inexperienced master students; and iii) the dataset includes buildings with diverse ages and the material properties and construction technologies differences are not accounted for. Furthermore, the history of the buildings' façade maintenance is fairly unknown, except from the date of the last façade rehabilitation and the observed degradation.

Despite the limitations of the data, the dataset was used to develop a service life prediction model by Magos et al. (2016). In Chai et al. (2015), a portion of the dataset with 220 cases was used to develop a regression model for service life prediction using the 5 explanatory variables (exposure to humidity, distance from the sea, façade orientation, wind-rain action and paint finish), achieving an adjusted coefficient of determination (adjusted R^2) of 0,83. This dataset was also used by Dias et al. (2014) to model paint degradation using neural networks. A R^2 of 0.979 was obtained for a test sample of 35 cases using 3 explanatory variables (age, distance from the sea and façade orientation). However, the authors used only cross-validation and not k-fold or leave-one-out cross-validation, therefore the high R^2 may have been simply due to luck on the dataset split into training and testing samples and the resulting model is complex and hard to use and interpret comparing to a regression model.

Figure 1 replicates the regression model presented in Magos et al. (2016), but without excluding some cases that the authors did without providing a justification for it. The model is a simple 3rd order polynomial of the paint age.

Since the main goal of the research is to illustrate a methodology to build statistically optimized degradation models and the dataset was used for similar purposes in previous research efforts (Chai et al. 2015; Dias et al. 2014; Magos et al. 2016), it was considered valid despite the limitations discussed.

For numerical processing to be possible, the categorical non-numerical variables were converted into numerical classes according to the conversion matrix presented in Table 2. No special rules were used for the coding, only an attempt to code the variables with more than 2 categories using the implicit order of the classes (e.g., environmental exposure, finishing, distance to sea/river). The façade orientation coding used the observations of the degradation rate differences observed in the National Place of Sintra wood doors and windows (Sousa et al. 2016), where the West was found to be most aggressive orientation, followed by South, East and North coming in last. For the paint type and building use the coding was random. The variables with large number of classes (location and paint colour) were grouped. For the location the criteria for grouping was the relative location, with code 1 including Lisbon and limiting municipalities, code 2 including the municipalities along the coast line west of Lisbon and the code 3 including the municipalities in the south margin of the Tejo river. The paint

colours were grouped by light (1), medium (2) and dark colours (3) based on the photographs of the buildings available in Chai (2011) and Magos (2015), but some subjectivity exist in this classification.

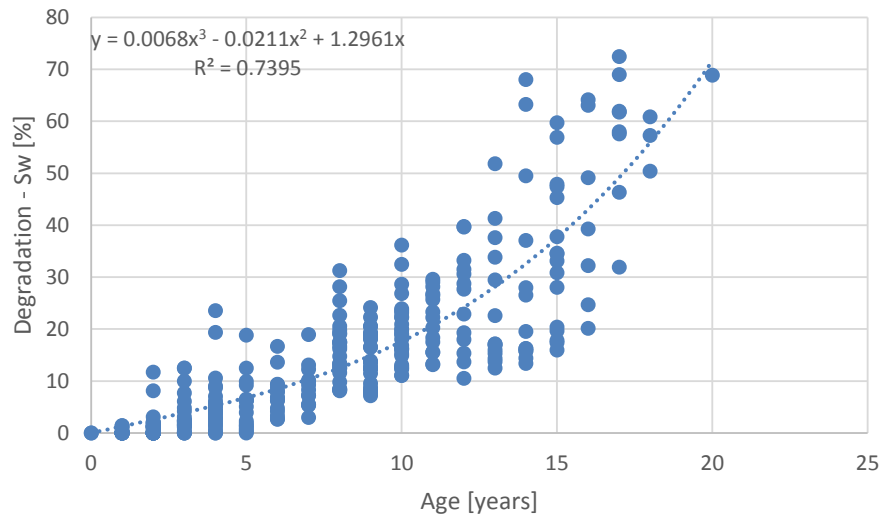

Figure 1: Original regression model presented by Magos et al. (2016)

Table 2: Categorical variables codification

Location	Code	Urbanization density	Code	Façade orientation	Code
Lisboa	1	High	1	North	1
Amadora	1	Normal	2	East	2
Loures e Odivelas	1	Building geometry	Code	South	3
Oeiras	2	Compact	1	West	4
Cascais	2	Irregular	2	Building use	Code
Sintra	2	Humidity/pollution exposure	Code	Residential/commercial	1
Almada	3	Normal	1	Residential	2
Seixal	3	Unfavorable	2	Services	3
Barreiro	3	Paint Colour	Code	Environmental exposure	Code
Moita	3	White	1	Light	1
Distance to sea/river	Code	Light pink	1	Moderate	2
< 1 km	1	Yellow	2	Severe	3
1 km - 5 km	2	Gray	2	Finishing	Code
> 5 km	3	Light green	2	Smoth	1
Paint type	Code	Light blue	2	Rough (fine)	2
Silicate	1	Orange	2	Rough	3
Smoth (Pliolite)	2	Dark pink	3	Gloss	Code
Smoth	3	Red	3	Matte	1
Textured	4	Dark green	3	Satin	2
Elastic membrane	5	Brown	3	Semi-matte	3

In addition to the variables listed and the paint age, the number of floors of the building was also an available variable.

Model development

During the model development, the gloss, building use, location and façade orientation were found to be either statistically non-significant or highly correlated with other variables with higher explanatory power. The resulting 10 best models are presented in Table 3, with the respective AIC criterion values.

Table 3: Best subset of models

Variables	Model									
	1	2	3	4	5	6	7	8	9	10
Urbanization density	X	X	X	X	X	X	X	X	X	X
Building geometry	X	X		X		X	X	X	X	
Distance to sea	X	X	X	X	X	X	X	X	X	X
Humidity exposure	X	X	X	X	X	X	X	X	X	X
Pollution exposure	X	X	X	X	X	X	X	X	X	X
Finishing	X	X	X	X	X	X	X	X	X	
Distance to river	X	X	X	X	X	X	X	X	X	X
Age	X			X	X	X	X		X	
Age ³	X				X	X	X		X	
Age ²		X	X	X				X	X	X
Paint type						X		X		X
Number of floors							X			
AIC	1299.7	1300.2	1300.8	1300.9	1301.1	1301.3	1301.5	1301.7	1301.8	1301.8

Model selection

The best performing model (model 1) was obtained using 9 independent variables with their relative importance presented in Figure 2. The relative importance was evaluated based on the normalized reduction in the sum of squares of the residuals due to the inclusion of each variable individually. This method is related to the usefulness index (Darlington 1968), but other approaches exist for evaluating the predictors' importance (e.g., dominance analysis – Budescu 1993; relative weight analysis – Johnson 2000, Tonidandel and LeBreton 2011).

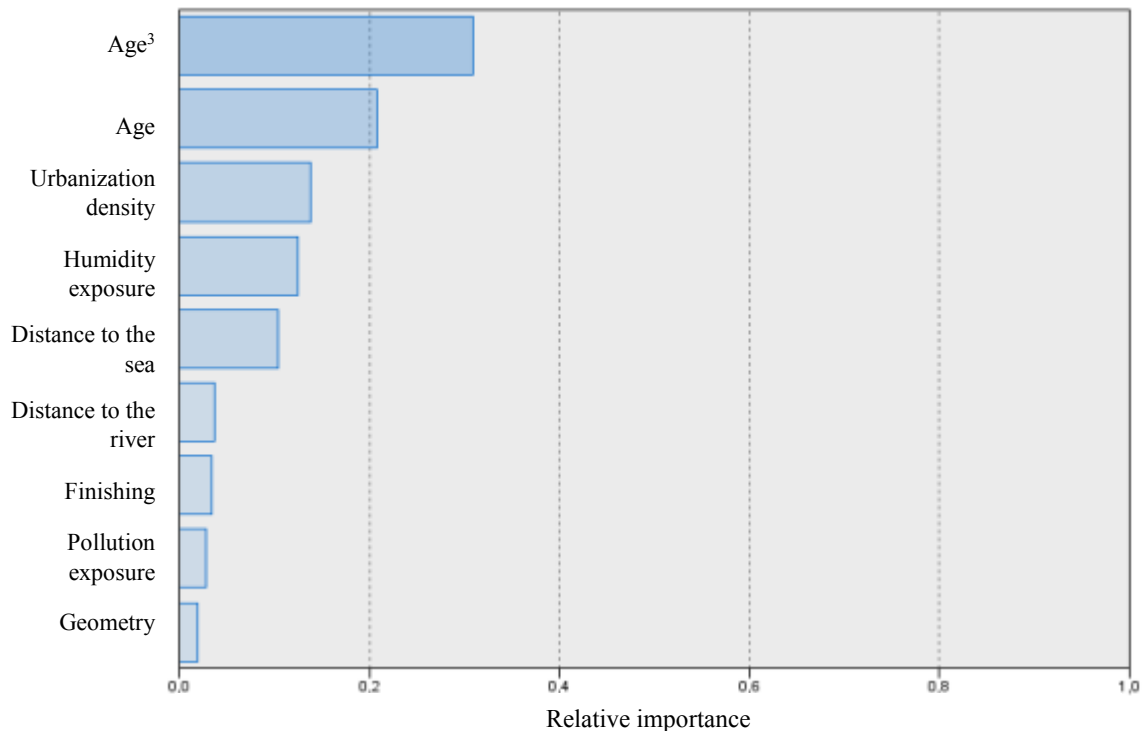

Figure 2: Relative importance of the variables in the best model

Outlier identification

Regarding the best model, 30 cases were found to exceed the Cook's distance threshold ($D > 0.012$), with values of D ranging from 0.013 up to 0.075. No pattern was found on the degradation of these cases that could help explaining their anomalous degradation, with the degradation indicator (S_w) ranging from 0.04 up to 72.45.

Model tuning

Removing the outliers, a new regression model was developed using the variables of model 1. The new model, designated as base model, was statistically significant with a R^2 of 0.916. Table 4 presents the ANOVA of the base model.

Table 4: ANOVA of the base model

Model		Sum of Squares	df	Mean Square	Z	Sig.
Base	Regression	85923,062	9	9547,007	343,798	0.000
	Residual	7886,473	284	27,769		
	Total	93809,535	293			

Analysing the regression coefficients of the base model, it is observed that the distance to river and building geometry are no longer statistically significant (p -value > 0.1) after removing the 30 outliers (Table 5). There was also a case with a standardized residual higher than 3, so regarded as an outlier.

Table 5: Regression coefficients of the base model

Model		Unstandardized Coefficients		Standardized Coefficients	t	Sig.
		B	Std. Error	Beta		
Base	Urbanization density	-4,439	,867	-,430	-5,122	,000
	Distance to sea	1,278	,463	,167	2,760	,006
	Humidity exposure	3,538	,921	,313	3,843	,000
	Finishing	-2,961	,659	-,268	-4,494	,000
	Pollution exposure	1,273	,754	,098	1,689	,092
	Distance to river	,304	,487	,039	,624	,533
	Age	1,169	,148	,551	7,913	,000
	Age ³	,006	,001	,447	9,840	,000
	Building geometry	1,101	1,050	,073	1,049	,295

An optimized model was developed removing the variables statistically non-significant and the outlier detected, resulting in an increase of the R^2 to 0.918. More importantly, since the models do not have the same number of variables, the adjusted R^2 increased from 0.913 to 0.916. The ANOVA of the optimized model is presented in Table 6 and the regression coefficients in Table 7.

Table 6: ANOVA of the optimized model

Model		Sum of Squares	df	Mean Square	Z	Sig.
Optimized	Regression	85232,457	7	12176,065	456,571	0.000
	Residual	7600,515	285	26,668		
	Total	92832,972	292			

In the optimized model, the pollution exposure was no longer statistically significant and since exclusion of the variable did not change the coefficient of determination, the final model does not include it and has the following expression (1):

$$Sw = -4.207 \times UD + 1.757 \times DS + 4.655 \times HE - 2.692 \times F + 1.136 \times A + 0.006 \times A^3 \quad (1)$$

where UD is the urbanization density; DS the distance to the sea; HE the humidity exposure; F the finishing; and A the age.

Table 7: Regression coefficients of the optimized model

Model		Unstandardized Coefficients		Standardized Coefficients	t	Sig.
		B	Std. Error	Beta		
Optimized	Urbanization density	-3,972	,724	-,387	-5,486	,000
	Distance to sea	1,518	,412	,198	3,683	,000
	Humidity exposure	4,296	,736	,382	5,835	,000
	Finishing	-2,910	,625	-,264	-4,659	,000
	Pollution exposure	,890	,711	,068	1,250	,212
	Age	1,117	,143	,528	7,832	,000
	Age ³	,006	,001	,466	10,457	,000

One of the limitations of the optimized model is the mathematical structure that does not warrants convergence to 0 when the age tends to 0, as it occurs in reality. To overcome this limitation, an alternative model was developed using a different mathematical formulation (2), resulting in a decrease of the R² to 0.858.

$$Sw = 0.756 \times A^{1.885} \times \left(-0.048 \times UD^{0.945} + 0.001 \times DS^{4.679} - 0.813 \times HE^{-0.281} + 1.099 \times F^{-0.072} \right) \quad (2)$$

Figure 3 compares the performance of the optimized and alternative models. It is possible to observe that the alternative model loose accuracy has the degradation increases, underestimating the observed values. This indicates that the interaction between age and the remaining variables is not correctly captured by the mathematical structure adopted for the alternative model.

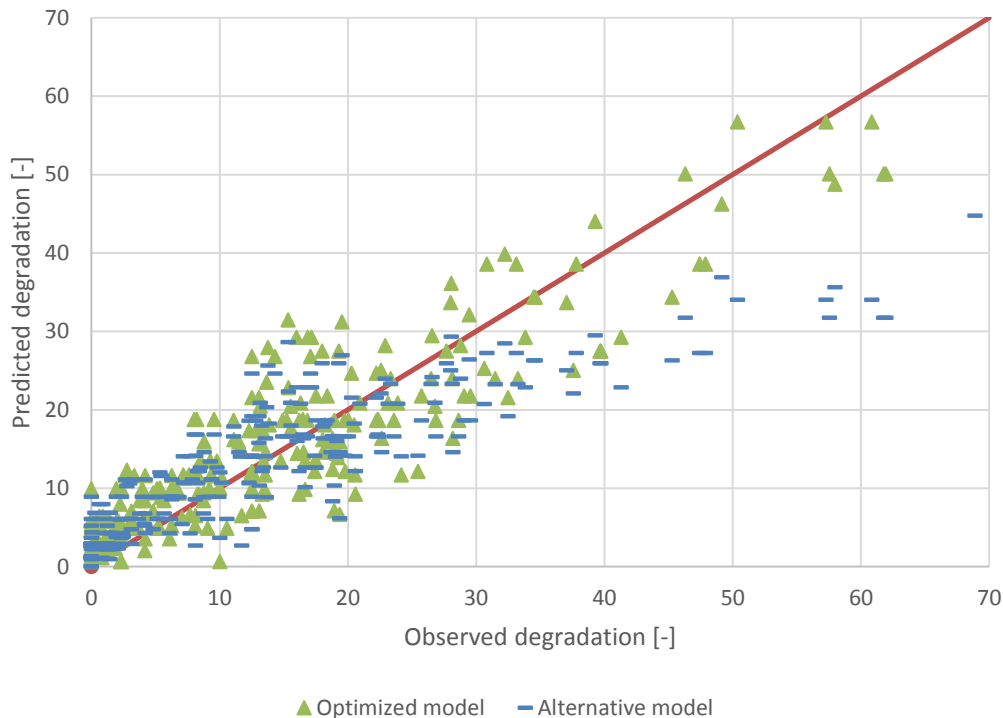

Figure 3: Comparison between the optimized and alternative models

4. CONCLUSIONS

The approach presented herein provides a framework for developing statistically robust degradation models when there is a multiple linear relation between the independent and

dependent variables. Its application to painted rendered surfaces proved to be successful, resulting in models with high explanatory power and easy to develop, use and interpret. Furthermore, the data screening method used is statistically based, therefore consistent with the nature of a statistical model such as these. This can be regarded a better option comparing with pseudo-expert based methods, such as the one used by Galbusera et al. (2014).

The approach is also valid for non-linear regressions, but it requires the variables to be transformed previously. Non-linearity and variables interaction can be modelled after transforming the variables into a linear model (e.g., power models can be determined using log functions), but the number of possible combinations makes it impractical. In these cases, the data-driven tools and techniques can be very useful. In this case, the multiple linear regression model already has a high explanatory power (R^2 of 0.918).

5. REFERENCES

- Budescu, D. V. (1993). Dominance analysis: A new approach to the problem of relative importance of predictors in multiple regression. *Psychological Bulletin*, 114:542–551.
- Chai, C.; de Brito, J.; Gaspar, P.L.; Silva, A. (2015). Statistical modelling of the service life prediction of painted surfaces. *International Journal of Strategic Property Management*, 19(2):173-185.
- Chai, C.V.V.C. (2011). Methodology for service life prediction of external paint finishes (on rendered façades) (in Portuguese). MSc. dissertation in Civil Engineering at Instituto Superior Técnico, Technical University of Lisbon, Portugal.
- Costa, J.; Paulo, P. V.; Branco, F. A.; de Brito, J. (2014). Modeling the evolution of stains in old building facades caused by collection of dirt. *Journal of Performance of Constructed Facilities*, 28(2): 264-271
- Dias, J.L.; Silva, A.; Chai, C.; Gaspar, P.L.; de Brito, J. (2014). Neural networks applied to service life prediction of exterior painted surfaces. *Building Research & Information*, 42(3):371-380.
- Galbusera, M.M.; de Brito, J.; Silva, A. (2014). The importance of the quality of sampling in service life prediction. *Construction and Building Materials*, 66:19–29.
- Johnson, J.W. (2000). A heuristic method for estimating the relative weight of predictor variables in multiple regression. *Multivariate Behavioral Research*, 35:1–19.
- Lacasse, M. A.; Sjöström C. (2004). Recent advances in methods for service life prediction of building materials and components – an overview. In: *Proceedings of the CIB world building congress*, Toronto, Ontario, Canada.
- Magos, M.; de Brito, J.; Gaspar, P.L.; Silva, S. (2016). Application of the factor method to the prediction of the service life of external paint finishes on façades. *Materials and Structures*, 49(12):5209-5225.
- Magos, M.M.T. (2015). Application of the factor method to the prediction of the service life of external paint finishes (on rendered façades) (in Portuguese). MSc. dissertation in Civil Engineering at Instituto Superior Técnico, Technical University of Lisbon, Portugal.
- Marteinsson, B. (2005). Service life estimation in the design of buildings a development of the factor method. PhD Thesis, KTH Research School, Centre for Built Environment, Department of Technology and Built Environment, University of Gävle, Gävle, Sweden.
- Martin, J. W.; Saunders, S. C.; Floyd, F. L.; Wineburg, J. P. (1996). Methodologies for predicting the service lives of coating systems. Federation of Societies for Coatings Technology, USA.
- Masters, L. W.; Brandt, E. (1987). Prediction of service life of building materials and components, RILEM Technical Committee, CIB W80/RILEM 71-PSL Final Report. *Material and Structures*, 20:55–77.
- Masters, L. W.; Brandt, E. (1989). Systematic methodology for service life prediction of building materials and components, RILEM recommendations, CIB W80/RILEM 71-PSL TC. *Material and Structures*, 22:385–92.
- Paulo, P. V. (2009). A Building Management System (BuildingsLife): Application of deterministic and stochastic models with genetic algorithms to building façades (in Portuguese). PhD Thesis in Civil Engineering at Instituto Superior Técnico, Technical University of Lisbon, Portugal.
- RJUE (2015). Regime Jurídico da Urbanização e Edificação - RJUE. Decreto-Lei n.º 555/99, de 16 de Dezembro, Portugal. (in Portuguese)
- Silva, A.; Dias, J. L.; Gaspar, P. L.; de Brito, J. (2013). Statistical models applied to service life prediction of rendered façades. *Automation in Construction*, 30:151-160.
- Silva, A.; Gaspar, P.L.; de Brito, J. (2016a). Comparative analysis of service life prediction methods applied to rendered façades. *Materials and Structures*, 49(11):4893–4910.

- Silva, A.; Gaspar, P. L.; de Brito, J. (2014). Durability of current renderings: A probabilistic analysis, *Automation in Construction*, 44:92-102.
- Silva, A.; Neves, L.C.; Gaspar, P.L.; de Brito, J. (2016b). Probabilistic transition of condition: render facades. *Building Research & Information*, 44(3):301-318.
- Sousa, V.; Almeida, N.; Meireles, I.; Brito, J. (2011). Anomalies in wall renders: Overview of the main causes of degradation. *International Journal of Architectural Heritage*, 5(2):198-218.
- Sousa, V.; Matos, J. P.; Matias, N. (2014). Evaluation of artificial intelligence tools performance and uncertainty for predicting sewer structural condition. *Automation in Construction*, 44:84-91.
- Sousa, V.; Pereira, T. D.; Meireles, I. (2016). Modelling the degradation rate of the wood frame doors and windows of the National Palace of Sintra. *Journal of Performance of Constructed Facilities*, 23:12-24.
- Tonidandel, S.; LeBreton, J.M. (2011). Relative importance analysis: A useful supplement to regression analysis. *Journal of Business and Psychology*, 26(1):1-9.
- Vieira, S.M.; Silva, A.; Sousa J.M.C.; de Brito, J.; Gaspar, P.L. (2015). Modelling the service life of rendered façades using fuzzy systems. *Automation in Construction*, 51:1-7.

BARRIERS TO AND CHALLENGES OF SUSTAINABLE FACILITIES MANAGEMENT PRACTICES – EXPERIENCES FROM THE NORDIC COUNTRIES

M. Støre-Valen¹ and M. Buser²

¹ Department of Civil and Environmental Engineering, Norwegian University of Science and Technology, Høgskoleringen 7A, N-7491 Trondheim, Norway

² Architecture and Civil Engineering, Construction Management, Chalmers University of Technology, SE-412 96 Gothenburg, Sweden

Email: marit.valen@ntnu.no

Abstract: The development of sustainable Facilities Management (FM) practices requires active and integrated engagement of the FM organisation and their users. The aim of this paper is to list the challenges that face FM practitioners when implementing sustainable FM within the Nordic countries. We start by looking at the barriers, which we identified within this field in the literature. The systematic literature review focuses on articles referring directly to FM, sustainability of FM and stakeholder involvement. The empirical material is based on input from a one-day workshop involving more than 40 practitioners and academics interested in sustainability and FM aspects as well as in-depth interviews with stakeholders in four ongoing refurbishment projects. We look into how FM suppliers and users benefit from a sustainable approach in refurbishment projects, and we highlight the current barriers and challenges in developing sustainable FM practice. We find that the involvement of FM, end users and other stakeholders is crucial for achieving a set of sustainable goals. Informal dialogue is useful for revealing barriers, and workshop arenas offer a stage for a participatory approach to developing sustainable FM practice. However, FM companies still seem to lack concrete tools to ensure users behave according to the new requirements of the facilities.

Keywords: Facilities Management, Stakeholders, Sustainability In Refurbishment Projects, User Involvement

1. INTRODUCTION

Sustainability concerns have created new demands regarding the collaboration between Facilities Management (FM) providers and their customers. The realisation of sustainable goals requires active participation from the users. FM managers in various sectors are striving to motivate their users to take part in implementing sustainability goals. Sustainability is widely accepted as “*improving the quality of human life while living within the carrying capacity of supporting ecosystems*” (IUCN/WWF, 1991).

When discussing sustainability aspects in the building sector, we talk about planning, designing, constructing and using a building in a way that serves the purpose of the users with optimal resources and a low carbon footprint over its life cycle. The building sector has mainly embraced its environmental responsibilities but not so much the social, cultural and economic responsibilities (Kaatz et al., 2005). In order to change that, Kaatz et al. (2005) argue that the sustainable development of a building “*is fundamentally about fostering participation through communication and dialogue, commitment and cooperation with stakeholders to exchange ideas, opinions and information grounded in mutual respect and shared responsibilities*”. The owners of real estate are slowly becoming aware of the need for partnership and collaboration with stakeholders as well as developing communication with the users in order to understand their needs and requirements. To date, a participatory approach has been adopted, using

different business models and planning systems (e.g. public–private partnership, partnering models, best value procurement, LEAN or other production planning models).

The sustainability of buildings has been explored broadly in the literature. However, few studies have looked into the interaction between the owners/investors and other stakeholders and their different requirements from the perspective of a sustainable retrofit of existing buildings (Storvang & Clarke, 2014). Such a collaborative and participatory approach would align the contrasting perspectives on how and why a building should have sustainable retrofits. The question then is two folds: first how to integrate the targeted users and their behaviours in this design process and then, how to ensure that once the improvements are realised, the users will align their behaviours with the components these new features require.

In order to discuss the development of sustainable FM and the integration of users we want to:

- (1) identify common barriers and challenges that hinder implementation of sustainable FM practices by integrating users,
- (2) discuss the user role and the need for information and tools that motivates change, and
- (3) discuss the FM role as a proactive player and motivator for reaching sustainable goals.

2. THEORETICAL FRAMEWORK

2.1 Sustainable refurbishment

ISO 15392:2008 defines sustainable development as “*a building that creates the required performance and functionality with minimum environmental impact and at the same time encouraging improvements in economic and social as well as cultural aspects at local, regional and global levels*”. In this paper, we use this definition when discussing the role of the FM organisation when developing a sustainable building in practice.

2.2. Barriers and challenges

Why do we study barriers and challenges when new technology and new knowledge should make it easy to reach sustainable goals? Obviously, there are still socio-technical barriers that hinder sustainability. We studied the barriers in achieving a sustainable approach when dealing with refurbishment projects and FM practice.

We looked at barriers and challenges reported in the literature reviewed by international researchers over the last twenty years. We, among others, consider these barriers to be general both for private housing and non-residential buildings (Sarpin et al., 2016; Jensen & Maslesa, 2015; Storvang & Clarke, 2014; Mensaasa & Bauer, 2014 Häkkinen & Belloni, 2011; Elmualim et al., 2009, 2010; Itard et al., 2008 and Kaatz et al., 2005). Kaatz et al. (2005) also considered the barriers to participation in the construction process as well as the need to develop innovative mechanisms to broaden membership of the construction project team.

The list of barriers and challenges are assessed by the authors of this paper as social (S), environmental (E) or financial (F) related to the business organization, users, competences, technology or policy instruments (see Table 1).

Table 1: Barriers and challenges that hinder the implementation of a sustainable FM practise found in the literature

Related to:	Barriers
Business organization	<ul style="list-style-type: none"> • Cost-effectiveness (F) • Lack of consensual understanding and focus on individual and organisational understanding of sustainability (S) • Concise decision-making framework due to complex processes (S,E and F) • Conflicting stakeholder requirements and agreement of sustainable goals for retrofit (S, E and F) • Lack of distribution of power, empowerment and capacity building (S, F) • Lack of information and knowledge about the building (S and F) • Lack of understanding of contextual issues (S) • Lack of integration of stakeholder knowledge (S) • Lack of strategic leadership and responsibility of driving essential change (S)
Users	<ul style="list-style-type: none"> • Awareness of the behaviour of the building's users (S, E and P) • Lack of understanding of contextual issues (S) • Lack of commitment to project goals, as well as enhanced process legitimacy through transparency and credibility of the decision-making process (S) • Lack of information and knowledge about the building (S and F)
Competences	<ul style="list-style-type: none"> • Awareness of the behaviour of different users of space (S, E and P) • Lack of professional competence and information (S and F) • Lack of strategic leadership and responsibility of driving essential change (S)
Technology	<ul style="list-style-type: none"> • Perception that sustainability-certified buildings do not guarantee energy savings (S)
Policy instruments	<ul style="list-style-type: none"> • Lack of incentives for private investors (also called the landlord/tenant dilemma by Jensen & Maslesa (2015)) (S, F) • Lack of funding for private owners (F) • Reluctant stakeholder commitment due to low energy prices (S and F)

The literature points towards two specific ways of overcoming these barriers: (1) the FM role can be a change agent, taking the strategic lead role to enhance the steps of development or implementing new practices (Nardelli & Scupola, 2014; Støre-Valen et al., 2014); (2) focus on stakeholder involvement and user integration (Buser et al., 2017; Menassa & Baer, 2014; Nardelli & Scupola, 2014).

2.3 FM Role

In Scandinavia, the FM role has developed from that of a property manager and janitor role as “hard FM” towards “soft FM”, focusing on the social and service needs of the organisation

(core business). This change has happened over the three last decades (Pemsel et al., 2010). Several researchers discussing the FM role state that the FM role needs to increase awareness of sustainability aspects. In best practice, the FM role can have a proactive role and take the lead in inviting and implementing change (Elmualim et al., 2010; Pemsel et al., 2010; Støre-Valen et al., 2014; Jensen & Maslesa, 2015). The FM role is important beyond the remit of a janitor, for example fixing problems and changing light bulbs; the best practice FM role also initiates and implements new sustainable processes. However, this requires the FM manager to take a strategic position to influence and direct change both in relation to the owner and the core business organisation. The researchers call this user-FM or client-FM related processes (Kaatz et al., 2005; Storvang & Clarke, 2014; Jensen & Maslesa, 2015).

2.4 Stakeholder involvement – the participatory approach

Another way to overcome barriers is by stakeholder involvement and user integration related to change management. Storvang & Clarke (2014) looked at how to set up a space for stakeholder involvement. They argued in favour of creating and facilitating a workshop as a socio-technical space across boundaries, to overcome barriers and improve stakeholders' involvement. In this way, the stakeholders would provide better insights about their values, needs, concerns and ideas. This process was important for creating trust and confidence; too many times the stakeholders have been involved in creative meetings to discuss needs and ideas but further along the road, either the architect or the engineer takes some decisions and forgets the sustainability goal that the stakeholder agreed upon earlier. The process of stakeholder involvement is crucial in order to increase knowledge and consensus about the sustainability goals and transparent decision-making.

We are not only talking about the end users, but also the engagement of all stakeholders that can influence the decisions in a sustainable way. Sezer (2012) studied environmental assessment tools for housing and office refurbishment and found that assessment tools in general focus on energy consumption and technical aspects like air quality, and light, noise, water and material consumption and rarely on the socio-technical side of sustainability. In this paper, we look at whether a social aspect can be a way to remove such barriers as found in the literature.

3. RESEARCH METHODOLOGY

This paper is based on the findings so far from the Nordic built project “Sustainable Operation of Buildings”. The project is a collaboration between four Nordic educational institutions: Norwegian University of Science and Technology (NTNU); Chalmers Technical University in Sweden; Copenhagen School of Design and Technology (KEA); VIA University College Horsens in Denmark and the Association of Building Professionals (Konstruktørforeningen). The goal is to strengthen and develop FM competence in the Nordic countries. The paper is based on complementary sources of information:

- A short literature review accomplished between December 2016 and June 2017.
- A one-day workshop and start-up conference: “*Nordic Sustainable Operations of Buildings*” held at KEA, 4 February 2016, Copenhagen.
- Interviews and workshops with selected stakeholders and project owners used as case studies at the Nordic Built Summer school: “*From Sustainable Refurbishment to*

Sustainable Facilities Management – A Summer School”, 13–17 March 2017, NTNU, Trondheim.

3.1 Short literature review

The literature review was used to inform the theoretical approach and aimed to answer the following questions: firstly, what hinders implementation of sustainable FM practice? Secondly, what is the user role and the user role’s need for information in relation to the building? And thirdly, how does the FM role help to achieve sustainable goals?

We looked at journals listed on the Web of Science, Scopus, Google Scholar and ARC using a combination of the following search keywords: *barriers and challenges, sustainable refurbishment or renovation, sustainable FM, user involvement/user behaviour, stakeholder involvement, energy performance, sustainability and innovation.*

3.2 “Nordic sustainable operation of buildings” (4 February 2016)

The conference gathered 48 people from practice and academia to share experience and their points of view of sustainable practice in a one-day workshop on 4 February 2016 in Copenhagen. The participants represented public and private owners, property managers, FM providers and suppliers, contractor companies, architects and consultants as well as researchers and academic staff with an interest in sustainability aspects of FM. The purpose of the conference was to share knowledge and experiences with sustainable operation and FM to identify barriers and challenges that hinder sustainable practice, and to discuss future needs of education and requirements.

The workshop divided the participants into small groups to discuss six different perspectives:

1. The design perspective
2. The FM supplier and provider as an interplayer
3. Certification as a method and incentive for sustainable operation
4. ICT as a tool for sustainability
5. Commissioning
6. The end user as change agent

Each group then had to reflect on the following questions:

- *What are their experiences with sustainable operation of buildings and what does a sustainable building mean from their perspective?*
- *What are the barriers to and challenges of a sustainable refurbishment project or what makes the operation more sustainable?*
- *What are the main drivers for change?*

The research team took notes and appointed referees in the group discussions. Each group summarised their findings on a poster that they shared in the plenum. The materials were analysed and discussed by the project team (notes, referees, presentations, posters and pictures).

3.3 Interviews and workshops with stakeholders (Jan-March 2017)

The project team arranged a “Sustainable Operation” summer school for 34 students from the four education institutions. The school was held at NTNU in Trondheim from 13 to 17 March 2017. The authors and the project team gathered information from the stakeholders and project owners using semi-structured interviews during January-February 2017. The workshops arranged for the project owners and the students, were executed during the Nordic Built Summer school, 13 to 17 March 2017. The choice of projects was made on the rationale of one project for each of the four educational institutions. Their choice of projects were naturally since the institutions were involved in these projects or had connections to the project owners. We also wanted to present a diversity of sustainable issues to the students. The projects varied, including social aspects of FM in social and private housing; issues of an FM supplier delivering technical installations; future sustainable FM solutions for a historical building for commercial purposes; and refurbishment of an education building for research and educational purposes.

4. RESULTS

We present our findings of barriers and challenges from the literature review and compare them with the barriers reported from practice. The barriers found from practice is based on the information shared from the practise on the Workshop on 4 February 2016 and the Nordic Built Summer School at NTNU (13 – 17 March 2017). We compare the barriers and sort them related to social (S), environmental (E), financial (F) or physical (P) aspects related to business organization, users, competences, technology and policies and instruments, see Table 2. We discuss the barriers and drivers briefly in the DISCUSSION chapter 5. The drivers we found from practice are listed in Table 3.

4.1 Barriers and challenges

Table 2: A summary of findings of barriers from the literature review and practice (Source: literature review; «Nordic Sustainable Operation of Buildings”, 4 February 2016; Nordic Built Summer School, NTNU, 2017)

Barriers		Theory	Practice
Business organization	• Cost-effectiveness (F)	yes	no
	• Lack of consensual understanding and focus on individual and organisational understanding of sustainability (S)	yes	yes
	• Concise decision-making framework due to complex processes (S,E and F)	yes	yes
	• Conflicting stakeholder requirements and agreement of sustainable goals for retrofit (S, E and F)	yes	no
	• Lack of distribution of power, empowerment and capacity building (S, F)	yes	yes
	• Lack of information and knowledge about the building – at a strategic level (S and F)	yes	yes
	• Lack of understanding of contextual issues (S)	yes	yes
		yes	no

	<ul style="list-style-type: none"> • Lack of integration of stakeholder knowledge (S) • Lack of strategic leadership and responsibility of driving essential change (S) • Lack of information and communication between the FM organization and client/user at tactical and operative level 	yes	yes
Users	<ul style="list-style-type: none"> • Awareness of the behaviour of different users of space (S, E and P) • Lack of understanding of contextual issues (S) • Lack of commitment to project goals, as well as enhanced process legitimacy through transparency and credibility of the decision-making process (S) • Lack of competence and knowledge about the building (S and F) • Perception that a certified building is the same as a sustainable building 	yes yes yes no	no no not explicit no yes yes
Competences	<ul style="list-style-type: none"> • Awareness of the behaviour of the building's users (S, E and P) • Lack of FM professional competence and information (S and F) • Lack of competence and information about the building • Lack of strategic leadership and responsibility of driving essential change (S) 	yes yes no yes	no yes yes yes
Technology	<ul style="list-style-type: none"> • Perception that sustainability-certified buildings do not guarantee energy savings (S) 	yes	no
Policies and instruments	<ul style="list-style-type: none"> • Lack of incentives for private investors (also called the landlord/tenant dilemma; Jensen and Maslesa (2015)) (S, F) • Lack of funding for private owners (F) • Reluctant stakeholder commitment due to low energy prices (S and F) 	yes yes yes	yes no yes

Table 3: Drivers for sustainable operations of buildings (Source: Nordic built Workshop and conference of sustainable operations, 4 February 2016)

<p>Drivers for sustainable operations from practice (FM suppliers, FM operators, FM managers, public and private owners, researchers, consultants)</p> <ul style="list-style-type: none"> • Digitisation and interoperability of ICT • Commissioning • A proactive FM provider in dialogue with the user • Policy and regulations • Social sustainability increases with user involvement • Industrialisation – reduced construction costs when the construction is based on standardised components • New competences and education
--

We address the need for new competences and education in another paper presented by Buser & Støre-Valen at the IRWAS2017 conference. This is a follow-up to a paper on learning using a problem-based approach (Buser et al. (2017).

4.2 Experiences from four Nordic refurbishment projects

The most common sustainable goals that project owners relate to are energy retrofits of buildings, including retrofitting insulation, changing windows to reduce drafts and heat loss, and improving the indoor environment by balancing heating, ventilation and air conditioning (HVAC), as well as considering the total energy balance of the building.

We found in the literature that the theoretical energy use per m² is not technically achievable on its own; rather, it is also affected by the involvement of users and this creates ownership and motivation for behavioural change (Itard et al., 2008; Meistad, 2015; Pedersen & Blomsterberg, 2016).

Table 4 provides an overview of the four refurbishment projects and their challenges and sustainability aspects used as cases at the Nordic Built Summer school (13 – 17 March 2017).

Table 4 Overview of the projects' challenges and sustainability issues as well as characteristics of the projects

Case projects	Ai-2, Åbyhøj	Grøndalsvenge	Britannia Hotel	University building
Building category	Residential housing/ cooperative apartments	Residential housing	Hotel	Education and office building
Owner	Ai-2 Bolig	KAB (residential company)	EC Dahls Eiendom	Chalmers University of Technology
Management, operation and maintenance	Ai-2 Bolig	Residents' responsibility	EC Dahls Eiendom	Chalmers Property Management AB
Goal of the project owner	Improvement of indoor environment and reduced heat loss by focusing on the residents' behaviour as a value-creating factor by 50% of the residents	Make affordable and sustainable housing for families living in the neighbourhood	To recreate the most magnificent and dignified hotel in Norway with focus on guests' perceived quality of the hotel. High ambitions of low energy use .	To create an attractive environment that inspires and supports the interaction between researchers, students and companies.
Sustainability concept	Environmental, economic and social aspects (energy use and indoor climate and user behaviour)	Low-energy housing for people, with low cost of construction and social sustainability based on active involvement of the residents through self-management of common areas	Environmental issues – low energy use challenged due to high guest demands, e.g. for comfort and temperature .	Upgrade to become environmentally certified at the silver level.
Challenges	How to involve the residents to reduce energy use and improve indoor climate	Maintain motivation of the residents to self-manage and operate housing and common areas. Ensure correct operation of technical installations. Information and communication platform.	The main building is protected, only the original façade remains. A lot of rot in the wooden beams and studs was detected.	Learning and workspace for students and academic staff. Physical meeting place for industry and research environment. Meeting place between both architecture and civil engineering education.
Innovation	A tool that can motivate the residents to actively participate in the operation and maintenance of the housing	Low cost due to industrial production. Idea of keeping the FM cost down by residents.	New ceiling material and design of indoor roof. Standard temperature setting and +2 °C temperature adjustments.	Modern facilities and work places, and more group rooms and lecture rooms.

5. DISCUSSION

In this paper, we aimed to: (1) identify common barriers and challenges that hinder implementation of sustainable FM practices by integrating users, (2) discuss the user role and the need for information that motivates change, and (3) discuss the FM role as a proactive player and motivator for reaching sustainable goals.

5.1 Common barriers and challenges for sustainable FM practices

Several barriers and challenges that hinders implementation of sustainable goals are identified in the literature. We found that the major barriers to sustainable refurbishment projects are: Lack of knowledge and information, paucity of cost-effective actions and low level of understanding of the FM and user role. Elmualim et al. (2009; 2010) and other researchers (Menassa & Bauer, 2013; Kaatz et al., 2005) confirm this.

The stakeholders from practise confirmed this. In the Britannia Hotel project, the project owner considered several technical installations to gain sustainability e.g. separation of grey water, thermal energy well, photovoltaic cells. This was not been implemented due to the cost issue. The hotel project mainly focused on technical installations that control the temperature in the rooms with an accuracy of ± 2 °C. For the Chalmers project, all actions suggested was feed-forward to the project owner, but the user role was not specifically involved in finding good solutions. In the two housing projects that struggled with finding ways to motivate the users to engage and take part in the operation, lack of information and incentives was found to be the stumbling blocks.

5.2 FM role as a proactive player

The literature points towards the proactive FM role of engaging users to reach sustainable goals by agreed measures (Elmualim et al., 2010; Pemsel et al., 2010; Støre-Valen et al., 2014; Jensen & Maslesa, 2015). Jensen & Maslesa (2015) and Støre-Valen et al. (2016) also highlight immaturity among FM practitioners in relation to value-based management regarding what gives value and addresses the service needs for the users. The stakeholders agree on this and say there is a lack of awareness about what it means to reach sustainable goals in practice.

The clients and users are driven by their individual and organisational values while the incentives for sustainable FM practice among FM organisations are driven by customers' needs and how well they are fulfilled. The digital revolution has already started and we will see more ICT tools and communication platforms in the future that we believe can become enablers for user integration and stakeholder involvement.

5.3 User role and information – the participatory approach

The literature points out ways for involving stakeholders and expertise in the concept phase planning in order to collaborate to find creative and innovative solutions that fit with future needs, known as co-creation or the participatory approach (Støre-Valen, et al., 2016; Meistad et al., 2013; Menassa & Baer, 2014; Kaatz et al., 2005). People from practice (both the suppliers and those from the owner side) confirm the need for such a framework, as they find it difficult

to handle user integration in a resource-optimal way, especially for private housing associations (Workshop, 4 February 2016). In addition, the FM providers confirmed the need for a user integration framework, as they expect clients and workplace tenants' awareness of the social aspects of sustainability to increase. This is also confirmed by Buser et al. (2017) and Nardelli & Scupola (2014). From the literature, we recommend Storvang & Clarke (2014) that designed a space for the involvement of stakeholders (framework) with the power to influence sustainable decision-making. This framework can be further developed and tested in practise.

5.4 Strengths and weaknesses

This research was based on a short literature review, workshops and interviews with stakeholders from the Nordic FM practice. The literature and the findings from practice give the same conclusions; however, there is a gap between the theory and practice when it comes to user integration. The workshop (4 February 2016) pointed towards a need for greater stakeholder and user integration in the future but the user role was not represented. Two of the projects from practice did not report on user or stakeholder involvement either. Therefore, we find it necessary that the FM role takes responsibility to develop the relationship with the users (client) to see how technical solutions of the FM practice can overcome barriers when implementing sustainable goals in the future. However, it is quite interesting to see that the practice confirms the findings from the literature and the need to drive towards a more participatory and collaborative approach between FM and customer- or user-oriented practice.

6. CONCLUSIONS

- lack of understanding of the values, needs, concerns and ideas of the user (the users are not listened to or taken seriously),
- space for stakeholder involvement needs to be well designed,
- insufficient input from the users: users are an important source of information and it is beneficial to integrate the user in the design process in a participatory way,
- lack of tools to communicate and engage the users in acting according to the sustainable goals, and
- the FM provider needs to be more proactive: it is important that a proactive FM provider is an active participant and translator of the user needs to reach sustainable goals.

Other barriers like cost-efficiency and consensual agreement have not been confirmed in practice. There seems to be a movement towards a more social approach, as the case studies have looked into socially sustainable practice with a high degree of user involvement; the case studies also highlight that the challenge then is to have the competence and space to deal with user needs as the FM role is handled by the users.

Lack of understanding of the values, needs, concerns and ideas of the user: the literature points out that the users are not listened to and their needs and values are not taken seriously in the early and pre-design phase (Jensen & Maslesa, 2015).

Stakeholder involvement: in order to succeed with stakeholder involvement, this needs to be facilitated in a way that ensures that user needs are implemented and not forgotten. The literature refers to several ways to do this and emphasises doing this in a participatory way

(Meistad, 2015; Pemsel et al., 2010; Menassa & Baer, 2014). The stakeholders interviewed in this research also confirm this.

View the user as an important source of information: the literature refers to the need to integrate the user in the design process in a way that influences the decision-making process. How such participatory approaches are practised are reported both from theory and practice perspectives (Meistad et al., 2013; Menassa & Baer, 2014; Pemsel et al., 2010; Workshop 4 February 2016; Nordic Built Summer School, 12–17 March, 2017). New technology and smart ICT platforms could contribute to bridging the gap in how to deal with this barrier in the future.

There is a *lack of tools to communicate and engage the users* to act according to the sustainable goals. The organisations we met are aware of the challenges that the users represent, and they have tried different methods such as participation, financial incentives, competition or nudging to engage the users to behave according to the new requirements of the facilities. However, they have not yet succeeded in securing the users' involvement and commitment on a long-term basis.

A proactive FM provider as an interplayer and translator of the user needs: the literature suggests that stakeholder involvement may contribute to possible FM service innovation as well as increased customer satisfaction and increased competitive advantage. This requires the FM provider to take the lead in collaborating with the customers or users to implement sustainable goals. The FM suppliers from practice confirm this.

7. REFERENCES

- Buser, M., Støre-Valen, M., Olsen, E. B. & Straub, M., 2017, *Developing interdisciplinary education to support sustainable operation of Buildings in the Nordic Countries*, Proceedings of the 9th Nordic Conference on Construction Economics and Organization, 13–14 June, Chalmers University of Technology, Gothenburg.
- Elmualim, A., Czwakiel, A., Valle, R., Ludlow, G. & Shah, S., 2009, The practice of sustainable facilities management: design sentiments and the knowledge chasm. *Architectural Engineering and Design Management*, 5 (1), pp. 91–102.
- Elmualim, A., Shockley, D., Valle, R., Ludlow, G. & Shah, S., 2010, Barriers and commitment of facilities management profession to the sustainability agenda, *Building and Environment*, 45(1), pp. 58–64.
- Häkkinen, T. & Belloni, K., 2011, Barriers and drivers for sustainable building, *Building Research & Information*, 39 (3), pp. 239–255.
- ISO 15392, 2008, *Sustainability in Building Construction – General Principles*, International Organization for Standardization (ISO), Geneva.
- Itard, L., Meijer, F., Vrans, E. & Hoiting, H., 2008, *Building renovation and modernization in Europe: State of the art review*, OTB Research Institute of Housing, Delft University of Technology, available at <http://iibw.at/documents/2008%20OTB%20TU%20Delft.%20Erabuild%20Building.%20Renovation%20Europe.pdf>, accessed 26/04/17.
- IUCN/WWF, 1991, *Caring for the Earth: a strategy for sustainable living*, IUCN, UNEP, WWF, Gland.
- Jensen, P. A. & Maslesa, E., 2015, Value based building renovation – A tool for decision-making and evaluation, *Building & Environment*, 92, pp. 1–9.
- Kaatz, E., Root, D. & Bowen, P., 2005, Broadening project participation through a modified building sustainability assessment, *Building Research & Information*, 33 (5), pp. 441–454.
- Meistad, T. R., 2015, *Sustainable building – From role model projects to industrial transformation*. Doctoral thesis, Norwegian University of Science and Technology, no: 270:2015, Tapir Press, Trondheim.
- Menassa, C. & Baer, B., 2014, A framework to assess the role of stakeholders in sustainable building retrofit decisions, *Sustainable Cities and Society*, 10, pp. 207–221.
- Nardelli, G., & Scupola, A. (2014). *Tools for Stakeholder Involvement in Facility Management Service Design*. Paper presented at CIB Facilities Management Conference 2014, Danish University of Technology, Copenhagen, Denmark, pp. 406–416.

- Nielsen, S. B., Sarasoja, A.-L. & Galamba, K. R., 2016, Sustainability in facilities management: an overview of current research, *Facilities*, 34 (9/10), pp. 535–563.
- Pedersen, E. & Blomsterberg, Å., 2016, Your House is My Home: Tenant Perceptions of Major Renovations including Energy-Efficiency Measures in Multifamily Housing in a Swedish Residential Area, in *Journals of Engineering and Architecture*, 4 (1), pp. 17–34.
- Pemsel, S., Windén, K. & Hansson, B., 2010, Managing the needs of end-users in the design and delivery of construction projects, *Facilities*, 28 (1/2), pp. 17–30.
- Sarpin, N., Yang, J. and Xia, B., 2016. Developing a people capability framework to promote sustainability in facility management practices, *Facilities*, 34 (7/8), pp. 450–467.
- Sezer, A., 2012, Environmental assessment tools and efficiency in housing and office refurbishment. In: Smith, S. D. (ed.), Proceedings of the 28th Annual ARCOM Conference, 3–5 September 2012, Edinburgh, UK, Association of Researchers in Construction Management, pp. 1331–1341.
- Støre-Valen, M., Boge, K. & Foss, M., 2016, Contradictions of Interests in Early Phase of Real Estate Projects – What Adds Value for Owners and Users?, In: K. Kähkönen and M. Keinänen (eds.) Volume I – Creating built environments of new opportunities, Proceedings of the *CIB World Building Congress 2016*, Tampere University of Technology, 1–3 June 2016, pp. 285–296.
- Støre-Valen, M., Larssen, A. K. & Bjørberg, S., 2014, Buildings’ impact on effective hospital services: The means of the property management role in Norwegian hospitals, *Journal of Health Organization and Management*, 28 (3), pp. 386–404.
- Storvang, P. & Clarke, A.H., 2014, How to create a space for stakeholders’ involvement in construction, *Construction Management and Economics*, 32 (12), pp. 1166–1182.

FACILITIES MANAGEMENT, OBSOLESCENCE AND DESIGN – THE TRIANGULAR RELATIONSHIP

R. Townsend¹, T. E. Butt^{*2}, T. J. Francis², J. Kwan³ and A. Peterson⁴

¹*Wernick Buildings, Unit 3a, Kenfig Industrial Estate, Margam, Port Talbot, SA13 2PE, UK.*

^{*2}*School of Architecture, Built & Natural Environments (SABNE), Faculty of Architecture, Computing & Engineering (FACE), University of Wales Trinity Saint David (UWTSD), Mount Pleasant Campus, Swansea, SA1 6ED, UK.*

³*CIRIA (Construction Industry Research and Information Association), Griffin Court, 15 Long Lane, London, EC1A 9PN, UK.*

⁴*Hochschule Mainz, University of Applied Sciences, Lucy-Hillebrand-Str. 2, 55128 Mainz, Germany.*

Email: t.e.butt@outlook.com

Abstract: Demands and requirements of the end-user of buildings are fluctuating faster, more frequently and probably at times more intensely. Whereas traditional, long-term buildings continue to be a more desired option as opposed to temporary, short-term buildings. This leads to accelerated obsolescence, correspondingly increasing maintenance cycles and costs for Facilities Management (FM). This paper presents an innovative conceptual model of optimization between long-term and short-term buildings, thereby minimizing unplanned obsolescence through planned obsolescence. The idea is that planned obsolescence can more appropriately mix short-term buildings with long-term buildings. Employing an analogy of a 'car-lease arrangement' the model is explained. A real-world case-study of an academic setting demonstrates a conceptual application of the model. The findings of this research reveal the concept can lead not only to relatively less maintenance costs and cycles, but also, correspondingly render it more possible to meet fluctuating demands of the modern-world end-user, whilst not unnecessarily compromising traditional, long-term buildings being replaced by short-term, modular buildings, probably best fabricated as off-site construction. This study can be of great interest to a diverse range of stakeholders belonging not only to the FM sector, but the whole construction industry including: building regulators and legislators, designers, developers, decision-makers, manufacturers, engineers, architects, and consultants.

Keywords: Built Environment, Facilities Management (FM), Obsolescence, Offsite Construction, Sustainability

1. INTRODUCTION

1.1 Background

Changes in the current modern-world are occurring at a pace faster than mankind has ever experienced for a whole host of factors ranging from technological advancements through environmental issues to economic pressures and globalization (Butt et al, 2015; Too et al, 2010). Consequently, demands and requirements of the end-user of buildings are fluctuating faster, more frequently and probably at times more intensely too. The implications of the aforesaid factors are necessitating the requirement for more strategic decision-making to enable built assets and/or buildings to continuously effectively perform functions in the ever changing and fast developing modern-world. This brings additional substantial onus on the department of facilities management (FM) and facility managers.

FM has grown to be a speciality and science in its own right, which is substantially multi- and inter-disciplinary. Irrespective of the fact that it is establishing as a rapidly developing field, still it is not sufficiently considered at the design stage in the construction industry, thereby leaving a legacy of challenges for FM to grapple with, once the building or structure has been

constructed and handed over for the occupational use, leading to many forms of obsolescence. Furthermore, the construction industry in general and the FM field in particular, do not appear to appreciate the potential of meeting fluctuating requirements of the client of the modern-world via short-term, temporary and flexible buildings/structures as opposed to long-term, permanent and fixed ones. Due to the exponential rate of change of the modern-world on the top of normal wear and tear increase over time, long-term buildings are FM intensive as they are subjected to a greater level of obsolescence than short-term buildings. Application of short-term buildings, mixed with long-term buildings to an optimal degree, can reduce the extent of obsolescence. Consequently, this can lower the burden on FM as short-term buildings, being more readily replaceable compared to long-term buildings, will continuously have the latest technologies keeping up with the escalating customer expectation and changing customer demands and needs.

On the other hand, obsolescence is still perceived as a relatively contemporary concept. In some industries obsolescence has been embraced and utilised strategically as a solution for its own existence. For example, mobile phones are intentionally planned to become obsolete in a certain period of time (Wieser, 2016). There has been little evidence of obsolescence being employed in a positive manner and yet in the construction industry. This research study explores the potential of inducing planned obsolescence in a positive manner while utilising the design element as a pivot to enable FM to control obsolescence via deploying short-term buildings in and along with long-term buildings. This is with the idea to reduce the full reliance on long-term buildings to help meet contemporary and fluctuating customer demands imposed on FM.

1.2 Aim and objectives

This study aims to establish implications of FM, obsolescence and design while assembling the three factors specifically in the context of combination of long- and short-term buildings. Thereby, conceptually outline an innovative approach/conceptual model to empower FM as a function to effectively control obsolescence with the engagement of design for a built environment setting. This aim is managed via the following key objectives:

1. Via literature review establish the state-of-the-art and knowledge gaps in terms of triangular relationship between FM, obsolescence and design;
2. Based on the identified knowledge gaps, develop a conceptual model interweaving the three individual factors;
3. Keeping in view the model in Objective 2 above, identify and map characteristics of long-term and short-term buildings in the context of advantages and disadvantages;
4. Identify a suitably representative case study to which the model is applied.

2. LITERATURE REVIEW

FM and Design by virtue of their nature are generally segregated at birth through the construction process (RIBA, 2013). Since, the process of design delivers a building and FM manages it thereafter, therefore, FM inherits obsolescence problems created and/or not addressed by the design process, though generally unknowingly due to lack of holistic consideration. Thus, FM is often left on its own devices to trouble shoot and find solutions to

manage resultant obsolescence related problems once the building becomes operational after completion.

The relationship between design and obsolescence has been the topic of much discussion and study for many years but more so in other industries than the construction industry. However, this relationship is becoming more apparent in recent times resulting from an enhanced and accelerated rate of change of the modern-world (Echegaray, 2016; Lobonțiu, 2013; Shen and Willems, 2014; Stacchetti and Stolyarov, 2015; Wieser, 2016) where the change ranges from technology through legislation, social values and climate change to standards of quality of life. This is presenting major challenges for the construction industry overall and FM in particular.

In industries, such as production, manufacturing, automobile, etc.; obsolescence in all its forms is controlled and managed via the same ‘original’ function – That is the designing. BMW, Mercedes, and Ford are a few examples of ‘non-construction industry’ in this regard. They design, manufacture and service/maintain their cars, allowing obsolescence problems to be identified beforehand, and therefore the process of designing is carried out (for the whole life span) accordingly. This way implications of obsolescence are strategically and successfully managed via the design function, and less problems are left for the repair or service (which is the counterpart of FM in the construction industry).

Another example is identified in mobile phones; where the obsolescence is harnessed and used to market and stimulate premature replacements (Wieser, 2016). However, the contrary argument can be *‘planned obsolescence is usually looked down upon as a business trick to get consumers to buy more products. But in a fast-changing world that obeys Moore's law, it might actually be a solution to better adaptation’* (de Oliveira, 2013). In the construction industry, however, inducing obsolescence (e.g. in the form of short-term buildings blended with long-term buildings) can rather be used as a strategy – thus, ‘positive’ planned obsolescence. This way, unplanned, unwanted, unforeseen obsolescence can be better reduced and controlled via the planned obsolescence. In this context, it may become even clearer that why modular construction, is regarded as a sustainable method of construction (Kamali and Hewage, 2017). This is because, before obsolescence becomes out of control; new, advanced and updated modular units – the short-term buildings – can be placed in a given built environment setting.

The construction industry in general and FM in particular have been recognising for decades, that designing has great potential to provide solutions to various ‘later on’ problems including that of obsolescence (Lee, 1987, p.338; Seeley, 1987, p.1; Spedding, 1995, p.74). But the distant relationship that exists between FM and designing results in insufficient and inefficient information at the design stage, thus, this gap between the two departments eventually leads to increased, unforeseen problems of obsolescence for FM to grapple with later on (Alexander, 1996, p.5).

This is also evidenced by Abramson (2016) in his publication entitled *‘Obsolescence: An Architectural History’*. This publication mentions obsolescence being controlled by design. However, despite being one of the most recent publications and despite covering the topic of obsolescence in much detail, it still does not recognise or consider obsolescence in connection to FM – nor do the architects case studies that this book presents. To fully harness the potential of design the construction industry must recognise the link between design and FM, so that problems regarding buildings that are currently left for FM to inherit, can be strategically designed out or catered for in anticipation.

The review of the literature by the principal authors establishes that there is not a great amount of literature available which clearly, exhaustively and categorically recognises the inter-relationship of FM, obsolescence and design. Furthermore, there seems to be no literature which takes into account all the three factors together specifically in relation to long- and short-term buildings and other associated implications such as: maintenance and refurbishment and their cycles; cost-benefit analysis; obsolescence types; building regulations and legislation; technological advancements; and assessment of change in user demands, expectations and needs, and corresponding flexibility to cater for these.

In the literature to date, where relationships of the three facets have been identified (Allehaux and Tessier, 2002; Conejos et al, 2015), the strategies still pertain to resolve problems within long-term buildings by attempting to plan and measure future requirements. Thus, the approach of blending short-term buildings with those of long-term is not appreciated as a possible means of controlling obsolescence. If, as Wood (2003) suggested, it is not worthwhile planning for the future, specially quite accurately and given the fast change that has been occurring in the last few decades, then the question arises that why to still bother? Probably, one answer can be as follows: If the construction industry could learn from its recent past and also other industries (examples given above) that are successfully managing obsolescence in the modern, fast changing world. Then strategic alignment of the three facets – FM, obsolescence and design – can be recognised as a potential solution to alleviate current, diverse obsolescence problems in the form of optimal blending of long- and short-term buildings.

3. INNOVATIVE MODEL DEVELOPMENT

3.1 Triangular concept

FM, Obsolescence, and Design are the three main factors or dimensions that this study is basing the innovative idea of optimal combination of long- and short-term buildings on. Although these three main factors or facets exist in their own individual right, but by combining the three together, obsolescence implications and drivers can be better managed to render job of a facility manager relatively easier and the building(s) less FM intensive. There have been found no studies which combine the foresaid three factors into one single entity as a trinity concept, thereby clearly establishing how the three can be appreciated at the design stage of a building such that unplanned obsolescence is replaced by planned obsolescence. The proposed innovative conceptual model is presented in Figure 1 with the three vertices of the triangle corresponding to the three main factors or facets, one each. The question mark in the middle of the triangle is to reflect on various implications that arise between the three main factors when placed together. Some examples of these implications are contained in Figure 9 in the form of advantages and disadvantages while seeking a combination of long- and short-term buildings.

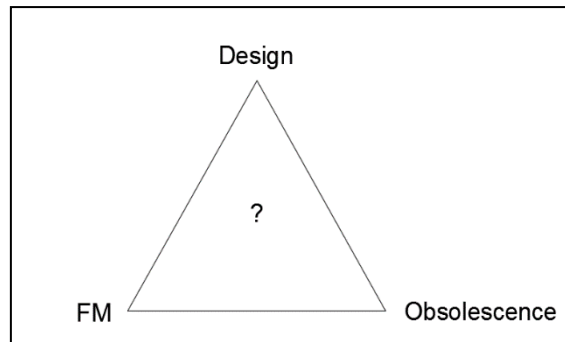

Figure 1: Innovative Triangular Concept – The Trinity

The idea is that when a long-term building is no longer meeting demands of the user/owner, instead of constructing yet another long-term building to cater for the grown demands of the user, why not design and develop a short-term building. The former (i.e. the long-term building) though will have unplanned obsolescence whereas in the latter (i.e. the short-term building) a planned obsolescence approach can be applied so that when the demands change yet again the FM is not left with a relatively inflexible long-term built asset but a short-term flexible built asset. The planned obsolescence is being applied in a positive manner and can be referred to as Positive Planned Obsolescence (PPO) – this itself is a new conceptual term for the construction industry that this study introduces.

An analogy can be drawn in the form a lease-car-arrangement to describe the concept as follows: The automotive industry continuously updates and improves vehicles (cars in particular) so that they have the latest technologies to remain competitive and relevant in a market driven by consumerism – the protection and/or promotion of the interests of customers. Vehicles are thus hired on a lease purchase arrangement and traded in come the end of the lease term for a newer car-model which will have the latest technologies and fashions. For example, the new SEAT Ibiza is currently being advertised with the new technology of wireless phone dock chargers that have recently hit the consumer market (SEAT, 2017). Such car leases are generally occurring on three- to five-year arrangements indicating the rate at which technology and ideals/standards of consumerism are changing.

Similarly, consumerism standards/ideals are now being applied to buildings. This is because like cars (automobile industry), buildings are increasingly and continuously requiring updating to meet consumerism ideals of the modern-world. Thus, short-term buildings approach has a substantial potential to be unlocked in order to effectively meet desires and maintain functions at all times, thereby, keeping up with the fastest change rate of customer demands and requirements to which the built environment has ever been subjected.

A modular building in its simplest form is fundamentally a product (like a car) which can be continuously developed and mass produced to replace existing, old, outdated ones or part thereof. Thus, there is a considerable potential of meeting traditional building standards and preferences, through a modular building type product which previously was not as readily achievable with old construction methods but now can be in the current high-tech world. Currently, it seems that existing modular building products are only those that either embrace the temporary properties for a cost effective solution but not aesthetically-pleasing, or those which embrace the permanent properties of long-term buildings thus providing a more aesthetically pleasing look but without as much flexibility and upgradability. See Figures 2, 3, 4 and 5. However, the proposed solution is believed to be achievable whereby the temporary

properties are embraced whilst providing an aesthetically pleasing solution, similar to that of a long-term building.



Figure 2: Temporary Modular Building – aesthetically non-pleasant (Wernick, 2017a)



Figure 3: Temporary Modular Building – aesthetically pleasant (Wernick, 2017b)



Figure 4: Permanent Modular Building – aesthetically less pleasant (Wernick, 2017d)



Figure 5: Permanent Modular Building – aesthetically more pleasant (Wernick, 2017c)

Some attempts have been made along the aforesaid lines such as the Nakagin Capsule Tower in Tokyo (Abramson, 2016, p.96). However, while seeking a blend or mix of long- and short-term buildings' properties, FM considerations have been seriously lacking. Therefore, this leads to buildings which could not be used for as long as originally intended. The reason being that the appropriate blend of long- and short-term buildings' properties is not achieved specifically keeping in view FM implications. This study investigates this matter to develop a holistic conceptual model that may capture and accommodate a diverse and wide range of variables such as rapid technological advancement, knowledge enrichment, economic growth, aesthetical desires, and the list never ends. However, given the brevity of the paper and scope of the study, each and every variable is not considered, but only a few as examples are catered for in the conceptual model development in the form of advantages and disadvantages. See Section 3.2 for more details.

3.2 Trinity conceptual model

The conceptual diagram in Figure 6 depicts the rate at which obsolescence is perceived to occur over time. The exponential rate of change means that it is accelerating towards the unacceptable performance level requiring some form of FM action to remediate or rectify the growing obsolescence. The FM function is thus correspondingly increasing with obsolescence as conceptually depicted in Figure 7. FM requirement can therefore be considered as directly proportional to obsolescence. By introducing solution through design, it is possible to remedy obsolescence. This can be depicted by adaption of Douglas's Life-Cycle Model of a building, as shown in Figure 8.

This life cycle model demonstrates that as demands grow, decisions can be made that reduce the gap of obsolescence to acceptable levels be it through maintenance, refurbishment or redevelopment. However, it can be seen that the long-term building (for which the Douglas model is developed) is continuously struggling to manage the rate at which obsolescence is occurring and the applied solutions currently in existence only limit the problem – they never completely solve the problem. The proposed 'Trinity Conceptual Model' in Figure 9 presents a solution that can reduce the burden on FM via design.

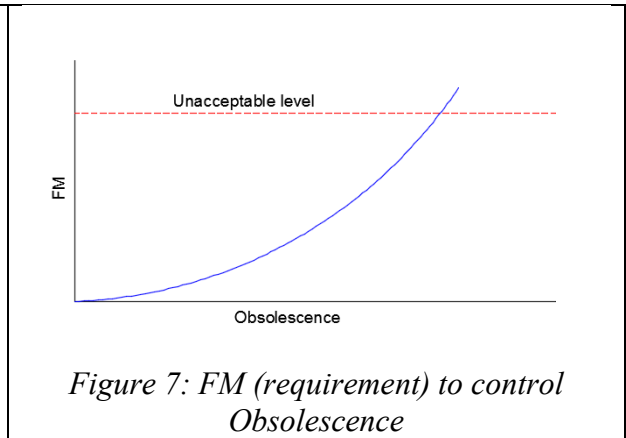
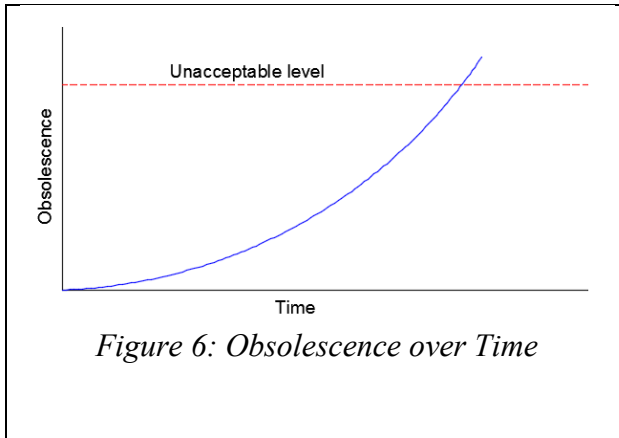

Design can enhance ability of FM to control obsolescence in a cost effective manner, be it planned obsolescence or un-planned. However, the planned obsolescence in this innovative conceptual model is employed in a positive context as opposed to in some industries being used in negative context to compel consumers to buy their products more often, such as mobile phones, mobile phone batteries, laptops, etc. (Wieser, 2016). But in the trinity conceptual model, this negative obsolescence is being accommodated as a positive obsolescence with absolute transparency. That is, short-term buildings blending with the long-term buildings in such a way that technological, financial and other types of obsolescence can be effectively managed by FM.

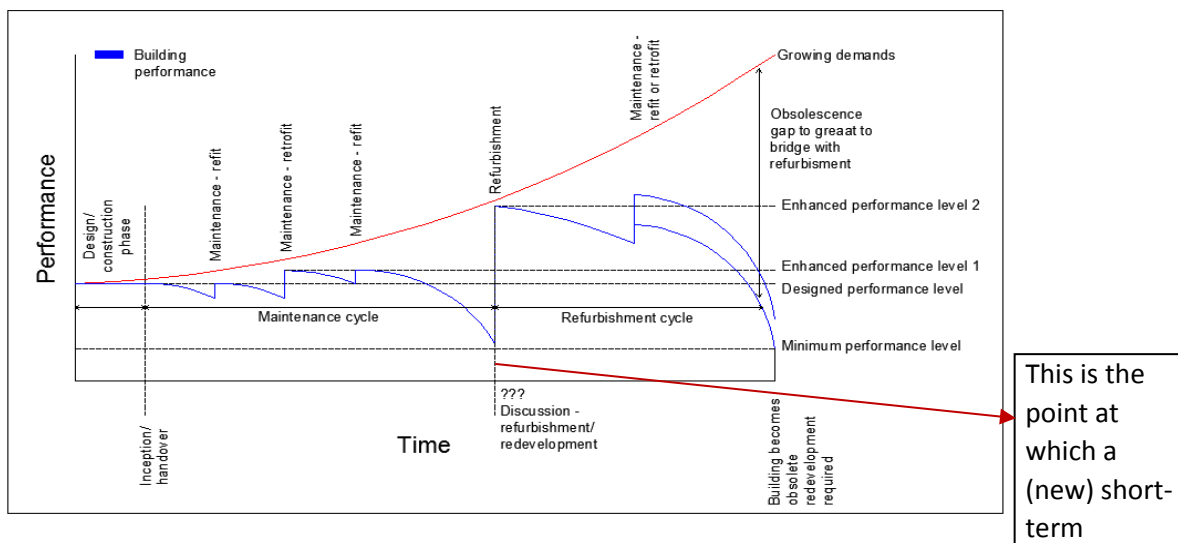

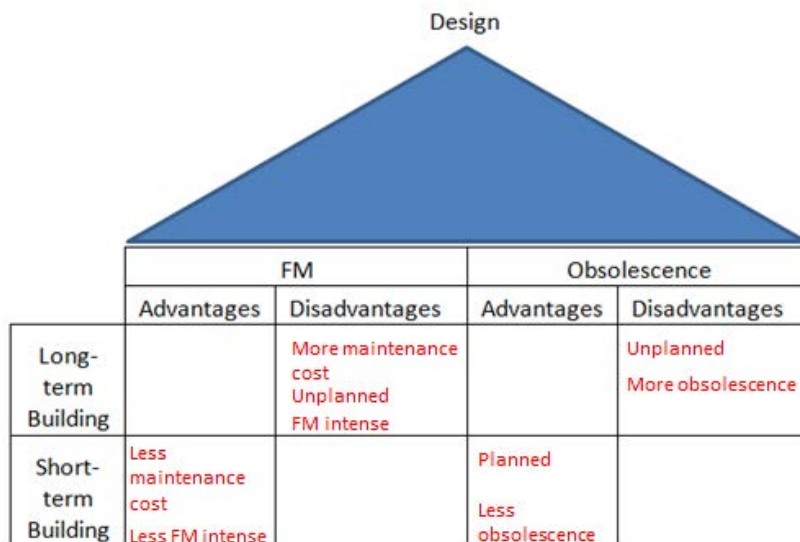

Figure 9: The Innovative, Trinity Conceptual Model

4. CASE STUDY OF AN ACADEMIC SETTING

George Thompson Building, which is a permanent, long-term, aging building of the University of Trinity Saint David (UWTSD – based at the Mount Pleasant Campus, Swansea, Wales), is selected as a case study. Given the brevity of the paper, though the whole building is considered in general, but features of Computer Lab 3, Room MG204 (on the 2nd floor) will be the particular focus. The case study is a real-world scenario of obsolescence requiring appreciation by both design and FM when dealing with and managing a permanent, long-term, and aging building in a modern-world. A qualitative approach is employed to illustrate that how various issues and problems of the building can be mapped on the triangular conceptual model. The study gathers primary data/information for subjective evaluation of elements of original design and that how these elements later manifest in the form of obsolescence and consequently impact on the FM.

The Building was constructed in the 1950s and officially opened in 1961. It was considered a building of modern architecture for its time. It is a concrete frame building with multiple storeys, large south facing single glazed, aluminium-framed, curtain wall sections and a flat roof. The building comprised drawing offices, classrooms, a library, common rooms, kitchen and dining facilities. Some of these facilities are still up and running in the building while others such as drawing offices and library do not exist any longer. Figure 10 shows how the building stands today.

Computer Lab 3 was converted from an old classroom facility in line with the technological advancements of the modern-world. The most obvious forms of obsolescence present are aesthetical, technological and functional. The room is worn-out and out-dated. Fixtures and fittings are damaged and broken, and the overall sense of ageing is quite apparent. A prime example can be identified in the curtain wall. The single glazed aluminium-framed sections, considered a modern design feature of its time, present a host of difficulties for FM. The paint finish has blistered and is coming away from the frame. These can be regarded as examples of aesthetical obsolescence. Did the design process consider what would be done by FM when such time as this will arrive? Probably not. Probably, the design even did not consider that how

would these windows will be cleaned externally. Nowadays, in view of CDM (Construction Design Management) Regulations 2015 in the UK, such matters are legally bound to be considered at the design stage.



Figure 10: Current, Front Elevation of the George Thompson Building of University of Wales Trinity St. David (UWTSD)

From the functional perspective, again quite a few types of obsolescence have been occurring, which again the design process did not and (in some cases) could not foresee, as it is not possible, at least not always, that what way the future would be like, be it near or distant. For instance, originally the room was for teaching as a typical classroom with blackboard and chalk. Back then computers were not a normal feature at all. Later, when the computational revolution hit the world full-on and computers became part of not only studies but every walk of life, the room was transformed into a computer lab. For this purpose, numerous computer cables had to be introduced and these were laid out in big conduits along the walls. Two walls contained windows all along. Not to mention these conduits also carried electric wires for all computers. Now these conduits come in the way of the windows and they can not be fully opened, but only partly, i.e. nearly 30 to 35%. While, specially during summer when it is hot (plus extreme heat waves due to climate change) and the computers emit additional heat, windows are most required to be fully opened. Also, the blinds technology which are easier to slide-open and also swivel-open, has also been introduced but these flag or wave with disturbing noise when it is windy and windows are open, so much so, that windows (some if not all) might have to be shut to avoid class / students disturbance. But then the accumulating heat in the room would lead to disturbance yet again.

The dropped ceiling has also been introduced for energy (cost) saving, fluorescent lighting and hiding pipes and vent systems, and probably also to enhance aesthetical look. But the problem is that the heating system is still old, and at times even during winter the room gets so hot that windows are needed to be opened, not to mention the additional heat of computers. This rather than saving on energy (cost), causes loss of energy. Additionally, industry standards have raised the level at which the curtain wall is expected to perform coupled with thermal challenges added by the change of use of the room, not to mention technological advancements and developments. On the other hand, the building was not designed to cater for such changes as these could not have possibly been foreseen or catered for at the design stage then. The result is a building product that is suffering major forms of aesthetical, functional, environmental and technological obsolescence which require major capital expenditure to update and upgrade.

It is not simply the curtain wall of the building and the room (under consideration) that is impacted by technological change. The room in its entirety is heavily impacted as explained with above with examples. The room was designed to set criteria relevant to the function it was to then carry out based on the available knowledge at the time. The original design has proved to be substantially inflexible as the change-of-use of the room (along with technological changes) has altered the total design criteria for the room. FM is left and had to be left on its devices to address these changes (without much help from the 'original' design). This also means that there is lack of design knowledge in FM and let alone the vice-versa. Acknowledging and integrating FM at the design stage will change the parameters of design at the outset thereby by enabling FM address the problems of obsolescence later on much more effectively. This would also help to render a building less FM intensive. However, on the contrary it was not possible to foresee all types and degrees of obsolescence in future.

This lack of foreseeability can be addressed by the innovative, triangular, conceptual model, if the building in question was a short-term rather than long-term as it has been, then it would have been a case of simply replacing it by a new, hi-tech, state-of-the-art, short-term building every time it reached the unacceptable level of obsolescence. This way the obsolescence would have been controlled probably more function-effectively and cost-effectively, and probably 'aesthetic-effectively' too. This also implies that financial obsolescence would have been automatically addressed or controlled and yet with less problems for FM. Another approach would be the concept of seeking a blend of permanent, long-term and temporary, modular, short-term buildings. For instance, the building could have been divided into two parts e.g. offices, etc. were placed in the long-term building part (like masonry) and class-rooms, laboratories, etc. in the short-term building part (like modular). This is being stated based on the presumption that generally offices like functions of the building would not be requiring as much upgradability as laboratories and classrooms. In this context, this presumption could help establish a kind of dividing line between long-term and short-term buildings leading to help find a balance between the two types.

5. CONCLUDING REMARKS

This paper signifies the distant relationship that exists between designing (or building designers) and FM (facility management or facilities managers), and yet the relationship is also mapped on obsolescence and its various types. The study concludes that the distant designer-FM relationship does not help at all to tackle obsolescence arising later in the life of a building. The matter is particularly, additionally serious due to the current, modern and fast-changing world. This is because obsolescence is not occurring merely on a typical wear and tear front, rather now on so many other aspects due to fast changes in technologies, legislation and regulations, health and safety, environment protection and enhancement pressures, consumerism – customer expectations, interests, standards and demands, etc.

The paper proposes an innovative conceptual model in which design, FM and obsolescence are introduced in a triangular relationship. The paper emphasises the fact that design can enable FM to manage and control all types of obsolescence if FM and obsolescence implications are considered at the design stage. The paper also appreciates that in the fast-changing modern-world, it may not be possible to appreciate all types of obsolescence and yet to full degree over time, let alone the complexities of varying combinations of obsolescence types. Therefore, one approach can be a mix-methods. That is, an appropriate blend of permanent, long-term and temporary, modular, short-term buildings – an optimal solution. This can lead to relatively

more cost-effective and less FM intensive solution. Furthermore, this may also satisfy the desire and affinity that humans have towards stone and brick work, long-term, permanent buildings as opposed to short-term, modular, temporary buildings. The paper also argues that short-term buildings need to be rendered more aesthetically sound (rather than merely be technologically and technically up to date) as long-term buildings generally are. This can help manage the 'long-term building affinity' of humans more effectively.

Long-term buildings increasingly struggle to sustain an acceptable level of performance against the growing demands. They are also immobile and exponentially become FM intensive over time. If not for domestic / residential buildings (due to affinity of humans with long-term buildings), then at least for commercial settings short-term buildings are the best way forward. Short-term buildings can greatly help FM to have more of planned and proactive maintenance and less of unplanned, reactive, and trouble-shooting maintenance. In addition, it is much easier to grapple with planned obsolescence as opposed to unplanned obsolescence. Furthermore, it is relatively easier to decide when to refurbish (enhance performance of a building) rather than only maintain the original design performance to the face of multi-changes of the modern-world. When such time as redevelopment arrives, a short-term building can more readily, conveniently, and cost-effectively be replaced, rather than a long-term, permanent building. The study appreciates that merely short-term buildings may not always be answer. Therefore, the study concludes that to the face of exponentially/accelerating technological change the mix of short-term with long-term design for planned obsolescence is increasingly becoming necessary.

In terms of future research, the paper brings out a number areas needing further investigation. Currently the case-study presented in the paper is subjective. Case studies with numerical data and objective analyses are needed to develop the proposed innovative, triangular conceptual model to its full potential. So that the model transforms into a methodology which is readily useable as an off-the-shelf tool by the building designer and facilities manager(s) together to control obsolescence with its all types in a proactive manner. Similarly, the implication of appropriate divide between planned and unplanned obsolescence as well as the suitable blend of long- and short-term buildings for various scenarios requires detailed studies. Influence of CDM and other building regulations on the model development and BIM (Building Information Modelling) potentials in connection to the model are also wide and deep areas needing great deal of research.

Note: The content of the paper reflects on views of the authors, and not necessarily that of their employer organisations.

6. REFERENCES

- Abramson, D. (2016). *Obsolescence: An Architectural History*, by Daniel M. Abramson. 1st ed. Chicago and London: University of Chicago Press.
- Alexander, K. (1996). *Facilities Management*. 1st ed. London: E & FN Spon.
- Allehaux, D. and Tessier, P. (2002). Evaluation of the Functional Obsolescence of Building Services in European Office Buildings. *Energy and Buildings*, 34(2), pp.127-133.
- Butt, T. E., Camilleri, M., Paul, P. and Jones, K. G. (2015). Obsolescence types and the built environment - definitions and implications. *International Journal of Environment and Sustainable Development*, 14(1), pp.20-39.
- Conejos, S., Langston, C. and Smith, J. (2015). Enhancing sustainability through designing for adaptive reuse from the outset. *Facilities*, 33(9/10), pp.531-552.
- de Oliveira, R. G. (2013), 'Planned Obsolescence', *Leadership & Management in Engineering*, 13(4) pp. 262-264.

- Douglas, J. (2006). *Building adaptation*. Amsterdam: Butterworth-Heinemann.
- Echegaray, F. (2016). Consumers' reactions to product obsolescence in emerging markets: the case of Brazil. *Journal of Cleaner Production*, 134, pp.191-203.
- Kamali, M. and Hewage, K. (2017). Development of performance criteria for sustainability evaluation of modular versus conventional construction methods. *Journal of Cleaner Production*, 142, pp.3592-3606.
- Lee, R. (1987). *Building Maintenance Management*. 3rd ed. Glasgow: William Collins Sons & Co.
- Lobonțiu, G. (2013). Planned Obsolescence and the Product Lifecycle. *Applied Mechanics and Materials*, 371, pp.857-861.
- RIBA (Royal Institute of British Architects), (2013). RIBA Plan of Works 2013. 1st ed. [ebook] London: RIBA. Available at: <https://www.ribaplanofwork.com/Download.aspx> [Accessed 18 Nov. 2016].
- SEAT. (2017). *The All-new Ibiza SEAT*. [online] Available at: http://www.seat.co.uk/new-cars/new-ibiza/overview.html?intcmp=new_ibz:new_ibz_carwld:hp_range [Accessed 13 Apr. 2017].
- Seeley, I. (1987). *Building maintenance*. 2nd ed. Basingstoke: Macmillan Press Ltd.
- Shen, Y. and Willems, S. (2014). Modeling sourcing strategies to mitigate part obsolescence. *European Journal of Operational Research*, 236(2), pp.522-533.
- Spedding, A. (1995). *CIOB handbook of facilities management*. 1st ed. Harlow: Longman Group Ltd.
- Stacchetti, E. and Stolyarov, D. (2015). Obsolescence of durable goods and optimal purchase timing. *Review of Economic Dynamics*, 18(4), pp.752-773.
- Then, D. and Hee, T. (2013). *Facilities management and the business of managing assets*. 1st ed. Oxon: Routledge.
- Thomsen, A, & van der Flier, K 2011, 'Understanding obsolescence: a conceptual model for buildings', *Building Research & Information*, 39, 4, pp. 352-362, Business Source Complete, EBSCOhost, viewed 15 November 2016
- Too, L., Harvey, M. and Too, E. (2010). Globalisation and Corporate Real Estate Strategies. *Journal of Corporate Real Estate*, 12(4), pp.234-248.
- Wernick. (2017a). *BAM Construction - Brynmor Jones Library - Wernick Hire Case Study*. [online] Available at: <https://www.wernick.co.uk/case-studies/hire/construction/bam-construction-brynmor-jones-library/> [Accessed 27 Apr. 2017].
- Wernick. (2017d). *Castleview School - Wernick Buildings Case Study*. [online] Available at: <https://www.wernick.co.uk/case-studies/buildings/education/castleview-school/> [Accessed 27 Apr. 2017].
- Wernick. (2017b). *Elephant & Castle - Wernick*. [online] Available at: <https://www.wernick.co.uk/case-studies/hire/construction/elephant-and-castle/> [Accessed 27 Apr. 2017].
- Wernick. (2017c). *The King's School - Wernick*. [online] Available at: <https://www.wernick.co.uk/case-studies/buildings/education/kings-school/> [Accessed 27 Apr. 2017].
- Wieser, H. (2016). Beyond Planned Obsolescence: Product Lifespans and the Challenges to a Circular Economy. *GAIA - Ecological Perspectives for Science and Society*, 25(3), pp.156-160.
- Wates Construction, (2015). *The Effects of Government Policy on University Estates Strategies*. [online] Surrey: Wates Construction. Available at: http://www.wates.co.uk/sites/all/modules/filemanager/files/Wates_Construction_University_Report.pdf [Accessed 15 Nov. 2016].
- Wood, B. (2003). *Building Care*. Oxford, UK: Blackwell Science.

AN IMPLEMENTATION STUDY OF TRANSFERRING PROJECT DATA FROM A BIM SOFTWARE TO A FM SOFTWARE VIA THE COBIE STANDARD

K. J. Tu and W. C. Chang

*Department of Architecture, National Taiwan University of Science and Technology,
43, Keelung Rd., Section 4, Taipei, 106, Taiwan*

Email: kjtu@mail.ntust.edu.tw

Abstract: The effective transfer of project data contained in the Building Information Model (BIM) of a constructed building to a facility management software adopted in its operational phase is a research topic needs further explorations. The COBie (Construction-Operations Building Information Exchange) standard is a plausible medium for the project data transfer between BIM software and FM software. The research objectives of this study are: (1) to implement the process of transferring project data from a BIM software (REVIT[®]) to a FM software (ArchiBus[®]) via the COBie standard in the case of the Da-Long-Dong (DLD) Public Housing Property in Taipei City; and (2) to assess the benefits of this approach that adopts the COBie standard as a project data transfer medium. This study has realized two benefits of the COBie approach in the DLD case: (1) it facilitates the data entry process in FM software: the percentages of the worksheet data of the four ArchiBus[®] modules that were filled in through data importation range from 3.9~41.0%. (2) it saves time in the data entry tasks in FM software: almost 20% of manual data entry time in the four ArchiBus[®] modules can be saved by direct data importation from the COBie standard worksheets.

Keywords: Benefits, Building Information Modelling, COBie Worksheet, Data Exchange, Facility Management.

1. INTRODUCTION

1.1 The problems

Building Information Modeling (BIM) has attained widespread attention in the architectural, engineering and construction (AEC) industry worldwide recently. In Taiwan, local governments have been trying to promote the applications of BIM in construction industry by demanding the architects and general contractors of public building projects to handover the BIM models of these projects to the owners at the end of their service terms. However, almost all BIM models handed over have failed to be further utilized during building operation and maintenance phase due to the following reasons (Chang, 2016):

1. High technical barriers in operating BIM software and extracting useful building information for the facility management staffs in the governments or the outsourced FM service providers;
2. Lack of research in the methods or demonstration cases in the applications of BIM in facility management;
3. Unclear about the benefits of BIM applications in facility management.

To create higher incentive for building owners to further apply BIM techniques in the operation and maintenance phase of their facilities, it is important that the methods, examples, and benefits of BIM applications in FM be exemplified and clarified.

1.2 COBie standard as a plausible solution

Various issues of BIM applications in FM have been addressed by several researchers. For examples, Teicholz (2013, p.10) has pointed out that one of the owner benefits of BIM and FM integration is that it 'streamlines handover and more effective use of data'. Despite these benefits, Sabol (2013) suggested that it is just the beginning to adopt BIM technology in FM and many challenges, such as standards for data exchange or integration of BIM software and FM software, are still lying ahead.

Since there are many BIM and FM software available in the market, the integration of both types of software is a great challenge. To react to this challenge, Teicholz (2013, p.8) reveals the need and four possible methods for data exchange or interoperability between systems:

1. Develop a spreadsheet to capture the equipment and related data needed for FM;
2. Use COBie (Construction Operation Building information exchange) standard format worksheets to capture building information contained in a BIM model and to export them into a FM software;
3. Utilize proprietary links between BIM software and FM software to create two-way links between them (such as EcoDomus);
4. Integrate a FM software with a BIM software using the BIM application programming interface (API).

This study argues that the COBie standard, an open and independent standard that specifies how all types of building and equipment data can be captured and what naming standards are appropriate for each kind of data, presents itself a plausible medium for data exchange between BIM software and FM software. In fact, East (2013) has described the spreadsheet format for COBie and the steps to implement COBie at a facility management office. Several COBie standard implementation cases in universities have also been reported, such as the Health Sciences Building on the Texas A&M campus (Beatty and Kim, 2013) and an administrative building on University of Chicago campus (Lewis, 2013). Nevertheless, more implementation cases and research effort on COBie standard are still needed for further explorations of its benefits, limitations, and research issues.

1.3 Research objectives

The research objectives of this study are: (1) to implement the process of transferring project data from a BIM software to a FM software via the COBie standard in the case of the Da-Long-Dong (DLD) Public Housing Property in Taipei City; and (2) to assess the benefits of this approach that adopts the COBie standard as a project data transfer medium.

2. LITERATURE REVIEW

The applications of BIM for FM have received global research interests. Yalcinkaya and Singh (2014) have investigated the benefits and the potential challenges of BIM for FM. Jensen and Johan (2013) suggest that BIM models of existing buildings be built (so called Slim BIM) as a good way to introduce BIM technology to the building industry. Important issues in implementing BIM for streamlining FM&O activities were discussed (Parsanezhad and Dimyadi, 2014). Methods and problems of open formats for transferring building information (e.g. IFC and COBie) were also addressed (East et al., 2013; Patacas et al., 2015).

The research issues specifically involved in transferring project data via the COBie standard in this study include data exchange between (1) BIM software and COBie standard, and (2) between COBie standard and FM software. Review of the latest literature are summarized.

2.1 Data exchange between BIM software and COBie standard

Before data of a BIM model are exported from a BIM software, it is important to first inspect the procedures taken to construct the BIM model as well as the resulting data quality. Zadeh et al. (2015) proposed a set of checklists to be used to inspect the constructed BIM model to ensure that standardization of BIM model building and data quality are achieved. The next issue is to identify and adopt a commonly accepted standardized file format which can ensure data of a BIM model are not lost during data exportation and transfer (Howard and Bjork, 2008). Currently, there are two standardized file formats commonly adopted under different circumstances: (1) ifc (industry foundation class) whose data structure is more complicated, but building data more complete (Redmond et al., 2012); (2) XML file format whose data structure is simpler, but provides less functions (Dong et al., 2007).

COBie is an international standard that delivers managed asset information. The COBie standard organizes building data in a series of related worksheets, which together create a database for a building describing its facilities set (East, 2013). Recognizing the importance of COBie standard, many BIM software have supported COBie and are able to export COBie standard worksheet data (East, 2017).

2.2 Data exchange between COBie standard and FM software

Building owners may adopt FM software offering a variety of facility management modules or functions to facilitate FM tasks in their facilities. Quite a lot of data need to be input into the FM software before the software can be functional. Importing data in COBie standard worksheets directly into FM software could facilitate the data entry process.

COBie standard is meant to deliver building data to facility managers. In fact, many FM software, as shown on the website 'buildingSMART alliance information exchanges: Means and Methods' (East, 2017), support COBie standard and are able to import all or part of the COBie data set. Nevertheless, East (2103) has pointed out that the ability of FM software to consume COBie data is very important and suggested that internal software testing be performed to evaluate the applicability of the COBie standard to a particular FM software.

3. 'COBIE STANDARD' AS A PROJECT DATA TRANSFER MEDIUM

To extend the effective utilization of the project data established in the BIM model of a building into its operation and maintenance phase, this study proposes an approach that adopts the 'COBie standard' as a project data transfer medium, in order to transfer project data contained in the BIM model into certain facility management software. The concepts and logic underlying this approach are:

1. BIM software and database: BIM software (such as REVIT® or ARCHICAD®) typically store the geometric and non-geometric building information of individual components of a building in a database. These software are able to export ifc files containing neutral data

models for data exchange across different BIM platforms. The ifc files can then be exported and saved as a worksheet file following the COBie standard format (Figure 1a). BIM and FM software are often not compatible, and the data stored in BIM software may not be imported directly into the FM software. The capability of BIM software to export files following COBie standard makes it a feasible project data transfer medium.

2. COBie standard worksheets: This study intends to adopt the UK COBie standard BS 1192-4 (British Standards Institution, 2014) which has devised 18 COBie standard worksheets to describe or record a building from 18 categories, such as *Instruction, Contact, Facility, Floor, Space, Zone, Type, Component, System, Assembly, Connection, Spare, Resource, Job, Impact, Document, Attribute and Coordinate* (Figure 1b, Figure 2). Data in a BIM model will be first exported as a spreadsheet file following the UK COBie standard format, and then imported into a FM software.

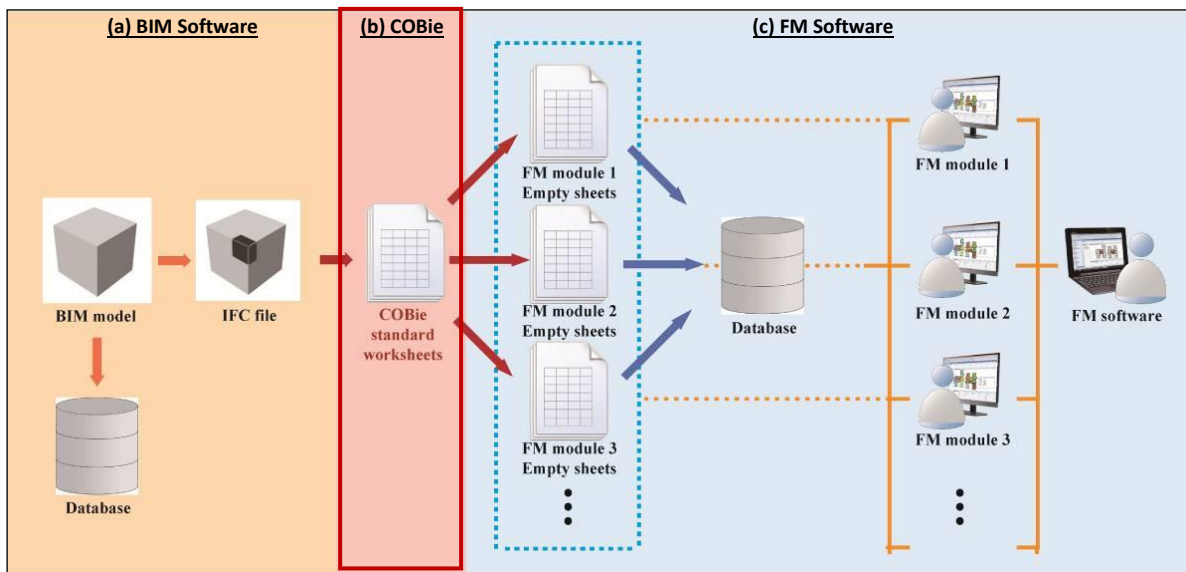

Figure 1: The process of transferring project data between BIM and FM software by adopting the COBie standard as a medium.

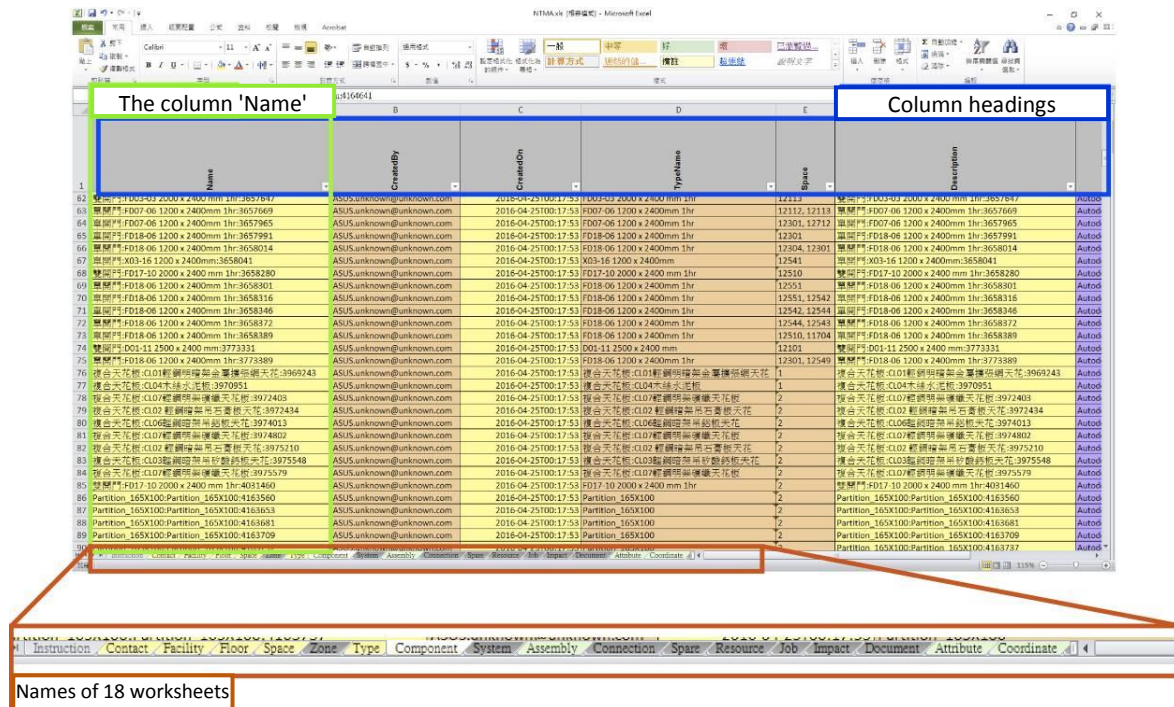

Figure 2: Exported UK COBie standard worksheets and the names of 18 worksheets.

3. FM software and database: FM software (such as ArchiBus® or Maximo®) offer various facility management modules to facilitate the operation and maintenance of facilities. To make these FM modules functional, FM staffs need to first input data manually through certain user interfaces which are then stored in a database. Alternatively, the data required by each FM module can be considered as several empty sheets to be filled in with data (Figure 1c). This study will first correspond the data structure of COBie standard worksheets and FM module empty sheets, then copy or import the project data contained in COBie standard worksheets directly into the FM module empty sheets.

4. IMPLEMENTATION RESEARCH METHODS

The authors of this study have been concerned about the facility management of public housing in Taiwan. The Da-Long Dong (DLD) Public Housing Property owned by the Taipei City is selected as a subject case in this study, for the following reasons, to implement the process of transferring project data from its BIM model to a facility management software:

1. Taipei City Government has been developing newer generation public housing in recent years and requested the general contractors to submit BIM models of the built public housing. However, most of these public housing projects are not yet in operation whose BIM models are not available.
2. The DLD is the only newer generation public housing property that was constructed and in operation in Taipei City, and the authors have known its operation and facility management well and were provided with supporting documents (drawings, data).
3. The authors had the BIM and FM software, manpower, and supporting documents to initiate a research effort themselves to explore the implementation process of data transfer between the BIM and FM software via the COBie standard in the DLD property.

4.1 The subject - The Da-Long Dong (DLD) public housing property in Taipei City

The DLD Public Housing Property has been in operation since January 2011. The site area is 2,600m², on which two apartment buildings (eleven floors above ground and three below) are placed (Figure 3a). The total floor area is 16,423m². The DLD offers a total of 110 apartment units (1BR 30 units [A4, B2, B5 in Figure 3b]; 3BR 80 units [the other eight units in Figure 3b]) and 5 retail units (on the first floor along the 40m major road Cheng-Der Rd.) for rent. It also provides a total of 89 car parking spaces and 208 motorcycle parking spaces on the first floor and three basement floors.

4.2 The BIM and FM software

The Taipei City Government has not built any BIM model for the DLD property, and has not adopted any facility management software since its operation in 2011. In order to conduct the case study of the project data transfer process, this study adopted the following two software:

1. BIM software: Autodesk REVIT[®] 2014 was used to build the BIM model for the DLD property by this study. For case study and implementation purposes, this study did not construct a complete BIM model for the whole DLD property, but the following portions of the building and building systems in LOD (level of details) 200~300:
 - Building structure: B2~3F (Figure 2)
 - Building envelope: B2~3F (Figure 2)
 - Lighting system: B2~3F
 - Apartment units and spaces: B2~3F (Figure 2)
 - Bathroom equipment: B2~3F
 - Plumbing system: Cold water supply system on the first floor
 - Fire safety system: B2~3F
 - Electrical system: Uninterrupted power supply (UPS) on B2
 - Doors and windows: 3F



(a) Site plan of the DLD Public Housing Property



(b) Typical floor plan of the DLD Public Housing Property
 Figure 3: The architectural design of the DLD Public Housing Property

2. FM software: ArchiBus® V.19, consisting of a web-central module and 2D-drawing based interface, a centralized database and the following four functional modules, was adopted for the operational and maintenance management in the DLD property:
 - *Space management*: consisting of 20 functions for the management of private spaces (apartment units) and public spaces (lobby, common facilities, parking, mechanical rooms, and FM logistic spaces) in the DLD property;
 - *Asset management*: consisting of 11 functions for the management of individual major MEP building systems and equipments in the DLD property;
 - *Preventive maintenance*: consisting of 48 functions for the planning of preventive maintenance schedules of major MEP building systems and equipment in the DLD property, as well as the executions of preventive maintenance plans;
 - *Leasing*: consisting of 16 functions for the management of leasing related tasks (rental spaces, tenants, contracts, rents and income, etc.) in the DLD property.

4.3 The process of project data transfer via the COBie standard

To implement the transfer of DLD project data from its BIM model to the ArchiBus® FM software via the COBie standard, this study has conducted the following tasks (Figure 4):

- Step 1: Inspect the building information contained in the DLD BIM model;
- Step 2: Export DLD project data in BIM model into COBie standard worksheets;
- Step 3: Import COBie worksheet data to the ArchiBus® database;
- Step 4: Input additional required data to the ArchiBus® database;
- Step 5: Assess the benefits and issues observed in this implementation study.

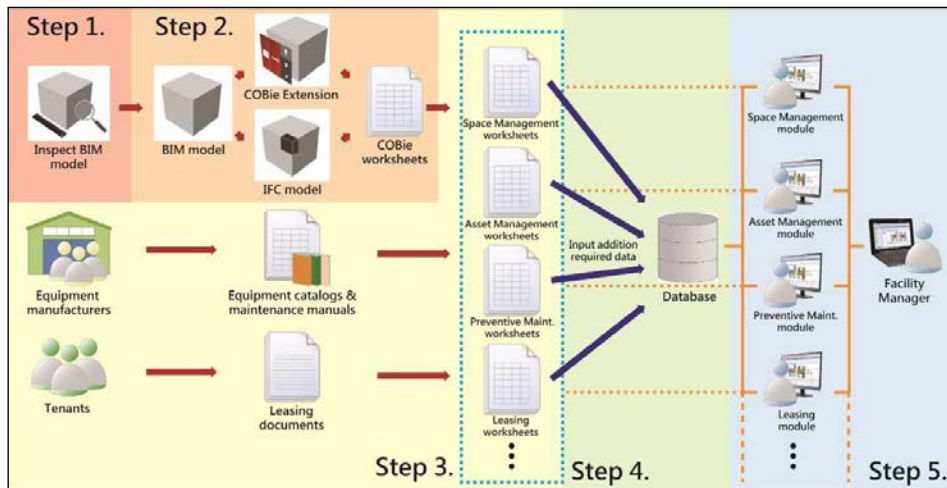

Figure 4: The five-step process for transferring project data via the COBie standard.

5. IMPLEMENTATION STUDY RESULTS

The implementation results of individual steps of project data transfer via the COBie standard are reported step by step in the following sections.

5.1 Inspect building information in DLD BIM model

Before exporting project data in the DLD BIM model, this study conducted the following inspections on the building information contained in the BIM model to make sure that the building information are correct in their data definitions, data values, data format, and data correspondence with the COBie standard format:

1. Inspect to ascertain the BIM model information of individual building systems are input by responsible professionals (such as architect, structural engineer, mechanical and electrical engineer, etc.);
2. Inspect to ascertain that the project data in the DLD BIM model correspond to certain data columns in the COBie standard worksheets;
3. Inspect to ascertain that the DLD BIM model is categorized into individual building systems and components with certain functions, so that the BIM model meets the management and maintenance requirements in the ArchiBus[®] software;
4. Inspect to ascertain that the namings of building systems and components in the BIM model are logical and comprehensible so that project data exported to COBie standard worksheets are understandable;
5. Inspect to ascertain the LODs (level of details) of the building systems and components in the DLD BIM model meet the data requirements of the ArchiBus[®] software.

5.2 Export DLD project data in BIM model into COBie standard worksheets

The following two steps were taken by this study to export the DLD project data contained in its BIM model into COBie standard worksheets:

1. In REVIT[®]: 'Open' the DLD BIM model file > select 'Export' function > select 'ifc' format > to export an DLD ifc file (Figure 5a);

- In xBIM freeware: 'Open' the DLD ifc file > select 'Export' function > select 'COBie' format > to transfer into the COBie standard worksheets (Figure 5b).

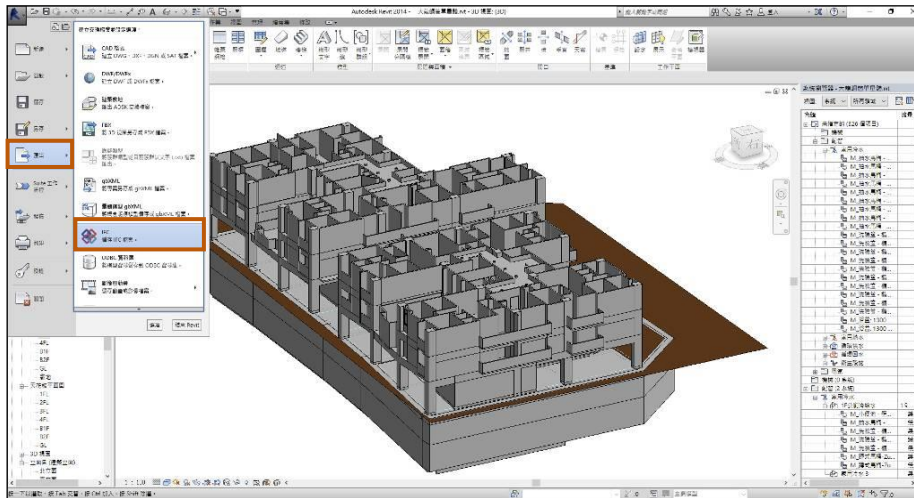

(a) The user interface and functions that export an ifc file in REVIT®.

Title	Revision	Release	Status	Region	Purpose	Dates	All Phases	Contact	Daily Design Worksheets	Facility	Floor	Space	Type	Detailed Design Worksheets	Component	System	Assembly	Connection	Impact	Construction Worksheets	Operations and Maintenance	Spare	Resources	IRI
COBie						1900-01-001000000																		
						2016-04-1610307-48																		
						2016-04-1610307-48																		
						2016-04-1619327-48																		
						2016-04-1619327-48																		
						1900-01-001000000																		
						2016-04-1619327-48																		
						2016-04-1619327-48																		
						1900-01-001000000																		
						2016-04-1619327-48																		
						2016-04-1619327-48																		
						1900-01-001000000																		
						2016-04-1619327-48																		
						2016-04-1619327-48																		
						1900-01-001000000																		

(b) The resulting COBie standard worksheets exported from the xBIM freeware.
Figure 5: Exporting DLD project data in BIM model to COBie standard worksheets.

5.3 Import COBie worksheet data to the ArchiBus® database

In ArchiBus®, this study conducted certain tasks to import DLD project data stored in the COBie standard worksheets into the following four FM modules:

- In the 'Space Management' module: Export the 11 empty worksheets to be filled in data; copy corresponding data in the COBie worksheets to 'Space Management' empty worksheets column by column (Figure 6a).
- In the 'Asset Management' module: Similarly, export the eight empty worksheets and copy corresponding data in COBie worksheets to these empty worksheets.
- In the 'Preventive Maintenance' module: Similarly, export the 20 empty worksheets and copy corresponding data in COBie worksheets to these empty worksheets.
- In the 'Leasing' module: Similarly, export the two empty worksheets and copy corresponding data in COBie worksheets to these empty worksheets.
- Import the data filled in ArchiBus® worksheets into ArchiBus® database (Figure 6b).

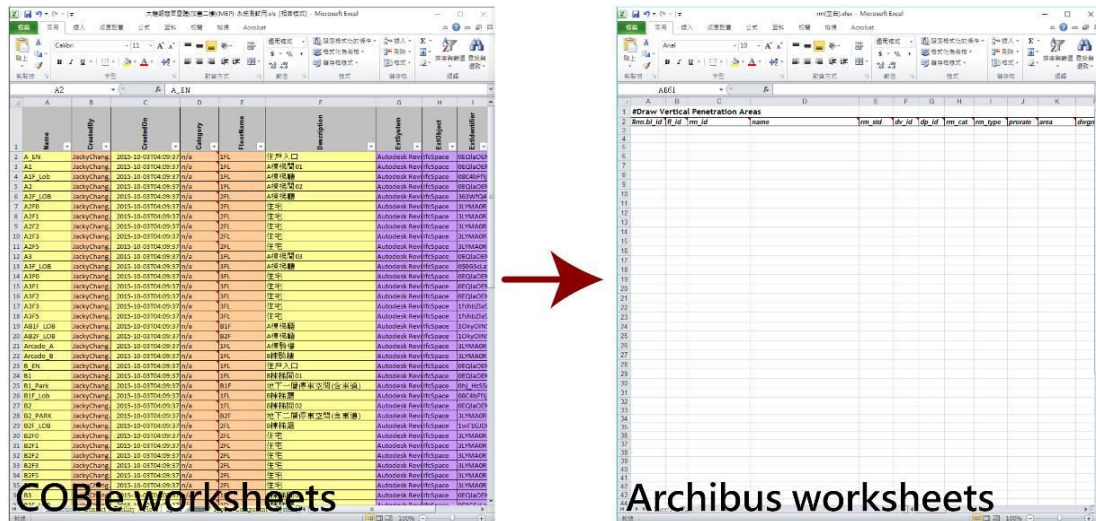

(a) Copying data stored in COBie standard worksheets to corresponding Archibus® worksheets.

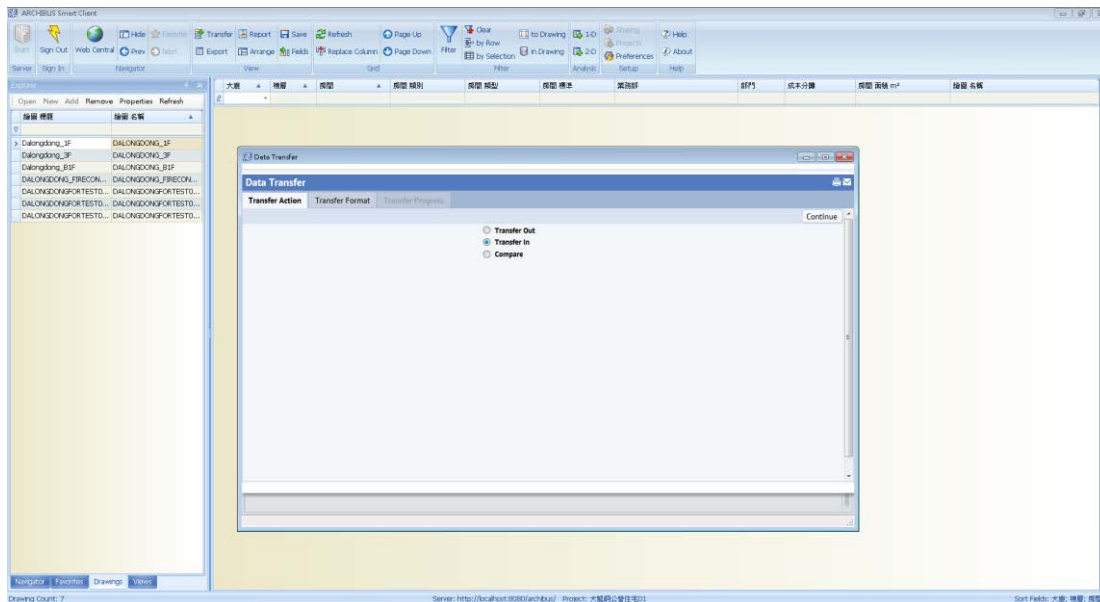

(b) The function of importing filled Archibus® worksheet data into Archibus® database.

Figure 6: Importing COBie worksheet data to the Archibus® database.

5.4 Input additional required data to the Archibus® database

Not all the data in the empty worksheets of four modules can be filled in by copying project data from the COBie standard worksheets. Therefore, additional required data for each FM module were input manually through the Archibus® interface by this study in order to make those four FM modules functional and operational (Figure 7).

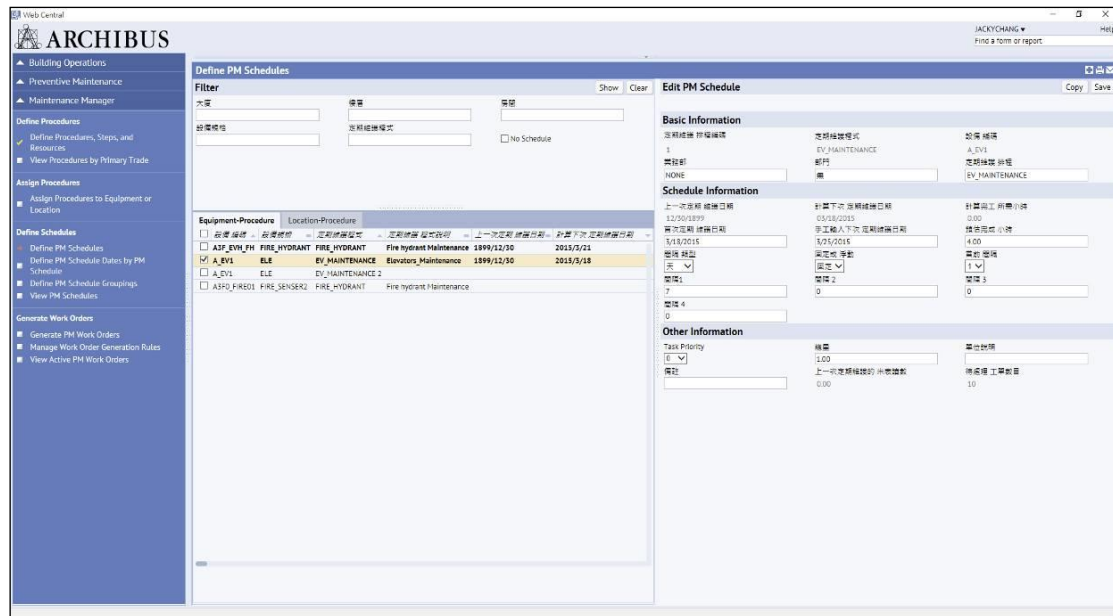

Figure 7: The data entry interface of the 'Preventive Maintenance' module in ArchiBus®.

5.5 The benefits and discussions

When the ArchiBus FM software is adopted in a certain property or facility, all data required by certain ArchiBus FM modules need to be input manually, which may take several months to complete in this conventional approach (without importing project data from BIM model). After implementing the transfer of DLD project data via the COBie standard format, this study has realized some benefits from this alternative approach:

1. It facilitates the data entry process in FM software: in the DLD case, certain percentages of project data established in the BIM model were useful to the ArchiBus software and transferred via the COBie standard worksheets to the empty worksheets of FM modules:
 - *Space Management* Module: 29 out of 224 columns (13.0%) of worksheet data were filled in through data importation;
 - *Asset Management* Module: 84 out of 205 columns (41.0%) of worksheet data were filled in through data importation;
 - *Preventive Maintenance* Module: 6 out of 155 columns (3.9%) of worksheet data were filled in through data importation;
 - *Leasing* Module: 8 out of 64 columns (12.5%) of worksheet data were filled in through data importation.
2. It saves time in the data entry tasks in FM software: in the DLD case, a total of 127 out of 648 columns (19.6%) of project data required by the four ArchiBus FM modules can be transferred successfully. In other words, almost 20% of data input time can be saved by adopting the BIM and COBie standard data transfer approach. Potentially, more project data input time can be saved in larger projects.

Through the exercise and implementation of project data transfer between the BIM and FM software, this study found the followings worth noting:

1. The project data in the BIM model established during the design and construction phases are often more related to 'space' and 'building system/components'. Thus, more benefits can be gained when transferring project data to related FM modules such as '*Space Management*' and '*Asset Management*'.

2. This study has quantified the percentages of the worksheet data of the four FM modules that could be filled in through data importation which range from 3.9~41.0%. Although the percentage for certain FM module (such as *Preventive Maintenance*) may seem low, it should not be concluded that transferring project data from BIM models is an inefficient practice. In fact, it should be noted that the data stored in the BIM model of a building are mostly 'static data' (of spaces and building objects); whereas the data required by the FM software are more 'task oriented' which are often not available until the FM plans are specified in the beginning of operational and maintenance phase.
3. Although BIM FM integration are still limited in current practice, it's worth mentioning other benefits of BIM and FM integration during the life of the building (than the benefit of 'streamline handover and more effective use of data' discussed in this study), such as improved workforce efficiency, reduced cost of utilities, reduction in equipment failures, improved inventory management, better building enhancement plans resulted from updated and accurate building records, etc., as revealed by Teicholz (2013, p.10-15).

6. CONCLUSIONS

This study has adopted the COBie standard as a project data transfer medium, and implement the process of transferring project data from a BIM software (REVIT[®]) to a FM software (ArchiBus[®], consisting of four FM modules, i.e. *Space Management*, *Asset Management*, *Preventive Maintenance* and *Leasing*) via the COBie standard in the case of Da-Long-Dong DLD) Public Housing Property in Taipei City. The implementation process consists of five steps: (1) inspect the building information contained in the DLD BIM model; (2) export DLD project data in BIM model into COBie standard worksheets; (3) import COBie worksheet data to the ArchiBus[®] database; (4) input additional required data to the ArchiBus[®] database; and (5) assess the benefits and issues observed in this implementation study.

After the implementation, this study realizes the following two benefits of the COBie data transfer approach: (1) it facilitates the data entry process in FM software: in the case of DLD, the percentages of the worksheet data of the four FM modules that could be filled in through data importation range from 3.9~41.0%. (2) it saves time in the data entry tasks in FM software: in the DLD case, almost 20% of manual data entry time in the four FM modules could be saved by direct data importation via the COBie standard.

Due to time constraint, this study did not establish a complete BIM model for the whole DLD Public Housing Property; and the benefits of the COBie standard data transfer approach were assessed from the perspective of the percentage and number of columns in the ArchiBus data worksheets that can be filled in through data importation. To objectively measure the benefits of the COBie standard data transfer approach, this study suggests that future research be conducted to (1) build the full BIM model of the DLD property, and (2) to measure and compare the time taken by the manual data entry approach as well as the COBie standard data transfer approach to input data into the four FM modules in ArchiBus[®], in order to assess the actual amount of time that can be saved through the COBie standard data transfer approach.

7. ACKNOWLEDGEMENT

The authors thank the Ministry of Science and Technology of the Executive Yuan of Taiwan for sponsoring this research work (Project No. MOST 103-2221-E-011 -084 -MY2).

8. REFERENCES

- Beatty, B. and Kim, K. (2013). Case Study 2: Texas A&M Health Science Center - A Case Study of BIM and COBie for Facility Management. In P. Teicholz, ed., *BIM for Facility Managers*. 1st ed. New Jersey: John Wiley & Sons, Inc., p. 107-143.
- British Standards Institution (2014). *Collaborative production of information - Part4: Fulfilling employer's information exchange requirements using COBie - Code of practice*. BSI Standards Publication.
- Chang, W.C., 2016, *Utilizing BIM and COBie in the facility management of building-The case of Da Long Dong Public Housing*, M.S., Department of Architecture, National Taiwan University of Science and Technology, Taipei, Taiwan.
- Dong, B., Lam, K.P., Huang, Y.C., Dobbs, G M, (2007). A Comparative Study of the IFC and gbXML Informational Infrastructures for Data Exchange in Computational Design Support Environments. Proceedings: Building Simulation, Beijing, China, September 3-6, 2007. p. 1530-1537.
- East, B. (2017). *buildingSMART alliance information exchanges: Means and Methods*. [online] Available at: https://www.nibs.org/?page=bsa_cobiemm [Accessed 15 June 2017].
- East, B. (2013). Using COBie. In P. Teicholz, ed., *BIM for Facility Managers*. 1st ed. New Jersey: John Wiley & Sons, Inc., p. 107-143.
- East, E.W., Nisbet, N and Liebich, T. (2013). Facility Management Handover Model View, *Journal of Computing in Civil Engineering*, 27(1), p.61-67.
- Howard, R. and Bjork, B.-C. (2008). Building Information Modelling – Experts' Views on Standardisation and Industry Deployment. *Advanced Engineering Informatics*, 22, p. 271–280.
- Jensen, P.A. and Jóhannesson, E.I. (2013). Building information modelling in Denmark and Iceland, *Engineering, Construction and Architectural Management*, 20 (1), p.99-110.
- Kensek, K. (2015). BIM Guidelines Inform Facilities Management Databases: A Case Study over Time. *Buildings*, 5, p. 899-916.
- Lewis, A. (2013). Case Study 6: University of Chicago Administration Building Renovation. In P. Teicholz, ed., *BIM for Facility Managers*. 1st ed. New Jersey: John Wiley & Sons, Inc., p. 107-143.
- Parsanezhad, P. and Dimyadi, J. (2014). Effective Facility Management and Operations via a BIM-Based Integrated Information System. CIB Facilities Management Conference - Using Facilities in an Open World Creating Value for all Stakeholders, 21-23 May, 2014, Copenhagen, Denmark.. P. 442-453.
- Patacas, J., Dawood, N., Vukovic, V. and Kassem, M. (2015). BIM for Facilities Management: Evaluating BIM Standards in Asset Register Creation and Service Life Planning. *Journal of Information Technology in Construction*, 20, p. 313-331.
- Redmond, A., Hore, A., Alshawi, M., West, R. (2012). Exploring how information exchanges can be enhanced through cloud BIM. *Automation in construction*, 24, p. 175–183.
- Sabol, L. (2013). BIM Technology for FM. In P. Teicholz, ed., *BIM for Facility Managers*. 1st ed. New Jersey: John Wiley & Sons, Inc., p. 17-45.
- Teicholz, P. (2013). Introduction. In P. Teicholz, ed., *BIM for Facility Managers*. 1st ed. New Jersey: John Wiley & Sons, Inc., p. 1-13.
- Yalcinkaya, M. and Singh, V. (2014). Building Information Modelling (BIM) for Facilities Management – Literature Review and Future Needs. *11th IFIP International Conference on Product Lifecycle Management*, July 7-9, 2014, Yokohama, Japan. p. 1-10.
- Zadeh, P. A., Sheryl S.-F., Pottinger, R., (2015). Review of BIM Quality Assessment Approaches for Facility Management. *5th International/11th Construction Specialty Conference*, Vancouver, British Columbia, June 8-10, 2015. p. 342-1 – 342-10.

RAILWAY NETWORK RELIABILITY ANALYSIS BASED ON KEY STATION IDENTIFICATION USING COMPLEX NETWORK THEORY: A REAL-WORLD CASE STUDY OF HIGH-SPEED RAIL NETWORK

Li Wang^{1,*}, Min An^{2,*}, Yinggui Zhang³, Khan Rana²

¹ School of Traffic and Transportation, Beijing Jiaotong University, Beijing, 100044, China

² School of the Built Environment, University of Salford, Manchester, M5 4WT, UK

³ School of Traffic and Transportation Engineering, Central South University, Changsha, 410075, China

Email: Wangli@bjtu.edu.cn; M.An@salford.ac.uk

Abstract: The railway infrastructures have been rapidly developed around the world in the recent years. As a consequence, topology structures and operation modes of the railway network are greatly changed to very complicated network systems. Reliability analysis of a railway network combining topology structures with operation functions will help to optimize the railway network infrastructures. This paper presents a new reliability analysis method of the railway network, combining the physical topology with operation strategies. Firstly, two network models of railway physical network and train flow network are proposed. Then key stations identification indexes can be gained from such two network models, which include degree, strength, betweenness clustering coefficient and a comprehensive index. Given the key stations, railway network efficiency can be analysed under selective and random modes of the stations failure. A real-world case study of the high-speed railway network in China is presented to demonstrate the key stations playing an important role in improving the whole network reliability. In the end, some recommendations are given to improve the network reliability. The proposed method can provide useful information to railway developers, designers and engineers in the railway infrastructure projects for sustainable development.

Keywords: Complex Network, Key Stations, Railway Network Infrastructure, Reliability Analysis, Train Flow Network

1. INTRODUCTION

The railway infrastructures have been rapidly developed around the world in the recent years. The total length of the railway network in the world is more than 1,370,000km and the high-speed railway is 29,792km by 1 April 2015 (UIC, 2015). With the continuous construction and development of the railway system, the temporal and spatial dynamics of the network and the organization relationship between the rail lines are getting stronger. Due to the rapid increase, operation and maintenance of the whole railway network are becoming more difficult. The trains traveling bring more complex relationship between the stations. If there is a failure at the key station, it would decline the transportation efficiency of the whole network. Therefore, identifying the key stations and analysing the reliability of the network is one of the most important things in the railway development. Since the railway network is a complex system with lots of stations and tracks and operation correlation, it can be analysed based on complex network theory. Therefore, the reliability analysis is becoming more important to ensure the safe operation. This paper proposes a new method to analyse the reliability of railway network based on the key station identification and efficiency evaluation of the network in different failure modes of the stations, which will help to provide comprehensive suggestions for the infrastructure planning and transportation operations.

Many researchers have found that there are many complex networks in the real world, such as biology network (Zenil et al, 2014), Internet (Zquez et al, 2002), research cooperating network (Yin et al, 2006, Koseoglu, 2016), electricity system (Chassin et al, 2005) and traffic network (An et al, 2014, Meng et al, 2015). Furthermore, based on the complex network theory, a lot of empirical studies show that some transportation system infrastructure topologies have exponential degree distributions, such as Chinese bus-transport systems (Xu et al, 2007), Indian railway system (Sen et al, 2003), urban street networks (Porta et al, 2006, Wang et al, 2017), Indian airline network (Bagler, 2008) and USA airline network (Dall'Asta et al, 2006). They all have the small-world network or scale-free network characteristic. In addition, complex network theory has also been applied to the research of the safety and reliability of some complex systems (Zio and Sansavini, 2011, Dey, 2016). Furthermore, their research established various network models and studied the structural characters by the system indicators, which includes nodes degree, average path length, clustering coefficient etc. Some researchers described the complex system vulnerability by cascading failures theory under random or selective node failure modes (Buldyrev et al, 2010, Ren et al, 2016, Yan, 2014, Wilkinson, 2017). While some researchers developed reliability analysing methods for the transportation systems.

Guidotti et al (2017) proposed a probabilistic methodology to quantify the network reliability based on existing (diameter and efficiency) and new (eccentricity and heterogeneity) measures of connectivity and was applied to a highway transportation network. Qian et al (2015) proposed a cascading failure model of the complex network to simulate the road traffic states using different time delays, incident dissipation factor and load capacity. Chen et al (2014) presented a directed chaos mutation sorted discrete PSO algorithm to optimize the invulnerability of Chinese railway traffic network by adding edges to the network. Lin et al (2016) and Li et al (2015) treated high-speed train as a complex system accompanied by a lot of components and connections, and studied the safety and reliability based on complex network theory. Ouyang et al (2014) applied complex network to study the performance and vulnerability of Chinese railway under various types of attacks and hazards.

Although, the complex network theory was widely developed in the reliability analysis of the complex system, however these studies limited to the physical topological properties, the railway operation functions are neglected. The aim of this paper is to present a new method to analyse the reliability of the railway network by identification of the key stations. Not only the physical network topology, such as degree and clustering coefficient, but also the dynamic operation parameters, such as train running paths, stop-schedules and service frequencies, are considered in this method. Given the key stations, railway network efficiency is analysed under random and selective modes of the station failure, and demonstrates the key stations playing an important role in improving the whole network reliability.

This paper is organised into the following sections. Section 2 proposes the reliability analysis method of railway network based on key stations identification and network efficiency using network complex theory. In section 3, a case study of the high-speed railway network in China illustrates the proposed method. Section 4 presents some recommendations in terms of infrastructure planning and transportation operation of in order to satisfy the safety and economic development in the future. Section 5 gives the conclusions.

2. RELIABILITY ANALYSIS METHOD

In this section, a new reliability analysis method of the railway network is proposed combining the infrastructure topology structure with operation function. It includes three main stages, railway network models, key station identification indexes and network efficiency analysis under random and selective modes of nodes failure as shown in Fig.1. In the railway network models, railway physical network (RPN) that has been further developed on the basis of Guidotti et al (2017) and Meng et al (2015), and a train flow network (TFN) of a service plan can be then obtained by integrating RPN in taking operation strategies into consideration, for example, train running routes, stop-schedules and service frequencies as stated in section 1. Afterwards, key station identification indices are used to evaluate the nodes of TFN, which provided the rank of the stations. Finally, network efficiency analysis is simulated by the selective and random station failure.

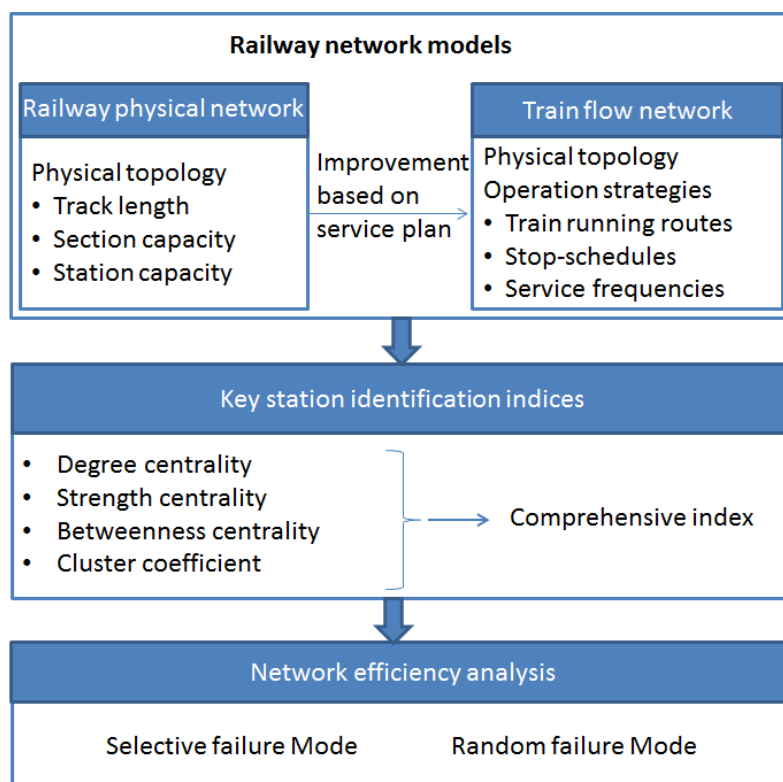

Figure 1: Reliability analysis process

2.1. Railway network model

Two models, railway physical network and train flow network are proposed in this section. The former shows the physical connecting properties and provides constraints to the train flow network, whereas, the latter shows train service plan and the operation properties of railway physical network, which improved railway physical networks.

Railway physical network (RPN): The stations are regarded as nodes and the connecting tracks between any two stations are regarded as edges based on the network theory (Xu et al. 2007; Wang et al. 2017; Bagler 2008; Dey 2016). Thus, the RPN can be represented as undirected graph $G_g=(V_g, E_g)$, where V_g is the railway station set, and E_g is the rail track set. The RPN shows the physical connectivity between the stations. Furthermore, the track length, section

capacity and station capacity can be added to the network, hence, the RPN can carry the transportation capacity constraints for train service plan.

Train flow network (TFN): As the stations are regarded as nodes, therefore, if a train stops at two stations, there will be one edge between them. The number of trains' stop at two stations is defined as the weight of the edge (Meng et al 2015). Based on this definition, there will be 6 edges if one train stops at 4 stations. Thus, the TFN can be represented as undirected graph $G=(V_t, E_t)$, where V_t is the station set where any train can stop at, and E_t is the edge set that created by any two stops at any station of all trains. According to the definition, the TFN can be established according to train service plan, in which the stop-schedules can create the nodes and edges, and trains' frequencies decide the weights of edges.

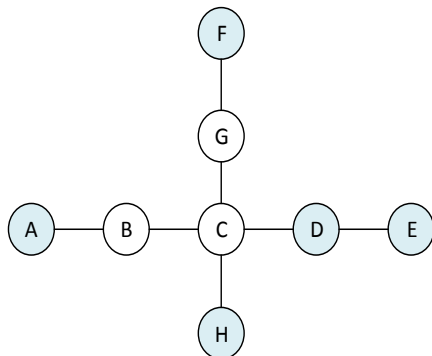

Figure 2(a): Railway physical network

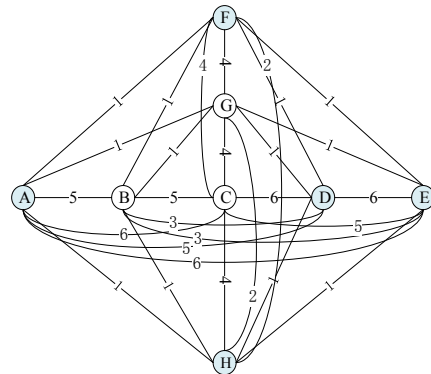

Figure 2(b): Train flow network

Figure 2: Railway networks

According to the proposed models, the RPN can be improved to a TFN by including the train service plan. A simple case of two rail lines for the two network models is given in Fig.2. Fig.2 (a) represents two rail lines in the RPN. One includes 5 stations marked as A, B, C, D and E, and the other includes 4 stations marked as F, G, C and H. The station C is a junction, and the blue nodes mean terminal stations that can be starts and ends of the trains. While, Fig.2 (b) shows the TFN that is developed by adding train service plan to the RPN, whereas the service plan is shown in Fig. 3.

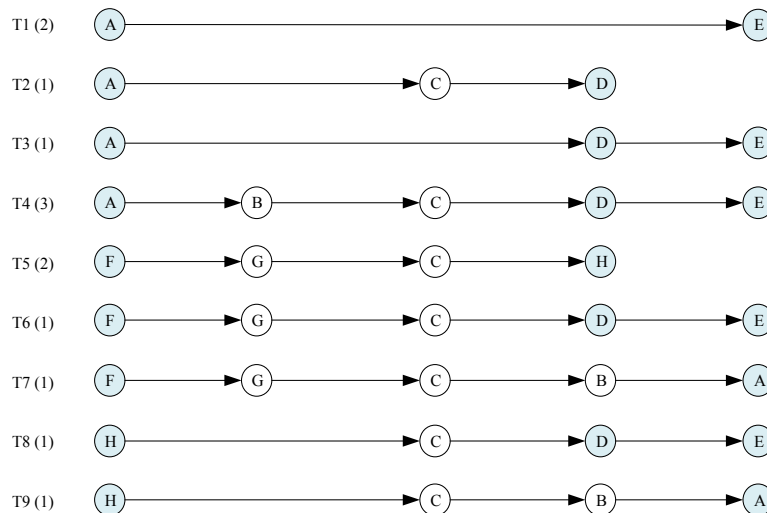

Figure 3: Train service plan

As shown in Fig.3, the train service plan includes 9 stop-schedules marked from T1 to T9, and their frequencies are 2, 1, 1, 3, 2, 1, 1, 1 and 1 respectively (shown in the bracket). The nodes shown in one line mean the train with this stop-schedule will stop at these stations. For example, T4 (3) means there are 3 trains take the same stop-schedule but with different departure times. And all of them will stop at stations A, B, C, D and E. According to the definition of TFN, the edge between node A and B is created by stop-schedule T4, T7 and T9, and the edge weight is the sum of frequencies of the three stop-schedules. Similarly, other edges and the weights in TFN are generated by the same way. With the constraints to RPN, the railway network physical topology and the operation strategies such as train running routes, origins and destinations, stop-schedules, and service frequencies can be transferred to the topological relations and weights of edges in TFN.

2.2. Key station identification index

Given the train flow network model, we can present the key station identification indices combining physical topological structure and train operation strategies. A set of function index in the view of TFN based on complex network theory will be proposed in this section, which shows the importance of different stations in the railway network.

a. Degree centrality (DC)

Degree centrality of a node v_i is the number of the connection between v_i and other nodes. It describes the physical connective influence of a node by the number of its neighbours. For the TFN, the degree centrality k_i of a node v_i is defined as Eq. 1.

$$k_i = \sum_{j=1}^N n_{i,j} \quad (1)$$

Where N is the number of the nodes in the network; $n_{i,j}$ is a variable of 0 and 1. If there is a connection between nodes v_i and v_j , $n_{i,j}=1$; otherwise, $n_{i,j}=0$. A node with a larger degree is likely to connect to more edges than a node with a smaller degree, which means a higher influence of connectivity in the whole network. In the TFN, the degree k_i of a node v_i is the number of stations that can be reached without a transfer from the station represented by v_i . The degree of a node in the TFN describes the topological reachability of the station.

b. Strength centrality (SC)

A very important feature of TFN is that each edge is not equally important. Some edges are more important than others, therefore, carry a higher weight, which depends on the service frequencies of different trains and therefore plays a greater role in contributing to the functioning of the whole network. Strength centrality can describe the weight of an edge. Strength centrality of a node v_i is the sum of the weights of the edges between v_i and other nodes. For the TFN, the strength centrality s_i of a node v_i is defined as Eq. 2.

$$s_i = \sum_{j=1}^N w_{i,j} \quad (2)$$

Where $w_{i,j}$ is the weight of the edge between node v_i and v_j . In the TFN, the weight $w_{i,j}$ of an edge between node v_i and v_j is the number of trains that stop at stations i and j . The strength of a node describes the service capability of the specific station, which represents the convenience of the passenger from this station to other stations that can be reached without a transfer.

c. Betweenness centrality (BC)

Betweenness centrality describes the influence of a node over the information spread through the network, which is based on shortest paths. For every pair of nodes in a network, there is at least one shortest path either the minimum number of edges that the path passes through or the minimum sum of the weights of the edges. In the TFN, the betweenness centrality (b_i) of a node v_i without the weights of edges is defined as topological betweenness centrality (TBC) and b_i can be represented by Eq. 3. Similarly, the betweenness centrality (b_i^w) of a node v_i with the weights is defined as capacity betweenness centrality (CBC) and b_i^w is represented by Eq. 4.

$$b_i = \frac{\sum_{j \neq k} g_{j,k}(i)}{\sum_{j \neq k} g_{j,k}} \quad (3)$$

$$b_i^w = \frac{\sum_{j \neq k} g_{j,k}^w(i)}{\sum_{j \neq k} g_{j,k}^w} \quad (4)$$

Where $g_{j,k}$ is the number of shortest paths with the minimal number of the edges from a node v_j to a node v_k ; $g_{j,k}(i)$ is the number of shortest paths with the minimal number of the edges, which pass through the node v_i from a node v_j to a node v_k . Likewise, $g_{j,k}^w$ is the number of shortest paths with the minimal sum of the weights of the edges from a node v_j to a node v_k ; $g_{j,k}^w(i)$ is the number of shortest paths with the minimal sum of the weights of the edges, which pass through the node v_i from a node v_j to a node v_k . The betweenness centrality reflects the influence of the nodes throughout the network. Influential nodes are those that are visited by the largest number of shortest paths from all nodes to the rest. Therefore, we can get the influential nodes in different perspectives of topological connectivity and transportation capacity.

d. Clustering coefficient (CC)

The clustering coefficient is a key quantity that characterizes the extent to which the nodes in the neighbourhood of a certain node are connected. The higher the value of a clustering coefficient of a node, the more densely connected the nodes in its neighbourhood will be. The clustering coefficient c_i of a node v_i is defined as Eq. 5.

$$c_i = \frac{2m_i}{k_i(k_i+1)} \quad (5)$$

Where the k_i nodes are the neighbours of the node v_i , and k_i is also the degree centrality of v_i . Thus, there are at most $k_i(k_i - 1)/2$ arcs between the k_i nodes. The m_i is the real number of the arcs between the k_i nodes. A node with a higher clustering coefficient means the node and its neighbours tend to be a close organization. In the TFN, the higher clustering coefficient means an intensive requirement between the stations for the transportation of passengers and goods. It shows the influence of the station in the local area of the network.

e. Comprehensive index (CI)

The key station set and the rank of the stations identified by the five indices may be different, due to the influence of the stations evaluated by these indexes is in different points of view. To balance these different, a comprehensive index C_i should be given based on the five basic

indexes. First, the basic indexes can be normalized by Eq. 6. Then, the comprehensive index C_i of a node v_i can be the sum of these normalized indices, formulated as Eq. 7.

$$\bar{z}_i^\alpha = \frac{z_i^\alpha - z_\alpha^{\min}}{z_\alpha^{\max} - z_\alpha^{\min}}, \quad \alpha=1,2,L,5 \quad (6)$$

$$C_i = \sum \lambda_\alpha \bar{z}_i^\alpha, \quad \alpha=1,2,L,5 \quad (7)$$

Where z_i^α represents the value of any of the basic indexes of a node v_i ; z_α^{\min} is the minimum value of the basic index α of the stations in TFN; z_α^{\max} is the maximum value of the basic index α of the stations in TFN; \bar{z}_i^α is normalized value of the basic index α of the station v_i ; λ_α is the weight of the basic index α , which shows the impact of different basic indexes in the comprehensive index. The principle for selection of λ_α is reflecting the evaluation purpose such as the topological connectivity, transportation capacity and local influence. Some methods, such as the trial and error method and the Delphi method can be used in the selection of λ_α .

2.3. Network efficiency analysis

Network reliability can be obtained by the analysis of the characteristics of the network under random and selective modes of stations failure (Lin et al. 2016). The difference between the two modes is to decide the failure order of the stations. In the first mode, the failure stations are randomly selected, however, the node and its edges are removed to form a new network. In the second mode, the failure order should be consistent with the ranks of the stations which can be obtained by CI. The two indexes of network efficiency (E) and relative network efficiency (R) are given to evaluate the reliability of the TFN, which are derived from Eq. 8 and Eq. 9.

$$E = \frac{2}{n(n-1)} \sum_{i \geq j}^n d_{i,j} \quad (8)$$

$$R = \frac{E}{E_0} \quad (9)$$

Where n is the number of nodes in the network after the failure of the stations and edges, $d_{i,j}$ represents the shortest network distance between node v_i and v_j but when they are not connected $d_{i,j} = +\infty$, E is the network efficiency after the failure and E_0 is the initial network efficiency.

3. CASE STUDY

In this section, a case study of reliability analysis of railway network in China is presented. Firstly, the TFN is established based on the model given in section 2 from the train timetable of June 2015 as described in below sections. Secondly, the key station identification indices are calculated based on TFN, and the comprehensive index can be generated from basic indices as discussed in section 2.2. Finally, the network efficiency analysis under different failure modes is discussed in detail.

3.1 High-speed railway network in China

China has world's longest high-speed railway network, which has rapidly been developed in the recent years. By the end of 2015, the operation mileage was over 19,000km (National railway administration of China, 2016), which is more than 50% of the world's total mileage. There are 3 kinds of High-speed trains in China, high-speed trains (with the subtitle of G), intercity trains (with the subtitle of C) and trains running on the existing line after upgraded (with the subtitle of D). The average operation speeds of these trains are 300km/h, 250km/h and 200km/h respectively. According to the train timetable on June 10, 2015, there are 2487 trains running on the high-speed railway network including 1062 G, 466 C and 959 D trains. In order to ensure the connectivity of the railway network, 2 isolated lines Haikou to Sanya and Urumqi north to Lanzhou West high-speed rail line are removed from the network for the case study. As a result, the RPN has 485 nodes and 570 edges as shown in Fig.4. Whereas, the TFN has the same number of nodes, however, due to the addition of service plan, the number of edges has reached to 68198 making it more complex than RPN.

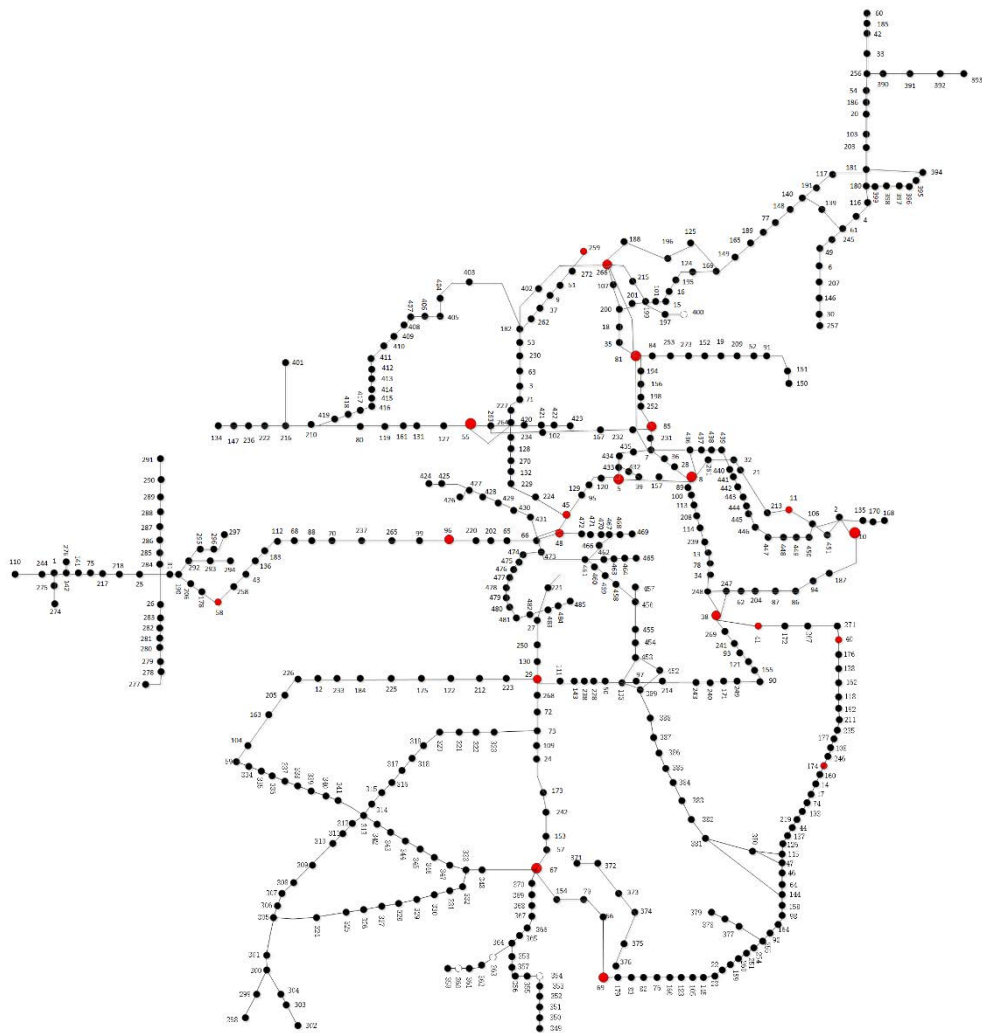

Figure 4 High-speed railway physical network in China

3.2 Key station identification

a. Degree centrality

The distribution and cumulative distribution of DC can be calculated by Eq. 1, which is shown in Fig. 5 and Fig. 6. In the TFN, the number of the stations with DC of more than 150 is only 2% of the whole network. And most of them are the hub stations converged by several rail lines, such as *Shanghai Hongqiao* station, *Nanjing South* station, *Wuhan* station, *Hangzhou East* station etc. It can be observed that the cumulative distribution of DC is exponential, which can be formulated as follows:

$$p(>k) = 1.09e^{-0.02} \quad (10)$$

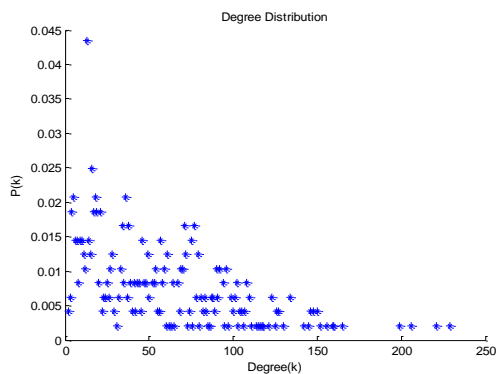

Figure 5 Distribution of DC

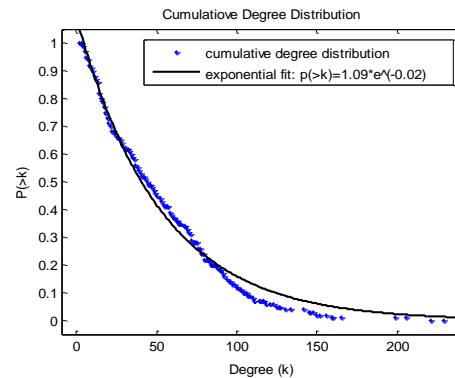

Figure 6 Cumulative distribution of DC

b. Strength centrality

The cumulative distribution of SC is shown in Fig.7. The statistics show that the SC of 4.59% stations is greater than 1000, and for 60.04% it is less than 200, indicating that the distribution of SC of the stations in the TFN is extremely deviated. There are a few stations having very high service capacity. It is more convenient for the passengers to travel from these stations than others. It can be observed that the distribution of DC versus SC follows a power law (shown as Fig. 8), which can be formulated as follows:

$$s \propto k^{1.242} \quad (11)$$

It means the growth rate of SC is faster than the DC, which shows that in the current transportation operation strategy if the topological connectivity of a station is k the ability to serve the passengers is $k^{1.242}$, therefore, the transportation capacity of a station is growing faster than the growth of topological connectivity.

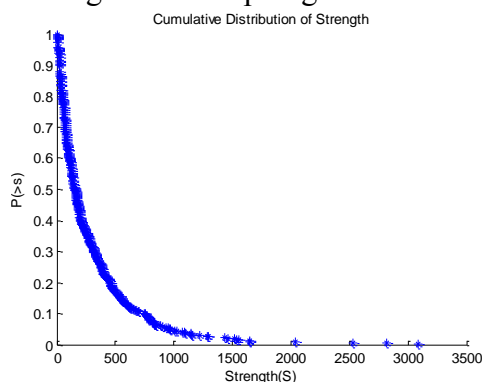

Figure 7 Cumulative distribution of SC

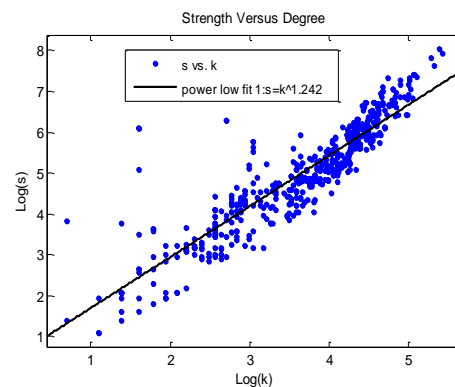

Figure.8 Distribution of DC versus SC

c. Betweenness centrality

The distribution of TBC and CBC in the TFN is shown in Table 1. Most of the stations have a very small TBC and CBC, but very few stations' BC are very large, which is 1.8% stations with the interval of 0.05730~0.06548. So these stations have very important significance in the TFN.

Table 1: The distribution of TBC and TFN

No	Interval	Probability of TBC	Probability of CBC
1	0~0.00005	0.168498	0.161172
2	0.00005~0.00030	0.131868	0.14652
3	0.00030~0.00100	0.194139	0.201465
4	0.00100~0.00307	0.197802	0.201465
5	0.00307~0.00501	0.124542	0.10989
6	0.00501~0.00603	0.03663	0.032967
7	0.00603~0.01037	0.058608	0.058608
8	0.01037~0.02206	0.040293	0.040293
9	0.02206~0.05730	0.029304	0.029304
10	0.05730~0.06548	0.018315	0.018315

d. Clustering coefficient

The average CC of the TFN is 0.697, showing high aggregation characteristics as shown in Fig. 9. While, the relationship between the CC and DC of each node is shown in Fig. 10. From the relationship graphs, it is clear that the nodes with high CC have very low DC and DC and CC show a negative correlation, which means the lower the DC of the station, the greater the CC.

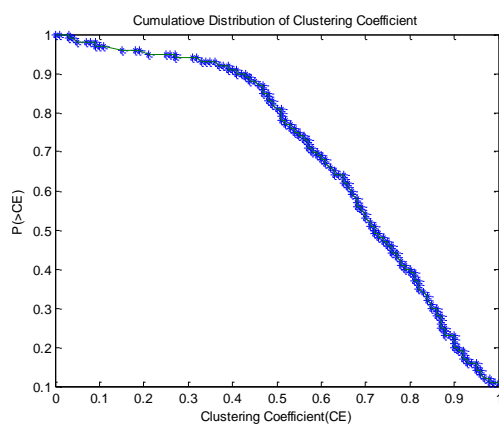

Figure 9 Cumulative distribution of CC

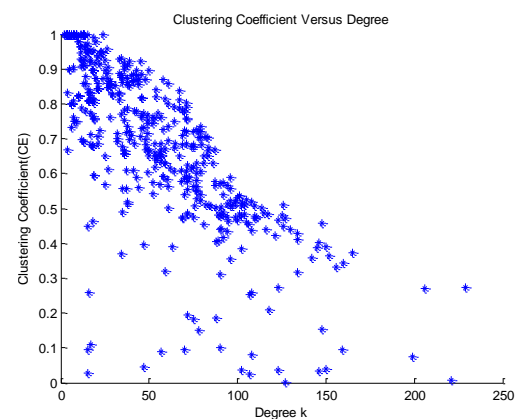

Figure 10 Distribution of CC versus DC

e. Comprehensive index

The distributions of the basic indices for the stations are different, therefore, the rank of key stations cannot be the same. Table 2 shows the top 20 stations in different indices. Whereas, the nodes with top 20 high CI are indicated with red colour in Fig. 4. Most of the high CI nodes distribute in the central and eastern regions of China, because higher economic development has higher population density and brings more transportation needs. However, not all the top 20 stations are junctions such as No.11, 40, 41, 58, 96 and 174. These nodes have higher transportation capacity, though lower physical connectivity. Thus, these stations should be given more maintenance and be more likely to be included when a new railway line is planned in the future. The stations of No. 259 and 266 in Beijing city, the capital of China, are ranked as 17 and 14, which is not the higher level in the TFN. Since there are 4 stations in Beijing to decentralize transport pressure. However, there are only 2 stations (266 and 259) in top 20 and the sum of their CI is 3.10, higher than 2.91 of the first station No. 8. Increasing some hub lines between the 4 stations can improve capacity and reliability of transportation of the whole city, which should be one direction in the future design of the railway infrastructure.

Table 2: Comparison of top 20 stations in different indexes

Rank	Station (DC)	Station (SC)	Station (TBC)	Station (CBC)	Station (CC)	Station (CI)	CI
1	8	8	5	29	215	8	2.909347
2	10	10	69	48	217	10	2.856245
3	38	38	55	10	219	5	2.594738
4	48	29	45	8	187	69	2.51187
5	85	40	96	256	246	48	2.282593
6	5	81	266	69	234	29	2.281926
7	29	85	259	58	89	38	2.179361
8	40	48	19	67	90	45	1.962085
9	11	174	22	38	258	55	1.914219
10	41	25	61	11	259	96	1.842426
11	81	5	232	85	260	85	1.718422
12	2	11	30	81	88	11	1.69267
13	43	12	24	5	250	40	1.651933
14	13	248	7	2	257	266	1.626548
15	12	67	4	25	261	58	1.615441
16	39	2	58	18	272	81	1.60119
17	83	13	254	13	235	259	1.473424
18	67	41	46	40	266	67	1.467032
19	160	126	208	27	267	41	1.460257
20	69	44	56	41	209	174	1.423473

3.3. Network efficiency analysis

The efficiency of TFN is 2.10, much higher than 0.06 of RPN, which means the physical connectivity of the high-speed railway network in China is not very dense, but it has a very high service capacity and convenient transportation services. Distributions of R under different failure modes are shown in Fig.11. The relative network efficiency is declined sharply in the beginning of the selective mode, however, is relatively flat in the random mode. The failure of the top 20 stations, 4% of the total nodes shows a higher loss of efficiency in the both modes, which are close to 70% and 40% respectively. Furthermore, the top 40% failure makes the

network efficiency loss to nearly 0 in selective mode, while in random mode, 80% failure dropped the efficiency to almost 0. Therefore, the key stations that are identified in section 2.2 should be given more attention in the future development of the railway network.

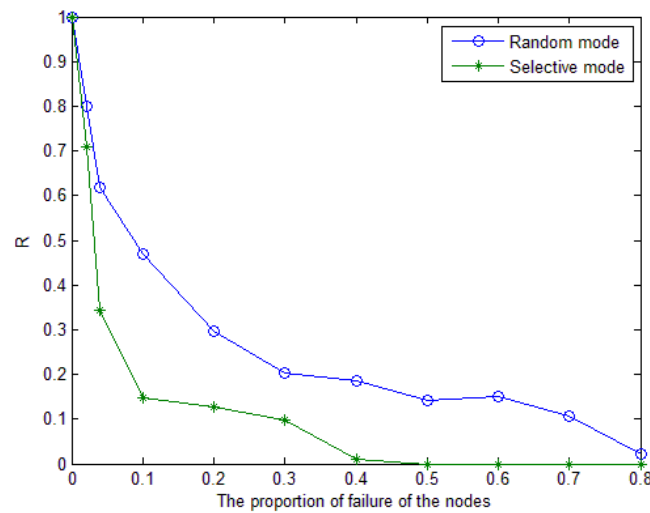

Figure 11 Distribution of R under different failure modes

4. RECOMMENDATIONS TO IMPROVE RAILWAY NETWORK

Based on the reliability analysis of the railway network, the optimised suggestions of improving the network considering in the following two terms.

a. Railway network infrastructure planning

- The reliability of the network should be considered in the future infrastructure planning, in addition to the economic and demographic factors. Some high-CI stations have only one railway line passing through should be included when a new rail line is planned, which will not only balance the distribution of the key stations in the network and relieves the transportation pressure but also help to improve the network reliability.
- The combination of the topology of RPN indicates that some stations are located in the same city, for instance, 4 in Beijing and 3 in Shanghai. Some hub links between these stations should be allocated in the future, which will not only be able to improve the physical connectivity and transportation service of stations but also improve the reliability of the whole network in different failure modes.

b. Railway transportation operation

According to the reliability analysis of the railway network, once the key stations are failed or lost capacity, the connectivity and efficiency of the overall network would drop rapidly. To ensure the normal operation of the railway, it is recommended to strengthen the protection of the key stations, for example, protection strategies in advance to reduce the impact of disaster weather, organizing extra trains to improve transportation capacity etc. Furthermore, service capacity can be improved by optimising operation scheme with the constraints of the existing RPN. Therefore, higher k power means higher service capacity as shown in Eq. 11, which means a better operation scheme. Nevertheless, all these principles should be considered in the future to improve the stability of the high-speed railway Network.

5. CONCLUSIONS

The paper presented a new method to analyse the reliability of the railway network by identification of the key stations based on the two network models of RPN and TFN. In addition, both physical network topology and dynamic operation strategies are considered in this method. Considering the key stations, railway network efficiency is analysed under selective and random failure modes. A real-world case study of the high-speed railway network in China is presented to demonstrate that the cumulative distribution of DC is exponential and the relationship between DC and SC follows power distribution. Furthermore, the key stations were obtained by the CI by considering all the factors of topological connectivity, transportation capacity and local influence. Therefore, maintenance of these key stations can ensure a higher reliability of the whole network. In the end, some recommendations are given in terms of infrastructure planning and transportation operation of the railway network in order to improve the network development.

6. ACKNOWLEDGMENTS

This study is funded by the National Key Research and Development Programme of China (2016YFB1200401), National Natural Science Foundation of China (61374157 & 71501190), and Beijing Jiaotong University State Key Laboratory of Rail Traffic and Control and Safety (RCS2017K001 & RCS2016ZT016). The support of the China Scholarship Council is also gratefully acknowledged.

7. REFERENCES

- UIC. (2015). *High speed rail brochure- 2015*. <http://www.uic.org/highspeed>.
- Zenil, H., Kiani, N. A., and Tegnér, J. (2014). *Methods of information theory and algorithmic complexity for network biology*. arXiv preprint arXiv:1401.3604.
- Vázquez, A., Pastor-Satorras, R., and Vespignani, A. (2002). *Large-scale topological and dynamical properties of the Internet*. Physical Review E: Statistical, Nonlinear, and Soft Matter Physics, 65(6), 066130.
- Yin, L. C., Kretschmer, H., Hanneman, R. A., and Liu, Z. Y. (2006). *Connection and stratification in research collaboration: An analysis of the COLLNET network*. Information Processing & Management, 42(6), 1599-1613.
- Koseoglu, M. A. (2016). *Mapping the institutional collaboration network of strategic management research: 1980–2014*. Scientometrics, 109(1), 203-226.
- Chassin, D. P., and Posse, C. (2005). *Evaluating North American electric grid reliability using the Barabási–Albert network model*. Physica A: Statistical Mechanics and its Applications, 355(2), 667-677.
- An, X. L., Zhang, L., Li, Y. Z., and Zhang, J. G. (2014). *Synchronization analysis of complex networks with multi-weights and its application in public traffic network*. Physica A: Statistical Mechanics and its Applications, 412, 149-156.
- Meng, X., Xiang, W., and Wang, L. (2015). *Controllability of train service network*. Mathematical Problems in Engineering, 2015.
- Xu, X., Hu, J., Liu, F., and Liu, L. (2007). *Scaling and correlations in three bus-transport networks of China*. Physica A: Statistical Mechanics and its Applications, 374(1), 441-448.
- Sen, P., Dasgupta, S., Chatterjee, A., Sreeram, P. A., Mukherjee, G., and Manna, S. S. (2003). *Small-world properties of the Indian railway network*. Physical Review E: Statistical, Nonlinear, and Soft Matter Physics, 67(3), 036106.
- Porta, S., Crucitti, P., and Latora, V. (2006). *The network analysis of urban streets: a dual approach*. Physica A: Statistical Mechanics and its Applications, 369(2), 853-866.
- Wang, S., Zheng, L., and Yu, D. (2017). *The improved degree of urban road traffic network: A case study of Xiamen, China*. Physica A: Statistical Mechanics and its Applications, 469, 256-264.
- Bagler, G. (2008). *Analysis of the airport network of India as a complex weighted network*. Physica A: Statistical Mechanics and its Applications, 387(12), 2972-2980.

- Dall'Asta, L., Barrat, A., Barthélemy, M., and Vespignani, A. (2006). *Vulnerability of weighted networks*. Journal of Statistical Mechanics: Theory and Experiment, 2006(04), P04006.
- Zio, E., and Sansavini, G. (2011). *Modeling interdependent network systems for identifying cascade-safe operating margins*. IEEE Transactions on Reliability, 60(1), 94-101.
- Dey, P., Mehra, R., Kazi, F., Wagh, S., and Singh, N. M. (2016). *Impact of Topology on the Propagation of Cascading Failure in Power Grid*. IEEE Transactions on Smart Grid, 7(4), 1970-1978.
- Buldyrev, S. V., Parshani, R., Paul, G., Stanley, H. E., & Havlin, S. (2010). *Catastrophic cascade of failures in interdependent networks*. Nature, 464(7291), 1025-1028.
- Ren, H. P., Song, J., Yang, R., Baptista, M. S., and Grebogi, C. (2016). *Cascade failure analysis of power grid using new load distribution law and node removal rule*. Physica A: Statistical Mechanics and its Applications, 442, 239-251.
- Yan, J., He, H., and Sun, Y. (2014). *Integrated security analysis on cascading failure in complex networks*. IEEE Transactions on Information Forensics and Security, 9(3), 451-463.
- Dunn, S., and Wilkinson, S. (2017). *Hazard tolerance of spatially distributed complex networks*. Reliability Engineering and System Safety, 157, 1-12.
- Guidotti, R., Gardoni, P., and Chen, Y. (2017). *Network reliability analysis with link and nodal weights and auxiliary nodes*. Structural Safety, 65, 12-26.
- Qian, Y., Wang, B., Xue, Y., Zeng, J., and Wang, N. (2015). *A simulation of the cascading failure of a complex network model by considering the characteristics of road traffic conditions*. Nonlinear Dynamics, 80(1-2), 413-420.
- Chen, S., Zou, X., Xu, Q., and Lv, H. (2014). *Invulnerability optimization of Chinese railway traffic network for suppressing cascading failure*. Journal of Information and Computational Science, 11(5), 1501-1509.
- Lin, S., Jia, L., Wang, Y., Qin, Y., and Li, M. (2016). *Reliability Study of Bogie System of High-Speed Train Based on Complex Networks Theory*. In Proceedings of the 2015 International Conference on Electrical and Information Technologies for Rail Transportation (pp. 117-124). Springer Berlin Heidelberg.
- Li, L., Jia, L., Wang, Y., and Li, J. (2015). *Reliability evaluation for complex system based on connectivity reliability of network model*. In Logistics, Informatics and Service Sciences (LISS), 2015 International Conference on (pp. 1-5). IEEE.
- Ouyang, M., Zhao, L., Hong, L., & Pan, Z. (2014). *Comparisons of complex network based models and real train flow model to analyze Chinese railway vulnerability*. Reliability Engineering and System Safety, 123, 38-46.
- National railway administration of China. (2016). *National railway statistical bulletin of 2015*. http://www.nra.gov.cn/xwzx/zlzx/hytj/201603/t20160303_21466.shtml.

CONSIDERATIONS OF OUT-OF-GAUGE FREIGHT TRANSPORTATION IN RAILWAY INFRASTRUCTURE DEVELOPMENT AND MAINTENANCE PROJECTS

Y. Zhang^{1,*}, M. An^{2,*}, L. Wang³ and D. Lei¹

¹ School of Traffic and Transportation Engineering, Central South University, Changsha, 410075, China

² School of the Built Environment, University of Salford, Manchester, M5 4WT, UK

³ School of Traffic and Transportation, Beijing Jiaotong University, Beijing, 100044, China

Email: ygzhang@csu.edu.cn; M.An@Salford.ac.uk

Abstract: The demands of railway infrastructure development are increased to meet rail transport requirements, particularly, for those large scale equipment and oversized cargoes that are often beyond railway gauges such as vehicle/infrastructure structure gauges. Railway administrators have to check clearances between out-of-gauge trains carrying with these railway out-of-gauge freights (ROFs) and all of railway infrastructures along their routes, i.e., bridges, tunnels, platforms, signal equipment and over-head power lines to ensure its safety. Therefore, the safety of ROF transportation requirements should be taken into consideration in railway infrastructure development and maintenance projects. This paper presents methods for modelling of ROF loading outline and the minimum infrastructure structure gauges. A railway gauges double-checking algorithm has also been developed to calculate gap distances between vehicles and infrastructures which can provide useful information for railway designers, engineers and managers in the design, construction and maintenance of railway infrastructures. A case example of ROF transport routing problem is used to demonstrate the clearance safety requirements. The results show that gap distances between vehicles and infrastructures are major factors that can impact on ROF transportation safety, which should be integrated into the design, construction and maintenance projects of railway infrastructures.

Keywords: Clearance Safety Requirements, Loading Outline, Out-Of-Gauge Freight Transportation, Railway Gauges, Railway Infrastructure

1. INTRODUCTION

Generally, trains and railway infrastructure structures are built to vehicle gauges and structure gauges, respectively, and there are safe clearances or gaps requirements between trains and infrastructure. As the safest and lower cost form of ground transportation, more and more cargoes, including lots of large scale equipment and oversized cargoes, are being attracted by railway transport. Railway out-of-gauge freights (ROFs) refer to these oversize cargoes which are much wider, longer or higher than other kinds of railway freights, and ROF loading outline is often beyond railway gauges such as vehicle gauges and railway infrastructure structure gauges (Zhang et al. 2016), and railway out-of-gauge trains carrying with ROFs are underlying factors for railway accidents. Railway companies have to locate unsafe railway infrastructure precisely and further carry out some necessary maintenance projects for these infrastructures with small clearances and high risks for ROF safety transportation. Moreover, the railway now finds itself in a situation where safety is a real and urgent issue, to be dealt with in a public culture of rapid change, short-term pressures and instant communications (An, 2006), and risk management is becoming increasingly important for railway companies (An, 2011; An, 2016). As an important component of railway risk management, railway administrators have to check and judge clearances safety requirements between out-of-gauge trains and all of railway infrastructures along their routes, i.e., bridges, tunnels, platforms, signal equipment, over-head power lines to ensure its safety. However, there are so many small railway infrastructures

gauges that lots of ROFs may be transported unsafely. Railway companies should reconstruct old infrastructures with small clearances or build new infrastructures with big clearances for railway transportation safety with high efficiency.

There was a time when trains were built to vehicle gauges, structures were built to structure gauges, and there was a large gap between the two (Johnson, 2008). It was immediately clear that gauge sensitive freight traffic did not, and would be unlikely to, operate on large sections of the network; it would be possible to determine a hierarchy of routes to be considered for enhancement. Wilson (2008) outlined the historical development and issues which affect railway vehicle gauge on the Great Britain rail network. Since ROFs loading outlines are often bigger than general railway freight, ROF safety transport is much more sensitive to the heritage structure gauges in the rail network. Thus, costly temporary maintenance tasks are often needed to solve ROF transport routing problem (namely ROF-TRP). The safety of ROF transportation requirements should be taken into consideration in the railway infrastructure development and maintenance projects in order to reduce such costly work. Also, if railway infrastructure gauges can meet clearance safety requirements for out-of-gauge trains running in the rail network, there must be larger safe gaps between other trains and infrastructures.

ROF safety transport is affected by gap distances between rail vehicles and infrastructures greatly. Few literatures were dedicated to analyse gap distances and check clearances between ROF loading outline and railway gauges. In practice, out-of-train dispatchers often check them simply by comparing ROF's widths and railway gauges at the same height, which has potential risks, i.e., neglecting controllable infrastructures. Thus, a safety gap distance calculation and gauges checking method is crucial for railway safety transport. Although Tang et al. (2012) has designed an optimal model for ROF transportation route, they did not refer to the gap distance calculation and gauges checking problem. If detail information about gap distance between ROF loading outline and railway gauges cannot be gained, it will lead to severe rail safety issues, i.e., train collisions with these infrastructures along routes due to unsafe clearances, and train derailment. Wang (2012) has studied railway out-of-gauge trains transport organization problems, and Zhang et al. (2016) have discussed non-crossing block sections setting rules for railway out-of-gauge train running on double-track railway line. In order to make maximum use of the restrictive and sensitive railway gauges, a new method to check gap distances and clearances precisely between ROF loading outline and railway gauges will be proposed and the needs of rail infrastructure development and maintenance projects on basis of ROF safety transportation will be studied at the first time in the paper.

The remainder of this paper is organized as follows. Section 2 analyses ROF loading outline and railway infrastructure structure gauges and their gap distances. A railway gauges double-checking algorithm is developed to calculate gap distances between ROF loading outline and infrastructure structure gauges in order to judge clearance safety requirements in Section 3. Then, a ROF transport routing model based on safe clearances is designed and its solution method is also put forward in Section 4. In section 5, discussions about railway infrastructure development and maintenance projects based on a case of ROF-TRP are given. The paper is finished in Section 6 with some conclusions and discussions for our future research.

2. ROF LOADING OUTLINE AND INFRASTRUCTURE STRUCTURE GAUGES

Since ROF loading outline may beyond railway gauges and the freight train is general heavy, their maximum loaded weight, length and speed for freight trains, i.e. out-of-gauge trains, must

be restricted (Lei & Rose, 2008). For oversize cargoes, their transport routes should be selected on basis of railway gauges and clearances for safety. Meanwhile, large gap distances construction criteria should be taken into consideration in railway infrastructure development and maintenance projects to guarantee railway transport safety and reduce potential risks.

It's the first thing for a safety route that there are enough clearances or gaps between railway loading outline and infrastructure structure gauges. Also, there are many factors for shaping ROF loading outline, such as original outline (maximum height and width), loading vehicle's characteristics (i.e. vehicle type and number, possible highest or lowest vehicle floor's height, bogie center distance). In general, typical ROF loading outlines are shown in Figure 1.

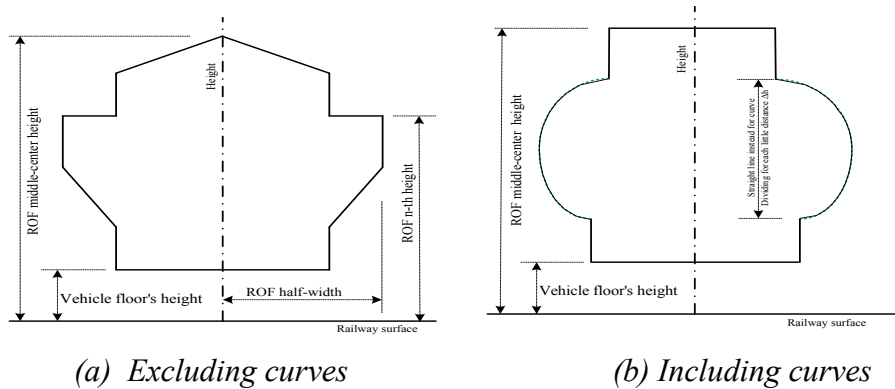

Figure 1: ROF loading outlines

In Figure 1, the horizontal axis is the railway surface and the vertical axis is the longitudinal center line of ROF loading vehicle and railway tracks; the highest loading height is named as middle-center height, and the lowest height is equal to its loading vehicle floor's height. For other heights from top to bottom, they are called 1st-side height, 2nd-side height, ..., nth-side height respectively. If there is a curve in a ROF loading outline (please see Figure 1(b)), it can be divided into straight lines for each small height Δh . ROF loading vehicles may be remarshaled many times at marshalling stations, and it's difficult to control ROF running directions (Wang, 2012). Also, in order to make maximum use of restrictive loading gauges, a systematic method for validation is essential for obtaining dependable results (Perez et al, 2008). Out-of-gauge dispatchers often consider that loading outline is exactly symmetrical to guarantee safety. Thus, a ROF loading outline can be recorded as shown in Table 1.

Table 1: ROF loading outline (unit: mm)

No.	Location	Higher height	Lower height	Half-width
0	Middle-center height	> Floor's height		> 0
1	1 st -side height	> Floor's height		> 0
		...		
n	n th -side height	> Floor's height	Floor's height	> 0

Thus, ROF loading outline can be further represented as

$$\mathbf{H} = \begin{pmatrix} h_{00} & h_{01} & w_0 \\ h_{10} & h_{11} & w_1 \\ \vdots & \vdots & \vdots \\ h_{n0} & h_{n1} & w_n \end{pmatrix} \cup \begin{pmatrix} h_{00} & h_{01} & -w_0 \\ h_{10} & h_{11} & -w_1 \\ \vdots & \vdots & \vdots \\ h_{n0} & h_{n1} & -w_n \end{pmatrix},$$

where h_{a0} ($h_{a0} > 0$), h_{a1} ($h_{a1} > 0$ or $h_{a1} = \text{NULL}$), w_a ($w_a > 0$) express the higher height, the lower height and the half-width at the a -th side height ($a \in \{0, 1, 2, \dots, n\}$). w_a and $-w_a$ indicate that half-width at the right and left of the longitudinal center line of railway tracks respectively. If $h_{a1} = \text{NULL}$ ($a < n$) or $h_{a1} = h_{a+1,0}$ ($h_{a1} > 0, w_a \neq w_{a+1}, a < n$), the two neighbour side-heights a and $a+1$ are connected by an oblique line (see oblique lines in Figure 1(a)). Also, $h_{00} > h_{10} > \dots > h_{n0} > 0$, $h_{a0} > h_{a1}$ ($h_{a1} > 0, \forall a$), $h_{a1} \geq h_{a+1,0}$ ($h_{a1} > 0, a < n$), $h_{n1} > 0$.

Another factor of the clearance is the railway structure gauge (Wilson, 2008; Johnson, 2008). There are bridges and tunnels gauges and other infrastructures (i.e. platforms, buildings, electrical equipment boxes, railway signal equipment and over-head contact line equipment) gauges in railway system (Wang, 2012; Zhang et al., 2016). For each railway intersection, there is a minimum comprehensive structure gauge which is determined by bridges and tunnels gauges, other infrastructures gauges in this intersection. It is not symmetrical in most conditions. When trains pass through these intersections, their loading outline must be within the minimum comprehensive structure gauges for safety, which can be expressed as

$$\mathbf{S} = \begin{pmatrix} h'_{10} & h'_{11} & w'_1 \\ h'_{20} & h'_{21} & w'_2 \\ \vdots & \vdots & \vdots \\ h'_{m0} & h'_{m1} & w'_m \end{pmatrix},$$

where h'_{b0} ($h'_{b0} > 0, b \in \{1, 2, \dots, m\}$), h'_{b1} ($h'_{b1} > 0$ or $h'_{b1} = \text{NULL}$), $|w'_b|$ ($w'_b \neq 0$) express higher heights, lower heights, distances from the longitudinal center line (all units are mm), and m indicates the total number controllable locations for the gauge. If the controllable location on the minimum comprehensive structure gauge lies at the right of the longitudinal center line, the value of w'_b is positive; otherwise, $w'_b < 0$. If the controllable part is isolated from other equipment, $h'_{b1} = \text{NULL}$. Let \mathbf{S}_{ij} denote the minimum comprehensive structure gauge at the intersection e_{ij} between two railway adjacent stations p_i and p_j in a given rail network \mathbf{G} .

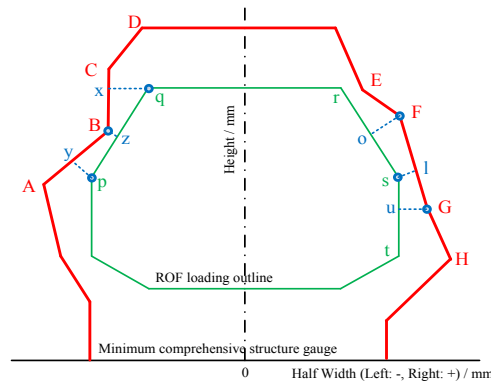

Figure 2: Gap distances between loading outline and railway gauges

In Figure 2, the outer red lines indicate the minimum comprehensive structure gauge and the inner green lines mean ROF loading outline. All gap distances at controllable parts (such as points A-H and p-t in Figure 2) of the minimum comprehensive structure gauge and ROF loading outline should be calculated. Then, the minimum one $dis(\mathbf{H}, \mathbf{S}_{ij})$ can be expressed as $dis(\mathbf{H}, \mathbf{S}_{ij}) = \min \{|py|, |qx|, |sl|, |Bz|, |Fo|, |Gu|, \dots\}$. ROF loading outline consists of straight lines while structure gauges are composed of straight lines and isolated points (Wang, 2012). Thus, there are two cases for each ROF gap distance, which can be further determined by the following methods (the controllable parts r' and s' are at the ROF loading outline and the controllable part F' is at the minimum comprehensive structure gauge in Figure 3; y' is the pedal point): (i) Gap distance between the point F' and the straight line $r's'$ is $|F'y'|$ (Figure 3(a)); (ii) Gap distance between them is $\min \{|F's'|, |F'r'|\}$ (Figure 3(b)).



Figure 3: ROF gap distance calculation methods

3. RAILWAY GAUGES DOUBLE-CHECK ALGORITHM

The correct calculation and checking method of gap distance between ROF loading outline and railway gauges is crucial for ROF safety transport, but it's ignored by Tang et al (2012). As shown in Figure 2, if gap distances are calculated based on controllable parts at the ROF loading outline (the former method), the minimum gap distance is $|sl|$ and the controllable location is at the right of the loading outline. However, the actual smallest clearance is at the left of the longitudinal center line ($|Bz| < |sl|$) and the real controllable location is at the left of the loading outline. Similarly, it's unsafe to calculate gap distance only based on controllable points at railway gauges (the latter method). There is an example (see Figure 4(a)) to demonstrate the latter one has also potential transport risks. If gap distances are calculated based on controllable parts (blue ones) at railway gauges, the train carrying with such ROFs can run at the intersection safely. However, ROF loading outline is beyond railway gauges in the intersection, i.e., the controllable parts (red cross ones) as shown in Figure 4(a).

From Figure 2 and Figure 4 (a), neither the former nor the latter method is secure and both methods have potential risks. Thus, gap distances should be calculated by all controllable parts both at ROF loading outline and railway gauges (namely double-checking), and the minimum gap distance between them and controllable infrastructure parts or locations will be determined. Railway gauges double-checking algorithm (RGDCA) can be described as,

Input: ROF loading outline \mathbf{H} , railway structure gauge \mathbf{S}_{ij} safety allowance δ .

Output: Minimum gap distance d_{gap} (mm), controllable infrastructure parts \mathbf{L}_{gap} .

- Step 1:** Assume temporary gap distance sets $\mathbf{g}_H = \emptyset$, $\mathbf{g}_S = \emptyset$, $\mathbf{g}_{ROF} = \emptyset$, and controllable infrastructure parts and its locations $\mathbf{g}_{cpl} = \emptyset$, $d_{temp} = 0$, $d_{gap} = 0$.
- Step 2:** Calculate gap distances d_{temp} based on controllable parts at ROF loading outline \mathbf{H} ; if $d_{temp} \leq d_{fix}$, then $\mathbf{g}_H = \mathbf{g}_H \cup \{d_{temp} - \delta\}$ and store its information into the set \mathbf{g}_{cpl} .
- Step 3:** Calculate gap distances d_{temp} based on controllable parts at railway gauges \mathbf{S}_{ij} , if $d_{temp} \leq d_{fix}$, then $\mathbf{g}_S = \mathbf{g}_S \cup \{d_{temp} - \delta\}$ and store its information into the set \mathbf{g}_{cpl} .
- Step 4:** $\mathbf{g}_{ROF} = \mathbf{g}_H \cup \mathbf{g}_S$, $d_{gap} = \min\{\mathbf{g}_{ROF}\}$, $\mathbf{L}_{gap} = \{l_{gap} \mid l_{gap} \in \mathbf{g}_{cpl}, d_{temp} = d_{gap}\}$.

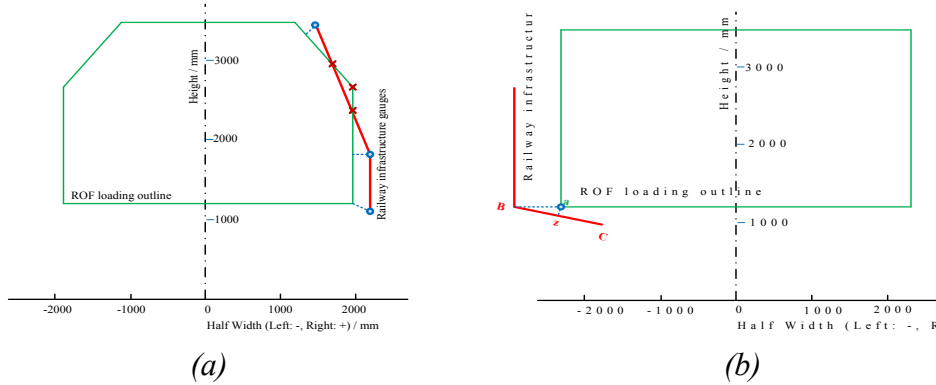

Figure 4: Comparison between different gap distance calculation methods

In the algorithm RGDCA, a constant d_{fix} is to exclude big clearances to reduce the size of gap distance sets. Temporary gap distance d_{temp} may be calculated by another simple method that is to compare half-width of the ROF and the distance (from controllable parts at structure gauges to the longitudinal center line) at the same height. Although such method may be easy to understand and safe in many situations (as shown in Figure 4 (a)), it has potential risks and leads to unpredictable train accidents. In Figure 4 (b), point “a” is a controllable part at ROF loading outline, while point “B”, “C” is controllable parts at railway gauges. Point “a” and “B” are at the same height. Point “z” is the pedal point at straight line “BC” from the point “a”. With such simpler method, the gap $|aB|$ is so large that there is enough clearance and such ROF may pass through the intersection safely. However, the actual minimum distance is $|az|$ and it cannot pass it through safely. Therefore, the proposed double-checking algorithm based on the proposed gap distance calculation method should not be ignored or replaced for safety.

4. ROF TRANSPORT ROUTING MODEL BASED ON SAFE CLEARANCE

The key of ROF-TRP is to find the most economic route for ROF transport from its origin station to destination station in the railway network with the constraints of flow balance at each railway station and safe clearance requirement between ROF loading outline and railway infrastructure structure gauges along its path to guarantee ROF transport safety.

Let $\mathbf{G} = (\mathbf{V}, \mathbf{E})$ express the rail network, in which \mathbf{V} expresses the railway stations set and \mathbf{E} is the railway intersections set. There is only ROF flow-out at the origin station $o(o \in \mathbf{V})$, only

ROF flow-in at the destination station $d (d \in \mathbf{V})$, and there is equivalent flow-in and flow-out at other stations along the transport route. Let $\varphi(i) = \{j \in \mathbf{V} | e_{ij} \in \mathbf{E}\}$ demonstrate the out-adjacent stations set of the station p_i , and $\beta(i) = \{j \in \mathbf{V} | e_{ji} \in \mathbf{E}\}$ indicate its in-adjacent stations set. Thus, the flow balance constraint in the rail network \mathbf{G} can be expressed by,

$$\sum_{i \in \varphi(i)} x_{ij} - \sum_{j \in \beta(i)} x_{ij} = \begin{cases} 1 & i = o \\ 0 & i \neq o, d \\ -1 & i = d \end{cases} \quad (1),$$

where x_{ij} is the decision parameter of ROF-TRP and its value is 0 or 1. If the railway intersection e_{ij} is selected as one part of the ROF transport route, $x_{ij} = 1$; otherwise, $x_{ij} = 0$.

It's unavoidable that ROF loading outline will change occasionally due to loading vehicle and track vibration problems (Lei & Rose, 2008). It's necessary to set a safety allowance δ (mm) for the gap distance. The safe clearance constraint between loading outline \mathbf{H} and the minimum comprehensive structure gauge \mathbf{S}_{ij} should be expressed as $dis(\mathbf{H}, \mathbf{S}_{ij}) - \delta > 0$.

The objective function of ROF transport routing model for ROF-TRP is the total transport cost determined mainly by its total distance and out-of-gauge grade. The total distance of ROF transport route is $\sum(x_{ij}d_{ij})$ (km), and d_{ij} is the distance between two adjacent stations p_i and p_j . The total transport cost can be further rewritten as $\omega\mu\sum(x_{ij}d_{ij})$, and ω , μ represent the freight's weight (ton) and transport price per ton-kilometer (¥/t·km) respectively.

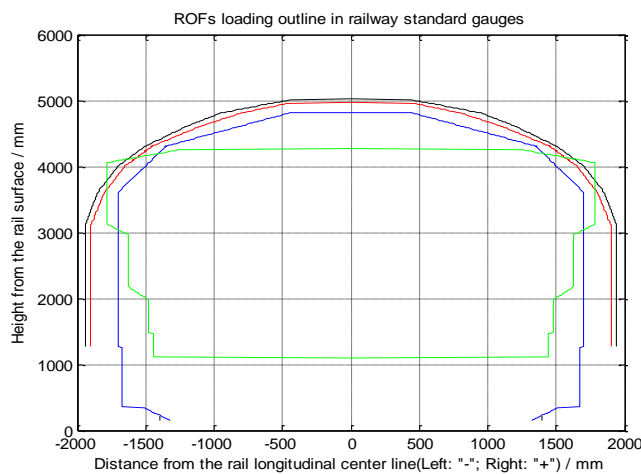

Figure 5: Railway standard gauges and ROF out-of-gauge grades

Transport price per ton-kilometer μ may rise due to features of railway freights and the gap distances. For ROF transportation, its price floating ratio ε is different according to the oversize extent and gap distances between loading outline and railway standard gauges, measured by out-of-gauge grades. As shown in Figure 5, if ROF loading outline (the green lines) is between the vehicle gauge (the blue lines) and the first standard gauge (the red lines), ROF is subordinate to the first out-of-gauge grade; if ROF loading outline is between the first standard gauge and the second standard gauge (the black lines), ROF is subordinate to the second out-of-gauge grade; if ROF loading outline is beyond the second standard gauge, ROF

is subordinate to super out-of-gauge grade. Although different parts at the ROF may have different out-of-gauge grades, the most severe one is taken as the final judgment criteria. As shown in Figure 5, ROF loading outline is beyond the second standard gauge at the height of 4,000 mm, which is the most severe one, thus, it's a super out-of-gauge cargo. Bigger the out-of-gauge grade, higher the floating ratio; the floating ratio has an upper bound. Thus, the basic transport cost $f(o, d)$ (unit: ¥) can be calculated by $f(o, d) = \omega\mu(1 + \varepsilon) \sum (x_{ij}d_{ij})$.

Taking the minimum transport cost as the optimal objective function, a ROF transport routing model with the constraints of flow balance and railway safety clearances can be formed as,

$$\min f(o, d) = \omega\mu(1 + \varepsilon) \sum (x_{ij}d_{ij}) \quad (2)$$

Subject to

$$\sum_{i \in \varphi(i)} x_{ij} - \sum_{j \in \beta(i)} x_{ij} = \begin{cases} 1 & i = o \\ 0 & i \neq o, d \\ -1 & i = d \end{cases} \quad (3)$$

$$dis(\mathbf{H}, \mathbf{S}_{ij}) - \delta > 0 \quad (4)$$

There are millions of infrastructures related to railway gauges in the whole railway network, and it's impossible for railway out-of-gauge dispatchers to check all gauges of intersections for each ROF transport task, which will take a long time to find all controllable locations at railway infrastructure in the whole rail network. The ideal solution of above model is to find some possible ROF transport routes firstly, gained by the k-shortest algorithm (Eppstein, 1998) from its origin and destination stations, and then check the minimum gap distance and clearances between ROF loading outline and railway gauges along these possible routes.

Under ideal conditions, ROF loading outline should be within all minimum comprehensive structure gauges at all intersections along its route. But it's not the situation for some ROFs safety transport. Railway structure gauges are fixed and unchangeable and it may be difficult to find a safe path for these ROFs whose loading outlines are beyond the railway structure gauges too much. And thus, there may be no feasible safe path from ROF's origin station and its destination station. It's also mean that railway companies cannot complete such ROF transport safely. However, railway companies have to organize and complete the task because most of ROFs are key infrastructures for national economy and defence construction and these tasks are often assigned by the government. In such case, railway companies have to carry out some costly railway infrastructures temporary maintenance projects in advance to remove or enlarge controllable infrastructures, i.e., railway signal equipment located at rail intersections, along selected routes in order to provide safe clearances and make out-of-gauge trains pass through them safely. In some situations, when out-of-gauge trains have passed them, these controllable infrastructures may be rebuilt to its normal conditions. If there are larger gaps or gauges criteria during original rail infrastructure development and maintenance projects, temporary controllable infrastructures maintenance tasks can be reduced greatly.

In addition, the safety clearance requirements for railway freight transport can be concluded by the case example of ROF-TRP and the gap distances between ROF loading outline and the minimum infrastructure structure gauges can be also gained (Controllable infrastructures and

parts will be located), both of which can provide useful information for railway designers, engineers and managers in the design, construction and maintenance of rail infrastructures.

5. CASE STUDY AND DISCUSSION

There is a ROF transported from *Siping* Railway Station to *Jieji* Railway Station in China rail network. Its characteristics are as follows, weight: 55.00 ton, length: 13 200 mm, maximum height: 4 250 mm, maximum width: 3 660 mm. Also, its loading outline is shown in Table 2.

Table 2: ROF loading outline of the case study (mm)

Location	Higher height	Lower height	Half-width
Middle-center Height	4250	-	1231
1 st -side height	4050	3290	1780
2 nd -side height	3050	2170	1830
3 rd -side height	1970	1470	1750
4 th -side height	1470	1170	1400

Consideration of gap distances between ROF loading outline and railway standard gauges (please see Figure 5), it's a super out-of-gauge freight. Thus, the price floating ratio ε is 10% (its upper limitation). Taken the average price of China railway freight transportation in a given year as the ROF transport price per ton-kilometer $\mu = 0.1551$ ¥/t·km, the objective function can be rewritten as $f(o, d) = 55.00 \times 0.1551 \times (1 + 10\%) \sum (x_{ij} d_{ij}) \approx 9.38 \sum (x_{ij} d_{ij})$.

With the proposed method in the paper, there are three possible routes for such transport tasks. R1 is *Siping - Zhengjiatun - Taipingchuan - Baicheng - Jieji*; R2 is *Siping - Changchun - Chuangchun North - Songyuan - Da'an North - Baicheng - Jieji* and R3 is *Siping - Zhengjiatun - Taipingchuan - Da'an North - Baicheng - Jieji*. After calculating gap distances and checking the clearance safety requirements, it's concluded that there are some unsafe intersections coloured with red in these possible paths, which further means that there are no large enough clearances for the out-of-gauge train passing them through safely.

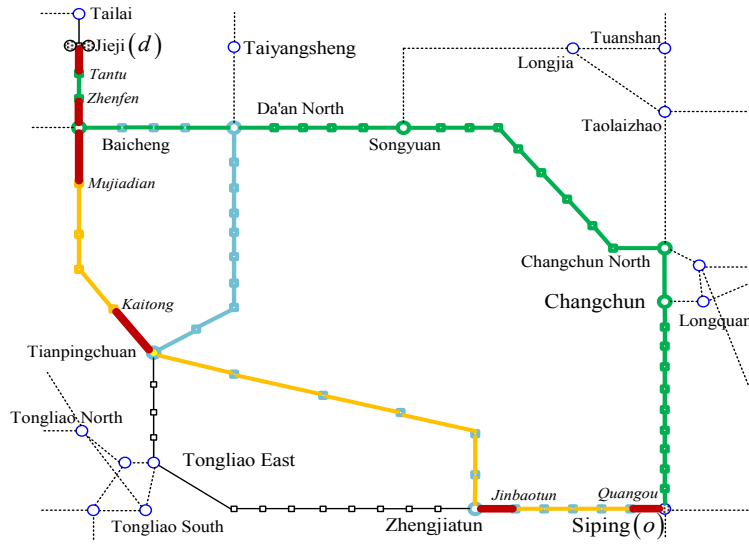

Figure 6: Possible ROF transport routes

Therefore, railway companies have to implement some necessary railway maintenance work or projects to remove or rebuild controllable infrastructures for rail safety transport. They have to gain some detail information of these unsafe infrastructures in advance. As for such case, they are located at railway intersections of *Baicheng-Zhenfen* and *Zhenfen-Jieji* in the longest route of R2, at the railway intersections of *Siping-Quangou*, *Jinbaotun-Zhengjiatun*, *Taipingchuan-kaitong*, *Majiadian-Baicheng*, *Baicheng-Zhenfen* and *Zhenfen-Jieji* in the shortest route R1 and at the railway intersections of *Siping-Quangou*, *Jinbaotun-Zhengjiatun*, *Baicheng-Zhenfen* and *Zhenfen-Jieji* in the route of R3 (as shown in Figure 6). Moreover, other related calculation results of these possible routes are shown in Table 3.

Table 3: Comparison of calculation results

ROF transport route	R1	R2	R3
Minimum gap distance (mm)	< 0	< 0	< 0
Other unsafe small gaps/clearances (mm)	1.00	1.00	1.00
	10.00	10.00	10.00
	12.00	12.00	12.00
	15.60	15.60	15.60
	19.00	19.00	19.00
Number/distance of safe intersections	14/310	30/666	24/488
Number/distance of maintenance intersections	6/134	2/51	4/79
ROF routing distance (km)	444	717	567
Values of the objective function (¥)	4164.72	6725.46	5318.46

If railway infrastructures gauges were big enough, there would be safe for all of these routes, which would mean that out-of-gauge trains carrying with these ROFs could run along with the shortest distances path (R1) and the total minimum transport cost were 4164.72 per ROF. Unfortunately, as shown in Table 3, there are 134 km with unsafe transport conditions in 6 railway intersections, 51 km with unsafe conditions in 2 railway intersections, and 79 km with

unsafe transport conditions in 4s intersections. Small gaps, i.e. less than 20.00 mm, leads to some unsafe clearances, which will impact ROF transport safety greatly. For each route, the number of railway intersections needing maintenances can be gained as shown in Table 3.

In addition, for making better railway infrastructures maintenance plans, more specific information of railway controllable infrastructures or parts should be gained. Figure 7 shows the locations of unsafe clearances or gaps at certain equipment between *Baicheng-Zhenfen*. The unsafe railway infrastructure parts whose gap distances are less than 0 are shown as red crossings in Figure 7, which also means that ROF loading outline is beyond railway gauges at these infrastructures and the train cannot pass them through safely. Also, controllable locations with unsafe clearances, i.e. 1 mm, 10 mm, 19 mm, can be shown in Figure 7. With such information, railway engineers can get more clear maintenances aims and criteria, i.e., the location of these unsafe controllable infrastructures and requirements for new safe railway infrastructures gauges, in the railway infrastructures maintenance projects or schemes.

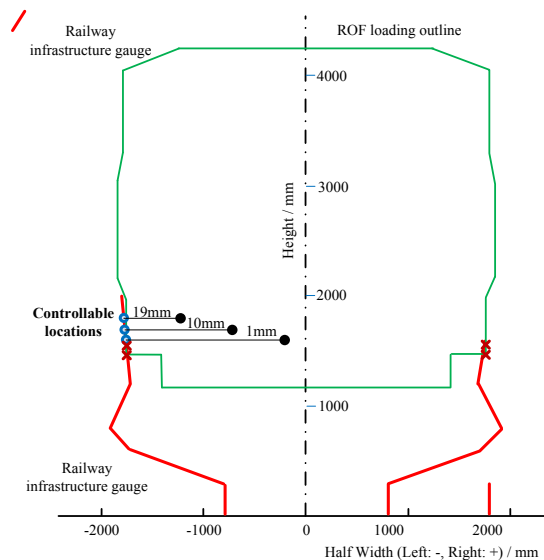

Figure 7: Locations of unsafe clearances at the intersection *Baicheng-Zhenfen*

From above analysis, it's concluded that that distances between vehicles and infrastructures are major factors that can impact on ROF transportation safety. Besides, with the proposed methodology, some useful information, i.e., detail intersections and mileages of controllable infrastructures and locations with unsafe clearances for such transport task, can be gained for railway infrastructures maintenance projects to guarantee railway transport safety. Specific bridges, tunnels, platforms, signal equipment or over-head power lines can be also achieved from the analysis of the minimum comprehensive structure gauge, which consists of railway bridges gauges, tunnels gauges and other infrastructures gauges. As for such case, the passing platform at *Baicheng* Railway Station is needed to be maintained to widen rail infrastructure structure gauge for ROF safety transport. With these useful information, railway designers, engineers and managers can make better railway infrastructures maintenance plans for safety.

Once railway infrastructures have been designed and constructed, railway gauges will be fixed and unchanged. For ROF safety transportation, railway companies often have to spend much more money and human resources to maintain them for safe clearances during the railway system operation phase. It's much easier and more convenient for railway companies to take such factors into consideration during railway infrastructures design and construction phases,

which can save costs and human resources greatly. Nowadays, more and more ROFs with different characteristics are becoming main sources of railway freights due to its lower transport cost and higher secure level. Therefore, in order to implement ROFs transport tasks safely, reduce transport and maintenance cost and improve freights volume for railway companies, ROF safety transportation based on gap distances or safe clearances should be integrated into the design, construction and maintenance projects of railway infrastructures.

6. CONCLUSIONS

First, controllable railway infrastructures with unsafe clearances can be gained precisely and useful information about safe clearances requirements and gap distances criteria for railway infrastructures maintenance projects at railway intersections along ROF safe transport routes can be also gained from the results. Railway companies can apply the proposed method in the paper to make decisions about ROF-TRP and necessary infrastructures maintenance projects. Second, railway gauges double-checking algorithm can avoid discarding controllable parts and equipment with high potential risks which may be neglected by railway out-of-gauge dispatchers, which can also provide useful information for railway designers, engineers and managers in the design, construction and maintenance of railway infrastructures. Thus, ROF safety transportation requirements should be taken into consideration in railway infrastructure design, construction and regular maintenance projects. Such considerations can help reduce unnecessary costly temporary maintenance projects, which may be the last choice for railway companies to transport ROFs safely assigned by the government. More detail safe clearance requirements based on ROF transport for specific railway infrastructures, i.e. bridges, tunnels, platforms, signal equipment and etc., should be further analysed and quantified for railway infrastructure development and maintenance projects, which are out next research tasks.

7. ACKNOWLEDGEMENTS

This study is funded by the National Key Research and Development Programme of China (2016YFB1200401), National Natural Science Foundation of China (71501190 & 61374157) and Beijing Jiaotong University State Key Laboratory of Rail Traffic and Control and Safety (RCS2017K001 & RCS2016ZT016). The support of the China Scholarship Council is also gratefully acknowledged.

8. REFERENCES

- Zhang, Y., Zeng, Q. F., Lei, D. and Wang, X., 2016, *Simulating the effects of non-crossing block sections setting rules on capacity loss of double-track railway line due to the operation of out-of-gauge trains*, *Discrete Dynamics in Nature and Society*, 2016(3), pp. 1-16.
- An, M., Lin, W. and Stirling, A., 2006, *Fuzzy-reasoning-based approach to qualitative railway risk assessment*, *Proceedings of the Institution of Mechanical Engineers, Part F: Journal of rail and rapid transit*, 220(2), pp. 153-167.
- An, M., Chen, Y. and Baker, C. J., 2011, *A fuzzy reasoning and fuzzy-analytical hierarch process based approach to the process of railway risk information: A railway risk management system*, *Information Science*, 181(18), pp. 3946-3966.
- An, M., Qin, Y., Jia, L. M. and Chen, Y., 2016, *Aggregation of group fuzzy risk information in the railway risk decision making process*, *Safety Science*, 82(2), pp.18-28.

- Johnson, D.M., 2008, *An analysis of railway system gauge proving using trains equipped with polystyrene blocks*, Proceedings of the Institution of Mechanical Engineers, Part F: Journal of rail and rapid transit, 222(3), pp. 267-273.
- Wilson, B.C., 2008, *A gauging strategy for Great Britain*, Proceedings of the Institution of Mechanical Engineers, Part F: Journal of rail and rapid transit, 222(3), pp. 227-233.
- Tang, B., Lei, D. and Zhang, Y., 2012, *Integrated optimizing model and algorithms of transportation route in out-of-gauge and overweight freights of railway*, Application Research of Computers, 29 (8), pp. 2876-2881.
- Wang, X., 2012, *Optimization research on running organization of railway out-of-gauge freight trains*, PhD dissertation, Central South University, Changsha.
- Lei, X. and Rose, J. G., 2008, *Track vibration analysis for railways with mixed passenger and freight traffic*, Proceedings of the Institution of Mechanical Engineers, Part F: Journal of rail and rapid transit, 222(4), pp. 413-421.
- Perez, J., Allen, P.D. and Hatt, D.J., 2008, *Making maximum use of restrictive loading gauge as applied to friction damped freight vehicles*, Proceedings of the Institution of Mechanical Engineers, Part F: Journal of rail and rapid transit, 222(3), pp. 255-265.
- Tang, B., Lei D. and Zhang Y., 2012, *Integrated optimizing model and algorithms of transportation route in out-of-gauge and overweight freights of railway*, Application Research of Computers, 29 (8), pp. 2876-2881.
- Eppstein, D., 1999, *Finding the k-shortest paths*, SIAM Journal on Computing, 28(2), pp. 652-673.

TG81: GLOBAL CONSTRUCTION DATA

COMPARING THE PERFORMANCE OF THE CONSTRUCTION INDUSTRIES IN THE COUNTRIES OF THE G20 AS MEASURED BY ISIC F CONSTRUCTION AND THE UK BENCHMARK MODEL

S. Gruneberg

Dept. of Property and Construction, University of Westminster, 35 Marylebone Road, London NW1 5LS, UK

Email: s.gruneberg@westminster.ac.uk

Abstract: Construction output is comprised of contractors and their supply chain. Using ISIC F Construction and the UK benchmark model (UKBM) serves to distinguish the value added on site by contractors and the supply chain. This serves to demonstrate the process of labour substitution that has been taking place in construction from 1970 to 2015. The per capita construction output of the construction industries of the members of the G20 is used to compare performance. Published data relies on data used to find the contribution of each sector of the economy. This approach measures value added, which is a perfectly valid approach for national income accounting. Unfortunately the value added measure of construction activity understates the contribution of the construction industry to the economy as a whole. This is because an increasing proportion of the value of construction is brought to site and merely assembled there. The UKBM includes the construction supply chain and enables construction to be compared internationally. This exercise demonstrates the labour substitution process taking place in the global construction sector. Using construction output per capita also shows how different countries have performed since 1970.

Keywords: Construction Industry Output, G20, International Comparison, ISIC F Construction, UK Benchmark Model

1. INTRODUCTION

Published national construction statistics are not consistent. Indeed, it could also be argued that they are not reliable or accurate. This poses a major difficulty when attempting to make international comparisons. Differences in defining terms and measuring output, differences in the roles, duties and responsibilities of the various participants all add to this confusion at an international level. If that is indeed the case, then one might well conclude that there is little point in referring to published data at all. In fact this is not the case. Even though international data may not be perfect, it nevertheless forms a starting point for discussion and debate. In other words the data is indicative of the scope of activities, the economic size of the industry and the relative performance of contractors. This can act as a starting point for discussion, policy making and strategy. Indeed, it can also serve to raise questions about the data itself and begin the process of examining change over time.

2. LITERATURE

Several authors have attempted to raise the issue of international construction measures, including Drewer (1980), Bon (2000), Ruddock and Lopes (2006), and Meikle and Gruneberg (2015). All of these authors have taken one or other aspect of construction and attempted to compare results from an international point of view. One problem in measuring construction output in all of these papers is that the common perception of what is actually measured bears little resemblance to what is actually delivered. To overcome the inconsistencies in construction data a UK Benchmark Model (UKBM) can be used to estimate and compare the

construction industries of different countries. The UKBM makes use of the advances made in re-classifying economic activities consistently and internationally through NACE Rev 2 and ISIC Rev 4, under the auspices of the UN to produce a global system of measuring the national income of every country.

Measurements of construction output are usually taken from the National Income accounts of each country. Estimates of construction output are usually based on the value added by each industrial sector to the inputs from other industries. By summing the value added from each industry, a grand total of every sector's value added is equivalent to the national income. This is a perfectly reasonable approach to finding the total size of an economy but only considers the value added by any one industry to the material and other inputs from elsewhere. Hence the total value of construction is only the value of what contractors and subcontractors add on site to the materials and professional services provided by the supply chain. This method of calculating the value of construction output therefore appears to understate the size of the construction sector and reduces its importance to the economy and to policy makers. This value added measure of construction is relevant for finding the national income of a country as it avoids double counting. It does not give an appropriate measure of the economic significance of the final output of construction to the rest of the economy.

Total construction output in the national income accounts includes new build and repair and maintenance. In the alternative measure of construction given in the gross fixed capital formation (GFCF) tables of the national income accounts, only new build is included. It is gross fixed capital as it is investment expenditure before depreciation has been deducted. The UKBM uses the construction industry component of GFCF as this uses the expenditure measure including the value of the inputs. To estimate total construction in the UKBM, repair and maintenance must be added to the new build data of GFCF to find total building output. In the UK repair and maintenance is approximately 40 per cent of construction output. This can be found by using the ratio of new build to total construction output found in UK Construction Statistics Table 2.8, published annually. The inverse of this ratio becomes the coefficient of new build in the UK National Income Accounts GFCF Table 9.5 to find the value of construction output, including the adjustments for both repair and maintenance and the whole supply chain.

The benchmark modelling approach described above improves the comparability of construction industries in different countries and gives a more intuitive measure of construction output than one based on value added. At present the value added measure of construction output understates the size of construction and its relative importance to the economy, with the result that when the construction industry is stimulated by investment the impact of that investment is invariably greater than anticipated. This can lead to shortages of skills and materials and the consequent increase in costs, delays and disputes. Although it has often been argued that the construction multiplier is responsible for stimulating the economy, in fact it is the hidden element of construction namely its supply chain emanating from manufacturing and materials industries that impact on the economy rather than any multiplier effect.

In the absence of a single consistent measure of construction activity in different countries around the world a benchmark model, such as the UKBM, can be devised to facilitate the comparison of construction performance throughout the world. This model uses UK construction data but any country's data could potentially be used for the same purpose. The benchmark simply enables all countries to have a common denominator for the purpose of making international comparisons. Indeed, it would be possible to take an average of a number

of countries to establish a common benchmark model based on a basket of national construction industries.

Currently the nearest concept to a universal measure of construction is based on the value added on site by contractors. This is because value added is used to calculate national income, which is the aggregate of the value added of all industries and sectors of the economy, including construction, iron and steel, mineral aggregates, concrete and cement, timber and timber products, glass and brick production. Unfortunately, this approach, which in itself is perfectly valid for measuring the whole economy, relegates construction to simply measuring the value added to all the materials and components, including the prefabricated components, by the contractors.

This means that the construction industry is comprised of the services rendered by a relatively few individuals and firms, who assemble building materials and components on site. This may have been an appropriate measure in the past when raw materials were brought onto site and made up and fashioned on site. Modern methods of construction use prefabrication and on site assembly to speed up the process, ensure consistent quality, improve safety during the construction process and reduce the need for labour. The statistical measurement of construction has not kept up or adapted to the changes that have taken place on site.

Skills and labour requirements have changed and look certain to continue on the same path in the years to come as prefabrication, Building Information Management (BIM) and 3-D printing are indicative of the potential for change in the industry. As a result it becomes necessary to adapt the measurement of construction to meet new circumstances. To that end a new model of the construction industry could be usefully employed to reflect the economic significance of the construction industry.

This is not to say that the value added approach is completely redundant. There remains a need to calculate the value added approach for the sake of calculating the national income but this is a narrow purpose, important as it is. It is only a device for measuring all activities in the economy. The problem with the construction sector is that the value added approach does not measure the total contribution of construction to gross domestic product as it misallocates the materials used and the contribution of the professionals engaged in the process such as engineers and architects to other industrial classifications in the economy. These objections to the value added approach can be overcome to a certain extent by using a benchmark model approach in addition to the International Standard Industrial Classification F Construction (ISIC F).

The benchmark model approach uses one or more countries to assess the breakdown of construction by type of output, type of firm and value of output, where these or equivalent data is gathered. The national income accounts published by the World Bank and the UN measure the national incomes of each country globally and consistently. The statistical international link enabling construction industries in different countries to be measured can be found using the gross fixed capital formation (GFCF) data in the national income accounts, which contains an alternative measure of construction, based on expenditure on new buildings and infrastructure but excluding repair and maintenance. Fortunately, repair and maintenance can be modelled using construction industry data, which can then be added to the value of new build in the GFCF tables. The value of GFCF is published by the World Bank and the United Nations. Using this data combined with the national construction data of the benchmarked construction industry, enables a consistent approach to construction output in different countries to be modelled. To illustrate the techniques used in the UK Benchmark Model (UKBM), the

countries of the G20 have been used as an example of how such a comparison can be achieved. UK construction data is used to form a common set of construction statistics and coefficients in the model. More specifically, construction output per capita has been used here to compare the G20 countries.

The G20 countries are Argentina, Australia, Brazil, Canada, China, France, Germany, Italy, India, Indonesia, Japan, South Korea, Mexico, Russian Federation, Saudi Arabia, South Africa, Turkey, United Kingdom and the United States. The European Union is also a member of the G20 but has not been included in this analysis of member states. Not all countries have been used in this paper due to space constraints.

In their paper on offsite construction or modular building Vernikos, Nelson, Goodier and Robery, (2013), discuss the literature of the size of the offsite construction market and from the literature estimate the volume of offsite construction to be £2.2bn in 2004 out of a construction market of £106.8bn, with offsite construction growing to between £4bn and £6bn by 2009. The impact of offsite construction refers to modular building only and does not take into account the building components which are also manufactured off site. According to the Construction Products Association (2017) web site the value of building components accounts for over £55bn annually. This suggests the following hypothesis: that ISIC F grows more slowly than the UKBM, if the value of output reflects all the components of the construction process (UKBM) and not just the value added on site, ISIC F.

3. METHODOLOGY

In order to model the construction industries of different countries, a common method is required. This was achieved using a method entitled the UK Benchmark Model (UKBM). This was found by using national income accounts data in combination with the UK construction statistics. The specific table used in the national accounts was the gross fixed capital formation, which represents the annual investment in plant and machinery and the built environment. GFCF is an expenditure measure of investment and therefore is the market price of real investment less taxes and subsidies. The UKBM was then compared to published data in the form of ISIC F, which is given in UNStats and is used as the conventional international measure of national construction activity.

To model total construction output in different countries, gross fixed capital formation (GFCF) is used. In principle GFCF measures new values only, such as new build. However, total construction output is comprised of new build and repair and maintenance. The first step in building the benchmark model is to estimate total construction output from new build alone and then find the coefficient needed to estimate total construction output. Taking UK construction data as an example, the UK benchmark model refers to Table 2.8 Private contractors: Value of work done by trade of firm and type of work (Office for National Statistics). Table 2.8 presents new build and repair and maintenance, which enables the percentage share of each to be estimated.

GFCF is comprised of new plant and machinery and new construction. The next step is therefore to find the construction element of GFCF, which can be found by combining new dwellings, excluding land, and other buildings and structures in Table 8.5 of the UK National Income Accounts. As these statistics refer to new build, the adjustment needed to find total output including repair and maintenance is the coefficient derived from Table 2.8 above.

The last step in the benchmark model is to find the coefficient of GFCF needed to estimate the value of construction from GFCF. To achieve this, the ratio of total build over GFCF is found and this becomes the coefficient of GFCF of country x to find the total annual construction output of country x . It is important to note that GFCF is an expenditure measure of construction. This means that it is found by calculating the value of investment in all new build, excluding land. This figure therefore includes materials and the whole construction supply chain. The benchmark model also includes repair and maintenance. For this reason the time series of the UK Benchmark model is greater than the ISIC F values, which are only based on the value added on site by contractors.

The GFCF of all countries can be found in UNStats. The coefficient of the ratio of construction to GFCF can be used to estimate annual construction output. Using the UKBM to estimate national construction output serves as an alternative to the ISIC F (Construction) output series, which is based on value added alone as published by the UN Statistics. This paper compares and contrasts both measures of construction output in the tables and graphs that follow and questions the continued use of value added by contractors to measure the contribution of construction to the economy.

In UK National Income Accounts Table 8.5 records gross fixed capital formation, total economy: analysis by type of asset, chained volume measures (reference year 2012). In Table 8.5 the new build element of GFCF is given as new dwellings, excluding land, and other buildings and structures. As this does not take repair and maintenance into account, an adjustment is needed to find total construction output. This can be estimated from UK Construction Statistics, Table 2.8 Private contractors: value of work done, by trade of firm and type of work. Table 2.8 gives a breakdown of total output by new build and repair and maintenance. As new build to total construction output is x/y , where x is new build and y is total construction, $1/(x/y)$ is the coefficient of the new build element in GFCF, according to the benchmark model. In order to complete the model we find the ratio of total UK construction to UK GFCF. This ratio is then applied to the time series of GFCF data in the UNStats table, entitled, "GDP and its breakdown at constant 2005 prices in US dollars". This table provides data from 1970 to 2015. This table forms the basis of the analysis of the UKBM that follows. Also in the same UN table is the time series of ISIC F Construction, also at constant 2005 dollars. ISIC F is based on construction output data sent to the UN by member states. This time series has also been used in the figures that follow for comparison purposes.

A final adjustment to the data was made by taking per capita construction as an indication of the difference construction activity might be expected to have on the lives of the local populations in the difference countries. Moreover, the impact of a large construction sector may not be as great, if the population it serves is large. Assessing the performance of a national construction sector relates to the size of the population.

4. RESULTS AND DISCUSSION

In all the figures below the solid time series is the benchmark model. The second time series, shown as a dashed line, is derived from the UN published data based on the International Standard Industrial Classification F, which covers the construction sector, defined narrowly as contractors and specialist contractors only. In all the figures below the UKBM time series is greater than the published data, reflecting the fact that the benchmark data measurement

includes the supply chain. According to the data in Figure 1, the coefficient of the regression line of the Argentinean UKBM has a long run positive growth (4.769) while the ISIC F time series was in slow decline with -0.665. This is common in the figures below and reflects the gradual decline of the value of on site work compared to prefabrication.

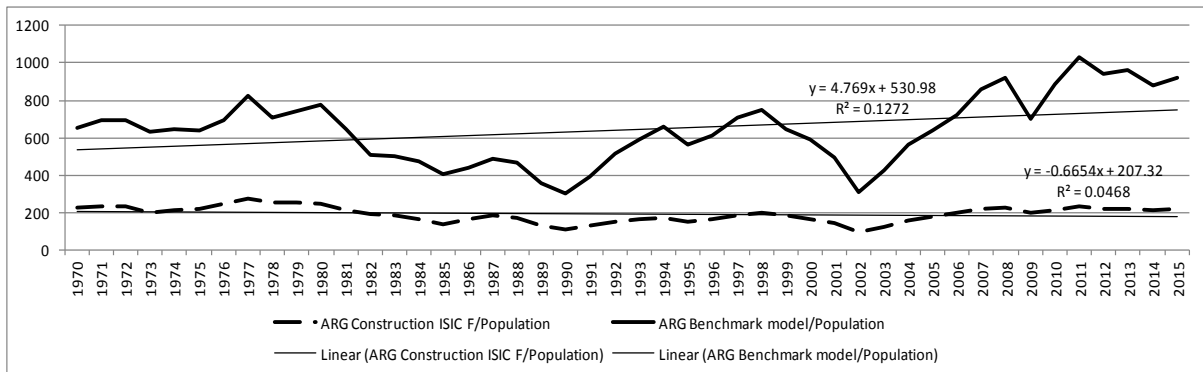

Note: Y-axis is per capita construction

Figure 1 Argentina: construction output at constant 2005 US dollars in 1970 to 2015

In all the figures, the growth rate of the UK benchmark model as measured by the coefficient of x in the regression line equations of both time series is greater than the published ISIC F data. In Figure 2 this tendency for the UKBM to grow faster than ISIC F indicates that as modern methods of building, which make use of prefabrication, and more sophisticated components are brought to site, the value added by contractors has provided a diminishing share of the work on site. Figure 2 confirms this pattern in Canada.

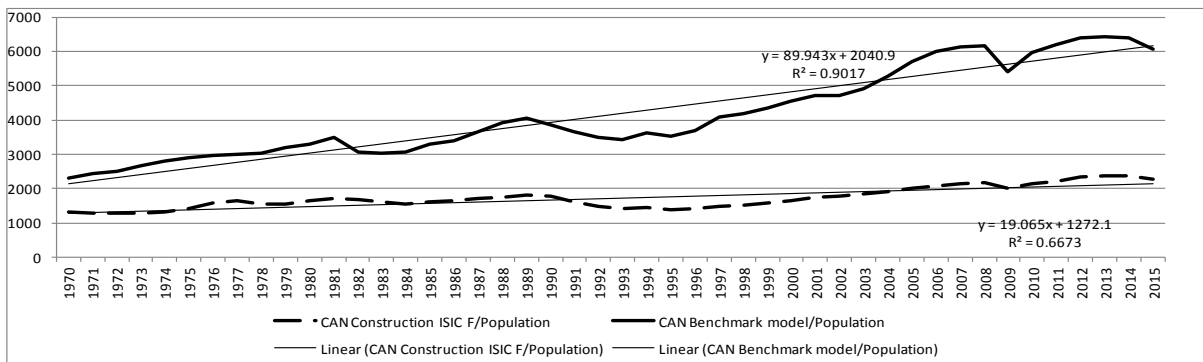

Note: Y-axis is per capita construction

Figure 2 Canada: construction output at constant 2005 US dollars 1970 to 2015

Similarly in Figure 3 the rapid growth in the value of construction output in China, appears to have come from the supply chain rather than the contracting side of construction. Figure 3 illustrates the problem of using exchange rates rather than purchasing power parities (PPP). Until around 1990, the value of construction per head in China was negligible but this was due to the artificially low exchange rate, (pegged to the dollar), and not what the state was able to obtain for its citizens. The reason is that the purchasing power of the renminbi in China was greater in China than suggested by the dollar exchange rate. As a result the value of Chinese construction output appears to be much smaller than it in fact was as these low values in per capita construction output did not reflect what Chinese citizens received.

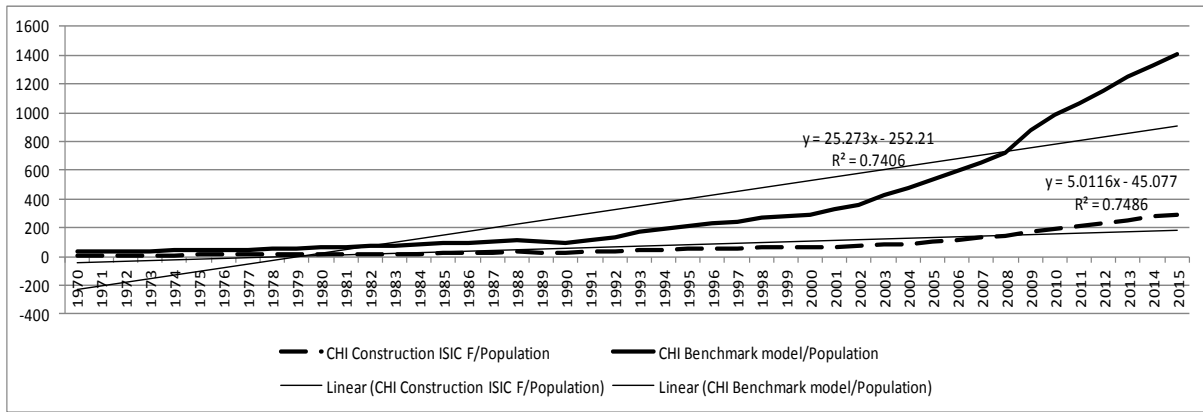

Note: Y-axis is per capita construction

Figure 3 China: construction output at constant 2005 US dollars, 1970 to 2015

Figure 3 shows the annual value of construction output in China increased after exchange controls were relaxed in 2005. The value of per capita construction output relative to income per head enabled Chinese consumers to purchase ever greater construction output commensurate with the purchasing power of average incomes. Bearing in mind that construction is not an internationally traded good, in terms of US dollars at 2005 prices construction output per capita in 1970 using the ISIC F measure was as little as \$9.94 and only \$34.28 according to the UK benchmark model. These figures had risen to \$285.98 and \$1,411.55 respectively by 2015, signalling a transformation of the Chinese construction market both in terms of prices and volume.

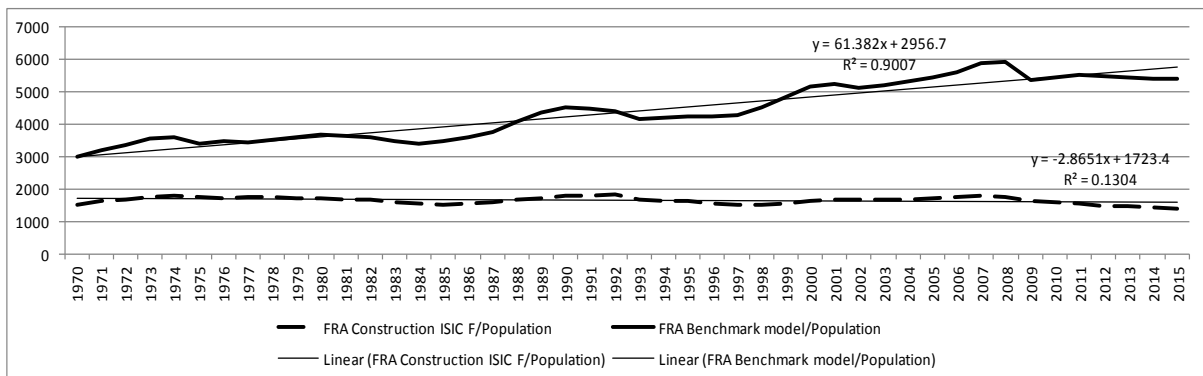

Note: Y-axis is per capita construction

Figure 4 France: construction output at constant 2005 US dollars, 1970 to 2015

Figures 4 and 5 show that France and Germany follow a similar pattern. For example, construction output in France continued to expand according to the UKBM, the value of output from contractors actually declined slowly over the years between 1970 and 2015, as prefabrication and modern methods of working increasingly replaced work on site.

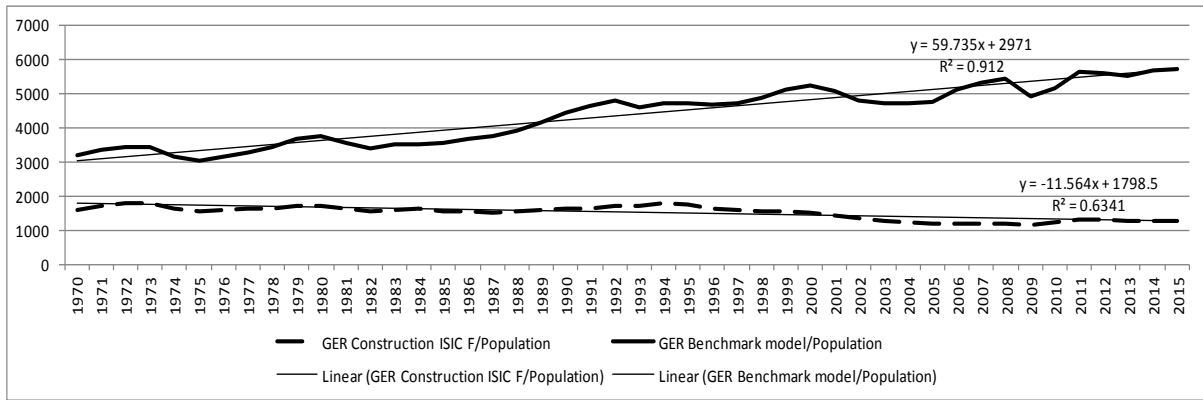

Note: Y-axis is per capita construction

Figure 5 Germany: construction output at constant 2005 US dollars, 1970 to 2015

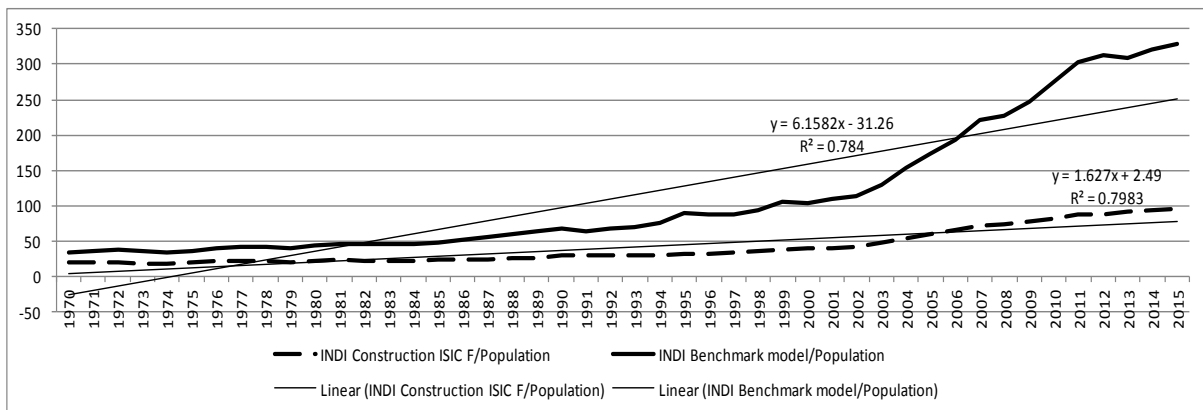

Note: Y-axis is per capita construction

Figure 6 India: construction output at constant 2005 US dollars, 1970 to 2015

Like China, the growth of construction output in India in Figure 6 can be seen in the growth of the benchmark model rather than the value added on site measured by ISIC F, further reinforcing the view that the final value of construction output is increasing at a greater rate than the value added on site.

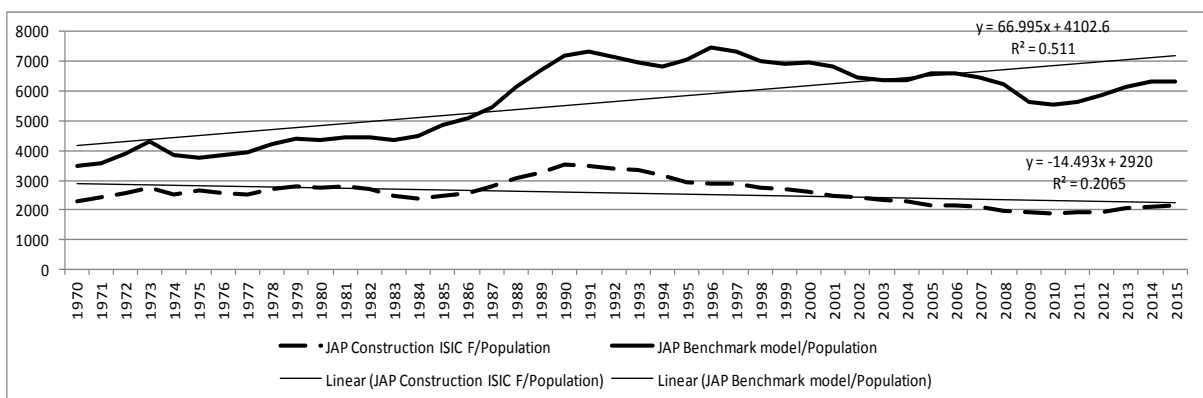

Note: Y-axis is per capita construction

Figure 7 Japan: construction output at constant 2005 US dollars, 1970 to 2015

In Japan the published ISIC F construction data shows a long run decline in construction whereas the UKBM measure of construction output grew although the period of economic stagnation is apparent from Figure 7. This can be interpreted as a decline in the value added on site but an increasing use of offsite construction over time.

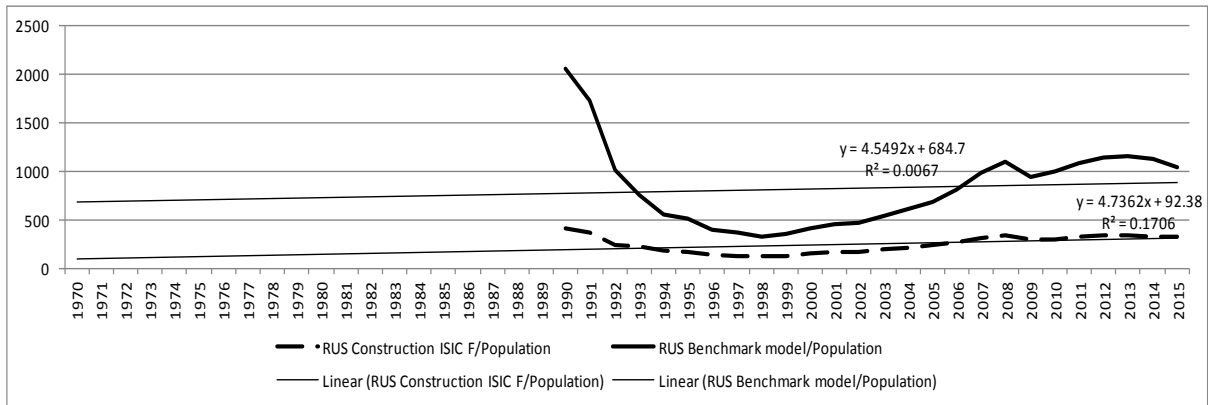

Note: Y-axis is per capita construction

Figure 8 Russian Federation: construction output at constant 2005 US dollars, 1990 to 2015

Figure 8 shows the decline and recovery of the construction industry in Russia since the collapse of the Soviet Union. As the construction industry recovered it performed just as the other G20 countries. The value added by contractors grew but at a slower rate than the construction sector taken as a whole. The growth of the UKBM was far faster than the growth of output of contractors.

Figure 9 shows the performance of construction in South Africa, where the UKBM series regularly exceeds the ISIC F time series by 3 to 4 times, possibly indicating a reliance upon imported materials and components.

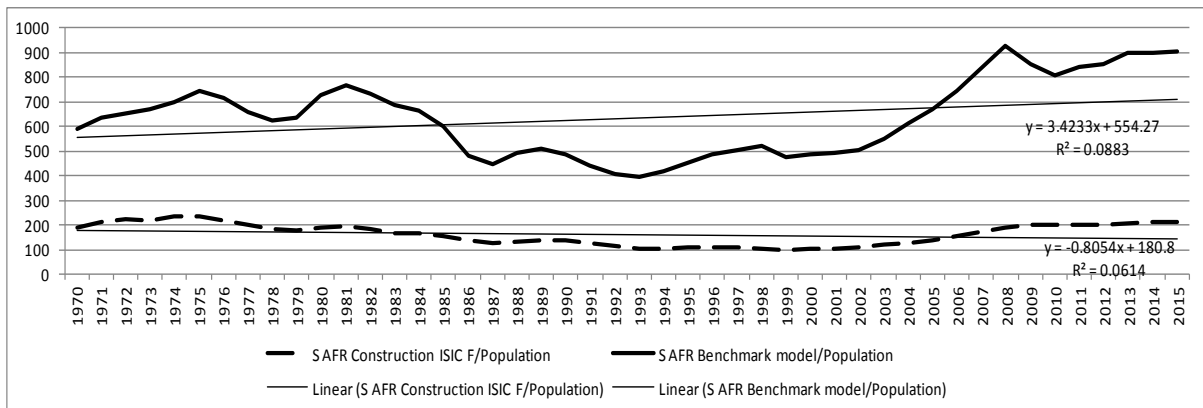

Note: Y-axis is per capita construction

Figure 9 South Africa: construction output at constant 2005 US dollars, 1970 to 2015

Figure 10 illustrates the performance of the UK construction industry since 1970. Since 1970 an increasing percentage of the total value of output is due to factors beyond the value added by contractors. Table 1 shows the ratio of the UKBM over ISIC F. This ratio represents the whole supply chain over the value added on site, rising from 1.39 in 1970 to 2.2 in 2015. In other words the supply chain is 1.39 to 2.2 times the size of value added on site. Table 1 also gives the equivalent ratios for the US. The US ratios grew from 1.22 in 1970 rising to 4.21 in

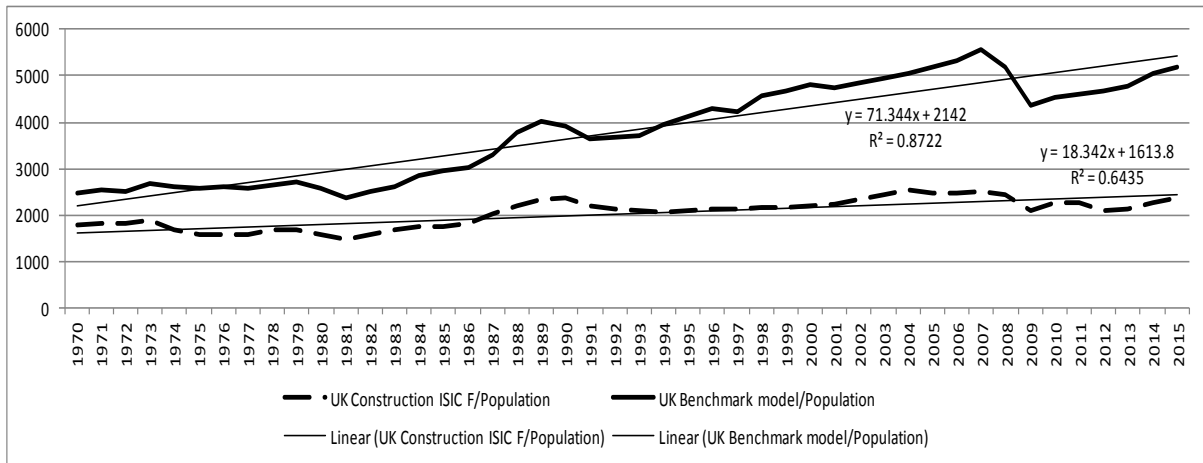

Note: Y-axis is per capita construction

Figure 10 United Kingdom: construction output at constant 2005 US dollars 1970 to 2015

2015 indicating that innovation in construction has been even stronger in the US than in the UK. A far higher proportion of the final price of construction emanates from the materials and components brought on to site in the US than in the UK.

Figure 11 reveals that while the conventional measure of US per capita construction output was in decline (based on ISIC F construction) the UKBM measure of construction showed a steady positive growth rate.

Table 1 Ratio of UKBM over ISIC F in the UK and US, 1970 to 2015

	1970	1975	1980	1985	1990	1995	2000	2005	2010	2015
UK: UKBM/ISIC F	1.39	1.62	1.63	1.69	1.64	1.97	2.19	2.10	2.01	2.20
US: UKBM/ISIC F	1.22	1.44	1.79	2.05	2.14	2.43	2.90	3.38	3.88	4.21

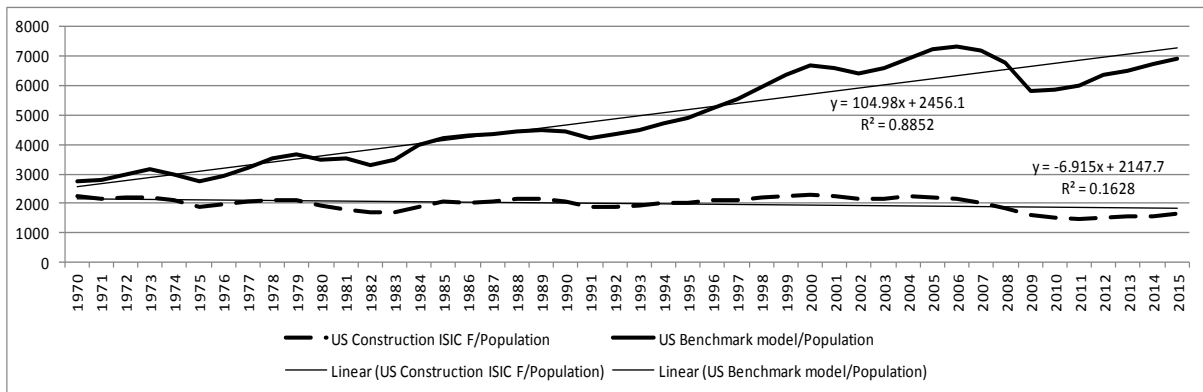

Note: Y-axis is per capita construction

Figure 11 United States: construction output at constant 2005 US dollars 1970 to 2015

5. CONCLUSIONS

Measuring productivity in construction is notoriously difficult in construction. As a result of these enquiries, it would appear that productivity on site as a function of value added on site has lagged behind the actual changes taking place. What has been happening is that there has been a process of labour substitution as an ever greater proportion of construction is delivered

to site only requiring final assembly or fixing. Moreover, labour substitution is taking place in all G20 countries, including those omitted from this paper.

Further research is required but it is clear that using the UK Benchmark Model is a potentially useful tool for comparing different countries and measuring national construction industries with a more intuitive approach that includes the materials and components and not just the services of contractors on site. Possible changes to the model would help to refine the results such as using purchasing power parities (PPPs) instead of exchange rates. Exchange rates were adopted here because of the use of exchange rates in the UNStats database. Also the use of UK data sets has been used only to demonstrate the possibilities of this benchmark approach to modelling construction data internationally. Using a basket of countries to estimate an average benchmark in each region of the world may produce a more acceptable basis for international comparison in the future.

6. REFERENCES

- Bon, R., (2000) *Economic Structure and Maturity*, Aldershot, Ashgate Publishing Ltd
- Construction Products Association (2017) <http://www.constructionproducts.org.uk/> Accessed 30th May 2017
- Drewer, S., (1980) Construction and Development: a new perspective, *Habitat International*, 5 (3), pp 395-428
- Gruneberg, S., (2008) *Modelling the UK built infrastructure market using gross fixed capital formation*, 24th Annual ARCOM Conference, Cardiff
- Gruneberg, S., (2011) The use of the UK Benchmark Model to develop a standard global approach to construction data, *Management and Innovation for a Sustainable Built Environment*, 20 – 23 June 2011, CIB, Amsterdam, The Netherlands
- Meikle, J and Gruneberg, S., (2015) “Measuring and comparing construction activity internationally”, in *Measuring Construction Prices, Output and Productivity*, eds R. Best and J. Meikle, Abingdon, Routledge
- Office for National Statistics, *Construction Statistics, Table 2.8 Private contractors: Value of work done, by trade of firm and type of work, Current Prices, Great Britain*, Newport
- Office for National Statistics, *National Income Accounts, 8.5 Gross fixed capital formation, Chained volume measures (reference year 2012), Total economy: Analysis by type of asset*, Newport
- Ruddock, L., and Lopes J., (2006) *The construction sector and economic development: the ‘Bon Curve’*, *Construction Management and Economics*, 24, pp 717-723
- Runeson, G., (2015) “Background to purchasing power parities”, in *Measuring Construction Prices, Output and Productivity*, eds R. Best and J. Meikle, Abingdon, Routledge
- UNStats (2017) United Nations Statistics Division (UNSD) www.unstats.un.org/home/
- Vernikos, V.K., Nelson R., Goodier C. I., and Robery, P.C., (2013) ‘Implementing an Offsite Construction Strategy: A UK contracting organisation case study’ in Smith, S.D and Ahiaga-Dagbui, D.D (Eds), *Proceedings of 29th Annual ARCOM Conference*, 2-4 September, Reading, UK, Association of Researchers in Construction Management, pp 667- 677

AGE COMPOSITION AND SURVIVAL OF PUBLIC HOUSING STOCK IN HONG KONG

Wai Kin Lau^{1*}, Kei Man Kelvin Ho¹, Terence Yat Ming Lam¹, Hon Chuen Ken Chan¹,
Tony Ma², Wing Kin Dennis Wu¹, Chi-wing Tsang¹

¹*Department of Construction Technology and Engineering, Faculty of Science and Technology,
Technological and Higher Education Institute of Hong Kong, Hong Kong*

²*School of Natural and Built Environments, University of South Australia, Adelaide, Australia*

* Email: wkela@vtc.edu.hk

Abstract: Emerging notably in more developed regions, building stock ageing which is characterised by shrinking new completions and falling “mortality” has been posing challenges to various stakeholders in built environment. To find way out of this transition, we need to know how long buildings will last these days and the factors leading to their “mortality”. By using data from 1950s till to date, a comprehensive investigation is conducted to analyse the age composition and life expectancy of public housing stock in Hong Kong. What comes after are survival analysis and empirical analysis of those demolished to identify the key factors leading to demolition. Presented in this paper are the preliminary findings as well as the research agenda on the theme to model age composition and survival of both private and public building stocks in Hong Kong and other similar cities in Asia Pacific Rim such as Adelaide and Singapore, together with research activities to formulate policies for sustainable urban management.

Keywords: Hong Kong, Kaplan-Meier Method, Life Table Method, Public Housing, Survival Analysis

1. INTRODUCTION

This paper is about age composition and survival of public housing blocks (PH blocks) in Hong Kong. It is a part of a research project to study survival of high-rise building stock in the Asia Pacific region. The grounds for this study are straightforward: at micro level, building owners and occupants will not be able to plan maintenance and refurbishment, or to make decisions such as to buy or to rent, if they have no knowledge of how long their properties will last, and at macro level, policy makers, government officials, developers, property and facilities managers, etc. often, if not always, experience difficulties to manage the existing and future building stock without knowing the key factors determining buildings’ lifespan. For sustainable urban management sake, this study is initiated to model composition and survival of high-rise building stock and to establish key factors that affect lifespan and demolition of buildings.

As a start, age composition and survival of public housing stock in Hong Kong was investigated and presented in this paper. In recent years, ageing building stock has become more concerned in Europe and its occurrence has just been realised in Asia. As many densely populated Asian cities are quite different from those in Europe, it is high time to examine the Asian case to know how long buildings there will last and the reasons of demolition. Probably one of the cities in the world with the highest portion of population housed in public housing, about 3.33 million, or 45.6% of Hong Kong’s population lived in public housing in 2015. Among them, 64.0%, or 2.12 million people, lived in 0.78 million units of public rental housing, and 36.0%, or 1.19 million people, lived in 0.4 million units of subsidised sale flats developed by Hong Kong Housing Authority (HKHA) or Hong Kong Housing Society (HKHS), the two major public housing agencies in the city (HKHA, 2016). Given the large amount of building stock in HKHA’s and HKHS’ portfolio, it is of great value to build a picture of Hong Kong’s ageing

building stock by first studying PH blocks. Apart from building stock itself is a subject of interest with manifold importance, the case of Hong Kong's PH blocks is interesting as most if not all housing blocks are owned and managed by HKHA and then HKHS. Knowing age distribution and survival of PH blocks will definitely help the management of existing stock, as it provides information for prediction of new completions and demolitions, formulation of management strategies and policies, etc.

The organisation of this paper is as follows. First published works relating to the subject of ageing building stock, survival analysis and demolition will be reviewed in brief. Then Kaplan-Meier method and the life table method to be used for survival analysis of Hong Kong's PH blocks will be described and explained, followed by the findings and a discussion. This paper ends with conclusions, limitations and follow-up research activities.

2. AGEING BUILDING STOCK, SURVIVAL ANALYSIS AND DEMOLITION

Emerging notably in more developed regions and sooner or later currently developing regions, building stock ageing is characterised by falling mortality and shrinking new completions, not to mention a higher mean age. This transition has caught attention in European countries and studies on this topic were conducted in England (Meikle and Connaughton, 1994; Riley, 1973), Germany (Bradley and Kohler, 2007), Greece (Theodoridou *et al.*, 2011), Netherlands (Thomsen and van der Flier, 2009), Norway (Sartori *et al.*, 2008), Spain (Rincon *et al.*, 2013) and Switzerland (Aksözen *et al.*, 2017). Definitely it has been posing challenges to the built environment in different aspects. To find way out of this transition, it is practical to know how long buildings will last these days, their survival patterns, and the factors causing demolition.

Dated back to early 1980s, Gleeson (1981; 1984; 1985; 1986) was among the first to apply actuarial techniques (e.g. trend models and the life table method) to estimate survival, loss and expected useful life of housing in the United States. Later Johnstone (1994) and Komatsu *et al.* (1994) both applied the life table method to study respectively the mortality of buildings in New Zealand and Japan, and housing in New Zealand was found to last for 90 years while apartments and office buildings in Japan had an average life of 35 years and 51 years respectively. In Bradley and Kohler (2007), the use of undemolished stock samples to create a Kaplan-Meier estimator (KME) for analyzing urban building stock survivorship was proposed. And Aksözen *et al.* (2017) used a KME to assess mortality of domestic and non-domestic buildings in the city of Zurich. Notwithstanding quite some (e.g. Muller, 2006 and Gallardo *et al.*, 2014) called for or used dynamic stock modelling (DSM) to explore future activity levels, few (e.g. Sartori *et al.*, 2008) applied DSM to study dynamics and survival of building stock while others mainly used it to analyse energy consumption and material flow. Some such as Meikle and Connaughton (1994) and Huuka and Lahdensivu (2016) adopted descriptive approach rather than statistical survival analysis to study survival and demolition of buildings. Perhaps from a consumerism point of view, Meikle and Connaughton (1994) argued that buildings nowadays have to last for hundreds of years given the low demolition rate.

Demolition, which is closely associated with survival of buildings, has become more concerned only in recent years. Thomsen and van der Flier (2011) proposed a conceptual model of obsolescence and discussed the relations between obsolescence and demolition. Thomsen *et al.* (2011) raised several issues to be addressed. For example, what is the average lifespan and demolition rate in different countries and what makes the differences? What are the key motives of owners and related stakeholders behind demolition of different buildings? Liu *et al.* (2014)

conducted an empirical study in Chongqing, China to investigate determinant of buildings' lifespan. They proposed a hedonic model to test different factors relating to physical condition, location, neighbourhood characteristics, economics or policy. Their model, however, did not consider the impact of planning and development control on demolition and redevelopment.

3. THE KAPLAN-MEIER METHOD AND THE LIFE TABLE METHOD

The Kaplan-Meier (KM) method is a nonparametric survival analysis that estimates survival function from censored cases. The survival function, denoted by $S(t)$, gives the probability that the lifetime of a building T exceeds the specified time t :

$$S(t) = \Pr (T > t) \quad (1)$$

The survival curve that illustrates survival function is therefore a decreasing smooth curve beginning at $S(t) = 1$ at $t = 0$ and heads downward towards zero as t increases towards infinity (Kleinbaum and Klein, 2005). The survival curves of buildings are, nonetheless, step functions as time here is counted in years which are discrete positive whole numbers.

As for applying the KM method to analyse survival of buildings, a comprehensive account and derivation from KM formula was given by Aksözen *et al.* (2016):

Without censoring, survival function is a sum of probability at the time t_k with k observed failure times:

$$S(t) = \Pr (T > t) = \sum_{t_k > t} pr(t_k) \text{ with } k = 1, 2, 3, \dots \quad (2)$$

Where undemolished buildings are right censored, either the age when buildings are demolished or the age the standing buildings are up to will be used for calculation of KME. The lifetime demolished or undemolished buildings are up to is L and the practical lifetime of buildings from year of completion to end of observation is C . The observed lifetime of buildings is defined as:

$$T = \min\{L, C\} \quad (3)$$

If it happens that buildings have a lifetime L greater than/beyond the observation period, only the practical lifetime C which does not go beyond the observation period will be considered. For hazard function/rate, it is related but opposite to survival function as it focuses on failing. The survival function $S(t)$ and hazard rate $h(t)$ at each time t_k and its product until time t is given by:

$$\hat{S}(t) = \prod_{t_k \leq t} [1 - h(t_k)] \quad (4)$$

The survival function for building stock estimated by the KM method is:

$$S(t) = \prod_{t_k \leq t} \left(1 - \frac{D_k}{B_k + D_k}\right) \quad (5)$$

where D_k is the number of demolished buildings (i.e. the event concerned) that have survived t_k , and B_k is the number of buildings that have survived longer than t_k .

And the mean survival time is estimated by:

$$\hat{\mu} = \begin{cases} \sum_{i=0}^{k-1} \hat{S}(t_i^+) \times (t_{i+1} - t_i) & \text{If } T_L = t_k \\ \sum_{i=0}^{k-1} \hat{S}(t_i^+) \times (t_{i+1} - t_i) + \hat{S}(t_k^+) \times (T_L - t_k) & \text{otherwise} \end{cases} \quad (6)$$

with T_L being the largest observation time;

$T_L = t_k$ if T_L is uncensored;

t_a^+ is a right censored observation at time t_k ; and

$t_0 = 0$ and $\hat{S}(t_0^+) = 1$

Other than T itself must be known to calculate KME, status of buildings at T (either demolition (1) or no event (0)) is required. Besides, buildings are also grouped into different cohorts according to their years of completion to conduct the log-rank test to determine whether survival curves of two cohorts are statistically significantly different.

To apply the KM method, years of completion and demolition of PH blocks are needed. For the surviving stock, the required information can be obtained from the websites of HKHA (using the ‘‘Estate Locator’’) and HKHS, or from publications such as Rating and Valuation Department (RVD)’s *Names of Buildings* and HKHA’s Annual Report. For the demolished stock, a website called ‘‘Hong Kong Place’’ which is considered to be a credible source was referred in this study.

The period under consideration in this study is between 1951 and 2016. During this period, there were 2,467 PH blocks constructed and as of the end of 2016 1,702 blocks were still surviving and 765 blocks were demolished. Since the first PH blocks were built in 1951, the observation period is long enough to cover all surviving and demolished public housing stock and there is no need for left censoring. The events concerned are either ‘‘demolished’’ (1) or ‘‘survived’’ (0). Unlike other studies such as Aksözen *et al.* (2016) where survival of different building types was estimated, PH blocks of different tenure types are analysed collectively here. That said, the PH blocks are grouped into 5-year interval cohorts according to their years of completion to test whether PH blocks of different construction periods have different survival rates. For age of both surviving and demolished buildings, it is counted in years which are discrete positive whole numbers.

With much longer history, the life table method is another statistical tool for analysing survival. At centre of this method is construction of life table which is usually based on the manipulation of mortality rates (${}_nM_x$) and the translated mortality probabilities (${}_nq_x$), a survivorship curve (l_x) and life expectancies (e_x^0) (Anson, 2002). In Johnstone (1993, pp. 24-37), a derivation of this method was provided and explained. To estimate median survival time, cumulative proportion surviving at end, hazard rate, etc., a life table at 1-year interval is also constructed. In both survival analyses by the KM method and the life table method, Statistical Package for the Social Sciences (SPSS) Version 24 is used to conduct the analysis.

4. FINDINGS

The survival curves of PH blocks built in different periods are shown in Figure 1. As can be seen from (a), the survival function of all PH blocks dropped significant between the age of 25 and 35 suggesting that many demolitions occurred during this period. After that, the survival function heads downward gradually and stays above 0.2 when age goes beyond 50. This pattern is also observed in (b), (c), (d) and (e), i.e. PH blocks constructed between 1951 through 1970, but not in (f), as demolitions occurred earlier in this cohort after the age of 15 and maintained at similar rate until the age of 30. Beyond 30, demolition is rare in this cohort. For the rest cohorts, those shown in (g) and (h) included, their survival functions are at or close to 1.0 saying that only a few PH blocks built after 1975 were demolished. Whether the survival functions of PH blocks built in different periods are significantly different have to be further tested using the log-rank test, and this is going to be done in follow-up study. From Tables 1 and 2, the median for the survival time of PH blocks built between 1951 and 1975 varied between 29 to 34 years, and the median for the survival time of all PH blocks is 37 years. These figures are comparable to the estimated average life of buildings in Japan, viz. wooden residential at 38.2 years, reinforced concrete (RC) offices at 34.8 years and RC apartment at 50.6 years (Komatsu *et al.*, 1994) but far much younger than New Zealand's housing (Johnstone, 1994) at 90 years and buildings in the city of Zurich at 130 years (Aksözen *et al.*, 2016).

Regarding the age-specific mortality (equivalent to demolition or hazard) rates determined by the life table method (Table 3), such rates do not increase with age. When PH blocks survived 0 to 24 years, a zero or close to zero mortality (hazard) rate is observed. As PH blocks survived 25 to 53 years, the mortality rate becomes higher. The highest four age-specific mortality rates are 8% at ages 29 and 46, 11% at age 35, 16% at age 53 and 20% at age 51. Among the oldest old PH blocks, i.e. those survived more than 53 years, no demolition has been observed so far and thus the mortality rates beyond age 53 are all zero. In Figure 2, the survival curve plotted by the life table method is shown. As summary descriptive statistics, number of PH blocks by period of construction and demolition and by age of demolition is presented in Tables 4 and 5.

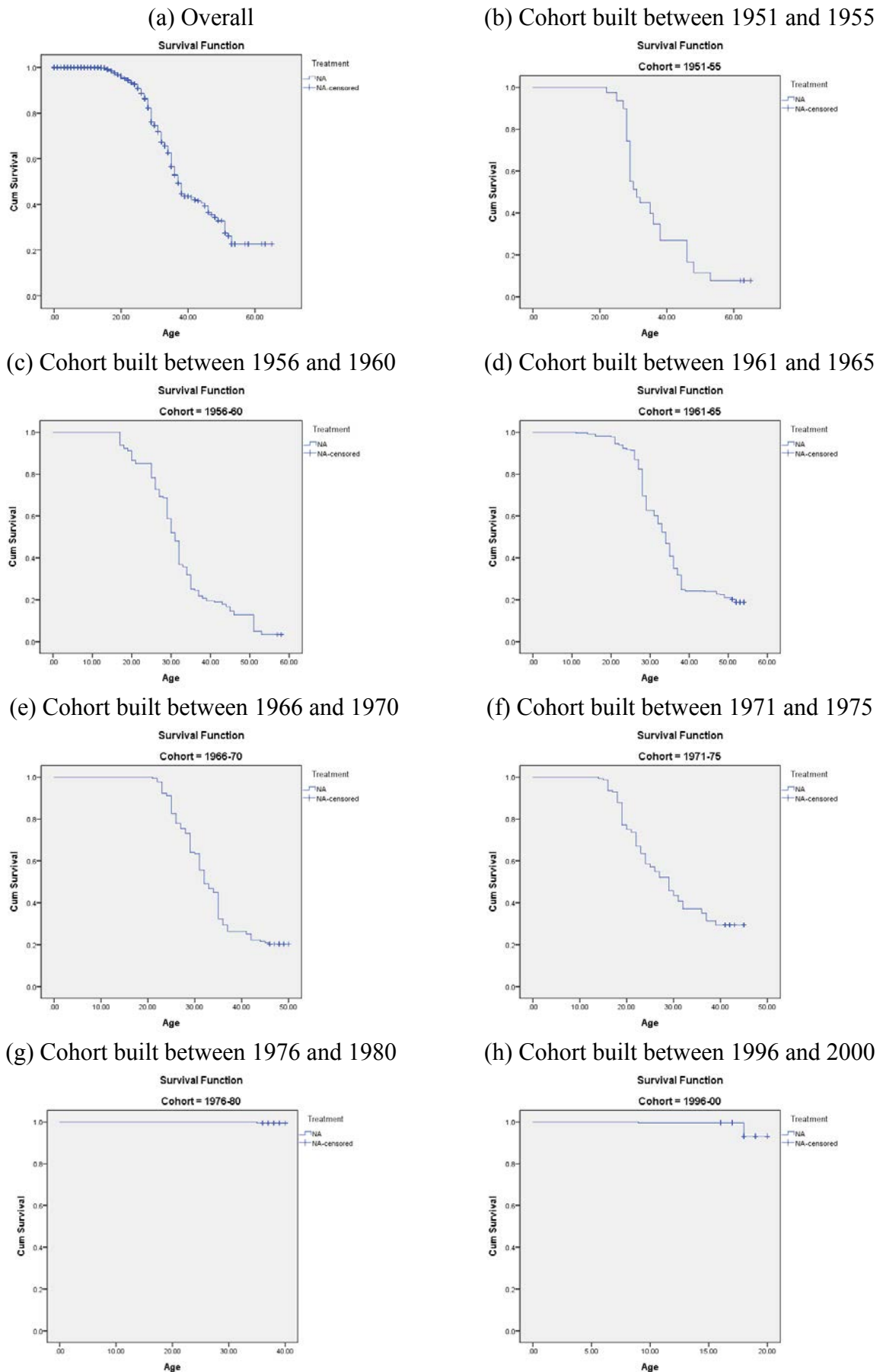

Figure 1: Survival curves of PH blocks built in different periods produced by the KM method

Table 1: Means, medians, confidence intervals and standard errors for the survival time of PH blocks (as of the end of 2016) estimated by the KM method

Cohort	Treatment	Estimate	Std. Error	Mean 95% Confidence Interval		Estimate	Std. Error	Median 95% Confidence Interval	
				Lower Bound	Upper Bound			Lower Bound	Upper Bound
1951-1955	NA	36.397	1.283	33.882	38.913	31.000	1.654	27.759	34.241
1956-1960	NA	32.648	0.769	31.142	34.155	31.000	0.514	29.992	32.008
1961-1965	NA	36.018	0.577	34.887	37.149	34.000	0.516	32.989	35.011
1966-1970	NA	34.737	0.706	33.352	36.121	32.000	1.077	29.890	34.110
1971-1975	NA	30.557	0.913	28.768	32.346	29.000	1.474	26.112	31.888
1976-1980	NA	39.970	0.30	39.912	40.028	-	-	-	-
1981-1985	NA	33.021*	-	-	-	33.000*	-	-	-
1986-1990	NA	27.703*	-	-	-	28.000*	-	-	-
1991-1995	NA	23.079*	-	-	-	23.000*	-	-	-
1996-2000	NA	19.817	0.72	19.677	19.957	-	-	-	-
2001-2005	NA	13.611*	-	-	-	14.000*	-	-	-
2006-2010	NA	7.701*	-	-	-	8.000*	-	-	-
2011-2016	NA	2.421*	-	-	-	3.000*	-	-	-
Overall	NA	42.245	0.511	41.243	43.247	37.000	0.383	36.249	37.751

* Mean/median found by simple calculation in the absence of event.

Table 2: Survival rate of PH blocks built in different periods (as of the end of 2016)

Period of Construction	Mean Age of PH Blocks (in years) (as of the end of 2016)	Median Age of PH Blocks (in years) (as of the end of 2016)	Survival Rate (in %)
1951-1955	36.4	31.0	7.7
1956-1960	32.6	31.0	3.4
1961-1965	36.0	34.0	19.4
1966-1970	34.7	32.0	20.4
1971-1975	30.6	29.0	29.3
1976-1980	40.0	-	99.4
1981-1985	33.0*	33.0*	100.0
1986-1990	27.7*	28.0*	100.0
1991-1995	23.1*	23.0*	100.0

1996-2000	19.8	-	96.0
2001-2005	13.6*	14.0*	100.0
2006-2010	7.7*	8.0*	100.0
2011-2016	2.4*	3.0*	100.0
All Cohorts	42.2	37.0	69.0

* Mean/median found by simple calculation in the absence of event.

Table 3: Life table of PH blocks at 1-year interval

Interval Start Time	Number Entering Interval	Number Withdrawing during Interval	Number Exposed to Risk	Number of Terminal Events	Proportion Terminating	Proportion Surviving	Cumulative Proportion Surviving at End of Interval	Std. Error of Cumulative Proportion Surviving at End of Interval	Probability Density	Std. Error of Probability	Hazard Rate	Std. Error of Hazard Rate
0	2467	28	2453.000	0	.00	1.00	1.00	.00	.000	.000	.00	.00
1	2439	17	2430.500	0	.00	1.00	1.00	.00	.000	.000	.00	.00
2	2422	6	2419.000	0	.00	1.00	1.00	.00	.000	.000	.00	.00
3	2416	26	2403.000	0	.00	1.00	1.00	.00	.000	.000	.00	.00
4	2390	16	2382.000	0	.00	1.00	1.00	.00	.000	.000	.00	.00
5	2374	21	2363.500	0	.00	1.00	1.00	.00	.000	.000	.00	.00
6	2353	11	2347.500	0	.00	1.00	1.00	.00	.000	.000	.00	.00
7	2342	21	2331.500	0	.00	1.00	1.00	.00	.000	.000	.00	.00
8	2321	29	2306.500	0	.00	1.00	1.00	.00	.000	.000	.00	.00
9	2292	12	2286.000	1	.00	1.00	1.00	.00	.000	.000	.00	.00
10	2279	4	2277.000	0	.00	1.00	1.00	.00	.000	.000	.00	.00
11	2275	33	2258.500	1	.00	1.00	1.00	.00	.000	.000	.00	.00
12	2241	29	2226.500	0	.00	1.00	1.00	.00	.000	.000	.00	.00
13	2212	39	2192.500	0	.00	1.00	1.00	.00	.000	.000	.00	.00
14	2173	35	2155.500	3	.00	1.00	1.00	.00	.001	.001	.00	.00
15	2135	103	2083.500	1	.00	1.00	1.00	.00	.000	.000	.00	.00
16	2031	58	2002.000	11	.01	.99	.99	.00	.005	.002	.01	.00
17	1962	32	1946.000	12	.01	.99	.99	.00	.006	.002	.01	.00
18	1918	36	1900.000	17	.01	.99	.98	.00	.009	.002	.01	.00
19	1865	36	1847.000	17	.01	.99	.97	.00	.009	.002	.01	.00
20	1812	30	1797.000	12	.01	.99	.96	.00	.006	.002	.01	.00
21	1770	40	1750.000	17	.01	.99	.95	.00	.009	.002	.01	.00
22	1713	29	1698.500	16	.01	.99	.94	.01	.009	.002	.01	.00
23	1668	54	1641.000	20	.01	.99	.93	.01	.011	.003	.01	.00
24	1594	12	1588.000	11	.01	.99	.93	.01	.006	.002	.01	.00
25	1571	56	1543.000	32	.02	.98	.91	.01	.019	.003	.02	.00
26	1483	59	1453.500	36	.02	.98	.88	.01	.022	.004	.03	.00
27	1388	100	1338.000	33	.02	.98	.86	.01	.022	.004	.02	.00
28	1255	94	1208.000	61	.05	.95	.82	.01	.044	.005	.05	.01
29	1100	34	1083.000	81	.07	.93	.76	.01	.061	.007	.08	.01
30	985	43	963.500	19	.02	.98	.74	.01	.015	.003	.02	.00
31	923	47	899.500	36	.04	.96	.71	.01	.030	.005	.04	.01
32	840	52	814.000	51	.06	.94	.67	.01	.045	.006	.06	.01

Table 3: Life table of PH blocks at 1-year interval (cont'd)

Interval Start Time	Number Entering Interval	Number Withdrawing during Interval	Number Exposed to Risk	Number of Terminal Events	Proportion Terminating	Proportion Surviving	Cumulative Proportion Surviving at End of Interval	Std. Error of Cumulative Proportion Surviving at End of Interval	Probability Density	Std. Error of Probability	Hazard Rate	Std. Error of Hazard Rate
33	737	44	715.000	20	.03	.97	.65	.01	.019	.004	.03	.01
34	673	39	653.500	29	.04	.96	.62	.01	.029	.005	.05	.01
35	605	56	577.000	59	.10	.90	.56	.01	.063	.008	.11	.01
36	490	63	458.500	33	.07	.93	.52	.01	.040	.007	.07	.01
37	394	27	380.500	26	.07	.93	.48	.02	.035	.007	.07	.01
38	341	23	329.500	32	.10	.90	.43	.02	.047	.008	.10	.02
39	286	32	270.000	7	.03	.97	.42	.02	.011	.004	.03	.01
40	247	22	236.000	0	.00	1.00	.42	.02	.000	.000	.00	.00
41	225	19	215.500	3	.01	.99	.42	.02	.006	.003	.01	.01
42	203	13	196.500	5	.03	.97	.41	.02	.011	.005	.03	.01
43	185	3	183.500	2	.01	.99	.40	.02	.004	.003	.01	.01
44	180	0	180.000	4	.02	.98	.39	.02	.009	.004	.02	.01
45	176	6	173.000	5	.03	.97	.38	.02	.011	.005	.03	.01
46	165	12	159.000	12	.08	.92	.35	.02	.029	.008	.08	.02
47	141	1	140.500	4	.03	.97	.34	.02	.010	.005	.03	.01
48	136	12	130.000	5	.04	.96	.33	.02	.013	.006	.04	.02
49	119	6	116.000	5	.04	.96	.32	.02	.014	.006	.04	.02
50	108	3	106.500	0	.00	1.00	.32	.02	.000	.000	.00	.00
51	105	27	91.500	17	.19	.81	.26	.02	.059	.013	.20	.05
52	61	12	55.000	3	.05	.95	.24	.02	.014	.008	.06	.03
53	46	13	39.500	6	.15	.85	.21	.02	.037	.014	.16	.07
54	27	15	19.500	0	.00	1.00	.21	.02	.000	.000	.00	.00
55	12	0	12.000	0	.00	1.00	.21	.02	.000	.000	.00	.00
56	12	0	12.000	0	.00	1.00	.21	.02	.000	.000	.00	.00
57	12	1	11.500	0	.00	1.00	.21	.02	.000	.000	.00	.00
58	11	5	8.500	0	.00	1.00	.21	.02	.000	.000	.00	.00
59	6	0	6.000	0	.00	1.00	.21	.02	.000	.000	.00	.00
60	6	0	6.000	0	.00	1.00	.21	.02	.000	.000	.00	.00
61	6	0	6.000	0	.00	1.00	.21	.02	.000	.000	.00	.00
62	6	1	5.500	0	.00	1.00	.21	.02	.000	.000	.00	.00
63	5	3	3.500	0	.00	1.00	.21	.02	.000	.000	.00	.00
64	2	0	2.000	0	.00	1.00	.21	.02	.000	.000	.00	.00
65	2	2	1.000	0	.00	1.00	.21	.02	.000	.000	.00	.00

Table 4: Number of PH blocks constructed and demolished in different periods

Period of Construction	No. of PH Blocks Constructed	No. of PH Blocks Demolished/Cohort Mortality Rate						No. of PH Blocks Surviving/ Cohort Survival Rate
		1971-1980	1981-1990	1991-2000	2001-2010	2011-2016	Total	
1951-1955	78	5 (6.4%)	46 (59.0%)	13 (16.7%)	8 (10.3%)	-	72 (92.3%)	6 (7.7%)
1956-1960	179	27 (15.1%)	77 (43.0%)	45 (25.1%)	21 (11.7%)	3 (1.7%)	173 (96.6%)	6 (3.4%)
1961-1965	346	7 (2.0%)	44 (12.7%)	174 (50.3%)	48 (13.9%)	6 (1.7%)	279 (80.6%)	67 (19.4%)
1966-1970	167	-	12 (7.2%)	74 (44.3%)	39 (23.4%)	8 (4.8%)	133 (79.6%)	34 (20.4%)
1971-1975	140	-	21 (15.0%)	46 (32.9%)	29 (20.7%)	3 (2.1%)	99 (70.7%)	41 (29.3%)
1976-1980	168	-	-	-	-	1 (0.6%)	1 (0.6%)	167 (99.4%)
1981-1985	238	-	-	-	-	-	-	238 (100.0%)
1986-1990	330	-	-	-	-	-	-	330 (100.0%)
1991-1995	191	-	-	-	-	-	-	191 (100.0%)
1996-2000	200	-	-	-	1 (0.5%)	7 (3.5%)	8 (4.0%)	192 (96.0%)
2001-2005	239	-	-	-	-	-	-	239 (100.0%)
2006-2010	77	-	-	-	-	-	-	77 (100.0%)
2011-2016	114	-	-	-	-	-	-	114 (100.0%)
Total	2,467	39	200	352	146	28	765	1,702 (69.0%)

Table 5: Number of PH blocks by period of construction and by age of demolition

Period of Construction	No. of PH Blocks Constructed	No. of PH Blocks by Age of Demolition/Percentage of Cohort						No. of PH Blocks Surviving
		≤20	21-30	31-40	41-50	>50	Total	
1951-1955	78	-	38 (48.7%)	19 (24.4%)	12 (15.4%)	3 (3.8%)	72 (92.3%)	6
1956-1960	179	24 (13.4%)	62 (34.6%)	58 (32.4%)	12 (6.7%)	17 (9.5%)	173 (96.6%)	6
1961-1965	346	8 (2.3%)	121 (35.0%)	133 (38.4%)	11 (3.2%)	6 (1.7%)	279 (80.6%)	67
1966-1970	167	-	61 (36.5%)	62 (37.1%)	10 (6.0%)	-	133 (79.6%)	34
1971-1975	140	35 (25.0%)	44 (31.4%)	20 (14.3%)	-	-	99 (70.7%)	41
1976-1980	168	-	-	1 (0.6%)	-	-	1 (0.6%)	167
1981-1985	238	-	-	-	-	-	-	238
1986-1990	330	-	-	-	-	-	-	330
1991-1995	191	-	-	-	-	-	-	191
1996-2000	200	8 (4.0%)	-	-	-	-	8 (4.0%)	192
2001-2005	239	-	-	-	-	-	-	239
2006-2010	77	-	-	-	-	-	-	77
2011-2016	114	-	-	-	-	-	-	114
Total	2,467	75	326	293	45	26	765	1,702

5. CONCLUSIONS

It is evident that buildings, especially those in more developed regions, are ageing. From recent studies, researchers worldwide are paying more attention on survival of ageing building stock, and factors affecting lifespan and demolition of buildings. As a start of a series of research to investigate survival of high-rise buildings in Hong Kong, age composition and survival of PH blocks are analysed in this paper. By using the KM method, survival functions of all PH blocks and PH blocks built in different periods are estimated. Many demolitions occurred when PH blocks were aged between 25 and 35. The estimated median for the survival time of all PH blocks is 37 years, and that for PH blocks built between 1951 and 1975 varied between 29 to 34 years. Demolition of PH blocks built after 1975 is nonetheless rare. Considered also is the number of PH blocks constructed and demolished in different periods and the age of the demolished blocks. Shrinking new completions and demolitions are confirmed.

Currently survival of public housing stock is analysed and studied in blocks. This setting, however, depicted only a part of the whole picture. More useful information regarding survival and age distribution of the public housing stock will be generated if gross floor area (GFA) and number of units of individual PH blocks are known and considered. Though all PH blocks built between 1951 and 2016 are studied, non-time-related parameters such as number of storeys, number of units, GFA, frequency/cost of maintenance, land price, geographical location, residual GFA, accessibility (e.g. connection to mass transit), etc. in respect of their mortality have not been taken into account in this stage.

Despite the above findings, factors that lead to demolition of PH blocks and things to be done to deal with the ageing public housing stock are to be investigated. For the former purpose, a statistical model will be developed to test the significant factors. Because it is believed that the lifespan of PH blocks and other high-rise buildings are dependent on a series of factors, regression techniques will be applied to model the relationship and determine the most significant mortality factors. Other than an empirical study of factors affecting the lifespan of buildings, the policy Delphi method will be used to explore options, rather than experts' decisions, for sustainable management of the ageing public housing stock. When what has been said is done, survival of Hong Kong's privately owned high-rise buildings, factors that result in their demolition, and policy options to manage the stock will then be studied. Seeing that the subject of ageing building stock is understudied in Asia, both private and public housing stocks in similar high-rise, high density Asian cities such as Singapore will be studied next using the aforementioned threefold approach.

6. ACKNOWLEDGEMENT

The work described in this paper was partially supported by a grant from the Research Grants Council of the Hong Kong Special Administrative Region, China (Project No. UGC/FDS25/E13/16).

7. REFERENCES

- Aksözen, M., Hassler, U., Rivallain, M. and Kohler, N. (2017). Mortality analysis of an urban building stock. *Building Research & Information*, **45**(3), 259-277.
- Anson, J. (2002). The life table: a sociological overview, in G. Wunsch, M. Mouchart and J. Duchene (eds.) *The Life Table: Modelling Survival and Death*, Kluwer Academic: Kluwer, pp 283-305.

- Bradley, P. E. and Kohler, N. (2007). Methodology for the survival analysis of urban building stocks. *“Building Research & Information”*, **35**(5), 529-542.
- Gallardo, C., Sandberg, N. H. and Brattebo, H. (2014). Dynamic-MFA examination of Chilean housing stock: long-term changes and earthquake damage. *“Building Research & Information”*, **42**(3), 343-358.
- Gleeson, M. E. (1981). Estimating housing mortality. *“Journal of the American Planning Association”*, **47**(2), 185-194.
- Gleeson, M. E. (1984). Application of a mortality model to subsidized housing. *“Environment and Planning A”*, **16**(7), 901-916.
- Gleeson, M. E. (1985). Estimating housing mortality from loss records. *“Environment and Planning A”*, **17**(5), 647-659.
- Gleeson, M. E. (1986). Estimating housing mortality with standard loss curve. *“Environment and Planning A”*, **18**(11), 1521-1530.
- HKHA (2016). Housing in figures, available at <https://www.housingauthority.gov.hk/en/common/pdf/about-us/publications-and-statistics/HIF.pdf>, retrieved on 24/5/2017.
- Huuka, S. and Lahdensivu, J. (2016). Statistical and geographical study on demolished buildings. *“Building Research & Information”*, **44**(1), 73-96.
- Johnstone, I. M. (1993). “The mortality of New Zealand housing stock”, Unpublished PhD Thesis, Department of Architecture, the University of Auckland.
- Johnstone, I. M. (1994). The mortality of New Zealand housing stock. *“Architectural Science Review”*, **37**(4), 181-188.
- Kleinbaum, D. G. and Klein, M. (2005). *Survival Analysis: A Self-learning Text*, Second Edition. Springer: New York.
- Komatsu, Y., Kato, Y. and Yashiro, T. (1994). Survey on the life of buildings in Japan, in *“Proceedings of Strategies and Technologies for Maintenance and Modernisation of Buildings”*, CIB W070 Tokyo Symposium, Volume 1, pp 111-118.
- Liu, G., Xu, K., Zhang, X. and Zhang, G. (2014). Factors influencing the service lifespan of buildings: an improved hedonic model. *“Habitat International”*, **43**, 274-282.
- Meikle, J. L. and Connaughton, J. N. (1994). How long should housing last? Some implications of the age and probable life of housing in England. *“Construction Management and Economics”*, **12**(4), 315-321.
- Muller, D. B. (2006). Stock dynamics for forecasting material flows – case study for housing in the Netherlands. *“Ecological Economics”*, **59**(1), 142-156.
- Riley, K. M. (1973). An estimate of the age distribution of the dwelling stock in Great Britain. *“Urban Studies”*, **10**(3), 373-379.
- Rincon, L., Perez, G. and Cabeza, L. F. (2013). Service life of the dwelling stock in Spain. *“The International Journal of Life Cycle Assessment”*, **18**(5), 919-925.
- Sartori, I., Bergsdal, H., Muller, D. B. and Brattebo, H. (2008). Towards modelling of construction, renovation and demolition activities: Norway’s dwelling stock, 1900-2100. *“Building Research & Information”*, **41**(11), 1223-1232.
- Theodoridou, I., Papadopoulos, A. M. and Hegger, M. (2011). Statistical analysis of the Greek residential building stock. *“Energy and Buildings”*, **43**(9), 2422-2428.
- Thomsen, A. and van der Flier, K. (2009). Replacement or renovation of dwellings: the relevance of a more sustainable approach. *“Building Research & Information”*, **37**(5/6), 649-659.
- Thomsen, A., Schultmann, F. and Kohler, N. (2011). Deconstruction, demolition and destruction. *“Building Research & Information”*, **39**(4), 327-332.
- Thomsen, A. and van der Flier, K. (2009). Understanding obsolescence: a conceptual model for buildings. *“Building Research & Information”*, **39**(4), 352-362.
- Yashiro, T. (2008). Overview of building stock management in Japan, in Y. Fujino and T. Noguchi (eds.) *Stock Management for Sustainable Urban Regeneration*, Springer: Tokyo, pp 15-32.

BUILDING MATERIAL PRICE DIFFERENTIATION IN SOUTH AFRICA: THE ROLE OF RETAILERS AND LOCATION

A. Windapo and A. Moghayedi

Department of Construction Economics and Management, University of Cape Town, South Africa

Email: Abimbola.windapo@uct.ac.za

Abstract: This study examines the price of building materials and investigates whether there are significant differences in the prices of building materials across South Africa and between retailers. The rationale stems from reports that there is a differential in building material prices across South Africa. However, it is not known whether the price difference between locations is statistically significant or whether there are differences in prices based on retailers of building materials. The study focuses on building materials as they are a primary resource used in construction and they contribute between 50 – 65% towards total construction costs. The research employs a quantitative research approach, based on a survey research design. The data gathered was analyzed using descriptive and inferential statistics including the ANOVA test. The research established that there was significant variation in building material prices across South Africa and between retailers. Based on these findings, it was concluded that it would be difficult for the government and private sector to have standard development plans for projects in South Africa and this will result in the poor performance of the construction industry in the long run and that construction methods and materials will also differ across the country. It is recommended that further studies be undertaken to determine what the factors are causing the significant price differentials across South Africa and to develop a model that can be used in accounting for location differentials in National project procurement.

Key words: Locational Price Variation, Material Prices, Price Differentiation, Retailers

1. INTRODUCTION

This research examines building material prices and whether there are significant differences in the prices of building materials across different geographic locations and retailers in South Africa. The rationale for this study stems from reports by cidb (2007), AECOM (2014) and Compass (2016) that there are differences in the prices of building materials across South Africa. Akanni (2006) and Udosen and Akanni (2010) describe building materials as resources which are put together when erecting or constructing a structure. Arayela (2005) elucidated that the significant contribution of building materials to cost poses a substantial threat to the construction industry especially the affordability of newly proposed projects. This risk is important when added to the potential for the price of building materials to vary across locations. While price is the amount of money that has to be paid to acquire a given product (Parkin, 2013), price differentiation is described by Ridley (2005) as a situation when different prices are charged to different consumers for the same product by different sellers within the same locations.

The construction industry has been the largest consumer of materials for almost a century with the building sector taking up two-fifths of the world's materials and energy flows while accounting for 40% of the total flow of raw materials worldwide each year (Horvath, 2004). According to Van Wyk (2003), the significant growth of the construction industry is highly dependent on the price stability of building materials. The increasing cost of building materials has proven to be a key challenge affecting the performance of the construction industry and projects even in South Africa (Windapo and Cattell, 2010). Thisse (2009) posits that the

differences in the prices of building materials, found to vary across different locations in most countries, pose a problem to the performance of the construction industry. This price differential makes it difficult for the government and the private sector to have standard development plans across the country. For example, in South Africa, the Reconstruction and Development Programme (RDP) houses cost ZAR 1800, ZAR 2070 and ZAR 1980 per sq. metre in Johannesburg, Cape Town and Durban respectively (AECOM, 2014).

Researchers show that the building materials constitute between 50-65% of total construction costs (Arayela, 2005; Oladipo and Oni, 2012; Windapo and Cattell, 2013; Akanni et al., 2014). The Construction Industry Development Board (cidb) of South Africa found that prices of certain building materials increase more rapidly than others, hence causing the prices of some materials to vary substantially from others throughout the country (cidb, 2007). Also, using Johannesburg as comparison city, Compass (2016) highlighted that building material prices in Cape Town, Pretoria and Port Elizabeth, and Durban are 1%, 2% and 2.5% lower than prices in Johannesburg, respectively, indicating that there is a building material price differential among the main cities in South Africa. This is further supported by a report by AECOM (2014) which posits that building costs vary across the provinces in South Africa. A valid conclusion based on these studies cannot be drawn at this point as there has been no evidence and in-depth analysis to verify whether there are significant differences between the prices of building materials based on location and retailers in South Africa. There has also been limited empirical research into the subject of building material price differentiation across geographic areas and between retailers in South Africa. Therefore, this will be a leading study to measure the phenomenon of building material price differentiation and benchmark/monitor building material price changes in years to come.

To do this, this paper, first of all, presents an overview of the nature and extent of the building material price variation across different geographic locations and the most common and price-volatile building materials in the South African construction industry. Secondly, the paper outlines the research methodology used in the study. After that, it presents the findings generated from descriptive and inferential analysis, and the interpretation of the results. After that, it delineates the conclusions and recommendations that are drawn from the study.

2. LITERATURE REVIEW

2.1 Overview of price differentiation and location theory

According to Ridley (2005), price differentiation is a situation when different prices are charged to different consumers for the same product by different sellers within the same locations. Price differentiation within geographic areas extends beyond building materials. Research carried out in New York City showed that food prices in supermarkets located in metropolitan areas were different from food prices in suburban and rural supermarkets (poor neighbourhoods) and that prices in the central city stores were 4.2% higher than prices in suburban stores, while prices in the countryside were 0.4% different from prices in suburban areas (Phillip et al., 1997). A high price differentiation among apples, carrots and toasters were presented by Michael et al. (2008) who carried out a study on 15 cities in U.S.A. He established that the prices varied more East-to-West than they did North-to-South due to distance and transport costs. Brandt and Holz (2006) also found that urban prices in China are systematically higher than rural prices for similar products.

Location theory as described by Beckman (1968) is the study of man's economic activity in the different geographical areas. It creates a spatial configuration in which prices and costs of items can be compared and justified. Location theory has evolved over time, starting with von Thünen in 1875, who concentrated purely on the cost approach and was reformulated by Weber in 1906 (Greenhut, 1960). Weber applies freight rate of resources and finished goods, along with the finished good's production function, to develop an algorithm that identifies the optimal location for manufacturing plant.

The price of building materials varies across locations in most countries. Research has shown that in India the prices of certain building materials including cement and paint differ across five of its cities, namely, Mumbai, Delhi, Chennai, Bengaluru, and Kolkata. For example, using Delhi as a comparison city, the price per cubic metre of cement in Mumbai, Chennai, Bengaluru and Kolkata is 10%, 17%, 26% and 22% higher respectively (Reddy and Jagadish, 2003; Rangroo, 2014). The prices of clear glass, plywood, wood and steel bars showed a similar trend. Research done in the Netherlands by Vrijhoef and Koskela (2000) showed similar price variability. In that study, the prices of cement, brick, and steel were found to be different across various locations and within the same areas in the country (Vrijhoef and Koskela, 2000).

Reports by Compass (2016) and AECOM (2014) on the South African construction industry, highlight the fact that there are differences in building material prices across South Africa. These reports by Compass (2016) and AECOM (2014) are aligned to Reid (2011) who opined that price variation could be found across different locations in South Africa. An examination of the Lafarge Gypsum SA price list 2013 reveals that there are differences in the price of cement sold by the manufacturer in South Africa. The price list shows that while Lafarge plasterboards in Gauteng are priced at R 76.70, the prices range from R 80.54 in Durban, Bloemfontein, and Polokwane to R 82.07 in Cape Town (LaFarge Gypsum, 2013). The prices of cement ceiling boards, suspended ceiling, and drywall partitioning showed a similar trend.

Price differentiation is attributed to different location factors namely transport cost, supply chain network, competition within an area, suitable labour, and labour cost, and income levels (Windapo and Cattell, 2014). This is because both manufacturers and suppliers need to include the cost of transportation in their selling price (ManuPrefab, 2013). According to Porter (1998) and Skitmore et al. (2006), the supply chain network and competition within a region, both contribute to the demand and supply of building materials within a location which puts pressure on prices of building materials in that area. Lalnunmawia (2010) citing Weber's location theory, acknowledges two primary causes related to the theory of location and regional factors as transport costs and labour.

2.2 Review of price differentiation within key building materials used in the study

This study focuses on only five building materials namely, cement, steel, timber, clay bricks and bitumen. According to Felix et al. (2014) and Horvath (2004) cement, sand, granite, reinforced bars, timber and structural steel are the most common construction materials used in civil engineering and construction projects. Also, these same materials have the most volatile prices in the construction industry (cidb, 2007; Laing et al., 2011; Windapo and Cattell, 2014). Table 1 shows the distribution of manufacturers of the selected building materials in South Africa by province.

From Table 1 it can be seen that some materials have more manufacturing plants than others for example clay bricks have the highest number of plants -127, cement has 21, timber 23, Steel 5, and bitumen has the lowest number 4. Table 1 also shows that some of the building materials have manufacturing plants in every province of South Africa for example clay bricks and cement while materials like steel and bitumen have manufacturing plants in only Gauteng, Western Cape, and KwaZulu-Natal provinces and this will have an effect on their price distributions across these locations.

Table 5: Distribution of the selected building materials by province and manufacturing plants

Building Materials	Provinces									Total
	Gauteng	Western Cape	Eastern Cape	Northern Cape	KwaZulu Natal	North West	Mpumalanga	Free state	Limpopo	
Cement	3	4	3	3	0	2	3	0	3	21
Clay	27	36	21	1	6	6	16	3	11	127
Steel	3	1	0	0	1	0	0	0	0	5
Timber	5	2	2	0	9	0	1	0	4	23
Bitumen	1	1	0	0	2	0	0	0	0	4
Total	39	44	26	4	18	8	20	3	18	180

Four leading suppliers control the South African cement market namely; Pretoria Portland Cement Company Limited (PPC) which controls 40% of the output and has the largest footprint and supplies in the inland market, Western Cape and Eastern Cape; AfriSam Proprietary Limited (initially known as Anglo Alpha Cement Ltd) which controls 31% of output and only supplies the inland market; Lafarge Industries South Africa Proprietary Limited, which controls 18% of production and only supplies the inland market and Natal Portland Cement (NPC) which controls 11% of output and only provides KwaZulu-Natal (Leach, 1994; Department of Minerals and Energy, 2005; cidb, 2007; Heyns, 2013). The lack of sufficient cement plants in most parts of South Africa, (see Table 1), is bound to lead to differentials in cement prices in these areas (KwaZulu-Natal and Free State) due to transportation costs and inconsistent supply. The cement industry also faces competition from cement and concrete substitutes such as clay bricks and structural steel hence contributing to the price variations across the locations (Leach, 1994).

The steel market is dominated by regional businesses such as ArcelorMittal, the largest and oldest reinforcing steel supplier and contractor in Southern Africa; Trident Steel, which is part of the Aveng Group; Reinforcing Steel Contractors, which is part of Murray and Roberts Steel and Capital Africa Steel which is a subsidiary of the WBHO Group (cidb, 2007). Since steel manufacturing plants are situated in three out of the nine provinces (see Table 1), high transport costs will be incurred to carry the steel from the manufacturing facility to the retailers and contractors in other regions. The prices of steel will not be the same countrywide due to the concentration of suppliers in particular provinces. Moreover, according to the South African Iron and Steel Institute (2013), the steel prices will be controlled by ArcelorMittal, the major steel supplier, and monopoly firm (if engaged in anti-competitive behaviour).

Timber is one of the common and oldest materials used for the construction of buildings worldwide with Pine (52%), Eucalyptus (39%) and Wattle trees (8%) being the predominant species in South Africa (Sunley, 1971; Kilman et al., 1994; Department of Agriculture, 2012). KwaZulu-Natal is the province with the highest timber manufacturing plants followed by Gauteng and Limpopo (see Table 1). The prices of timber in these regions will most likely be lower due to high supply as compared to the other provinces such as Mpumalanga, the Free State, North West and the Northern Cape, with fewer or no timber manufacturing plants, will incur high transport costs to convey timber from the suppliers to the job site and retailers, hence resulting in price variations of the timber countrywide.

There are 14 large brick companies in South Africa that have 60 factories across the country, and Corobrik is the biggest clay masonry manufacturer in the country and Africa producing about 3.5million products that range from clay bricks, concrete bricks, blocks and pavers (cidb, 2007; Corobrik, 2016). The majority of clay brick suppliers are located in the Western Cape, Gauteng, and Eastern Cape (see Table 1). The prices of clay bricks will most likely be lower in these provinces due to a higher supply of clay bricks and stiff competition as compared to provinces like Northern Cape, Free State and KwaZulu-Natal where the number of clay plants is relatively small. High transport costs will also be incurred to transport clay bricks to regions where the supply is low hence leading to the price variations in the price of clay bricks across South Africa.

The predominant constituents of Bitumen (a dark-brown cementitious material) either occur naturally or are obtained in petroleum processing. There are four main crude oil refineries in South Africa where bitumen is produced namely, Natref (operated by Sasol and Total) located in Gauteng Province, Calref (operated by Chevron) located in the Western Cape, Sapref (operated by BP SA and Shell SA) and Enref (operated by Engen) both located in KwaZulu-Natal near Durban (Willem, 2013). Due to the limited supply of oil refineries in South Africa (see Table 1), the transportation of bitumen to other parts of the country will be quite costly leading to price variations of bitumen across the provinces in South Africa.

3. ANALYTICAL FRAMEWORK

The theory of location acknowledges that transport costs and labour costs are determining factors in price differentiation. The literature review suggests that the manufacturing plants for steel and bitumen are not as widespread across locations in South Africa and it is probable that there will be a significant difference in the price of steel and bitumen across South Africa and between retailers. It can be deduced from the location theory and literature review that building materials will cost more in provinces with a fewer representation of manufacturers such as the Northern Cape, Free State, and North West because of transportation costs. Therefore, the study hypothesizes as follows:

H1: There is a significant difference in the prices of building materials across and within different locations in South Africa.

H2: There is a significant difference in the prices of building materials within retailers in South Africa.

4. RESEARCH METHODOLOGY

The study adopts a quantitative research approach and a cross-sectional survey research design. Primary data was collected using a questionnaire survey and telephone inquiries. The building material prices were sourced from three major cities namely; Johannesburg in Gauteng, Cape Town in Western Cape and Durban in KwaZulu-Natal. The three top cities were selected to minimize the inefficiencies that might have resulted from insufficient or incomplete data collected from each province and also because not all the major retailers had stores in all nine provinces countrywide.

The population of the study comprised of all the retailers across South Africa although the data analysed was limited to the information sourced from the five top retailers of building materials denoted by Retailer A, who are suppliers of building materials and other essential products that can be used for Do It Yourself (DIY) projects, home improvements and renovations, with 34 stores; Retailer B with 92 stores spread widely across South Africa targeting townships, rural and developing areas. Retailer C is one of the largest hardware stores with over 140 stores in Africa and is one of the leading building material store franchises in South Africa with a total of 122 retail stores; Retailer D has 268 stores and specialises in building materials and related hardware focusing its market on activities in the townships, rural and urban areas; and Retailer E with 72 stores that are focused on providing in-depth quality products at competitive prices to meet the needs of the local markets for home builders, contractors and other customers purchasing building materials (see Table 2).

The questionnaire was administered electronically via Survey Monkey® to all 334 representatives of the top five retail companies located in Cape Town, Durban, and Johannesburg. Since none of the recipients of the questionnaire responded to the survey, a telephonic survey was after that conducted to collect the relevant data from 35% (120) of the 334 retailers.

Table 6: Distribution of Retailers by Response Rate

	Retailers					Total
	A	B	C	D	E	
Number of surveys sent out	24	70	80	136	24	334
Telephonic responses obtained	11	16	17	16	15	75
Response rate	46%	23%	21%	12%	63%	22%

The retailers contacted were randomly selected from the list of 334 retailers such that every 4th retailer on the list was chosen and all retailers were given an equal chance of being selected. At the end of the telephone survey period from June-August 2016, a total of 75 positive responses were received as shown in Table 2. A response rate of 62.5% (75 out of 120 retailers) was obtained and an overall response rate of 22.46% (75 out of 334 retailers) with the highest response rate from Retailer E (see Table 2). The questionnaire was set up in a way that would help determine the prices of the five selected building materials, the possible factors affecting the price variation of building materials, the location of the manufacturers from whom the retailers procured these materials and the freight costs involved in transporting the materials from the manufacturer to the retailers' stores.

5. DATA PRESENTATION

The study sought to know the prices for the five selected building materials used in the study and the extent of their variation. The average prices for the five selected building materials - cement, steel, timber, clay bricks and bitumen obtained from the five selected retailers are presented in Table 3 and Figure 1. The average prices for the five selected building materials for Gauteng were used as a base price.

Table 7: Variation of building material prices in 2016 per province

Province	Cement per Tonne	Steel per Tonne	Timber per m ³	Clay Bricks per 1000 bricks	Bitumen per 1000 litres
KwaZulu-Natal	R 1,414.07	R 14,435.75	R 6,839.03	R 2,935.91	R 22,797.36
Variation in %	0.94%	6.77%	26.31%	87.74%	-22.21%
Gauteng	R 1,400.96	R 13,520.42	R 5,414.53	R 1,563.79	R 29,306.32
Variation in %	0%	0%	0%	0%	0%
Western Cape	R 1,989.26	R 16,954.21	R 5,545.19	R 3,730.16	R 16,828.52
Variation in %	41.99%	25.40%	2.41%	138.53%	-42.58%

It can be seen from Table 3 and Figure 1 that the prices in the Western Cape showed a greater price variation for the selected building materials compared to KwaZulu-Natal. The results further show a positive price change in cement at 41.99% and 0.94%, steel at 25.40% and 6.77%, timber at 2.41% and 26.31% and clay bricks at 138.53% and 87.74% between Gauteng, as the base Province, and Western Cape and KwaZulu-Natal respectively. It also reveals a high negative average price variation for bitumen at 42.58% between Gauteng and Western Cape and 22.21% between Gauteng and KwaZulu-Natal.

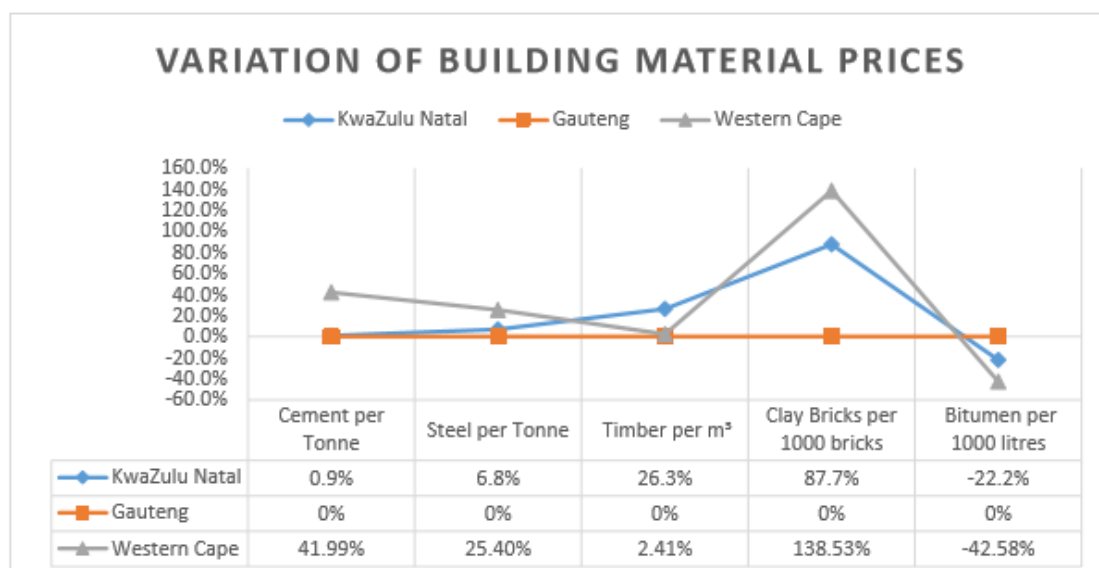

Figure 6: Variation of building material prices per province

5.1 ANOVA test for significant variation across provinces

The study hypothesized that there is a significant difference in the prices of building materials across different locations in South Africa. To test this hypothesis, a one-way ANOVA (Analysis of Variance) was conducted to determine whether there is a significant difference in the prices of building materials across the KwaZulu-Natal, Gauteng and Western Cape provinces of South Africa. The results of this test are presented in Table 4.

Table 8: Results of ANOVA test for differences in price between KwaZulu-Natal, Gauteng and Western Cape provinces

Building Material	Sum of Squares	Mean Square	F	Sig.
Cement per Tonne between provinces	5949158.094	2974579.047	53.182	0.00
Timber per m ³ between provinces	28790230.251	14395115.126	5.627	0.01
Steel per Tonne between provinces	160999591.051	80499795.525	14.698	0.00
Bitumen per Tonne between provinces	19404932389.135	970246644.567	3.051	0.05
Clay Bricks per 1000 bricks between provinces	62791004.741	31395502.371	23.227	0.00

Table 4 shows that there are significant differences in the prices of cement, steel, timber, bitumen and clay bricks at $p < 0.5$ level, across three different geographic locations in South Africa since their p-value is less than 0.05. Based on these findings, the null hypothesis is rejected, and the alternate hypothesis that there is a significant difference in the prices of building materials across different locations in South Africa is accepted.

5.2 ANOVA test for significant differences in building material prices within provinces

The study also sought to test the hypothesis that there are significant differences in building material prices within provinces. To test this hypothesis, a one-way ANOVA test was conducted to determine whether there are significant differences in building materials prices obtained from major retailers within KwaZulu-Natal, Gauteng, and Western Cape Provinces. It was found that there are statistically significant differences in bitumen prices between retailers in KwaZulu-Natal at the $p < 0.05$ level [$F = 499.74$, $p = 0.00$]; prices of steel [$F = 34.89$, $p = 0.00$] and clay brick [$F = 18.05$, $p = 0.00$] between retailers in Gauteng; and prices of cement [$F = 3.20$, $p = 0.03$] and timber [$F = 5.32$, $p = 0.00$] between retailers in the Western Cape of South Africa. Based on these findings, the alternate hypothesis that there is a significant difference in bitumen prices between retailers in KwaZulu-Natal, in steel and clay brick prices in Gauteng, and cement and timber prices in the Western Cape is accepted.

5.3 ANOVA test for significant differences in building material prices within retailers

Furthermore, the study hypothesized that there is a significant difference in prices within retailers, based on location. A one-way ANOVA was conducted to test whether there are significant differences in the prices of building materials within the five selected building material retailers A, B, C, D and E in South Africa based on location. The ANOVA tests reveal that there are statistically significant differences in the prices of:

- (i) steel [F =65.00, p=0.00], clay bricks [F =5.50, p=0.03] and bitumen [F =269.09, p=0.00] in Retailer A stores across the three provinces;
- (ii) cement [F =8.15, p=0.00], clay bricks [F =9.09, p=0.00] and bitumen [F =16.13, p=0.00] in Retailer B's stores across the three provinces;
- (iii) cement [F =57.36, p=0.00], steel [F =7.88, p=0.01], timber [F =11.85, p=0.00] and clay bricks [F =38.80, p=0.00] in Retailer C stores across the three provinces;
- (iv) cement [F =19.03, p=0.00], timber [F =7.71, p=0.01] and clay bricks [F =4.98, p=0.02] in Retailer D stores across the three provinces;
- (v) cement [F =14.59, p=0.00], steel [F =4.96, p=0.03] and clay bricks [F =10.54, p=0.00] and bitumen [F =14.14, p=0.00] in Retailer E stores across the three provinces.

Based on the results of the ANOVA tests, the alternate hypothesis that there are significant differences in the prices of clay bricks within all retailers; the prices of cement within four retailers (B, C, D and E); the price of steel within three retailers (A, C and E); the price of bitumen within three retailers (A, B and E); and the price of timber within two retailers (C and D), is accepted. Also, it can be deduced from the results presented in Tables 6-10, that clay bricks are the material with the most different price within retailers in South Africa, based on obvious significant differences in its price across all five major retailers. This is followed by cement, whose price is divergent amongst all retailers except retailer A.

6. DISCUSSION OF FINDINGS

The study found that there are significant differences in the average prices of the five essential building materials - cement, steel, timber, clay bricks and bitumen obtained from the five selected retailers in KwaZulu-Natal, Gauteng and Western Cape provinces of South Africa. This variation is aligned to the results of earlier studies by Vrijhoef and Koskela (2000); Reddy and Jagadish (2003); and Thisse (2009), who found that the prices of building materials vary across different geographic locations in a country. Western Cape was considered to have the highest average cement, steel and clay brick prices and the lowest average bitumen prices amongst the three provinces surveyed as shown in Table 3, while KwaZulu-Natal had the highest average timber price and Gauteng had the highest average bitumen price and the lowest average cement, steel, timber and clay brick prices.

The distribution of cement manufacturing plants across South Africa displayed in Table 1 illustrates that Gauteng has three cement plants, Western Cape has three plants and KwaZulu-Natal has no cement plants. Since there are no cement plants in KwaZulu-Natal, the average cement prices in KwaZulu-Natal was expected to be the highest among the provinces since the retailers would have to source the cement from other areas but the data gathered showed otherwise. The lower price of cement in KwaZulu-Natal shows that transport cost is not the cause of price differentials but other reasons such as Supply chain network or competition within the area (Windapo and Cattell, 2014). Gauteng province had the lowest average steel price amongst the three regions as shown in Table 3. This is probably because there are more steel suppliers in Gauteng province (ArcelorMittal and Scaw Metals than in the other two provinces that have only ArcelorMittal as the leading steel supplier (South African Iron and Steel Institute, 2013). The presence of many steel suppliers may result in lower steel prices due to the high competition among the vendors and the absence or shortage of steel suppliers in Western Cape and KwaZulu-Natal will lead to higher steel prices because the supplier will

monopolise the steel prices, which is aligned to findings of earlier studies by Windapo and Cattell (2014).

Also, the study found that KwaZulu-Natal had the highest average timber price compared to Western Cape and Gauteng. The average price of a cubic metre of timber in Western Cape was 2.41% greater than Gauteng while the mean price of a cubic metre of timber in KwaZulu-Natal was 26.31 % higher than in Gauteng. The distribution of timber sawmills across South Africa displayed in Table 1 illustrates that Gauteng, Western Cape, and KwaZulu-Natal had 5, 2 and 9 timber mills respectively. KwaZulu-Natal had the highest number of sawmills and paradoxically they had the highest average price as well. Table 3 shows that the clay brick prices were highest in Western Cape and lowest in Gauteng. The average price of clay bricks in Western Cape was 138.53% greater than Gauteng while the mean price of clay bricks in KwaZulu-Natal is 87.74 % higher than Gauteng hence showing the extent of the price variation. Although Western Cape had the highest number of clay brick suppliers in South Africa (36 suppliers), as shown in Table 1, clay brick prices were highest in the Western Cape, while clay brick prices were lowest in Gauteng. This is aligned to findings by Porter (1998) and Skitmore et al. (2006).

Higher bitumen prices are recorded in Gauteng compared to the Western Cape or KwaZulu-Natal respectively. In South Africa, Natrel is the only bitumen supplier in Gauteng, while Chevron is the only bitumen supplier in the Western Cape (Muller, 2009). KwaZulu-Natal, on the other hand, has two suppliers namely Enret and Sapret. The price differentiation may, therefore, be as a result of a combination of monopolies in Gauteng provinces, and the fact that Gauteng is an inland province and does not have a seaport. The ANOVA test conducted further confirmed that there is a significant difference in building material prices across the different provinces examined in South Africa. This finding is aligned to that of earlier studies by Windapo and Cattell (2014) and Felix et al. (2014) that prices of building materials vary across geographic locations.

In general, these findings suggest that retail prices of building materials within provinces up to 500Km from manufacturers do not differ as a result of distance, however, location is a key element in building material price differentiation in South Africa, because the prices do not only vary by location but also differ within the same retailer based on location. This study extends the location theory to the retail space. The findings imply that if there are great price differences, there will be different materials and construction methods used in the different cities as developers and contractors respond to different prices in different locations.

7. CONCLUSIONS

This study examines the prices of selected building materials in South Africa and examines whether there are significant differences in the prices of building materials across South Africa and within retailers. It was found that the prices of building materials differ significantly within South Africa, and between locations. It was also discovered that the significant differences in prices were lower within locations based on retailers when compared to differences within retailers based on location. Based on these findings, it can be concluded that location and not the distance of the retailer is a key factor in the price variation of building materials across South Africa.

This difference in building material prices implies that there will be different materials and construction methods used across South Africa as developers and contractors respond to different prices in different locations. This will create variety as contractors try to respond to prices of building materials in different locations. The significant price differentiation also indicates the appropriate building materials to be preferred in different locations.

The study recommends that the South African government and the construction sector stakeholders have to pay particular attention to the location factors (monopoly, competition, supply and demand, income levels and transport) that have a major effect on the prices of building materials and that when designing pricing policies, construction industry stakeholders should consider the nature of price differentiation in South Africa, and pay more attention and strictly regulate prices, the monopolies of building material manufacturers and retailers across South Africa, and come up with policies and procedures to counteract this monopoly such as the use of different construction methods and more appropriate materials. It is recommended that further studies be undertaken to determine the causes of significant differences between building material prices across South Africa and into the development of a model that can be used in accounting for location differentials in National project procurement. It will also be good to repeat this exercise in three to five years to know how changeable are prices over time and location.

8. ACKNOWLEDGMENTS

The authors would like to acknowledge, with thanks, the assistance of the following people in conducting the survey: Monica Tumuhairwe and Vogel Kayombo.

9. REFERENCES

- AECOM, T.C. (2014) Property and Construction Handbook International. In, London.
- Africa, R.o.S. (2016) Forestry [Online]. Available: <http://www.gov.za/about-sa/forestry> [Accessed 5th July 2016, 2016].
- Aitcin, P. (2008) Binders for durable and sustainable concrete London: Taylor and Francis
- Akanni, P. (2006) Small-scale building material production in the context of the informal economy. The Professional Builders, 13-18.
- Akanni, P., Oke, A. and Omotilewa, O. (2014) Implications of Rising Cost of Building Materials in Lagos State Nigeria. SAGE Open, 4(4), 2158244014561213.
- Arayela, O. (2005) Laterite Bricks: Before, Now and Hereafter.
- Beckman, M. (1968) Location Theory. New York: Random House.
- Brandt, L., and Holz, C.A. (2006) Spatial price differences in China: Estimates and implications. Economic development and cultural change, 55(1), 43-86.
- cidb (2007) The Building and Construction Materials Sector, Challenges and Opportunities, 11-25.
- Compass (2016) Global Construction Cost Yearbook. 16th Annual Edition ed. Morrisville, Pennsylvania, USA: Compass International Consultants Inc.
- Corobrik (2016) Corobrik Company Profile [Online]. Available: <http://www.corobrik.co.za/company-profile> [Accessed 29th May 2016].
- Department of Agriculture, F.a.F. (2011/2012) Report on Commercial timber resources and primary roundwood processing in South Africa. Pretoria, South Africa: Forstry Economics Services CC.
- Department of Agriculture, F.a.F. (2012) A Profile of the South African Forestry and Wood Products Market Value Chain. South Africa.
- Energy, D.o.M.a. (2005) Dolomite and Limestone in South Africa: Supply and Demand. Pretoria, South Africa: Retrieved from http://s3.amazonaws.com/zanran_storage/www.dme.gov.za/ContentPages/18713922.pdf.
- Ertug, G., A and Jacob, P., Kovel (2000) Using GIS in Emergency Management Operations. Journal of Urban Planning and Development, 126(No.3), 136-149.

- ESRI (2014) What is GIS? [Online]. Available: <http://www.esri.com/what-is-gis> [Accessed 10/04/2016, 2016].
- Felix, O., A, Moses, O., A and Sodiq, B., O (2014) Comparative Study of Price Variations of Basic Civil Engineering Construction Materials. *Energy and Environment Research*, 4(No. 3), 50-57.
- Greenhut, M. (1960) Size of Market versus Transport, *The Journal of Industrial Economics*, 172-184.
- Heyns, R. (2013) Cement in South Africa. *Kagiso Asset Management Research*, 8-12.
- Horvath, A. (2004) *Construction Materials and the Environment*, 181-200.
- Kilman, W., Tom, S. and Hong, L.T. (1994) *Restoring and Reconstructing the Malay Timber House*. Kuala Lumpur: Forest Research Institute Malaysia.
- Lalnunmawia, H. (2010) Weber's Theory of Industrial Location. [Online]. Available: Tromana college: <http://www.trcollege.net/study-materials/102-webers-theory-of-industrial-location> [Accessed 28th August 2011].
- LaFarge Gypsum, S. (2013) Price List 2013 [Online]. Johannesburg. Available: http://www.lafarge.co.za/Lafarge_Feb_2013_Price_List.pdf.
- Laing, P., Marcus, G. and Dhansay, A. (2011) Factors Determining the Volatility of Building Material Prices in the Construction Industry. Department of Construction Economics and Management, University of Cape Town.
- Leach, D.F. (1994) The South African Cement Cartel: A Critique of Fourie and Smith, 156-168.
- ManuPrefab (2013) Main Factors that influence the total construction cost in Costa Rica [Online]. Available: <http://manuprefab.com/main-factors-influence-total-construction-cost-costa-rica> [Accessed 15th March 2016].
- Michael, A.A., Kurt, C.S. and Stephen, L.S. (2008) A Spatial Model of National and International Price Dispersion: Theoretical and Empirical Findings.
- Oladipo, F., and Oni, O. (2012) Review of Selected Macroeconomic Factors Impacting Building Material Prices in Developing Countries—A Case Of Nigeria. *Ethiopian Journal of Environmental Studies and Management*, 5(2), 131–137.
- Parkin, M. (2013) *Global and Southern African Perspectives*. 2nd ed. South Africa: Pearson Education
- Phillip, R.K., James, M.M., Steve, M.L. and David, M.S. (1997) Do the Poor Pay More for Food? Item Selection and Price Differences Affect Low-Income Household Food Costs. Washington, DC:
- Porter, M.E. (1998) Location, Clusters, and the New Microeconomics of Competition. *Business Economics*, 76,76,77-90.
- Rangroo, S. (2014) Building Materials Price [Online]. Available: <http://constructionworld.in/buildingmaterialprices/building-material-prices-october14.pdf> [Accessed 16th May 2016].
- Reddy, B.V., and Jagadish, K. (2003) Embodied energy of common and alternative building materials and technologies. *Energy and Buildings*, 35(2), 129-137.
- Reid, I. (2011) Construction material price variations. In: R.Edward, Ed.
- Ridley, D.B. (2005) Price differentiation and transparency in the global pharmaceutical marketplace. *Pharmacoeconomics*, 23(7), 651-658.
- Sector, F.M.F.P.a.M. (2014) A profile of the forestry and wood products sub-sector. In: *Forestry and Wood products sector*, 12.
- Skitmore, M., Runeson, G. and Chang, X. (2006) Construction price formation: full-cost pricing or neoclassical microeconomic theory? *Construction Management and Economics*, 24(7), 773-783.
- South African Iron and Steel Institute, S. (2013) Iron and crude steel production in South Africa [Online]. Available: <http://www.saisi.co.za/index.php/steel-stats/iron-and-crude-steel-production> [Accessed 28th June 2016].
- Sunley, J., G (1971) The future of timber in the building industry. *The Commonwealth Forestry Review*, 50(No.3), 247-253.
- Thisse, J.F. (2009) *How transport costs shape the spatial pattern of economic activity*. OECD Publishing.
- Udosen, J., and Akanni, P. (2010) A factorial analysis of building material wastage associated with construction projects. *Journal of Civil and Environmental Systems Engineering*, 11(2), 81-90.
- Van Wyk, L. (2003) A review of the South African construction industry. Part 1: Economic, regulatory and public sector capacity influences on the construction industry. *Boutek, CSIR (Council for Scientific and Industrial Research)*, Pretoria.
- Vrijhoef, R., and Koskela, L. (2000) The four roles of supply chain management in construction. *European Journal of Purchasing & Supply Management*, 6(3), 169-178.
- Willem, B.H. (2013) Determining illegal cartel overcharges for markets with a legal cartel history: bitumen prices in South Africa, 39.
- Windapo, A.O., and Cattell, K. (2010) Perceptions of key construction and development challenges facing the construction industry in South Africa. In *Proceedings*, July 2010, Durban, South Africa.
- Windapo, A.O., and Cattell, K. (2013) *The South African Construction Industry: Perceptions of Key Challenges*

Facing Its Performance, Development, and Growth. *Journal of Construction in Developing Countries*, 18(2), 65.

Windapo, A.O., and Cattell, K. (2014) Evaluation of Location Factors Influencing Building Material Price Variation in South Africa. In, ICEC 2014 Conference, 20-22 October, Milan.

W89: EDUCATION IN THE BUILT ENVIRONMENT

DEVELOPING THE SOCIAL ASPECTS OF SUSTAINABLE FACILITIES MANAGEMENT –A MULTI-COUNTRY SUMMER SCHOOL PROJECT

M. Buser¹ and M. Støre-Valen²

¹ *Construction Management, ACE, Chalmers, Gothenburg 412 96, Sweden*

² *Department of Civil and Environmental Engineering, NTNU, Trondheim 7491, Norway*

Email: buser@chalmers.se

Abstract: The introduction of sustainability asks for complex solutions and requires multidisciplinary competences that Facilities Management educations have to integrate. Whereas research has demonstrated that FM can play a central role in implementing sustainable solutions, it appears that practitioners don't have sufficient access to knowledge and tools to develop their practice efficiently. In particular, methods to integrate all the stakeholders and above all the users, indispensable to the success of these initiatives, seem missing. This paper presents the assessment of a summer school aiming at providing 35 students from three Scandinavian countries with a holistic understanding of sustainability including the users' perspective. We discuss the pedagogical challenges related to this kind of event as well as their potential contributions to develop tools of relevance for both educational and professional purposes. The summer school concept is building on Project-Based Learning. The supporting staff includes academic teachers, researchers and practitioners. The challenge is to create a pedagogical platform merging both academic and professional interests, methods and criteria for success. The material for this qualitative study are gathered through participant observations formal progress and assessment sessions. The summer school took place in March 2017 in Trondheim Norway, here we present our preliminary results

Keywords: Education, Facilities Management, Pedagogical Tools, Project Based Learning, Sustainability, Users

1. INTRODUCTION

The potential of Facilities Management (FM) in implementing sustainable solutions and reducing energy consumption has been widely recognized as operation and maintenance of buildings require a large amount of energy and material. Their contribution on social aspects of sustainability has also been underpinned (Elmualim et al. 2010). Whereas there is a general consensus on the necessity to engage in sustainability, the concept itself is subject too many definitions encompassing different dimensions and applications strategies (Sarpin et al 2016). Whereas standards and certifications constitute a working frame and define environmental and often measurable targets, they don't perform as well to address the challenges of social sustainability especially as its social dimensions may contain internal tensions and contradiction (Buser and Koch, 2014) Integrating the multiple users' needs and behaviours is therefore a challenge for the industry (Sarpin et al 2016). Most scholars agree that the combination of environmental, economic and social objectives requires multidisciplinary competences. Besides, they also have demonstrated that in order to achieve sustainability targets, FM practitioners need to overcome organizational and cultural barriers and develop new competences and knowledge (Elmualim et al., 2009, Sarpin et al. 2016). Sustainability concerns have created new demands regarding the collaboration between facilities management providers and their customers. Where previously service delivery could be described as a "one-way" distribution, the realization of sustainable goals to be successful demands the active participation of the users to be achieved. However, integrating the users is

quicker said than done, and FM managers in various sectors are struggling to find innovative solutions and motivate their users to participate in their implementation of sustainability.

We present here a summer school, proposed to bachelors and master students in construction engineering and facilities management, and aiming at creating awareness around the lack of users' attention and participation. Our goal is to assess the summer school in term of pedagogical and professional relevance as well as to discuss its potential to be translated into generic teaching material.

2. TEACHING SUSTAINABILITY

There is an increasing interest in construction sector to employ sustainability trained graduates. To answer this demand, many universities are now offering sustainability related education; however, most of them either address environmental and engineering topics or build on normative managerial approach (Lozano et al. 2015). Still, in order to integrate fully the social dimension of sustainability, the students should learn to take into account and engage stakeholders to participate to the process. This can only be done through collaborative activities across disciplinary and professional boundaries. However, this engagement by universities with societal stakeholders in teaching and learning for transformation towards sustainability, remains a challenge (Trencher et al. 2015). Wilson and Pretorius (2017) underline the learning potential in practitioners' engagement in education programme which both enhances student engagement with sustainability issues and allows the co-creation of knowledge addressing both the academic and practitioners' interests. To draw attention and to document the users related issues encountered by facilities managers, our project integrates the participation of practitioners and the use of real life situation (Mauser et al. 2013). In order to integrate these FM practitioners' experiences and contexts, the summer school builds on the stream of Project-Based Learning (PBL). PBL is a comprehensive approach to classroom teaching and learning designed to engage students in investigating authentic problems (Blumenfeld et al., 1991). It aims at students acquiring a deeper knowledge through active exploration of real-world challenges and problems. Characteristics of PBL include the following: the students must take the responsibility for their own learning; the problem delivered to the students' needs to be "ill-structured" and allows them the possibility of free enquiry; learning should be integrated from different disciplines and topics; collaboration is essential; a closing discussion and assessment of self-learning is essential at the end of the exercises (Savery, 2015). The summer school builds on four ongoing FM projects dealing with challenging sustainable developments in Denmark, Norway and Sweden.

2.1 The context of the summer school

The creation of this summer school is financed by Nordic built. Nordic Built is a Nordic initiative aiming at accelerating the development of sustainable building concepts, initiated by the Nordic Ministers for Trade and Industry. Its purpose is to bring together companies, public administrations and researchers within the Scandinavian countries for collaboration and the realisation of concrete projects. Accordingly, the goal of the summer school is to develop new teaching material supporting a Scandinavian model of FM incorporating sustainability.

As sustainability concerns are shared globally by many members of the facilities management industry, it can be uneasy to identify a pure Scandinavian model of FM. The purpose of the present paper is not to discuss whereas these qualities are uniquely Scandinavian or if they are

put into practices by practitioners. Rather, we focus on the constitutive elements of these criteria which also appear in the chart of Nordic Built, who finances the summer school we discuss here.

Whereas, FM can take different forms depending on the organization and target countries (Tuomela and Puhto, 2001), and that every Scandinavian country has at least several peculiarities emerging from the local laws and traditions (Maliene et al 2008), there are still some common denominators in what can be called Scandinavian FM. In particular, the focus on user-based management that can contain all the facility services and tasks from the strategic to the operational level can be seen as a specific feature (Maliene et al 2008). Elle et al. (2004) have defined this Scandinavian FM as opposed to a “traditional way”, mainly USA and UK, as: including all the phases of the building process following a life cycle model; as encompassing not on the interest of a single organisation but the interests of society in specific area; as focussing on sustainability, participation and holistic principles in top of stakeholders’ management and economical perspective. These criteria are constitutive of the summer school basic assumptions, whereas not all case studies have integrated these criteria, they all appear punctually in one or the other.

2.2 The summer school concept

The summer school is a single event which took place at NTNU in Trondheim Norway in March 2017. The educational institutions’ (NTNU, Chalmers, KEA and VIA) goal is to develop educational materials and a learning method that can be applied in the Nordic countries. Working with problem based pedagogic and real case projects, the students develop new and innovative solutions through access to expertise from research and practice. Scandinavian attribute can also be found in the choice of languages for the summer school, most of the documentations and exchanges are expressed in either Danish, Norwegian or Swedish; English is only used to few common sessions.

Forty students from three Scandinavian countries were invited for a week to deepen their understanding of sustainability in relation to FM. The students are presented with “real” situations: a project in a concrete context with its stakeholders, limitations, challenges and possible contradictions. By integrating “real world” cases, we expect to enhance students’ motivation and engagement in working with sustainable issues but also to confront them with the existing conditions and practices of professionals active in this development. The students are engaged to reflect, discuss and work in groups to develop innovative solutions to “real-life” sustainability challenges.

According to Lozano (2014), one key element to design and build the content of such course, is learning outcomes, which need to include the demonstrable acquisition of specific knowledge and skills and reflect the institution’s objectives and graduate attributes. Once the learning outcomes have been agreed upon, the strategies for teaching and assessing these outcomes must be chosen accordingly. In our case, the learning outcomes have been developed to answer the challenges identified in the literature, the ones pinpointed during a workshop gathering more than forty professional both practitioners and academics working with sustainability and facilities management. These have been matched with the deficiencies that the four teachers leading the project have identified in their own education. The learning outcomes are the following:

- The students should be able to develop sustainable FM projects from strategic level to implementation
- Identify and evaluate positions, needs, concerns and dilemmas of the diverse organizations and actors engaged
- Identify, select, implement and assess solutions including both technical, economic, environmental and social aspects
- Understand the complexity of projects that has a goal to develop sustainable operations of buildings in practice

2.3 The project teams

The project partners include two professional schools in Denmark: KEA in Copenhagen and VIA in Horsens; two universities Chalmers University of Technology in Gothenburg Sweden and the Norwegian University of Science and Technology in Trondheim Norway. The project has been initiated and is managed by the Danish Association of Building Experts, Managers and Surveyors, Konstruktørforeningen (KF).

Chalmers, Göteborg Sweden, and NTNU Trondheim Norway

Chalmers University of Technology and the Norwegian University of Science and Technology (NTNU) are offering bachelor, master and PhD education in engineering. The selected audience for the Summer school is the Master students studying Design and Construction Project Management (Organisering och Ledning i Bygg och Fastighetssektorn). The students are trained in the skills needed to manage construction projects involving project management methods, financial accounting methods, BIM, logistics, environmental management, strategic management, facility management and sustainability. To prepare the students to demands of the construction industry, where projects are done in temporary and interdisciplinary project organizations supported by networks of colleagues, training and knowledge are provided on organizational culture, leadership, communication, group- and team work, decision making, collaborative relations, and knowledge and learning. Whereas the students at NTNU can graduate in both construction and facilities management, this is not possible at Chalmers where they can make their master thesis within sustainability FM topics in relation to companies but not graduate in FM or sustainability. Whereas students are informed and trained in management topics, they lack more concrete confrontations to the practical aspects of what leading FM sustainable project implies, such as the contact and management of the different stakeholders and in particular the users.

KEA Copenhagen and VIA Horsens, Denmark

Copenhagen School of Design and Technology (KEA) is an Academy of Higher Education which offers over 30 different educational programmes at Bachelor degree and Academy Professional degree levels. The students targeted by the spring school are the constructing architects, enrolled in “professional” bachelor. Constructing Architects are primarily engaged in design of building and infrastructure, but they are also employed in other companies related to the construction industry, eg in state and municipal, residential and management companies, banks and credit unions, and technological institutes. Their education is technically oriented and they do not develop a holistic approach to sustainability, they may need further training and develop competences in communication, finance, planning, communication, users’ behaviours and participation, technology understanding, organization, process understanding, law, and empathic understanding.

VIA university College Horsens is a young institution, similar to KEA but situated in Jylland. VIA offers professional bachelors. The target students are here as well the construction architect. VIA however is working closely with practitioners to run their educations

The choice of different types of educations related to facilities management is done to mirror the setting of professional practices where different educational backgrounds meet in enterprises and in projects. The participation of the different Nordic countries builds on both the similarities between the participants, the Scandinavian models usually refers to flat hierarchy, well organized labour, social values (Sandberg et al. 2013) summarised in the chart of Nordic Built; and the particularities of each of the nations in term of culture, educational models and philosophy.

Each institution is represented in the project team by one teacher/researcher, but several participants for each institution have participated in the different activities of the project. The team gathered multi-disciplinary competences (architects, engineers, sociologist). Besides, FM practitioners, representing the client in our four cases, are joining the summer school to contribute with knowledge of the specific project, concrete experiences of collaborating with stakeholders and competences in working with FM. They have two concrete tasks, the first is to answer students' questions relative to the project, the second to assess the quality and feasibility of the students results at the end of the summer school. The group of practitioners includes two social housing companies, a contractor and a facilities management company.

2.4. Teaching concepts

Building on the PBL philosophy of teaching, the summer school focuses mostly on students' project work introduced by a few academic lectures and case presentations from professionals working with sustainability. Merging both the learning from academic research and professional expertise, the goals of the presentations is to draw the attention of these engineer students away from focusing only on the design of technical solutions towards more social aspects such as the roles and the competences of stakeholders and the needs and behaviours of the users.

The cases build on written descriptions of the companies' profiles: size, portfolio, competences, location and the characteristics of the specific project: buildings physics and conditions, actual issues, profile and types of users, budget. These written documents are completed by technical drawings, and pictures video of some of the stakeholders involved in the project (janitors, inhabitants, technic providers). The cases are presented in plenum and the students are introduced to different challenges, they then are distributed in small workshops where two groups of four students work separately on the same case. Each case is attributed a supervisor who provides support to the students' process. Contact with the professionals working with the case are organised so that the students are able to seek information or test the feasibility of their ideas. During the three days of the spring school, the groups work mostly independently. However daily meetings with other students allow a reflection not only on the designed solution but also the methods the groups have chosen and the process they follow as well as their eventual interrogations and doubts in carrying the project.

Most of the cases includes technological improvements for the building. However, the focus is on designing solutions adapted to the specific users and easy to maintain. The results of the groups are presented to the practitioners working with the specific case and the referent teacher.

3. METHODS

The framework of understanding builds on an interpretive sociological approach appreciating a strong empirical orientation and uses a mix methods approach (Bryman and Bell, 2007). The paper draws on different assessment carried during the summer school as well as a day debriefing including 5 members of the project team two weeks after the summer school. A questionnaire with 25 questions distributed to all students at the end of the week gives a quantitative description of the participants' evaluation of school, the answers rate is 34/35. The qualitative part of the evaluation comprises: two qualitative individual assessments carried the first and the second day of the group work where all students were asked to give their impression focusing on their own process and their team progress; two common sessions joining teachers and students at the end of the first and the last day to assess and discuss the process and progress of the different groups as well as the setting of the school. Process book of each of the 8 groups documenting the steps the students have taken to solve their tasks. Observation of group works done by the seven teachers participating and the diary 5 of them kept during the summer school. Last, the participation of the practitioners has been observed during the 1 to 2 hour questions sessions between the students and the companies' representatives, the students' presentation to the companies and finally a short informal assessment with the practitioners after the session. The different feedbacks were discussed by the project members during the debriefing. We present here the first assessment of the results.

4. SUMMER SCHOOL ASSESSMENT

In the following we present briefly the tasks, the students, the teachers and practitioners assessment of the summer school.'

4.1 The tasks

Building on the PBL philosophy of teaching, the summer school focus mostly on students' project work introduced by a few presentations from professionals working with sustainability. Merging both the learning from academic research and professional expertise, the goals of the presentations is to draw the attention of these engineer students away from focusing only on the design of technical solutions towards more social aspects such as the roles and the competences of stakeholders and the needs and behaviours of the users.

The student work is based upon on the base of four ongoing projects aiming at bridging the three aspects of sustainability and taking place in the Scandinavian countries:

1. A Norwegian project, case 1, dealing with the luxury renovation of an Hotel built in 1870;
2. A Swedish project, case 2, aiming at engaging the users of a retrofitted university building to act and use the building according to the new specification
3. A Danish project, case 3, a social housing retrofit focusing on inner climate and on engaging the residents to act accordingly to new standards
4. A second Danish project, case 4, a new built eco housing area which goal is to motivate the residents to take responsibility, operate and maintain the buildings and surrounding

The cases describe the companies' profiles: size, portfolio, competences, location and the characteristics of the specific project: buildings physics and conditions, actual issues, profile and types of users, budget. These written documents are completed by technical drawings,

pictures. The case problems are presented by the teacher to the two groups of four students working separately on the same case. Each case is attributed a supervisor who provides support to the students' process. Contact with the professionals working with the case are organised so that the students are able to ask further information or test the feasibility of their ideas. During the three days of the spring school, the groups are working mostly independently. However, daily meetings including all the participants to enable a reflection not only on the designed solution but also the methods the groups have chosen and the process they follow as well as their eventual interrogations and doubts in carrying the project.

Most of the cases include technological improvements of the building. However, the focus is on designing solutions adapted to the specific users and easy to maintain. The results of the groups were presented to the practitioners related to the case the last day of the summer school.

The table below (table 1) is indicative and summarises shortly the cases features and related solutions proposed by the students.

Table 1: Summary of the cases

Case	1 Hotel, Norway	2 University, Sweden	3 Social housing, Denmark	4 Eco housing, Denmark
Context	Large ambitious renovation of a hotel built in 1870	Retrofit of a university building, the creation of small open offices and new meeting area	Designing retrofit for social housing targeting inner climate issues	New built of sustainable housing, users participation in operation and maintenance
Goal	How to integrate sustainable solutions including the hotel's guests	How to engage users (students and employees) to behave according to the sustainable goals integrated in the building	To solve inner climate issues and engage the residents to act accordingly to new standards	To motivate the residents' association to take responsibility, operate and maintain the buildings and surrounding
Client	Contractors	Facilities management company	Public housing company	Public housing company
Challenges	To create a luxury hotel which builds on sustainable principles and engage clients to behave accordingly	To create an attractive environment that inspires and supports the interaction between researchers, students and companies.	To engage and motivate residents to take an active role	To motivate the residents to do self-management and operation of housing and common areas
Students contribution	App technology: Smart intelligent rooms Adapt prices to sustainability contributions sustainability: demonstrate how guests can contribute to save energy by choices of different prices in the booking	Apps and smart technology for the FM unit: Monitoring use of space Room booking BIM for all buildings Information Operational planning Training program Motivation/points User: Social zone with a green garden with fresh vegetables Gaming café	Formation and monitoring tool that affects the behaviour of the residents: Inspiring information What is expected when living here Social events Surveys Professionals to handle technical installations	Organize tasks and inform the residents in what task they are expected to engage in Information channel Clear Incitement's for doing the tasks and consequences for when the maintenance tasks Yearly maintenance day for fellowship and common good

4.2 The students' assessment

The number of seats for students of each institution was limited to 10, forcing teachers to prepare a selection process to choose the participants. However, the challenge of choosing was spared to the teachers as only a limited number of students applied to join even if their participation was free of charge. Only five Norwegians, who did not share the prospect of

travelling to another university or country took finally part to the Summer school. It seems that, though students were interested in the topic, it is difficult for many to extract themselves from their daily routines for a whole week.

However, for the ones who joined, the summer school was a success and they unanimously praise their experiences. Looking at the students' assessment, our four learning outcomes seem to have been achieved in a large majority. The results of the questionnaires (table 2) shows that most of the students feel they have increased their understanding of the social aspects of sustainable FM implementations. The pedagogic setting has also been celebrated by the audience. *I have really appreciated to have the freedom of choosing on what and how we would work together, that was really cool (Danish female student).*

Table 2. Results of the students' questionnaire

Questions	Scale	Very good	Good	Fair	Bad	Total
What is your assessment of the SuS		19	15	0	0	34
Does the SuS contributing to your education		15	15	4	0	34
Do you have a better understanding of the social aspects of sustainability challenges after the SuS		10	19	4	1	34
How do you assess the participation of the professionals to the setting		14	12	6	1	33
Do you feel you participate constructively to the group work		19	15	0	0	34
As the SuS improve your understanding of the two other national cultures		22	11	0	1	
Would you recommend the SuS to other students		26	3	1	0	30

The possibility to work on “real” cases and interact with practitioners has clearly being a very important motivation factor. The only frustration expressed by a few students is related to the quality of the interaction with a few companies' participants (table 2). As some of the Danish practitioners could not be present in Trondheim, the discussion had to take place over skype. This situation was perceived as very challenging by the non-Danish speaking students.

The use of a mixture of Scandinavian languages though creating doubt and frustration at the beginning of the process has proved to be a well mastered challenge which has unexpectedly contributed to the knowledge sharing process. As expressed by one of the Swedish student: *it is incredibly frustrating not to be able to take over the project and to control it as I would usually do at home. Here, I have to be sure that we can understand each other and understand the task. We take a lot of time to explain to each other how we interpret the case. But this great because I learnt of lot about myself and about the others... what we have explained to each other we do share. We never take the time home to check if we have the same understanding of what need to be done, we take it for granted (Swedish female 24).*

A common observation to the teachers was the unexpected degree of attention of the students for each other in, for example, the care taken is assuring the integration and contribution of all the members of the groups. According to the answers to the questionnaire (table 2), the goal of creating bridge between the participating countries is achieved. This is also underlined by the two following quotations. *This was a wall breaker I have learnt more about Danish people during this week that I will during the rest of my life. I made real friends here (Swedish male student). This experience has given me envy to go and work in other of the Scandinavian*

countries, I would never have thought of it before (Danish male student). However, the observation tends to show that when participating to social activities outside of the project, the grouping tended to respect the national boundary.

4.3 The teachers

Engaged in both the organisation and the evaluation of the summer school, the seven teachers were kept fully occupied during the whole week. Though, the cases and the supervision of the groups were formatted to offer similar conditions to all the groups, a certain interpretative flexibility was exercised in dealing with the students' supervisions. Some teachers would stay with the students and facilitate their process others would only pop in in their room from time to time. The orientation of the cases was also dealt with differently, a very clear and narrow issue in case 3 and very open and broad topics in case 2. However, these differences were perceived as an advantage as they illustrated the diversity of situations and practices and therefore participated to the learning process of the school. The students have too expressed diversity in assessing the teachers' contributions. However, the main critic to the teacher performance is directed to the lack of alignment between the teacher and the practitioners regarding the interpretation of challenges of one case and not the style of supervision.

The variety of teachers' experience, understanding and professional background also appear in the assessment of the summer school: for some the cases material represents the added value of the week, for other it is the pedagogical setting which is the validated outcome. This diversity of interpretations could be an issue when the project team will have to agree and provide a common material for sustainable FM which is the main outcomes of the Nordic built project. It also reflects and underlines the complexity of having multi-disciplinary team working together as the participants tend to prioritise their own field and teaching practices. Similarly, the lack of criteria precise enough to evaluate the students' performance and assess the achievement of the learning outcomes made the nomination and reward of the best projects impossible. Whereas this was not perceived as a problem seeing the diversity of the projects and the great effort provided by the students during the summer school, it is nonetheless a challenge the project team has to meet to develop credible teaching material.

4.4 The practitioners

The companies' participants have enjoyed their interactions with the students and valued most of their proposals. Many of them have been impressed by the quality of the final presentation, they have praised the work effectuated during such a short amount of time as well as the creativity of the solutions and have asked to receive the slides of the presentation. The Swedish FM also invited the students to share with them the software they used to support their speech. Whereas some of the practitioners had expressed a form of uneasiness in having to give a feedback to the students as they felt they did not have the competence to judge the students' contribution, they did comment on the feasibility of the solutions. Though being positive on the outcomes, some of their observations brought the students back to the concrete "real life" conditions of their project and highlighted the limitations of nudging the users.

All in all, the summer school was a successful event enjoyed by all the participants. However, the pedagogic contribution to the students' understanding of social challenges related to the development of sustainability is difficult to assess. From the event, we can transfer case descriptions and work setting, but a three days event is difficult to introduce in usual

professional or academic curricula. None of the participating educations could or would deliver credits for the summer school participation. The latter therefore can only appear as an “outside academic programme” activity on the students curriculum vitae.

5. DISCUSSION AND CONCLUSION

Whereas describing the context, process and goals of the spring school, has been a rather straightforward defining the outcomes and judging of their qualities appears to be more difficult! If all the participants agree that the summer school was a success, they may have different interpretations of the reasons behind this success. Another unknown feature is related to the quality and deepness of the learning judged on a longer term. Besides, it is difficult to assess what are the consequences on this event, whatever successful it is, in supporting and improving the teaching of sustainable FM in terms of existing education and curricula in the participating institutions. It seems challenging to recreate and share the tension and motivation built by the physical presence of the different actors Like other innovation process in large organization, the summer school creates a liminal space which needs to be shared and translated to more than the participants to realize its potential.

6. REFERENCES

- Blumenfeld, P.C., Soloway, E., Marx, R.W., Krajcik, J.S., Guzdial, M. and Palincsar, A., 1991. Motivating project-based learning: Sustaining the doing, supporting the learning. *Educational psychologist*, 26(3-4), pp.369-398.
- Bryman, A. and Bell, E., 2015. *Business research methods*. Oxford University Press, USA.
- Buser M., Koch C. 2014 Is this none of the contractor’s business? Social sustainability challenges informed by literary accounts. *Construction Management and Econ.*, 32, (7-8): pp 749-759.
- Elle, M., Engelmark, J., Jørgensen, B., Koch, C., Balslev Nielsen, S. and Vestergaard, F., 2004. Managing facilities in a Scandinavian manner: creating a research agenda. *Facilities*, 22(11/12), pp.311-316.
- Elmualim, A., Shockley, D., Valle, R., Ludlow, G. and Shah, S., 2010. Barriers and commitment of facilities management profession to the sustainability agenda. *Building and Environment*, 45(1), pp.58-64.
- Elmualim A. 2009 Sustainable management in built environment needs more support. Science for Environment Policy: DG Environment News Alert Service, European Commission. The University of West England, Bristol.
- Figueiró, P.S. and Raufflet, E., 2015. Sustainability in higher education: a systematic review with focus on management education. *Journal of Cleaner Production*, 106, pp.22-33.
- Lim, Y.S., Xia, B., Skitmore, M., Gray, J. and Bridge, A., 2015. Education for sustainability in construction management curricula. *International Journal of Construction Management*, 15(4), pp.321-331.
- Maliene, V., Alexander, K. and Lepkova, N., 2008. Facilities management development in Europe. *International Journal of Environment and Pollution*, 35(2-4), pp.171-184.
- Mauser, W., Klepper, G., Rice, M., Schmalzbauer, B.S., Hackmann, H., Leemans, R. and Moore, H., 2013. Transdisciplinary global change research: the co-creation of knowledge for sustainability. *Current Opinion in Environmental Sustainability*, 5(3), pp.420-431.
- Lozano, R., Ceulemans, K. and Seatter, C.S., 2015. Teaching organisational change management for sustainability: designing and delivering a course at the University of Leeds to better prepare future sustainability change agents. *Journal of Cleaner Production*, 106, pp.205-215.
- Lozano, R., 2014. Creativity and organizational learning as means to foster sustainability. *Sustainable development*, 22(3), pp.205-216.
- Ratiu, C. and Anderson, B.B., 2015. The multiple identities of sustainability. *World Journal of Science, Technology and Sustainable Development*, 12(3), pp.194-205.
- Sarpin, N., Yang, J. and Xia, B., 2016. Developing a people capability framework to promote sustainability in facility management practices. *Facilities*, 34(7/8).
- Savery, J.R., 2015. Overview of problem-based learning: Definitions and distinctions. *Essential readings in problem-based learning: Exploring and extending the legacy of Howard S. Barrows*, pp.5-15.

- Trencher, G., Terada, T. and Yarime, M., 2015. Student participation in the co-creation of knowledge and social experiments for advancing sustainability: experiences from the University of Tokyo. *Current Opinion in Environmental Sustainability*, 16, pp.56-63.
- Tuomela, A. and Puhto, J., 2001. *Service provision trends of facility management in Northern Europe*. Teknillinen korkeakoulu.
- Wilson, G. and Pretorius, R.W., 2017. Utilising Work-Integrated Learning to Enhance Student Participation and Engagement in Sustainability Issues in Open and Distance Learning. In *Handbook of Theory and Practice of Sustainable Development in Higher Education* (pp. 245-257). Springer International Publishing.
- Wright, T.S. and Wilton, H., 2012. Facilities management directors' conceptualizations of sustainability in higher education. *Journal of Cleaner Production*, 31, pp.118-125.

AN ANALYSIS OF RESEARCH TRENDS IN CONSTRUCTION PROJECT MANAGEMENT

P. I. Cakmak and B. Ilhan

Architecture, Istanbul Technical University, Taskisla, Taksim, Istanbul, 34437, Turkey

Email: irlayici@itu.edu.tr

Abstract: Construction industry requires qualified professionals for managing project processes becoming increasingly complicated. Institutions associated with project and construction management field educate those professionals by providing practical skills as well as theoretical knowledge in order to manage social, technological, financial and environmental issues. Accordingly, academic studies on project and construction management should be addressed in accordance with the industry needs. This study determines the state of academic studies in Turkey by analysing the master theses completed in Project and Construction Management (PCM) graduate program at Istanbul Technical University (ITU). The main purpose is to find out the change of research tendency over the years, to indicate the areas concentrated on and gaps for potential studies. The results of the analysis will guide for further researches in the related field. Recommendations for potential research interests will be given by considering the industrial needs and problems.

Keywords: construction industry, education, project and construction management, research trends.

1. INTRODUCTION

Construction project management is an independent profession and has been carried out in the architectural, engineering and construction (AEC) industry all around the world for many years. Construction project management utilises project management techniques to plan, design, and build a construction project from its initiation to completion. Construction management is broadly defined to include project management, construction economics, design economics, cost engineering, value engineering, construction law and procurement, industrial management and public policy related to the construction industry (Wing, 1997).

Project Management Institute (PMI, 2013) defines project management as the application of knowledge, skills, tools, and techniques to project activities to meet project requirements. PMI mainly focuses on 9 knowledge areas including integration management, scope management, time management, cost management, quality management, human resource management, communications management, risk management, and procurement management. In 2003, PMI published the Construction Extension (PMI, 2016) to support for project management practitioners specifically in construction industry. 4 new construction unique project management knowledge areas are added. These are safety management, environmental management, financial management and claim management.

Today construction project management is an established academic and research area that builds upon a long series of publications of scholarly work and debate (Pietroforte and Stefani, 2004). There are various studies concentrated on the trends in construction project management researches. Themistocleous and Wearne (2000) present an analysis of the relative frequency of attention to Body of Knowledge topics of project management in the papers published in the International Journal of Project Management from 1984 to 1998. The results show that project planning, monitoring and control, risk analysis, information management, contracts and related

classical problems of project execution have had good attention. Another study provides a historical perspective on construction research trends by reporting an 18-year analysis of Journal of Construction Engineering and Management (Abudayyeh et al., 2004). The top research topical areas are scheduling, productivity, constructability, simulation, cost control, planning, safety, and computer systems. The trends of emphasis within the project management literature over the period 1994–2003 are analysed through the articles in the International Journal of Project Management and the Project Management Journal (Crawford et al., 2005). The results of the study revealed that relationship management, resource management, time management, cost management and risk management displayed consistent significance throughout the study period; however, by contrast, finalisation, scope and marketing tend to either be ignored or identified as not being of significance. Kwak and Anbari (2009) examine project management research from the perspective of its relationship to allied disciplines in the management field and provide a view of the progress of project management as a research-based academic discipline. The ranking of occurrences of eight allied disciplines from most to the least appeared subjects over the last 50 years are (1) strategy/portfolio management; (2) operations research/decision sciences; (3) organizational behaviour/human resources management; (4) information technology/information systems; (5) technology applications/innovation; (6) performance management/earned value management; (7) engineering and construction; and (8) quality management/six sigma.

Construction project management is not only a construction practice, but also a widely accepted field in higher education; and there are many undergraduate and graduate programs. In the United States, it started with the development of pioneering master's programs approximately 45 years ago, followed by PhD programs 5 years later (Carr, 1997). In Turkey, construction project management subject was first taken part within a number of undergraduate courses in the Faculty of Architecture at Istanbul Technical University (ITU). In 1973, the first construction project management master program was established in the same faculty at ITU and has been carrying on to educate construction management professionals since then. The program is designed to expose students to the latest advancements in construction project management, develop advanced competencies in the technical, management, and leadership aspects of professional construction project management, provide advanced preparation in the technical aspects and human factors of the construction industry, and create an awareness of the global aspects of construction project management.

This study focuses on the construction project management researches within the context of Project and Construction Management (PCM) graduate program at ITU. The aim of the study is to explore the research trends over the years and reveal the most addressed and least discussed subjects. In order to reach this aim we examine the master theses completed in the program between 1990 and 2016.

2. RESEARCH DATA AND METHODOLOGY

Construction project management related studies are accessed through various sources such as journal and conference papers, master and PhD theses, and reports. Within the scope of this study, master theses completed in PCM graduate program by using meta-classification system. The meta-classification of previous work is important for the analysis of a discipline, inter-relating different focus areas of study and identifying emerging or neglected themes (Betts and Lansley, 1993). The meta-classification system used in this study is shown in Table 1.

Table 1: Meta-classification system

Dimension	Category	Attribute
Content	Main subject	Change management, Construction industry, Cost management, Design management, Dispute resolution, Education, Facility management, Organisational behaviour / Human resources management, Information systems, International construction, Managerial approaches, Procurement management, Quality management, Real estate management, Risk management, Safety management, Site management, Sustainability, Time management
	Study level	Firm, Product, Project, Sector
Source	Methodology	Case Study, Mathematical modelling, Model development, Review, Survey / interview, Theoretical model
Author	Profession	Architect, Civil engineer, Urban planner
	Gender	Female, Male
General	Year	1990-2016
	Area	Keywords related to project and construction management

The meta-classification system consists of four main dimensions including content, source, author, and general. Each dimension has its own categories and related attributes. The master theses are analysed against this classification system and categorised generally by one of the attributes.

3. ANALYSIS AND RESULTS

The analysis shows that there are 260 master theses completed within the PCM graduate program between 1990 and 2016. The distribution of master theses within the specified time period is presented in Figure 1. The data are given for five-year period except 2015-2016. The majority of the master theses are completed between 1995 and 2009. There is a decrease by 2010 as a result of a regulation change regarding time allowed for graduation.

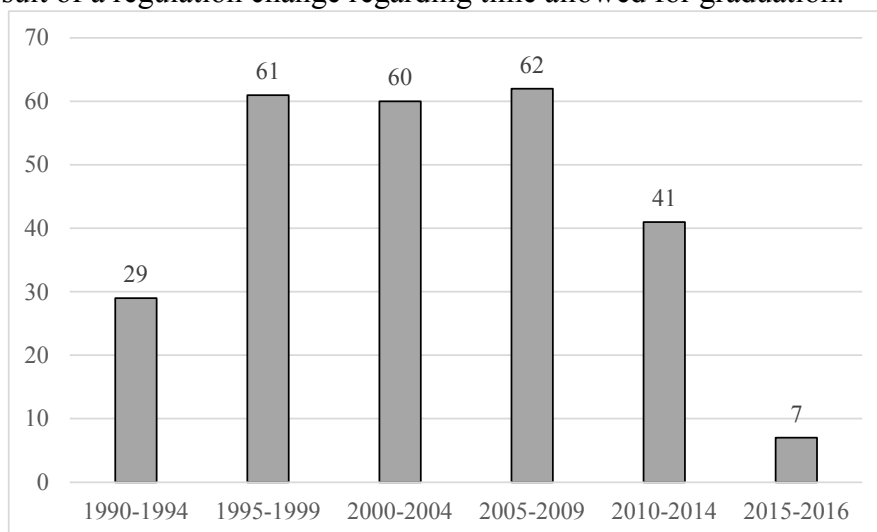

Figure 1: Theses within the timespan

Figure 2 shows the distribution of master theses according to their main subjects. The theses are grouped by analysing their titles and abstracts. Main subjects are determined as change management, cost management, design management, dispute resolution, education, facility management, organisational behaviour / human resources management, information systems, international construction, managerial approaches, procurement management, quality management, real estate management, risk management, safety management, site management, sustainability, and time management. The theses that do not match these categories, discussing general construction issues are listed in the construction industry main subject. Construction industry, cost management, procurement management, and managerial approaches comprise the most addressed main subjects. Considerable amount of theses deals with information systems, organisational behaviour / human resources management, quality management, design management and dispute resolution. Following these main subjects, international construction, time management, risk management, education, site management and sustainability are next handled ones. The least studied subjects are safety management, facility management and real estate management.

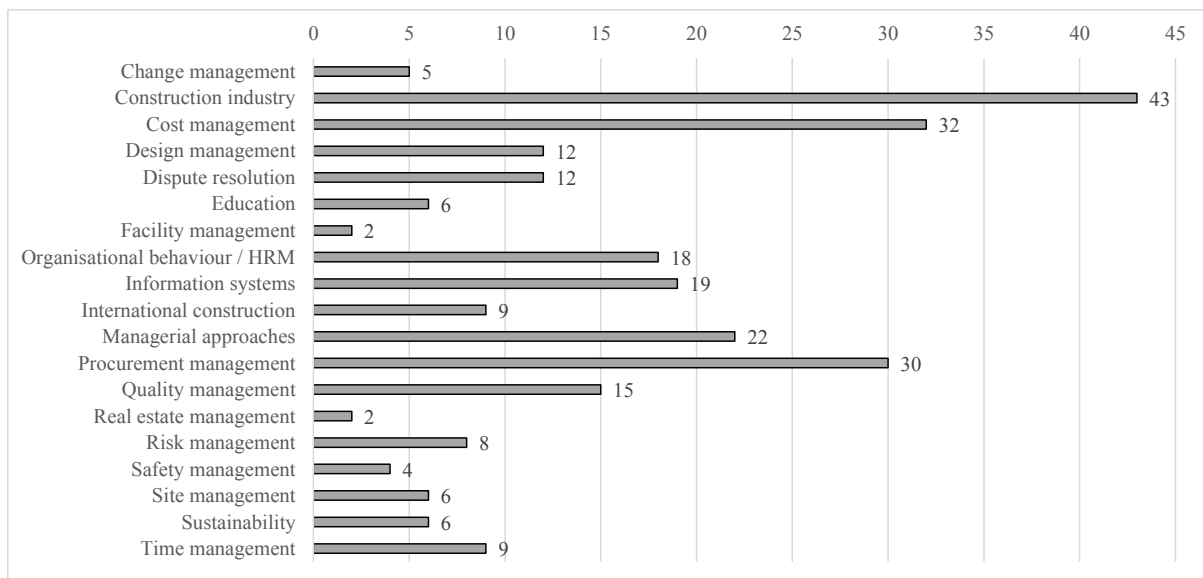

Figure 2: Theses within the main subject

On the other hand, occurrences of 19 main subjects are shown in Figure 3 according to specified years. While cost management is the most trend subject between 1990 and 1994, its frequency has gradually decreased by years. Even though information systems in construction was not a preferred subject around 1990s, it becomes the most popular one by 2015. Similarly, dispute resolution, safety management and sustainability show an increasing tendency over the years. International construction, change management, organisational behaviour / human resources management, risk management, time management, managerial approaches, design management, and procurement management are the main subjects that keep their frequencies by years. On the other hand, site management, quality management and education have started to lose their popularity. Facility management and real estate management have not appeared since 2004.

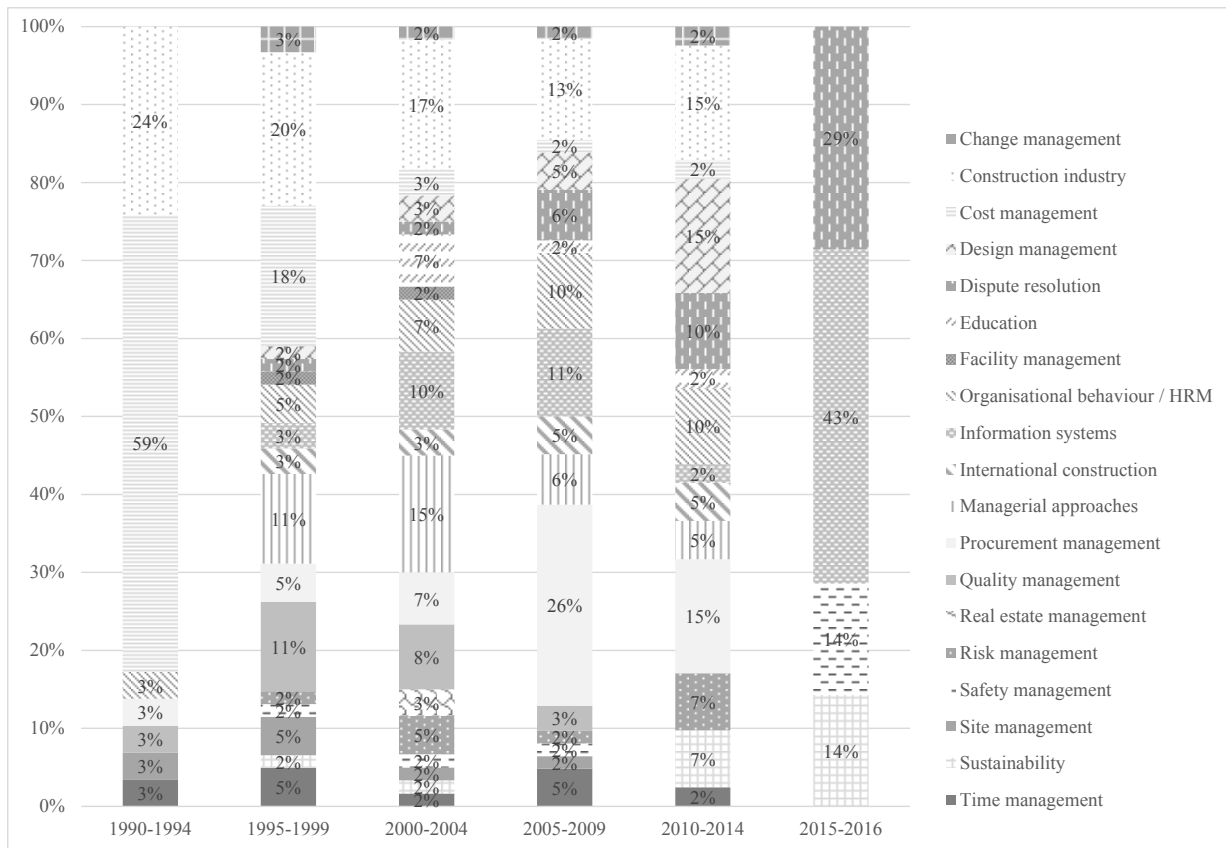

Figure 3: Distribution of the main subjects within the timespan

The theses are examined according to study level in the content dimension. Figure 4 presents the distribution of the study levels of the theses within the timespan. The majority of the theses are studied in the sector level. While firm and project study levels have an equal rate, only 5% of theses deal with product level.

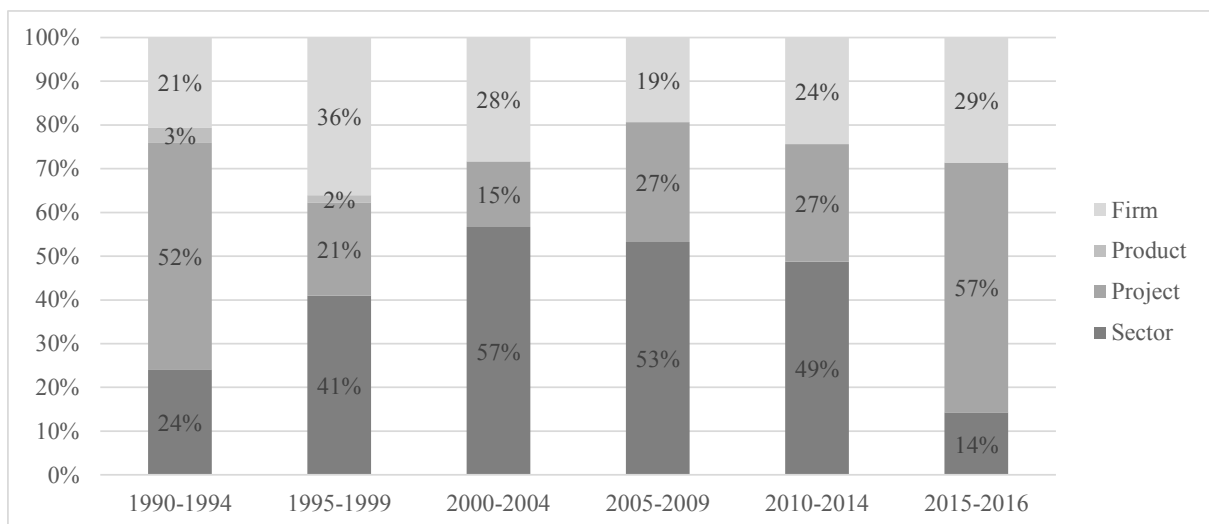

Figure 4: Distribution of the study level within the timespan

Next, the theses are examined in terms of source of information. In Figure 5, the distribution of the methodologies used in the theses are given within the timespan. Survey / interview and review are the most used methodologies. Although it has a decreasing tendency, case study is

the next preferred method. Theoretical model, mathematical modelling, and model development are relatively less used methods over the years.

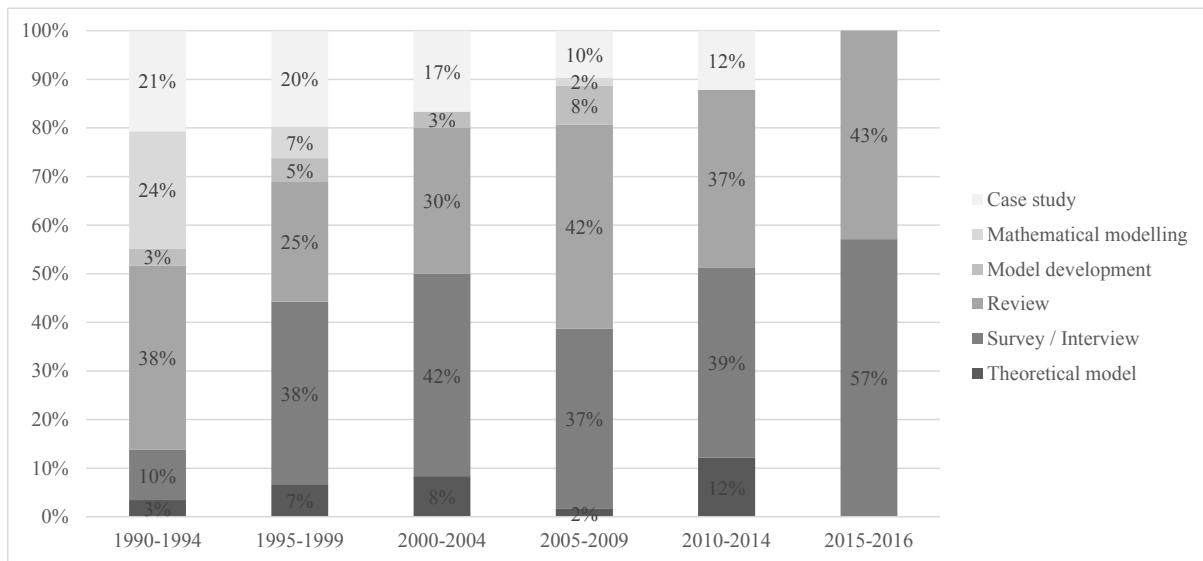

Figure 5: Distribution of the methodology within the timespan

In the author dimension of the meta-classification system profession and gender categories are examined. Professions of the authors are given in Figure 6. Even though various professions are accepted in the PCM graduate program, the professions are predominantly architects. In the last years, there is an increase in the number of civil engineers. In 1995, only one urban planner graduated from the program.

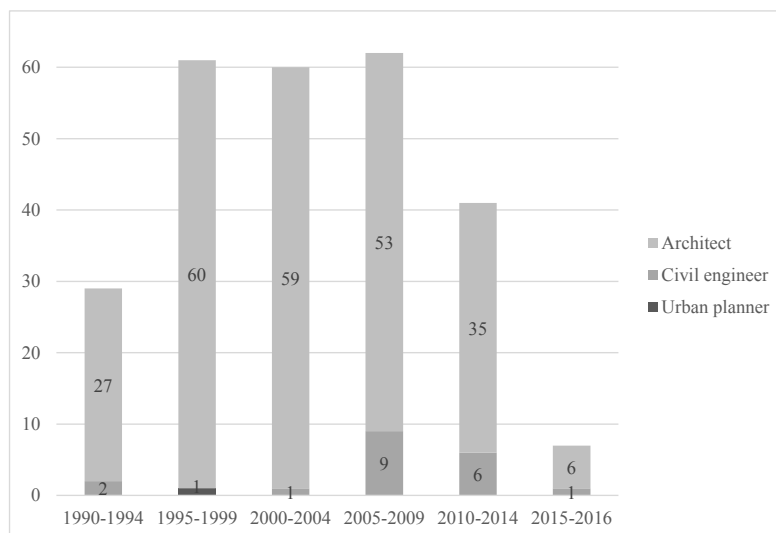

Figure 6: Professions within the timespan

The other category of the author dimension is gender. As it is shown in Figure 7, 174 of 260 authors are females. The difference between males and females has the maximum value in the years of 2000 and 2004.

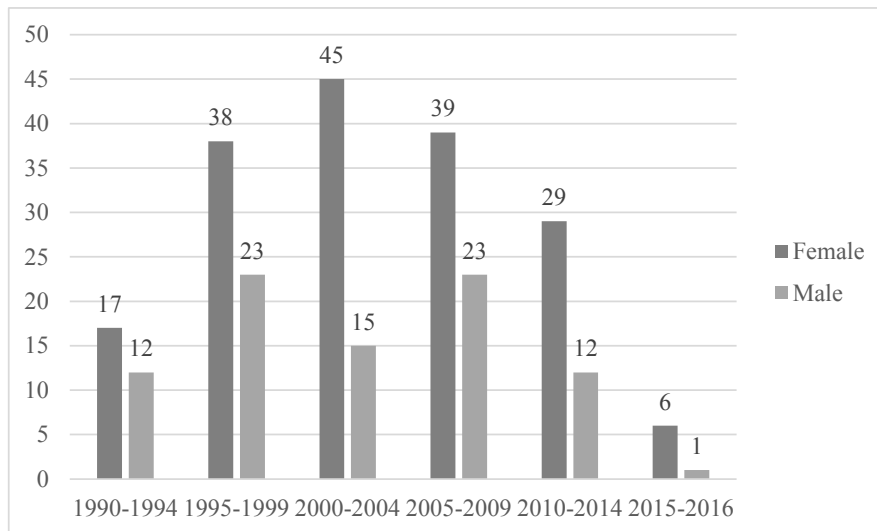

Figure 7: Gender within the timespan

Table 2 represents the keywords of the analysed theses in terms of their frequencies. The specified keywords are determined by analysing theses' titles and abstracts. A total of 550 keywords are identified. Identified keywords are grouped under the related main subject. For instance, under the change management main subject, there are three keywords including project changes, client requirements, and resistance with the frequency of 82%, 9%, and 9% respectively. Besides, the total frequency of the keywords of change management main subject is 2.0% among all 19 main subjects. It is shown that keywords of construction industry have the largest rate with 20.0%. The keywords that are related to education (0.7%), facility management (0.7%), and real estate management (0.5%) have fewer occurrences compared to others. Construction professionals (54), standard contract documents (27), construction contracts (23), contract documents (22), housing & mass housing (18), Building production (16), and cost estimation (15) are the most apparent keywords among analysed theses. On the other hand, client requirements, resistance, document management, drawing standards and equipment management keywords are mentioned only once.

Table 2: Analysis of thesis keywords

Main subject	Keyword	Nbr.	Fre. (%)	Total Fre. (%)
Change management	Project changes	9	82	2.0
	Client requirements	1	9	
	Resistance	1	9	
Construction industry	Building production	16	15	20.0
	Construction professionals (architect, construction manager, consultant, contractor, owner, and subcontractor)	54	50	
	European Union	4	4	
	Housing & mass housing	18	17	
	Marketing	3	3	
	Productivity	4	4	
	Other	10	9	
Cost management	Cost	6	12	9.1
	Cost analysis & planning	14	28	
	Cost control	5	10	
	Cost estimation	15	30	
	Finance	6	12	
	Other	4	8	
Design management	Architectural design services	9	60	2.7
	Design process	4	26	
	Document management	1	7	
	Drawing standards	1	7	
Dispute resolution	Alternative dispute resolution	7	27	4.7
	Conflict & conflict management	10	38	
	Dispute & dispute factors	9	35	
Education	Architectural career & education	2	50	0.7
	Graduate programmes	2	50	
Facility management	Maintenance, repair & operation	4	100	0.7
Information systems	Building information modelling	4	12	6.0
	Computer aided	7	21	
	Information technology	13	39	
	Knowledge management	4	12	
	Other	5	15	
International construction	Culture	8	67	2.2
	Joint ventures	4	33	
Managerial approaches	Competitiveness	8	20	7.0
	Reengineering	3	7	
	Strategy & strategic management	15	39	
	Total quality management	6	14	
	Other	8	20	
Organisational behaviour & Human resources management	Communication	4	12	6.2
	Human resources planning	4	12	
	Job satisfaction	3	9	
	Leadership	3	9	
	Organisational structure	3	9	
	Performance management	4	12	
	Personnel management	5	14	
	Other	8	24	
Procurement management	Bidding & tendering	6	6	19.1
	Claim	5	5	
	Construction contracts	23	22	
	Construction law	5	5	
	Contract documents	22	21	
	Payment	4	4	
	Project delivery systems	8	8	
	Public procurement	5	5	

	Standard contract documents	27	25	
Quality management	Control & inspection	8	23	6.4
	ISO9000	5	14	
	Quality	10	29	
	Quality control & quality assurance	12	34	
Real estate management	Real estate development	3	100	0.5
Risk management	Entrepreneurship	2	11	3.3
	Risk	11	61	
	Risk analysis & risk assessment	5	28	
Safety management	Health & safety	6	75	1.5
	Work accidents	2	25	
Site management	Construction site	2	17	2.2
	Equipment management	1	8	
	Labour & labour management	9	75	
Sustainability	Certification systems (LEED, BREEAM)	6	46	2.4
	Green building	2	15	
	Sustainable construction	5	38	
Time management	Delay & delay analysis	3	17	3.3
	Planning & programming	8	44	
	Resource planning	2	11	
	Time estimation	5	28	
Total		550		100

In some main subjects there are “other” keywords referred in Table 2. Due to space limitation “other” keywords are written here. Construction industry other keywords are construction technology, critical success factors, deconstruction, e-business, economic crisis, innovation, input-output tables, and value engineering. Cost management other keywords are bill of quantities, cash flow, and feasibility study. Information systems other keywords are data modelling, database, ERP, and web-based applications. Managerial approaches other keywords are benchmarking, business processes, just in time management, lean management, and supply change management. Organisational behaviour / Human resources management other keywords are gender, learning & learning styles, mobbing, motivation, organisational commitment, and team work.

4. DISCUSSIONS AND CONCLUSION

In this study, the construction project management concept, which has a great impact and importance in the AEC industry and academia, is examined via meta-classification system. In this context, a total of 260 master theses completed between 1990 and 2016 within the PCM graduate programme at ITU are analysed in terms of different dimensions in order to evaluate the research trends and gaps. The results of the analysis show that general aspects of the construction industry is the most discussed main subject even though it has a decreasing tendency over the years. Authors concentratedly focus on cost management as a main subject until 2000. Conversely, procurement management gains attention after 2005. Managerial approaches are discussed mostly in the early 2000s when strategic management and competitiveness concepts were popular among construction firms. With the development of technological tools and innovations, information systems related to construction project management have rapidly been taken part in thesis researches. This has a positive effect on today’s industry, since it allows integration between practice and theory. Similarly, there is an increasing interest on dispute resolution in recent years. The main reason for this interest can be explained with the recent growth and usage of alternative dispute resolution techniques. The studies related to sustainability have also increased recently due to its great potential for greener

design and construction. Main project knowledge areas including time management, risk management, quality management, and human resources management are the main subjects that have continued to be relevant by years. Design management has always been a main subject since 1995; especially after 2010 it gained a rapid importance. As large Turkish construction firms play a key role on Russian and Middle Eastern construction industries, there are also these dealing with the concepts of culture and/or joint ventures under the international construction main subject. On the other hand, there has been very few studies on change management, facility management, education, real estate management, safety management, and site management. Due to the lack of researches on these main subjects, future studies should be directed to these neglected main subjects. All mentioned main subjects in our study are essential for the development of construction project management field; however, the industrial needs and problems should shape further researches. Moreover, the focus should be on increasing research collaboration between industry, academia, and government to improve the AEC industry.

5. REFERENCES

- Abudayyeh, O., Dibert-DeYoung, A. and Jaselskis, E., 2004, *Analysis of trends in construction research: 1985–2002*, Journal of Construction Engineering and Management, 130(3), 433-439.
- Betts, M. and Lansley, P., 1993, *Construction management and economics: a review of the first ten years*, Construction Management and Economics, 11(4), 221-245.
- Carr, R. I., 1997, *Engineering and construction management: leadership and opportunity*, Journal of Construction Engineering and Management, 123(3), 292-296.
- Crawford, L., Pollack, J. and England, D., 2006, *Uncovering the trends in project management: Journal emphases over the last 10 years*, International Journal of Project Management, 24(2), 175-184.
- Kwak, Y. H. and Anbari, F. T., 2009, *Analyzing project management research: Perspectives from top management journals*, International Journal of Project Management, 27(5), 435-446.
- Pietroforte, R. and Stefani, T. P., 2004, *ASCE Journal of Construction Engineering and Management: Review of the years 1983–2000*, Journal of Construction Engineering and Management, 130(3), 440-448.
- PMI, 2013, A Guide to the Project Management Body of Knowledge (PMBOK Guide), PMI, PA, USA.
- PMI, 2016, Construction Extension to A Guide to the Project Management Body of Knowledge (PMBOK Guide – 2000 Edition), PMI, PA, USA.
- Themistocleous, G. and Wearne, S. H., 2000, *Project management topic coverage in journals*, International Journal of Project Management, 18(1), 7-11.
- Wing, C. K., 1997, *The ranking of construction management journals*, Construction Management & Economics, 15(4), 387-398.

FACTORS IMPACTING UPON STUDENT EXPECTATIONS AND SATISFACTION WITH THE QUALITY OF EXPERIENCE OF HIGHER EDUCATION IN ENGLAND

J. Cross and L. Ruddock

School of the Built Environment, University of Salford, Salford Crescent, M5 4WT, UK

Email: j.cross@salford.ac.uk

Abstract: Significant changes have occurred within the higher education sector in England with further changes are anticipated as a result of the changes to the on-going policy development related to higher education in England. Government policy development from Dearing (1997) through to Browne (2010) has introduced major changes to the funding, structure and governance of the HE sector. This development has continued with the proposals to introduce more choice and competition into the HE sector along with measures to deliver teaching excellence, with the publication of the White Paper “Success as a knowledge Economy: Teaching Excellence, Social Mobility and Student Choice” (2016). The impact of the on-going policy development has resulted in greater access to higher education but also increased financial pressures on students and their family. This paper assesses the impact of the continuing policy changes on the provision of higher education in England and the impact on the student experience. The National Student Survey (NSS) is an important measure of student satisfaction and is proving to be a key policy driver in HEI’s relating to quality of provision. The built environment subject area has benefited from the widening participation agenda and as a result, the diverse demographics of the student population create a complex mix of student expectations within a built environment school. The research methodology included a literature review and semi-structured interviews seeking qualitative data to explore the factors affecting student expectations and the perception of quality of experience. The findings of the research indicates that the ability of an institution to understand and meet student expectations relating to quality of experience, employability and in other key measures of satisfaction such as NSS and TEF, are central to the continued supply chain of students into universities and industry.

Keywords: Education Management, Higher Education, Policy, Student Experience

1. INTRODUCTION

The increasing importance of the student experience has developed with the idea that students should be ‘*at the centre of the process of learning and teaching*’ (Dearing Report, 1997). This development has been reflected in many influential government reports in the UK and is closely related to the development in government policy towards higher education leading to the recent introduction of the teaching excellence framework (TEF) (BIS, 2015:2016). *Students at the Heart of the System*, includes a chapter exploring ‘*better student experience and better qualified graduates*’ (BIS, 2011) and identifies the ‘*student experience*’ as one of the three challenges the government’ reforms aimed to tackle. The report asserts that ‘*institutions must deliver a better student experience; improving teaching, assessment, feedback and preparation for the world of work*’ (BIS 2011). It goes on to argue that ‘*all universities must offer a good student experience to remain competitive*’ (BIS 2011) and goes on to state: “*The changes we are making to higher education funding will in turn drive a more responsive system. To be successful, institutions will have to appeal to prospective students and be respected by employers. Putting financial power into the hands of learners makes student choice meaningful.*” The 2011 White Paper calls for ‘*a new focus on the student experience and the quality of teaching*’ while the ‘*overall goal is higher education that is more responsive to student choice, that provides a better student experience and that helps improve social mobility.*’ (BIS 2011). It is evident that the officially approved understanding of the student

experience is inseparable from the idea that students should be judges of the quality of higher education. The power of students to demand satisfaction and to choose among alternatives will oblige higher education institutions (HEI's) to become more reactive to their needs.

The introduction of the National Student Survey (NSS) and more recently the Key Information Set (KIS) data has the potential to significantly impact on the reputation, research income and student recruitment is also a significant challenge for many institutions. The use of NSS data to inform the numerous league tables and also as part of the information provided to students as part of the university application process has resulted in universities operating in a more competitive and market driven environment. Asthana and Biggs (2007) argued that the National Student Survey (NSS) has become increasingly important in the decision making process for students in selecting which University they will attend. Recruitment and retention of students has moved up the agenda of most universities' due the policy to increase the UK student population in line with Government targets. Poor retention rates have adverse funding consequences for institutions (Rowley, 2003). Thus recruitment, student satisfaction and retention are closely linked and student satisfaction has become an extremely important issue for universities and their management. As a result, it is in the interest of higher education providers to maximise students' satisfaction with their experience while at university and minimise dissatisfaction. Focussing resources on critical areas relating to improving the student experience and ultimately, student satisfaction is significant for institutions seeking to attract and retain students. Ultimately, understanding the key drivers to ensuring satisfaction for both the providers and participants of higher education will ensure delivery of an efficient and effective higher education system which meets the needs of country, industry and end users. The results of the National Student Survey (NSS) reveal that the overall satisfaction levels with built environment programmes are on average lower than that of other subjects (Higher Education Academy, 2012). Built environment programmes have consistently underperformed on the National Student Survey when compared to the "all subject" results. It is important to understand the reasons for the lower satisfaction levels to ensure these issues can be addressed to produce a more positive outcome. Therefore, the aim of this paper is to identify which aspects of the student experience are critical for enhancing built environment student satisfaction rates.

2. LITERATURE

The concept of the 'student experience' and what is being measured by the various surveys (such as the National Student Survey, HEPI-HEA Student Academic Experience Survey and the Times Higher Student Experience Survey) are not always aligned. The student experience could be defined as including all aspects of the student interaction with their chosen institution including (a) the marketing, application and admissions processes, (b) the teaching, learning and assessment, (c) the resources available and the campus experience and (d) how the institution supports the student transition into employment on graduation. The institutional response from the different institutions has been varied and can be categorised by the type of institution (Temple *et al.*, 2014) with the more research-intensive universities responding differently to more teaching focused institutions. The introduction of surveys such as the NSS has led to a cultural shift in higher education in recognising and responding to student feedback related to their experiences. The experience of students will be affected by a range of institutional responses in terms of the policies and procedures introduced in response to the ongoing government policy developments and the institutional strategy and it should not just be considered an issue affecting course teams or individual academic's. Internal facing policies

such as human resource policies, funding of the estate requirements and organisation and management of resources that are not readily associated with the narrow view of the student experience being related to the learning experience but have a significant impact on the student.

The student experience as a distinct set of linked activities to be managed is a relatively recent phenomenon. Many factors could be identified as being included in the student experience but like all experiences, likely to be unique to each individual (Kolb, 1984). Much of the literature related to the student experience in the context of higher education concentrates on particular aspects of the experience for students notably on the teaching and learning and on particular groups of students such as mature, part-time or international students (Temple *et al.* 2014). The idea of managing the whole student experience is relatively new in higher education and is first expressed in the 1990's by Haselgrove in the text, *The Student Experience* published in 1994. The book considered an approach to the measurement of student satisfaction taken by the then University of Central England that defined a set of indicators linked to student satisfaction (Green *et al.*, 1994) to include (a) travel to the institution, (b) access to facilities such as the library, computer rooms, catering, (c) support mechanisms, (d) teaching and learning, (e) social activities and (f) financial matters. The students were surveyed regarding these issues and the results analysed to inform "*a set of priorities on which management attention can be focussed*" (Haselgrove, 1994). The link between student satisfaction and educational quality was not proven given the varied expectations of the students (Green *et al.*, 1994).

As the debate continues regarding the idea of student satisfaction indicating quality, the significance attached to the view of the student body on matters of academic judgement it remains a concern of many commentators. Staddon and Standish (2012) suggest that the focus on the student perspective "*puts students in a relation to their learning that is very different to what has traditionally been the case...authority is now being ceded to the novice – to those who might once have been thought of as standing in need of induction and, hence, as unable to understand well...the nature of this [educational] good*" and further suggests "*to see student choice as the arbiter of quality is an abnegation of responsibility on the part of providers of higher education. Standards are not raised but abandoned*" (cited in Temple *et al.*, 2014). It should be noted that the link between student satisfaction and quality in terms of educational gain and performance is not evidenced within the literature (Gibbs, 2012). To some extent, the introduction of the National Student Survey (NSS) by the Higher Education Funding Council for England (HEFCE) in 2005 confirms the concept that the student has moved from a being in partnership with their institution in advancing their studies to a consumer of its services (Aldridge, 1998). However, there is a general consensus that satisfaction comes from the meeting of expectations.

Expectations are the benchmark by which a customer measures a service experience and they may be realistic or unrealistic. Satisfaction is derived from a number of components linked to customer expectations and needs. Linking satisfaction to those components can explain differences in satisfaction levels and indicate where service providers can most effectively improve their service to enhance satisfaction. Research undertaken by Cadotte and Turgeon (1988) into customer satisfaction is concerned with identifying the drivers of satisfaction and/or dissatisfaction. The interesting aspect of this research is that it suggests that fixing all the dissatisfiers will not necessarily create satisfied customers. Douglas *et al.*, (2008) identified that there are a small number of 'critically critical' determinants important in achieving student satisfaction, namely, '*communication and responsiveness within the teaching, learning and assessment environment, and access and responsiveness within the ancillary services*

environment'. They found that for students the main sources of dissatisfaction are *'attitude, responsiveness, tangibles, team work, communication, management, access and socialising...communication and responsiveness are the most crucial determinant of quality as it is a major source of satisfaction and dissatisfaction within the area of teaching, learning and assessment and are likely to lead to changes in behaviour and are therefore "Critically Critical"; and usefulness is a major satisfier in teaching, learning and assessment, but not a significant dis-satisfier'*.

In support of this view, Rogers and Smith (2011) identified that the strongest predictor of student satisfaction was the students' perceptions that staff showed genuine interest in their learning needs and progress. They found that students' value academic staff that are genuinely interested in their needs and progress. The ability of an institution to translate the areas that are likely to result in satisfied students can be challenging given the many competing factors needing to be resourced at a time of keen competition to attract students and therefore income to the institution. Therefore the ability of an institution to balance the needs of the institution with the expectations of students will be crucial to future success. These concepts are applicable to the outputs of the NSS because deliverers of built environment courses need to recognise expectations, respond where possible, and sensibly manage expectations where response is not possible.

The literature shows that 'the student experience' is central to government higher education policy throughout the UK, and especially to learning and teaching policies. This is further evidenced with the introduction of the Teaching excellence Framework (TEF) (BIS 2015:2016). The expression 'student experience' is imbued with political thinking and forms an inescapable background to the NSS. However, even in the academic literature 'the student experience' has multiple meanings. The term covers numerous activities at different points in time in a student's life and journey such as their accommodation, social life, extra-curricular and 'consumer' experiences, and careers. So the term is not confined to issues about students' academic experience and their learning and teaching, despite both being inseparable from the student experience. Consequently, there is no single indicator that can capture the multiple meanings of the student experience and it would be unrealistic for a single survey to attempt to address all aspects of the student experience. As the debate continues regarding the idea of student satisfaction indicating quality, the significance attached to the view of the student body on matters of academic judgement it remains a concern of many commentators. Staddon and Standish (2012) suggest that the focus on the student perspective *"puts students in a relation to their learning that is very different to what has traditionally been the case...authority is now being ceded to the novice – to those who might once have been thought of as standing in need of induction and, hence, as unable to understand well...the nature of this [educational] good"* and further suggests *"to see student choice as the arbiter of quality is an abnegation of responsibility on the part of providers of higher education. Standards are not raised but abandoned"* (cited in Temple *et al.*, 2014). It should be noted that the link between student satisfaction and quality in terms of educational gain and performance is not conclusively evidenced within the literature (Gibbs, 2012). As demonstrated, there is also a lack of agreement within the literature regarding what constitutes teaching excellence in the higher education sector (BIS, 2016).

The research study seeks to understand the diversity of the student cohorts within built environment education and the complexity of the expectations the students bring with them and propose ways to enhance the experience for all students within the cohort. The literature indicates that many factors contribute to the overall perception of the quality of the educational

experience producing a very complex picture. The institutional context coupled with factors such as the student cohort demographics and programme of study result in difficulties producing a ‘one-size fits all’ solution.

3. METHODOLOGY

30 students from across all construction related undergraduate programmes within one HEI offering a range of built environment programmes were invited to take part to reflect the experiences of students at different levels of study rather than limit it to level 6 when the NSS takes place. This sample included students from both the full time and part time modes of study as shown in table 1 below.

Table 1

Programme of study	Mode of study	No. of participants
BSc (Hons) Quantity Surveying	Full Time	6
BSc (Hons) Quantity Surveying	Part Time	4
BSc (Hons) Building Surveying	Full Time	6
BSc (Hons) Building Surveying	Part Time	2
BSc (Hons) Construction Project Management	Full Time	5
BSc (Hons) Construction Project Management	Part Time	3
BSc (Hons) Architectural Design Technology	Full time	4

A non-probability sampling technique was used to select students to participate in the study. The samples are unlikely to be statistically representative of the total population but they will provide the depth of insight required to meet the aim. Purposive sampling using a heterogeneous sampling technique was used to select the interviewees to participate in the research. The students were selected based on the programme of study, the mode of study and gender to ensure a representative sample to include all of the identified groups within the case study. Students at level 5 and 6 of the identified programmes were contacted by email and asked to participate in the research interview. The students at Level 6 were invited to participate but the interviews could not be conducted until after the closure of the official NSS to ensure no unintended influence could be put on the student contribution to the actual survey.

The interview questions were designed to address the specific issues identified from the analysis of historic NSS results with in-depth discussion of the issues raised. Open-ended questions were used that defined the areas to be explored but that allowed the interviewer and/or the interviewee to deviate to allow particular issues to be explored in more detail (Saunders *et al.*, 2012). The semi-structured interviews with students consisted of a total of 30 participants from across a range of construction undergraduate programmes including BSc (Hons) Quantity Surveying, BSc (Hons) Building Surveying, BSc (Hons) Construction Project Management and BSc (Hons) Architectural Design Technology from both levels 5 and 6. The participants were encouraged to highlight their own perceptions of their experience of higher education within the given context and in relation to the questions. The interviews revealed a good deal of information regarding what the students considered to be important to them and also how this related to their own personal situation, ambitions and impact of the decision to study on their own life experiences. During the interviews the researcher reflected back on

responses given to check that they had been properly understood and also to prompt more detailed responses to key issues. The data collected as a result of the semi-structured interviews with students was initially analysed using content analysis in Nvivo 10 to organise the data into general themes. Open coding of the data was used to categorise the data into the identified themes and to include any emerging themes not yet identified. Axial coding of the data was undertaken to identify any emerging relationships between the themes. The final phase of the process is to ensure credibility of the findings. The findings were then triangulated against the literature and analysis of the NSS results.

4. RESULTS AND DISCUSSION

How an individual student perceives an experience is very personal to that individual based on many factors such as the socio-economic background of that individual, previous experience of the educational system, age, gender, family and work responsibilities, work and life experience and importantly the expectations of that individual. The complexity of the factors at an individual level will be replicated in some mix within the whole cohort of students. The themes that emerged from the data analysis are summarised below:

4.1 Engagement of academic staff

The results from the analysis suggest that the academic staff are a critical factor in the students either reporting a positive experience or a negative experience. The analysis of the data from the NSS verbatim comments shows academic staff to be a positive influencer or a negative influencer. The students consistently report that lack of engagement or interaction with academic staff members during the timetabled sessions and outside the scheduled sessions is a significant cause of dissatisfaction amongst the student cohort. This is an issue reported in other national surveys of student satisfaction and is shown to be a critical factor for students generally (HEPI-HEA, 2015). The inability or unwillingness of some academic staff members to interact with students is perceived very negatively and is linked in the minds of students with staff who are not interested in their progress, as poorly trained, inexperienced and lacking in any professional background. This issue influences the student perception across the whole range of activities including teaching, assessment and feedback, academic support, organization and management and personal development.

One of the key areas the perceived lack of engagement influences is the overall satisfaction question on the NSS. The data reveals instances where the student's respond to the individual categories on the NSS in a more positive way than they respond to the question regarding overall satisfaction. On exploring this issue with students during the interviews, a number of students report they feel disconnected from their education provider, as they feel some staff members are not interested in them or their success. The motivation of some academic staff to engage with teaching activities has been shown to be an issue. The greater value the institution places on research activities related to the lesser value attached to teaching may have the result of lowering the motivation for staff to commit the time required to fully engage with the students and in preparing high quality interactive lectures. The issue is a complex one connected to the motivations and expectations of academic staff and of the needs of the institution.

The policy and procedures related to the recruitment of academic staff and the reward and recognition policy reflects the strategy of the university in meeting its Key Performance Indicators. At undergraduate level the students tend to focus on the industry and career development within that industry environment rather than considering the benefits and impact of research. The evidence has shown that students value those academic staff that have professional experience in the construction industry and can relate the theory to practice. The academic staff members that have the professional experience are less likely to have a research profile and therefore often find they unable to progress their career in line with expectations as a result. The data reveals some evidence that this is proving to be a demotivating factor related to teaching activities with some doubts apparent as to the benefits for individuals in committing the resources necessary to engage with teaching and the associated training and development.

It is clear from the findings that the academic staff can have a significant impact on the student experience and the policy and procedures related to the recruitment of staff and on-going training and development, reward and recognition policies contribute to the motivation to engage with undergraduate students to ensure they have a positive experience. Managing academic staff expectations relating to their roles and responsibilities is a significant factor in enhancing the student experience.

4.2 Managing expectations

The result of the analysis indicates managing expectations of all stakeholders in higher education to be an important factor in enhancing the student experience. It was evident from the responses that the expectations of students, academic staff, the institution, and the construction industry employers are significant for student satisfaction and in a number of areas are miss-aligned. The evidence suggests students have heightened expectations as a result of the introduction of student fees (Jones, 2010) and due to the vocationally based nature of the courses. The data reveals students have strong expectations of the links to the profession being embedded within the programme of study, to be taught by academic staff that have professional experience within the construction industry and significantly many enter the higher education environment with clear expectations of the outcome of their studies in terms of degree classification. The expectation of some students that the experience of higher education is transactional in nature and the evidence reveals this can negatively impact on the student perception of all aspects of their experience including teaching, assessment, academic support and organization and management.

The data reveals that students have strong expectations of the links to the professions in relation to the content of the programme, the academic staff delivering and managing their modules and also in terms of the direct engagement with construction professionals and professional bodies. Managing the expectations of students of a diverse student cohort also presents challenges for those engaged with built environment higher education. Part-time students represent a significant proportion of the student cohort and as the evidence suggests many of them feel pressure from the workplace in terms of the volume and type of work they are required to undertake and the burden of expectation of the employers. Part-time students often have the performance in their studies linked to their employment resulting in heightened expectations and pressure to succeed.

4.3 Organisation and management

The results from the analysis indicate the strategy for the organization and management of the teaching, assessment and academic support is having a negative impact on the student experience. While the majority of respondents acknowledge the provider has made significant improvements in the timetabling in terms of the location of teaching space and the reduced need to move around the campus to attend lectures, the organization of the actual teaching sessions is proving problematic. The evidence reveals students to be critical of four-hour long lectures in large groups. The lack of interaction in a significant number of these sessions with reports of academic staff reading verbatim from the PowerPoint slides and adding little value is negatively impacting on the student experience. The evidence also suggests that more small group tutorial sessions would improve the student experience and potentially improve the interaction with all module tutors. The data suggests that the organization of the formal structures to facilitate academic support for students is not working efficiently and that a more effective solution would enhance the student experience.

4.4 Industry focus

By their very nature, built environment degree programmes are intrinsically linked with the professions. As the data shows, built environment students expect the course content to be industry relevant and that those teaching them are experienced professionals. These expectations are also apparent with professional bodies and employers of part-time students and those employers who offer graduate employment. Any higher education provider of vocationally based degree programmes will encounter similar expectations and will need to balance the strategic requirements of the institution with the expectations of those engaging in the process of higher education. As previously considered, the expectations of academic staff members in terms of reward and recognition and responsibilities will also need to be managed effectively to ensure effective engagement with the process.

5. CONCLUSIONS

The findings from this study indicate that the quality of the interaction between academic staff and students is a significant factor in the perception of the experience for students and can have a very positive or a very negative impact. The research data demonstrates that the professional experience and background of academic staff members, the motivation and roles and responsibilities of those engaged in teaching undergraduate students plays a significant role in the student experience. The findings also indicate that the nature of built environment degree programmes and the intrinsic link with the construction industry are significant factors in influencing the student expectations. In order to meet the expectations of students and the various stakeholders of built environment higher education, it is necessary to develop links with the construction industry in a variety of ways to reflect the complexity of expectations and knowledge and skills. Students expect explicit reference to current practice within the modules they are undertaking and some contextualization of the theory to current practice. The data shows students particularly value academic staff that are experienced professionals, have teaching qualifications and/or continuous on going training to update teaching skills. This can prove to be problematic for higher education providers that rely on academic staff to engage with research rather than professional (industry) activities.

Providers of built environment higher education may need to review the recruitment policies; reward and recognition policies and on-going training requirements to ensure the knowledge and skills are available within the teaching staff to meet with the expectations of the various stakeholders. Recruiting professionally qualified academic staff also provides an advantage to the employer in that it is a requirement of the professional body for those holding such qualifications to engage in set levels of approved CPD. Providing academic staff members with sufficient support for engaging with research and enterprise activities also provides opportunities to develop links with industry. Strong links with industry also provides opportunities to industry professionals to participate in teaching and assessment activities, provides opportunities for placements and graduate employment and helps the school to maintain currency within its academic programmes. The diverse student population typically found within built environment schools also contributes to the challenges faced by any institution in providing built environment education. The heightened expectations of part-time and mature students coupled with the expectations of full-time students create a challenging environment to understand and provide an educational experience for this student cohort.

The study also reveals that the organization and management of the teaching, assessment and academic support mechanisms impact significantly on the quality of the student experience and are closely related to the student expectations. The data reveals that while the cost of tuition fees has become the accepted norm amongst the student cohort, the evidence suggest students have become very output focused and this is evident in how they view the teaching, assessment and academic support. The study identifies the importance of understanding the student expectations and the relationship between the expectations and the ‘as-lived’ experience of the student group. This relationship is significant in terms of how it can provide a lens that all interactions with the university are viewed through and the ability of the higher education provider to identify and respond appropriately is important in enhancing the student experience.

6. REFERENCES

- Aldridge, S., and Rowley, J. (1998), "*Measuring customer satisfaction in higher education*", *Quality Assurance in Education*, Vol. 6 Iss: 4 pp. 197 – 204.
- Asthana, A. and Biggs, L. (2007), "*Students pay more but receive less*", *The Observer*, 11 February.
- BIS (2015) *Fulfilling our Potential: Teaching Excellence, Social Mobility and Student Choice*. Department for Business, Innovation and Skills. London: HMSO.
- BIS (2016) *Success as a Knowledge Economy: Teaching Excellence, Social Mobility and Student Choice*. Higher Education White Paper. Department for Business, Innovation and Skills. London: HMSO.
- Cadotte, E.R. and Turgeon, N. (1988), "*Dissatisfiers and satisfiers: suggestions for consumer complaints and compliments*", *Journal of Consumer Satisfaction, Dissatisfaction and Complaining Behaviour*, Vol. 1, pp. 74-9.
- Dearing (1997) *Higher Education in the Learning Society, The Report of the National Committee of the Inquiry into Higher Education (The Dearing Report)*.
- Douglas, J. A., Douglas, A., McClelland, R. J., & Davies, J. (2015). *Understanding student satisfaction and dissatisfaction: an interpretive study in the UK higher education context*. *Studies in Higher Education*, 40 (2), 329-349. doi:10.1080/03075079.2013.842217
- Gibbs, G. (2012) *Implications of ‘Dimensions of Quality’ in a market environment*. York: Higher Education Academy.
- Haselgrove, S., & Society for Research into Higher, E. (1994). *The Student experience*. Buckingham: Buckingham: The Society for Research into Higher Education: Open University Press.
- HEA (2012) *NSS Discipline Report – Built Environment*. York: Higher Education Academy.
- HEPI and HEA (2012) *The HEPI-HEA Student Academic Experience Survey 2012*. York and Oxford: Higher Education Academy and Higher Education Policy Institute.
- HEPI and HEA (2013) *The HEPI-HEA Student Academic Experience Survey 2013*. York and Oxford: Higher Education Academy and Higher Education Policy Institute.

- HEPI and HEA (2014) *The HEPI-HEA Student Academic Experience Survey 2014*. York and Oxford: Higher Education Academy and Higher Education Policy Institute.
- HEPI and HEA (2015) *The HEPI-HEA Student Academic Experience Survey 2015*. York and Oxford: Higher Education Academy and Higher Education Policy Institute.
- HEPI and HEA (2016) *The HEPI-HEA Student Academic Experience Survey 2016*. York and Oxford: Higher Education Academy and Higher Education Policy Institute.
- HESA (2010, 2011, 2012, 2013; 2014); 2015 Staff in Higher Education Institutions 2010/11; 2011/12; 2012/13; 2013/14; 2014/15. Cheltenham: Higher Education Statistics Agency.
- Kolb, D. A. (1984). *Experiential learning: experience as the source of learning and development*. Englewood Cliffs, [N.J.]; London: Englewood Cliffs, N.J.; London: Prentice-Hall.
- Lord Browne (2010). *Securing a sustainable future for Higher Education – An independent review of higher education funding and student finance*. BIS, London.
- NCIHE (National Committee of Inquiry into Higher Education) (1997) *Higher Education in the Learning Society (the Dearing Report)* London HMSO.
- Rogers, J., Smith, M. (2011), "*Demonstrating genuine interest in students' needs and progress: Implications for student satisfaction with courses*", *Journal of Applied Research in Higher Education*, Vol. 3 Iss: 1 pp. 6 - 14
- Rowley, J. (2003), "*Retention: rhetoric or realistic agendas for the future of higher education*", *The International Journal of Educational Management*, Vol. 17 No. 6, pp. 248-53.
- Sanderson, R and Bremner C (2015) *Teaching Excellence Framework: Review of Data Sources – Interim Report*. ONS. London.
- Saunders, M. (2012). *Research methods for business students* (6th ed.). Harlow: Harlow: Pearson.
- Staddon, E., & Standish, P. (2012). Improving the Student Experience. *Journal of Philosophy of Education*, 46(4), 631-648. doi:10.1111/j.1467-9752.2012.00885.x
- Temple, P., Callender, C., Grove, L. and Kersh, N. (2014) *Managing the student experience in a shifting higher education landscape*. Report to the Higher Education Academy. York: Higher Education Academy.
- THE ROBBINS REPORT (1963). *Technical Education*, 5(12), 563-606. doi:10.1108/eb015365

A NEW LEARNING APPROACH FOR DIGITAL CONSTRUCTION

S. Gangathepan¹, N. Thurairajah¹, M. Lees¹ and R. Curzon²

¹ School of Engineering and the Built Environment, Birmingham City University, Birmingham, B4 7XG, United Kingdom

² Centre for Excellence in Learning and Teaching, Birmingham City University, Birmingham, B5 5JU, United Kingdom

Email: Sivagayinee.Gangathepan@bcu.ac.uk

Abstract: The construction industry is embracing a journey towards digitalisation, and Building Information Modelling (BIM) is playing a key role in this transformation towards digital construction. However, some studies claim that the lack of BIM-related skills among construction professionals is a major barrier to this change. Therefore, adopting a new learning approach is vital to develop the skills which can produce a radical shift in employees' perception of working to achieve the project goals. Semi-structured interviews were conducted and a case study was examined to evaluate current construction practices. These were viewed through the lens of connectivism to understand the complex learning that happens in a rapidly changing digital world. In connectivism, learning is the formation of connections in a network which is no longer an internal, individualistic activity. This study explores how learning takes place in BIM construction projects and recommends that stakeholders within such projects need to approach their learning environment in a connected way to achieve their project goals. Moreover, this allows people to learn continuously and respond appropriately to information on the changing project environment.

Keywords: Building Information Modelling (BIM), Connectivism, Construction Industry, Digitalisation, Learning Environment.

1. INTRODUCTION

Digitalisation has started to change the way work is organised. According to Berger (2016, p.3), digitalisation is about "...businesses encountering connected systems at every link in the value chain", which refers to working with tools and practices based on information and communication technology. Industries such as automotive, aerospace and ship building have gone through radical changes and moved forward into digitalisation. However, the construction industry is still lagging behind in terms of efficiency, collaboration and standardisation, which could assist a digital transformation. A study conducted by the National Institute of Standards and Technology (NIST) (2004) states that fragmentation of the industry, interoperability and lack of interconnectivity are causes of poor productivity. Therefore, to reshape the construction industry, new ways of thinking and working need be introduced through the adaptation of digital methods all along the value chain. Conversely, Ramey (2012) argues that technological development can increase social isolation by people spending more time alone, learning these new technologies and using social networks to communicate. Nevertheless, applying these new technologies could help the construction industry to mitigate delays, enhance building quality, utilise resources better and improve safety, working conditions, and environmental capability.

BIM is a part of this digitalisation and is defined as a "... collaborative way of working underpinned by the digital technologies which unlock more efficient methods of designing, creating and maintaining the assets" (HM Government, 2012, p.3). In this definition, collaboration is the involvement of two or more individuals in a joint venture, typically one of an intellectual nature in which participants willingly participate in planning and decision making (Henneman *et al*, 1995). Moreover, these digital technologies within the BIM process

are sufficiently capable of changing the way of working in order to manage processes within the construction industry with the aid of structured 3D models and enriched data using an array of interoperable technologies. Digital technologies are a set of electronic tools, systems, devices and resources that help to generate and store data and their interoperable attribute helps to exchange these collected data in a usable way. Therefore, the idea of introducing BIM into construction projects helps the industry to move towards digitalisation and also to achieve advances in improving productivity and efficiency.

1.1 Building Information Modelling (BIM)

In this digitally transformed construction world, the utilisation of digital technology is vital to satisfy increasing client expectations in terms of quality, efficiencies, engagement, certainty and risk reduction. BIM plays an important role in this transformation of pushing the construction industry towards digitalisation by using models and multi-disciplinary integration in construction projects. Therefore, several countries have started to adopt BIM into their construction projects, with the United Kingdom (UK) being one of them. The UK Government has mandated collaborative 3D BIM for supply chain members throughout the whole project lifecycle (Cabinet Office, 2011). 3D BIM involves maintaining all project and asset information, data and documentation in electronic formats. In the construction industry BIM can be used throughout the project life cycle by clients to define their project needs; by design teams to analyse, design and develop projects; by contractors to manage construction; and by facility managers to operate and maintain buildings (Grilo and Jardim-Goncalves, 2010). In addition, BIM implementation is expected to eliminate waste, increase feedback, delay decisions in order to achieve consensus, deliver fast, built-in integrity, empower teams, and to control the whole construction process (Arayici *et al*, 2011). Even though BIM has the potential to tackle a number of challenges in the construction industry, its implementation has been slower than expected due to various barriers. A lack of skilled people who can work with BIM in the construction industry is one of the major threats to implementing BIM in construction projects (CIOB, 2013; NBS, 2016). Therefore, adopting a new learning approach is vital to develop skills to handle this shift towards digitalisation to access relevant, robust learning and to make connection between existing learning.

1.2 What is connectivism?

Connectivism is new digital age learning, as conceptualised by Siemens and Downes (2009), and concerns social learning that is networked. This defines how learning happens in a rapidly changing digital world. According to connectivism, learning is not only the accumulation of knowledge instead it is about finding what is needed and meaningfully connecting them to the relevant components such as information, idea and people (nodes). The idea behind this is to observe the structure of knowledge as a network, and learning as a process of pattern recognition. This is vital to use and for the application of digital technologies to improve the construction process. The relationship between work experience, learning and knowledge is at the center of connectivism. Application of connectivism in construction projects can help people to learn effectively and accelerate the construction process by connecting the different stakeholders within the project. This does not mean that everyone in the project should know everything; instead, project team members should know where to access knowledge and information when they need support. Learning is efficient when the connections are maintained well in a system during the digital transformation. Therefore, people need to be able to make

connections between concepts and information which are current and accurate. This study uses connectivism to identify the learning aspects that influence BIM construction projects and to understand how learning can take place in digitally-enabled projects.

Connectivism is a learning theory that focuses on complex learning in a rapidly changing digital world. It is a combination of principles explored by chaos, network, complexity and self-organising theories. Chaos theory describes how unrelated events may seem, when studied together, to create a pattern that can show relevance beyond the individual events themselves (Salmon, 1999). Subsequently, Siemens (2005) suggests that people can no longer experience everything by themselves alone when they are trying to learn something new. Therefore, it is essential to create a network (people, technology, social culture, and power grids) which creates connections for sharing ideas and knowledge within the learning environment. At the same time, systems, or environments, are complex and comprise different components. Complexity is a position that is situated between order and disorder. Consequently, overall development of the system is unpredictable and uncontrollable due to the non-linearity of interactions. Thus, systems need to be self-organised in order to produce global coordination and interaction. According to Heylighen (2008), this final structure mostly operates as a network with stabilising functions by linking the connections between the agents. Therefore, with the combination of these theories, connectivism is about self-organisation and understanding the patterns between the connections within networks in order to learn something new.

Connectivism theory describes how connections are formed in a network through entities (nodes). The starting point for learning happens when knowledge is triggered through the process of the learner connecting to, and providing information into, the learning community. This happens when individuals apply their personal knowledge to a common system and gained knowledge is then fed back into the same system. This cycle continues and the individual's knowledge keeps on growing through constant interactions with the cycle. The benefit of this is that learners can remain up-to-date on any topic through the connections created and can promote and organise the flow of knowledge to achieve common goals (Siemens, 2004). Siemens (2004) describes 'community' as a cluster of similar areas of interest that allows interacting, sharing, dialoguing and thinking together. A learning community in the connectivism model is described by nodes which are part of a larger network (Downes, 2007). A node could be anything that can be connected to another node, such as organisations, groups, communities, fields, ideas, information/data and emotions.

1.2.1 Characteristics of connectivism

Connectivism considers learning as a process of creating connections between two entities and expanding the network (Siemens, 2006b). Downes (2007) states that knowledge is distributed across a network of connections and, therefore, that learning consist of the ability to construct and traverse those networks. Moreover, he describes this distributed knowledge as connective; thus a change of state in one entity can cause or result in a change of state in a second entity. According to Downes (2007), the application of connectivism has offered the insight of key characteristics, such as diversity, autonomy, openness and interactivity, as part of connective knowledge. He believes that it is essential to develop each of these aspects of connectivism for a connected way of learning.

Autonomy is about self-directed learning, which Mackness *et al* (2010) describe as “the learners’ choice of where, when, how, with whom and even what to learn” (p.4). Interactivity,

which is sometimes referred to as connectedness, is grounded in the networking aspects of connectivism and is viewed as the ability to connect with others. This connectedness principle is addressed in communities of practice (Wenger, 2000) and personal learning networks (Richardson & Mancabelli, 2011). According to Downes (2010), the principle of diversity focuses on the availability of multiple perspectives for learning. On the other hand, the principle of openness emphasises the ability and willingness to share information. Saadatmand & Kumpulainen (2014) in educational context have highlighted the importance and benefits of openness in terms of building knowledge. Even though connectivism has distinctive features, people’s view of it differs according to their standpoint.

1.2.2 Global view of connectivism

Previous learning paradigms such as behaviourism, cognitivism and constructivism discuss how people learn, as shown in Table 1.

Table 1: Different perspectives of learning

Theories	Perspectives of learning
Behaviourism	Learning as the creation of a habitual response in particular circumstances.
Cognitivism	Learning viewed as a process of inputs, managed in short-term memory, and coded for long-term recall.
Constructivism	Learning takes place with the creation and application of mental models or representations of the world.

Behaviourism and cognitivism view knowledge as external to the learner, and the learning process as the act of internalising knowledge, whereas constructivist principles state that knowledge cannot be inserted within learners and that they need to be actively engaged to create meaning from their experiences. These theories have only considered learning which takes place inside a person or group, but the situation has changed now due to digitalisation, and learning is no longer limited within certain boundaries. Instead, it is driven by the formation of connections in networks. Siemens (2004), from his intrapersonal view, argues that these earlier learning theories fail to address the learning that is located within technology and organisations. Moreover, he believes that connectivism will help to share cognitive tasks between people and technology in order to cope with technological change.

Learning, in connectivism theory, is actionable knowledge which can also exist outside people and which focuses on connecting specialised information sets. These connections enable people to learn more from the current state of knowledge (Siemens, 2004). In other words, the connectivism model of learning is no longer an internal, individualistic activity because the knowledge is distributed across networks. Moreover, connectivism works through understanding decisions which are based on rapidly changing information. This is important in the digitalising world, because a person’s working habits and functions change with the introduction of new technologies and tools. The notion of connectivism considers that overall knowledge continues to grow and evolve; however, ‘important’ or ‘valid’ knowledge is now different from prior knowledge. Therefore, people need to differentiate between important and unimportant information to make the right decisions. Furthermore, learners should have the ability to search for current information, to filter secondary and extraneous information. Moreover they should also have the right skills to apply the relevant information to achieve

their targets. According to Siemens (2008), seeing the connections between the entities in the learning environment is a core skill in the new digital age. Therefore, connectivism could be used to consider how learning happens in the digital world; however, at the same time, it also has a negative side.

Verhagen (2006) argues that connectivism is nothing more than a pedagogical view because it involves no new principles and has not explored the processes of how people learn. According to Chatti (2007), connectivism omits some concepts such as reflection, learning from failure, error detection and correction, and inquiry, which are essential for learning. Even though Kop and Hill (2008) agree that connectivism is not a separate learning theory, they argue that it shifts the control of learning from tutor to autonomous learner during the development and emergence of pedagogies. Supporting this, Ally (2007) mentions that the world has become networked and learning theories developed earlier are less relevant; however, this theory is not a standalone one for the digital age. Instead, it is a model that integrates different theories to guide the design of online learning materials. On the other Foster (2007) claims that connectivism needs to be considered as a learning theory because the limitations and full range of connections within which learning can take place are considered within the theory. Even though there is a need for further refinement of the connectivism concept, it is an appropriate and timely one in the increasingly digitalised world.

Taken together, this literature reveals there is a need for a new learning approach in construction projects during the digital transformation which is more than the acquisition of knowledge. Learning in connectivism is not only the accumulation of knowledge but also the meaningful connection between the nodes in the learning environment. Therefore, this paper seeks to identify the key aspects that emerge from the basic connectivism characteristics that are highly influential in creating a connected learning approach in BIM construction projects. This is to encourage more people to implement BIM in construction projects through mitigating the lack of skilled people and widening their existing knowledge.

2. RESEARCH METHODS

The aim of this study is to explore how connectivism helps people to learn and improve their skills in order to acquire knowledge related to digital construction during the implementation of BIM. This is achieved by actively looking for new emerging aspects from the key characteristics (autonomy, openness, connectedness and diversity) of connected learning methods. Data for the study were collected by conducting semi-structured interviews and from a case study observation. The purpose of the semi-structured interviews was to understand the significance of skills deficiencies and to obtain the in-depth experience of professionals engaged in BIM construction projects. Pre-set open ended questions were employed in the interviews to obtain a wider view of the situation, which also helped the researcher to understand the importance of learning during BIM adoption. Twenty people working in the UK construction industry in a variety of roles were interviewed, such as BIM co-ordinator, BIM manager, BIM consultant and BIM technician. All the interviewees chosen had more than 2 years' experience in BIM construction projects. The professionals interviewed were from both public and private sectors and were chosen by considering their experience and involvement with BIM-related activities in their construction projects. The interview duration was approximately 40-50 minutes. Two pilot studies were carried out before conducting these interviews, which helped to refine some of the questions and restructure the sentences. The interview questions for the study were divided into three sections to address the skills

deficiencies and the need for a new way of learning in BIM construction projects. The questions in part one were related to the interviewees' role and experience in handling and using BIM in their construction projects. The literature has explored several benefits of BIM and this section helped the researcher to understand how well construction professionals are utilising it in their construction projects. After establishing the interviewees' BIM knowledge, they were asked to relate their views and concerns about the acquisition of primary skills during the implementation of BIM in construction projects. The questions in part two were developed to address the significance of the skills deficiencies in BIM construction projects highlighted in several construction reports (CIOB, 2013; NBS, 2016). Finally in part three they were also asked to share their views on their BIM learning experience in construction projects. This was to emphasise the importance of learning to acquire knowledge and the need of new learning approach to make connections during the transition to digital construction.

A case study is "A strategy for doing research which involves an empirical investigation of a particular contemporary phenomenon within its real life context using multiple sources of evidence" (Robson, 1993, p.146). A case study approach was adopted for this study to identify the aspects of connected learning needed for the implementation of BIM projects and to understand how people learn during technological innovations. The interviews and case study approach are part of an ongoing PhD research. The chosen case study is a £31 million fully integrated BIM construction project in the UK, a 100,000 square foot extension of an educational building. The building is being constructed to provide space for 3,000 students and staff members and features 650 rooms, a student hub and lecture theatres. It also includes a new library, and teaching and IT spaces. This high-tech university project has used Level 2 BIM for its delivery and detailed planning, with completion anticipated in September 2017. The key purpose of engaging with this project was to explore what is happening in practice. Moreover, this case study exploration encouraged an in-depth investigation of skills issues and learning opportunities while working with BIM. Case study research uses multiple sources (Yin, 2003). In this research, data were gathered from interviews and by observing the project meetings held every fortnight. Notes were taken during the observation process. The purpose of choosing project meetings was to obtain a collective understanding of how the organisations interact and communicate with each other in a BIM environment. Data collected from both the semi-structured interviews and the case study were transcribed and Nvivo was used for analysis. Nvivo in this study has been employed to evaluate, interpret and to explain the social phenomena regarding "Learning in Practice" in BIM construction projects.

3. FINDINGS

The construction industry is characterised by fragmentation and structural issues. In addition, the environment in the industry is always in a state of change due to technological innovations. Currently, BIM is playing a major part in the digital transformation process. According to the literature, identifying a new way of learning is important to understand how people work and run a project smoothly during technological innovations (NIST, 2004; Siemens, 2004). As part of the wider research work, this paper seek to identify the key aspects that emerge from the basic connectivism characteristics that are highly influential in creating a connected learning approach in BIM construction projects. Based on semi-structured interviews and the case study, this study has identified the following five aspects: openness to learn, continuous learning, community of practice, interactive tasks, and discovery learning as part of creating the connected learning environment in BIM construction projects. The features identified in these five aspects confirmed that this new learning approach helps to make efficient decisions,

improve skills and to widen the existing knowledge. However, the most appropriate aspects for the learning environment depend on the situation where project activity takes place.

3.1 Openness to learn

The learning environment in construction projects often involves broken learning and feedback loops, where the architecture of the production system is always fluctuating with the changing shape of the project (Gann and Salter, 1998). Hence, there is a need for an environment which better adapts to people's needs, open to integration with any innovative technology which facilitates the integration of the tools used for project completion. Openness to learn is a valuable feature needed in construction projects because of their rapidly changing nature. From both the interviewees and the case study this feature is observed in several situations. Interviewee 11 mentioned that *“I went to a two day Revit course and watched several YouTube videos and made 100s of mistakes”*. This statement shows that people within BIM construction projects are encouraged to learn from their mistakes. The lessons learnt from these mistakes were also observed in the case study in a situation where a design clash between a radiator pipe and staircase was identified. This was caused by a BIM coordinator's mistake of not considering the half landing in the staircase. Therefore, the coordinator and architect, after trying several options in the model, decided to move the radiator pipe to the right hand side of the staircase, which provided a better route and did not clash with the staircase. In this situation, the BIM coordinator took on the ownership of his mistake and learnt to carefully analyse the specifications before modelling. Moreover, learning from this mistake has taught him what is needed and what works for the project.

In some situations, learning also took place by listening to people and accepting constructive criticism from other team members. At the end of a meeting, the architect spotted that wrong NRM codes had been provided by the other team members and guided them to look at the NRM code standards before replacing them with the correct ones. During this situation, team members in the meeting listened to the architect and accepted the constructive criticism provided on the NRM codes. Moreover, the structural engineer's and mechanical and electrical (M&E) engineer's interaction with the architect shows the openness to learn about these codes. In BIM construction projects software keeps on changing, however project team members are ready to change and learn the new programmes to use them in the project. In the case study, Naviswork was used to conduct clash detection; however, project team members had now moved to BIM 360 Glue, which is a cloud-based coordination and collaboration solution which connects the whole project team, streamlines project views and coordinates the workflows. This illustrates that project team members are open to learn new things according to project changes. In another situation in the case study during the lighting installation, it was diagnosed that the curtain wall linked to the lighting needed to be moved. During this situation, the M&E consultant, BIM coordinator, architect and structural engineer came together to discuss alternative ways to solve the issue by closely examining product details and project documents. In this way, project team members were motivated to learn from each other by asking several questions to understand the alternative ways suggested by each other. This teamwork shows that team members are open to learn and motivated to understand alternative methods to resolve problems. Project team member's openness to learn in the above situations in BIM construction projects were observed through learning from mistakes, accepting constructive criticism, being ready to change, and learning from others. Moreover, interactions with others have increased the motivation of the project team members and helped them to expand their current state of knowledge.

3.2 Continuous learning

According to Tannenbaum (1997, p.438), continuous learning is “the process by which individual or organisational learning is fostered on an ongoing basis.” Moreover, he declares that organisations can only learn when the individuals/teams employed within them are continuously learning, which also encourages the acquisition and application of new skills and ideas. BIM is a new way of working; therefore, tasks within BIM construction projects are executed differently to the traditional approaches, using advanced technologies. The interviewees highlighted that they are continuously learning to work effectively and to make right decisions in BIM construction projects. For an example Interviewee 19 stated “*I initially started learning BIM through tutorials on YouTube and read some information about how to use it and I am still learning during the construction process of the project.*” Moreover, he added that he has applied these techniques and gained knowledge to select the correct elements and procedures to create the BIM model. This illustrates that learning is not only continuous, but also helped to make connections in the project.

In the case study, the project team members were learning in multiple ways, such as observing and interacting with more experienced people at work; trying new and alternative approaches; asking for help or advice from other team members; and finding ways to improve their knowledge and skills through various learning avenues (i.e. training, seminars and self-learning). In the case study, it was found that when professionals wanted to install handrails in a building there was an issue regarding riser sizes and intrusions of steel connections. In this situation, the project team members handling this problem did not have enough skills to resolve the issue and sought more advice from other project members involved in the project. Therefore, a team member from another organisation came forward to resolve the problem using his experience. The solution to resolving this problem was explained in detail with the aid of 3D models, 2D drawings and specifications. Discussions included options for handrail installation, consideration of other building elements during installation, and different materials that can be used for handrails. Learning in this incident was gained through interacting with an expert. Furthermore, interviewees mentioned that having the right mindset is also important for continuous learning. Interviewee 5 stated that “*I think having a beginner’s mindset is beneficial.*” Also in the case study, in a meeting the architect mentioned that even though “*...there is BIM as a process, and different ways of doing things, it is important to have a beginner’s mindset.*” These characteristics of making connections, learning in multiple ways, learning from an expert and having a beginner’s mindset enable the project team members to explore the ideas further and adapt to the constantly changing environment.

3.3 Community of practice

According to Siemen (2004), learning is no longer an internal, individualistic activity because knowledge is distributed across networks. Communities of practice are groups of people who share a common vision of something they do, and learn how to do it better as they interact regularly (Wenger, 1998). A BIM learning community is formed by a group of interdisciplinary people who share common goals. However, objects within BIM projects are created and developed over time and can be viewed differently by other project team members. Therefore, a common focus is important during the working towards a common goal. In the case study, windows in upper floors were modelled with blinding. However, in a meeting the BIM coordinator suggested that windows without blinding do not make any difference. Supporting this, the quantity surveyor mentioned that it would also be cost effective for the client. After

analysing the lighting impact with and without blinding, blinding from the windows was removed in the BIM model. This shows that project team members do consider suggestions given by other team members and their acceptance indicates that they all work towards a common focus.

In another situation, a riser went higher than was designed, therefore the frame sizes and sizes of services needed to be changed and the top of the riser needed to be waterproofed. In this situation, a collaborative team including designer, contractor, sub-contractors (M&E) and suppliers (waterproofing, frames) became involved in resolving the issue. During this process, several inquiries regarding risers and their position were raised. To tackle these collective inquiries raised by the project team members, a BIM champion from the contractor's side was approached to find a solution. This person explained the procedures to fix the upstand in the front phase and top. He also indicated the places where extra steel was needed. Moreover, options to alter the frame sizes and sizes of services were also discussed with the team by referring to 2D drawings, 3D models and specifications. Teamwork in this situation provided opportunities to share and connect different ideas and knowledge to complete the task. In other words, professionals learnt different things from each other in this community. These observations show that working together with interdisciplinary teams, collective inquiries, a common focus, and collaborating within the team are needed to make effective decisions.

3.4 Interactive tasks

Interactive tasks are effective and intentionally planned instructions that make learning a shared social experience (Look, 2011). Most of the tasks in BIM construction projects are interactive, allowing project team members to learn from each other as they work collaboratively and cooperatively. In the case study, communication between the project team members took place through observation, discussion, questioning, sharing and transferring knowledge. For example, the total numbers of floor boxes including their positions were discussed. The team had initially decided to install 45 floor boxes; however, feedback from the manufacturer suggested that these could be reduced. This was because the client had not requested any power supply in some of the seated and common learning spaces. Therefore, in response, alternative ways of positioning the floor boxes were suggested by the team members. In addition, the architect also raised the question of furniture that needed some extra floor boxes, and the BIM coordinator shared additional information about data cables and highlighted the clashes with floor boxes in the meeting. These comments from peers were taken into consideration to finalise the number of floor boxes and their positions. This situation illustrates that the process of feedback and response, including peer discussion, helped in making decisions without additional cost.

In another situation, an issue regarding the doors that went into the vent riser was raised. This was due to uncertainty over the number of doors marked in the setting out. The project team analysed the number of doors in the model and started commenting on their position. During this process, the quantity surveyor also explained the door details to the M&E engineer with 2D drawings and highlighted the door that went into the riser. After understanding the problem, the M&E engineer became involved in the discussion by commenting on the door position (i.e. he mentioned that a duct ran near the door and needed to be considered when altering the door position). After communicating with each other, the team members came to the conclusion to revise the door schedule and its position. In this situation, the peer support provided by the quantity surveyor helped the M&E engineer to understand the issue rose in the meeting. During

these situations, interactive tasks in the BIM construction project allowed the project team members to stay connected with the task and motivated their involvement in the BIM project. From the above discussion, it is evident that team members' knowledge was widened through the features of feedback and response, peer support and communication within the team.

3.5 Discovery learning

According to Bruner (1961), discovery learning is an inquiry-based, constructivist learning approach that takes place in problem solving situations where the learner draws on his or her own past experience and existing knowledge to discover facts and relationships and to learn new truths. During the clash detection process in the case study, a concrete upstand clashing with the surface was highlighted by the BIM coordinator. Inquiries regarding the landscape were raised by the architect; however, from his experience, he suggested that additional paving was needed in this situation. Therefore, the team explored the issue by reviewing the perimeter all the way through the landscape area and suggested that the thickness of the concrete upstand needed to be reduced to avoid clashes with the surface and agreed to add the additional paving suggested by the architect. This experience, shared by the architect with the project team members, helped to avoid further clashes and to make decisions.

In another situation, a new ceiling which had been added was clashing with the lighting. The architect and the building service engineer explored different ways of moving the ceiling and lighting. While this exploration was taking place, the architect also realised that the pipes into the risers also needed to be taken into consideration when moving the ceiling and lighting. After analysing alternative ways, the problem was resolved by deciding to slightly lift the ceiling upwards (at the top of the staircase), after the building service engineer had moved the lighting. In this situation, a constructivist view was observed, whereby the problem was resolved by both the architect and building service engineer understanding each other's ideas and experiences. Moreover, this also helped the architect to focus on other related elements such as pipes when making alterations to the ceiling and lighting. Features such as inquiry-based learning, sharing experiences, exploration and problem solving in the above situations promoted active engagement and helped the project team members to build on their prior knowledge and understanding.

This study has explored the aspects that are essential for a learning approach to a BIM construction project. Currently, technology is rapidly evolving, while the construction industry is trying to enter a digitalisation mode. To create a connected learning environment, a new learning approach including the discussed aspects is needed in the new digital age. Moreover, in this ever-changing world, continuously evolving learning is required to address the changes and to connect with other nodes in the learning environment to identify patterns, to learn and to make decisions. Thus, stakeholders in BIM construction projects need to view their environment from learning ecological concepts to cope with the rapidly changing digital environment.

4. CONCLUSIONS

Digitalisation of the construction industry has been expedited by the introduction of BIM. However, BIM adoption is slower than expected due to the lack of skilled people to work with it. Hence, to overcome this, project team members need to recognise the interconnections and

understand the patterns of connections within the learning environment to improve their learning in practice in the new digital age. The connectivist viewpoint can be used to understand this new way of learning in a digitally enabled environment. This new learning approach views learning as actionable knowledge and considers the learning that exists outside people, which focuses on connecting specialised information sets. However, the aspects which were identified in the study as part of this new learning approach, namely openness to learn, continuous learning, communities of practice, interactive tasks and discovery learning, also need to be recognised in order to understand the connections and relationships that exist in the learning environment. Thus, to move towards digitalisation through implementing BIM, and to learn in this environment, stakeholders need to see the world in a connected way (i.e. the connectivism concept) and should attempt to create an ecological system for learning that allows people to continuously learn to cope with the rapidly changing digital environment. This study is part of a PhD research which will continue to explore how project team members can create a Learning Ecology within the work environment in practice to address BIM challenges.

5. REFERENCES

- Ally, M., 2007, *Foundations for educational theory for online learning*. In T. Anderson and F. Elloumi (Eds.), *The theory and practice of online learning*, Edmonton, AB: Athabasca University Press, pp.15-44.
- Arayici, Y., Coates, P., Koskela, L., Kagioglou, M., Usher, C. and O'Reilly, K., 2011, BIM adoption and implementation for architectural practices, *Structural Survey*, 29 (1), pp.7-25.
- Berger, R., 2016, *Digitization in the construction industry*, Munich, Germany, Roland Berger GMBH.
- Bruner, J. S., 1961, *The act of discovery*, Harvard Educational Review, 31, pp.21-32.
- Cabinet Office., 2011, *Government Construction Strategy: One year on and Action Plan Update*, Available: <https://www.gov.uk/government/publications/government-construction-strategy>. Last accessed 2nd March 2017.
- Chatti, M. A., Jarke, M. and Frosch-Wilke, D., 2007, The future of e-learning: a shift to knowledge networking and social software, *International Journal of Knowledge and Learning*, 4(5), pp.404-420.
- The Chartered Institute of Building (CIOB)., 2013, *A report exploring Skills in the UK Construction Industry*, CIOB: Berkshire.
- Downes, S., 2007, *What connectivism is*, Available online: <http://halfanhour.blogspot.com/2007/02/what-connectivism-is.html>. Last accessed 1st March 2017.
- Downes, S. 2010, *Half an hour: What is democracy in education*. Available online: <http://halfanhour.blogspot.com/2010/10/what-is-democracy-in-education.htm>. Last accessed 21st March 2017
- Forster, T., 2007, Msg. 14, Re: *What Connectivism Is*. online Connectivism Conference: University of Manitoba. Available online:<http://ltc.umanitoba.ca/moodle/mod/forum/discuss.php?d=12>. Last accessed 2nd January 2017.
- Gann, D. and Salter, A., 1998, Learning and innovation management in project-based, service-enhanced firms, *International Journal of Innovation Management*, 2 (4), pp.431-454.
- Grilo, A. and Jardim-Goncalves, R., 2010, Value proposition on interoperability of BIM and collaborative working environments, *Automation in Construction*, 19 (5), pp.522-530.
- Henneman, E.A., Lee, J.L. and Cohen J.I. 1995, Collaboration: a concept analysis, *Journal of Advanced Nursing*, 21, pp.103-9
- Heylighen, F., 2008, *Complexity and self-organization*. Encyclopedia of Library and Information Sciences, Available online: <http://pespmc1.vub.ac.be/Papers/ELIS-complexity.pdf>. Last accessed 19th February 2017.
- HM Government., 2012, *Industrial strategy: government and industry in partnership*, Building Information Modelling, Available online: https://www.gov.uk/government/uploads/system/uploads/attachment_data/file/34710/12-1327-building-information-modelling.pdf. Last accessed 10th February 2017.
- Kop, R. and Hill, A., 2008, Connectivism: Learning theory of the future or vestige of the past, *International Review of Research in Open and Distance Learning*. Available online: <http://www.irrodl.org/index.php/irrodl/article/view/523>. Last accessed 1st February 2017.
- Look, S, M., 2011, *Interactive Tasks*. Available online: http://prel.org/wp-content/uploads/2014/06/Interactive_EIS.pdf. Last accessed 18th April 2017.
- Mackness, J., Mak, S., and Williams, R. 2010, The ideals and reality of participating in a

- mooc. In *Networked Learning Conference* (pp. 266–275). Available online: <http://eprints.port.ac.uk/5605/>. Last accessed 18th April 2017.
- National Building Specification (NBS), 2016, *National BIM Report 2016*, RIBA Enterprises Ltd, London.
- NIST (National Institute of Standards and Technology), 2004, *Cost Analysis of Inadequate Interoperability in the U.S. Capital Facilities Industry*, NIST GCR 04-867, Gaithersburg, Md.: NIST.
- Ramey, K., 2012, *Modern technology advantages and disadvantages*. Available online: <http://www.useoftechnology.com/modern-technology-advantages-disadvantages/>. Last accessed 12th February 2017.
- Richardson, W. and Mancabelli, R. 2011, *Personal learning networks: Using the power of connections to transform education*. Bloomington, IN: Solution Tree Press.
- Robson, C., 1993, *Real World Research: A Resource for Social Scientists and Practitioners-Researchers*, Oxford, UK: Blackwell
- Saadatmand, M. and Kumpulainen, K. 2014. Participants' perceptions of learning and networking in connectivist MOOCs. *Journal of Online Learning & Teaching*, 10(1), pp.16–30.
- Salmon, V., 1999, *Chaos in the composition classroom: Why do some classes fail to function?*, Available online: <http://www.vccaedu.org/inquiry/inquiry-fall99/i-42-salmon.html>. Last accessed 21st January 2017.
- Siemens, G., 2004, *Connectivism: A Learning Theory for the Digital Age*, Available online: <http://www.elearnspace.org/Articles/connectivism.htm>. Last accessed 1st March 2017.
- Siemens, G., 2005, Connectivism: A learning theory for the digital age, *International Journal of Instructional Technology & Distance Learning*, Available: http://www.itdl.org/Journal/Jan_05/article01.htm, Last accessed 2nd of February 2017.
- Siemens, G. 2006a. *Knowing knowledge*. *KnowingKnowledge.com Electronic book*. www.knowingknowledge.com. Last accessed 19th March 2017.
- Siemens, G., 2006b, *Connectivism: Learning theory or pastime of the self-amused?* Elearnspace blog, Available online: http://www.elearnspace.org/Articles/connectivism_self-amused.htm. Last accessed 18th March 2017.
- Siemens, G. 2008. About: Description of connectivism. *Connectivism: A learning theory for today's learner*, Available online: <http://www.connectivism.ca/about.html>, Last accessed 21st of February 2017.
- Siemens, G. and Downs, S., 2009, Elearnspace. Available online: <http://www.elearnspace.org/blog>. Last accessed 1st February 2017.
- Tannenbaum, S., 1997, Enhancing continuous learning: diagnostic findings from multiple companies, *Human Resource Management*, 36(4), pp.437-452.
- Verhagen, P. 2006, *Connectivism: a new learning theory?*, Available online: <http://www.surfspace.nl/nl/Redactieomgeving/Publicaties/Documents/Connectivism%20a%20new%20theory.pdf>. Last accessed 20th January 2017.
- Wenger, E., 1998, *Communities of practice: learning, meaning, and identity*, New York, USA: Cambridge University Press.
- Yin, R. K., 2003, *Case study research: Design and methods*, 3rd (Edn), Thousand Oaks, CA: Sage.

PROCESS OF RESEARCH AND EDUCATION FOR A CHARMING 'EUPHONY' OF SIGNS IN BUILT ENVIRONMENT DESIGN

F.G.S. Giucastro¹

¹ SDS School of Architecture of Siracusa, University of Catania, Piazza F. di Svevia, 1, 96100, Italy

Email: fablogiu@gmail.com

Abstract: The continuous changes in contemporary landscape jeopardized the existence of material signs, the result of the local culture, made up of architectural elements and construction practices linked to tradition. Their abandonment has determined their inevitable decline and a flattening of the build quality due, consequentially, to a sterile homologation of techniques and materials complying with local requirements. Hence, it comes the necessity of studying the sites in their specificity and uniqueness in the world, and try to understand the difference between them from each other. Every single place was determined in its specific identity characteristics, because successful match between the natural environment and human work. The report of the architectural archetypes in the Mediterranean area has aimed to put into a system, an abacus, the technical and formal characteristics for the environment and the typical architectural elements, which today form the image of the landscape. The aim of the research was to arrive to some proposals for the preservation of the territory, which, not wanting to limit itself to the negation of necessary processes of transformation, can provide, through the study of the characters and invariants of the built, indications for its conservation and enhancement.

Keywords: Abacus, Built Environment, Education, Euphony, Invariants

1. INTRODUCTION

The unit of research of the School of Architecture in Syracuse, coordinated by Prof. Truppi, Professor of Environmental Design, coordinated the research teams of six faculties in Italy, to address the issue of the promotion and defense of the environment; research financed by the Italian Ministry of Education and Research. This paper is an extract of the work of my research group, representing educational material for our courses of the School of Architecture in Syracuse.

The continuous changes in contemporary landscape jeopardized the existence of material signs, the result of the local culture, made up of architectural elements and construction practices linked to the tradition. Their abandonment has determined their inevitable decline and a flattening of the build quality due, consequentially, to a sterile homologation of techniques and materials not complying with the local resources.

Hence, it comes the necessity of studying the sites in their specificity and uniqueness in the world, and try to understand the difference between them from each other. Every single place has been determined in its specific identity characteristics, because successful match between the natural environment and human work. This meeting is combined so that generates historical elements that are not repeatable in the adjacent territory.

The main purpose is to create a living environment designed to meet the changing demands of man and to adapt them to the relative environmental changes, through the use of flexible systems, reversible and environmental friendly, by building upon available resources. The following aspects have been analysed in some identified areas of the Mediterranean landscape, they are above all the historical-cultural values and the invariants of the built environment.

The objective of the research lies in the proposal of an active conservation of the territory that, not wanting to be limited to the denial of processes of necessary transformations, can provide indications to the protection, development and enhancement of all that, today, is still existing. To refer to the memory as research for an identity, the progressive conquest of belonging. When one speaks about memory, it is not just referred to the evocative ability of the past, but to the influence it exerts on the present and which defines an effect for the future.

To achieve these goals, it is necessary to know and deepen the state of the places, characterized by an expertise of 'practices and signs' both from the physical-spatial point of view and from the morphological-landscaping that one. The valorisation of the landscape requires a process of revision of the design, aware of a reality in continuous transformation, to ensure the organic integration of architecture into the territory.

The research investigated innovative relationships between strategies for improving the quality of life and the continuity of environmental systems in the transformation of the built environment. For a new definition of the methodologies and operational tools to defend the landscape, the main theme addressed by the Seven Local Units of Research is a broader interpretation of the 'process of transformation of the territory'.

2. UNITS OF RESEARCH AND OBJECTIVES

In the field of the research on the aspects of the natural landscape, the units have dealt with the relationships:

- between built and coastal landscape, in the dynamics of environmental risks;
- between natural resources and energy production systems from renewable natural sources.

Within the urban landscape, they investigated the reports:

- between archetypes and forms of urban settlement, in the continuous and different adaptation of materials and techniques to the forms of the natural landscape;
- between architectures of waste and urban waste, in the investigation of the settlement and design logic of production complexes and conversion criteria, in the recycling process between differentiated accumulation and the transformation of the resources of secondary raw materials.

In detail, the SDS School of Architecture of Syracuse, as the coordinator of the project, has taken on the task of investigating conceptual models and translating them into methodological aspects, assimilating the results of specific surveys of the individual other units. Reading the nature of the landscape through archetypes traces; a path that, starting from radical and eternal figures, characterizes and enhances the environment, pointing to exemplary models to operate. These figures, thanks to which the environment takes on identity, offer directions to explore, to heal the damage of the place and regain its beauty.

The research group at the University of Genoa examined the characters derived from the relationships between built and coastal landscape. The research has elaborated a process of analysis and evaluation to support the territory project, interpreting the protection of goods and reducing risk as opportunities to 'produce new beauty and economy'. It has taken as a case study a stretch of the Ligurian Riviera, where there are numerous environmental and cultural values, as well as the risks (erosion, droughts, floods, etc.). Using open source GIS systems, it was possible to build 'Atlantic assets', define the regulatory framework and planning, identify and locate risks and weaknesses, to make comparisons and assessments across the stairs.

The studies conducted by the Polytechnic of Milan investigate the different approaches to the project and the definition of the renewable energy system in the landscape, overcoming the preconception that it becomes an element of disturbance of aesthetic and social equilibrium, to conceive it as an opportunity and potentiality to create shared multifunctional energy landscapes at different scales. The research has developed analytical and instrumental results: the rebuilding of a cognitive framework of recent energy landscapes, which tracks the development and innovation of energy systems in relation to the landscape, the production of an unprecedented meta-design support to govern complexity of relationships between energy systems and landscapes, defining interventions and rules. Experimenting with this tool in a district in the Milan area has triggered relations with local authorities, opening up further consultancy collaborations for the research development.

Within the urban landscape, the unit of the University of Naples 'Federico II' has investigated the relationship between the transformation of the settlement and the quality of life, in the continuous and different ways of adapting to the forms of the social landscape. From the definition of UNESCO's Historic Urban Landscape (HUL), the research analysed the concept of landscape by explaining approaches to active protection, such as evaluation, programming and control, based on the logic of shared responsibility between users and managers. The interaction between evaluation, planning, recovery and maintenance skills has allowed to expose interdisciplinary reading, interpreting the landscape as a complex indicator of health, quality of life and well-being, with particular attention to the 'Pompeii system', from the Metropolitan City of Naples, to the buffer zone of Pompeii, to the district of Torre Annunziata.

The research group at the University of Palermo has designed scenarios for the circular management 'resources-waste-resources' of the city, starting from the connotating elements of the urban systems in exemplary samples, for characteristics of reproducibility and repeatability. For this short-range circularity, the assumptions are the pre-treatment of waste to anticipate the way to the resource, starting from residential units. The mutuality between historic town and perimeter bands of residential-commercial or agricultural production in a scenario of synergy between the parts; the breakdown of the City into districts; the functionality as a network of small centres to explore economies of scale in the management of the services.

The Second University of Naples has identified elements of connection of the built environment, contracted with natural components, light, air, sea water, green intervention ideally connected to the natural scenery. The case study, the intervention of Municipio Square in Naples, shows an attitude of 'humility' towards the historical pre-existence by the designers, led by A. Siza and E. Souto de Moura: the design choices were given by an evolutionary relationship made for progressive adjustments due to historical stratigraphy discoveries.

UniNettuno has defined processes of analysis of urban landscapes, highlighting the role of the representation as a reading and control instrument of transformations. The case of the Jewish Ghetto of Rome, a tangible memory of the Jewish community in the historic city, has returned pieces of evolved cities for subsequent stratifications. The research for balance between identity and new needs has transformed the site from introverted conclave to an osmosis body with the outside, an expression of contemporary social dynamics, which reversed the relationship between living and productive function. Archetypal interpretations, so articulated between themes and concrete cases, returns a lesson about the potentiality of the research, indicating an attitude to apply in other contextual situations, for a connection with the pre-existing, in a strategy that can reconnect with force natural elements and human transformations.

3. THEMATIC AMBIT AND METHODOLOGICAL APPROACH

3.1 Environmental system

'The environment is all that exists around us and it constitutes the complex of the material and cultural conditions of our life'. (Truppi, 2006)

The activities that the Research Unit of the University of Catania performed are aimed to define a methodology to identify strategies for landscape management compatible with its system of values. This methodology will allow the implementing of a project of knowledge appropriate to the complexity of the landscape and the development of assessment tools, able to direct actions for the management of local conflicts.

The complex nature of the landscape requires a discretization of the phenomena that characterize these characters, outlining themes and disciplinary cuts aimed at overcoming erroneous interpretations and risky omissions. The beauty of the nature is the product of the intelligence of thought and of human work over the course of several ages: it is a huge book, a palimpsest in which thousands of years of history are written, characterized by mobile elements, especially people and its activities, and fixed physical elements. We are not just witnesses to this show, but we are interpreters of it, we are on stage with other actors (Lynch, 1964). The environment is a unitary and self-made object, albeit very diverse and complex. A diverse set of closely related phenomena and functions and related transformations, in which each element has a precise role, just like in a living organism whose parts interact according to precise laws.

The objective and synthetic observation of the environment is therefore the first thing to do to understand what, by decomposing and analysing, risks not to appear anymore with its fundamental character of organismic unity. The environment is therefore a reality and it is also a process of perpetual transformation, an infinite becoming, and the temporal fraction that we can conjure in our observations is nothing but the result of all the mutations that have occurred so far and at the same time, the premise of the mutations that will follow in time.

Part of it, moreover, is the fruit of the spontaneous evolution of the nature; it is still the effect of the changes made by man's hand on it to adapt it to its material and spiritual needs. It is consequential to compare the environment to a palimpsest because, in fact, the environment, natural or anthropized, is the stratified sum of all the setups and configurations it has taken over the past epochs. Where it has not, progressively, erased itself, as it naturally tends to do, the testimonies, the traces, the signs of a remote past remained. Ancient artifacts, roads, canals, farms, margins, millennia trees, plant species and everything that, telling the past explain the present as the last, the most recent 'building', built on the ruins of thousands of buildings or of the past. All that we see by observing an environment is nothing more than a single frame of an exaggerated film flowing for millions of years. We can calculate how much of this movie has already passed, while it is impossible to know how much remains to be seen. Our experience, though dilated for a few decades, can only capture a short excerpt of this movie, just a few scenes, even if for many aspects it has already enabled us to notice how it is a succession of different scenes, of moving images, of slow or extremely fast sequences: a 'story' with a multitude of protagonists, all of them linked in the same story.

Each contest has its own long-lasting design, distinctive characters, identifiable and perceivable shapes; all this contributes to define its identity, intangible characters, unsurpassed thresholds

for compatibility of the modifications. The context analysed is a place where artifacts of very high historical and architectural value come up, such as villas, rural houses, farmsteads, towers, churches, colonial houses and the orchestration of these units, which weaves a dense and vivid image that supports it, is just the texture, the palimpsest, the plot, the architecture. That is not only made of settlements such as villas, houses and churches, but it is also made of paths, margins, neighbourhoods, knots and references interacting in a unit, due to the many hundreds of twisted signs that a millennial society has produced throughout the history between stone culverts, opened windows on the landscape, presences marking and portraying the territory.

The housing features, also referred to the materials, the presence of collective memory, the courtyards, the terraces, the hills, waterways, architectural emergencies, barriers and filters. Thus, the palimpsest of the examined territory is an architectural construction made up of ‘a system of signs and practices’ (Truppi, 2004) of types, exemplary models, modes of execution, variations that over the time have produced architecture, a place characterized by identity characters, sometimes obvious, often hidden or threatened, which constitute the invariants to be consolidated and valorised.

The uniqueness that each context has acquired is in fact an expression of a pragmatic spirit, of a construction process, of manufacturing that has involved the creative activity of men who have lived and acted in the experience and action.

3.2 Archetypes, identity and invariant characters

The research pursues the different forms of the archetypal concept, intercepted in natural and anthropic landscapes, by analysing those circular processes that aim, through the recovery of that is existing, to outline management strategies for future transformations. For this reason, the archetype has been grasped in its essential characters, guaranteeing its recognition even in culturally different contexts and in its permanent or transient nature, a product of transformation or discard to be recovered. The use of certain forms and materials allows the landscape, urban and natural, to continue to be interpreted by referring to ‘archetypes’, a reference that allows to communicate symbolic meanings through forms and constructive materials and techniques decodifiable and shared from the community.

The current reproduction of traditional materials has to re-absorb those inescapably technical and formal symbolic contents that are still rooted in our culture through archetypes. Their loss can lead to the current discomfort of the project work, now torn by the cultural context, which can not renew and reinterpret the bond with its history and is losing its characteristics of collective act immersed in a cultural tradition that can not be reduced to the present alone.

The archetypal concept can provide new insights to reinterpret the development of dialectical concept tradition/innovation in architecture. If using shared elements is a prerequisite for the recognizability of the built environment by the users, the link with tradition can become a limit if we renounce to reinterpret it or to deal with it. The archetypes represent an ideal form of architecture, an ancient architecture of the mind whose essence lies in an aura that, even technically accomplished, concretely visible and perfectly constructed, is conceptually allusive, meaningfully symbolic (Truppi, 2012).

The use of the archetype term in the art derives from the Jungian hypothesis (1943) to indicate the ‘primordial images’ that determine the typical constant forms in which it is represented

from the individual experience and images that express a primitive form of architecture based on its constructive form and / or technique, emphasizing, therefore, the permanence of elements or organisms over the time. Although through operations of alteration, these represent the characters of stability and firmness and allow to find an architecture that has ever existed.

From the study of artefacts emerge authentic proofs of the built reality of each culture, it is derived a documentation of archive, a 'not-written manual' capable of speaking and revealing authentic meanings, an autochthon culture, referring to groups and organised communities, which took place through an intrinsic and often latent process, which coincided with the progressive development of a 'model' to refer broadly to the components that had generated it. This model can be considered the expression of a society that draws on its specific heritage of cultural references, material resources, and technological capabilities, and adapts continuously to its needs the identified environment as its own historical residence and vital life sphere.

The report of the architectural archetypes in the area of research has aimed to put into a system the technical and formal characteristics for the environment and the typical architectural landscape of the territory. The constructive invariants, that are not timeless axioms, absolute truths, but stages characterized by precise experiences, (Zevi, 1973) the persistence and long-term processes, shifting attention from all that rapidly changes over the time to that remains in the territory and gives stability to relationships between man and his environment.

3.3 Stages of the research

The research has been divided into five phases.

Phase 1: Definition of the state of the art:

- A. Italian and international research.
- B. Selection and analysis of prescriptions and guidelines.
- C. National and local framework of policies and programs for protection, development and enhancement.

Phase 2: Analysis of case studies

A. Preliminary investigations on the case study:

Through the empirical observation and the collection of graphic and photographic material of a representative sample of typical buildings disseminated in the territory, physical, social and economic components have been analysed, in order to define the current site conditions and the dynamics of development. The survey is designed to provide information on the components of the natural landscape (areas with natural vegetation, rivers, quagmires, coasts, etc.) and anthropogenic components (urban areas, archaeological sites, infrastructures, manufacturing settlements, crops, c, etc.).

B. Resource location and investigation of current dynamics of development:

This system is based on surveying cards able to return the information needed to define the character of the landscape and the environmental, perceptual cultural, morphological dimensional and material constructive.

Phase 3: Guidelines for the definition of strategies for active protection.

Completed and systematized, as a first approximation, the research aims to delineate ways to integration of levels and areas of knowledge acquired.

The phase has been implemented through the following actions:

- A. Definition of conflicts (preservation/transformation)

- B. Integration of production/social components compared to the landscape's values
- C. Project priorities in a vision of active protection (eg. energy, tourism, landscape attractor)

Phase 4: Definition of strategies:

A. Definition of innovative strategies for the enhancement:

Development of programs for the reuse and redevelopment of the architectural and archaeological heritage, through the selection of resources.

B. Development/selection of evaluation tools

Phase 5: Check of enhancement strategy and of tools for the decision making:

A. Check of the evaluation results.

The verification of the correspondence between the evaluation results and local needs has been conducted through the creation of forums, with the direct involvement of local communities. The Research team will illustrate the preferable enhancement strategy to representatives of the cultural, social and productive components, in order to ensure its consistency with local requirements and to detect possible problems.

B. Assess of repeatability of the management model.

This activity aims to verify the possibility of applying the decision-making model to other urban settlements and of defining any necessary corrections.

C. Review of the methodology developed.

The methodology developed will be reviewed, on the basis of the problems found through the verification of consistency with local requirements and through the test of repeatability of the decision model.

4. TYPOLOGICAL READING AND ABACUS OF THE CHARACTERS

Within the steps outlined in the previous paragraph, my research has been developed on the phase of analysis related to the typological reading of the architectural presences in the studied territory. The abacus of constructive modalities, archetypes, which records and transcribes technical knowledge can be a useful tool for industry professionals to make evaluable choices by the point of view of the project of valorisation. To this end, the abacus of invariants highlights the relationship of reciprocity between techniques and forms, the characteristics that make the shape of the built. The abacus provides the framework of the fundamental aggregative, dimensional and material relationships in relation to the constructive problems, according to the constitutive technical elements.

This methodological approach, as well as contributing to the knowledge of the typologies and the modes of implementation, allows to develop conforming solutions, generating a proposal of orientation of the new design interventions through the suggestions present in the architectural structure of the existing and evidenced by the study of the historical processes, with a view to the progressive transformation of the built space.

It is therefore the reading phase that involves the analysis and decoding of the constructive features, also considering the stratification produced by the evolution and the transformation that the organisms have recorded in the development of their training process by introducing the material culture of specific homogeneous contexts, as expressed by a syntax based both on constructive techniques and procedures, and on distributive and formal implications deriving from the use of local materials.

Knowledge of the techniques of building of the masonries, roofs, staircases and all building components allows to define a set of criteria to be followed in interventions aimed at restoring and improving performance levels. In the relationship between form and construction there is the conceptual and technical knot of conservation and enhancement of existing building heritage. Constructions of aggregate blocks, in the shape of L, C, or at court, represent different combinations that highlight the complex relationships between the typology and the morphology of the territory.

These tools of analysis and synthesis produce the first elements for the development of a repertoire, open and up-to-date over the time, of constructive techniques related to the analysed scope, repertoire that, in addition to providing useful practical documentation for a better knowledge of the site, allows an exact reading of the material culture, suggests ideas for the project. Components of constructive equipment, understood as documents handed down from history, that give information not only about the aims of the architectural organism but also about how it was built. The list of constructive archetypes includes about fifty elements, which summarize, through a synthetic reading, the culture of the territory.

Androns, arches, balconies, stands, chimneys, bell-towers, cantons, houses on rock and water, castles, churches, courts, domes, facade elements, wells, lighthouses, openings (doors and windows), fountains, gardens, structural materials, markets, squares, bridges, city gates, porches, stairs, temples, terraces, roofs, tombs, towers, archaeological sites, types of houses are some of the elements investigated and traced in the built and the natural environment such as canals, coastal stretches, rivers, springs and water springs, waterfronts, peaks and valleys, harbours, trails.

In the varied landscape of the characteristic elements of the environment, the most important role is the construction's equipment of the different types of buildings characterized by a stone-walled and intermediate horizontal and horizontal enclosures consisting in pitched roof with sloping wooden. In the masonry, the outer fins, often in the facade, are of the type of trimmed bushes and squared bushes.

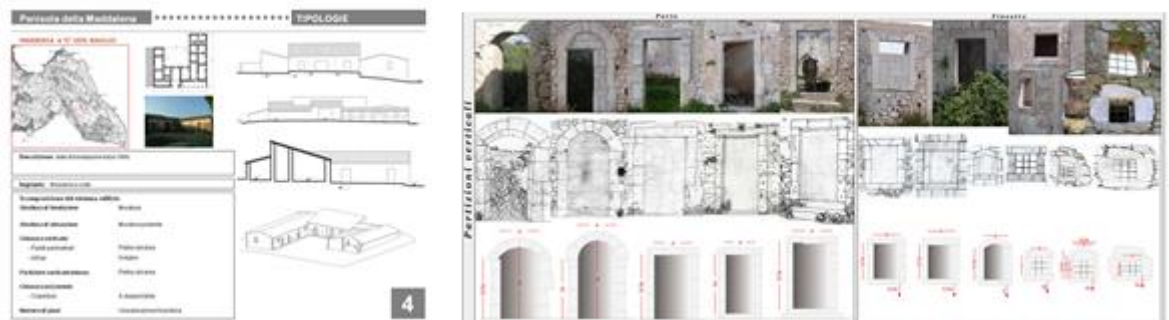

Figure 1: Example of sheet for a courtyard house in shape of C and an example of abacus for the openings

The admixture between orthogonal walls is carried out through the ‘cantonalis’ in large size squares, containing two or three rows of masonry stones. Outside, the delimitation of the slots is obtained by inserting of a frame that appears to be put into operation in conjunction with the construction of the wall septum. The simplest and most common cases are those in which the exterior exhibitions of doors and windows are formed of squared and honed stone, monolithic or multilayer stone, and wooden or stone architraves. The arc, within the vertical closures, is also sometimes discharged from the weight of the masonry overlying the insertion of wooden

beams that lead to the transmission system of the loads to that of the trilit. The horizontal closures are mainly made up of simple wrought-iron planks with partitioning boards and double-beamed ceilings of beams.

On the roofs, the most prevalent construction types are non-pushing roofs with plain wrought-iron laths with flat and double warp scaffolding and cladding with planks or slabs, which support a curved brick roof covering made of the typical tiled.

5. ANALOGIES AND CASE STUDIES

To identify those contents, foundations and archetypes, which are at the origin of ideational processes - which have more to do with interest in the repetition of things, habits and similarities, conceptual references, the association of worlds far away traditions rather than inventive ideas out of history and time - which tend to come from these new creative abilities, renewed ways of adapting to the present conditions of society and of the time.

A similar process was adopted by J. Stirling in his design. During the International Architecture Congress in Iran, in 1974, Stirling exhibited, comparing them, the past architecture with his own, pointing out as the first ones were taken as a model, by grasping the roots of his style, he shows that the archetype is enriched with so many new elements as to have so radical changes that it does not make it formally recognizable. Even though its intent is to make it recognizable the relation in material, constructive method and formal composition in order to make it born one from the other, but in a new and current form.

The environmental area of research is part of the Mediterranean region, whose climatic features have had a great impact on spontaneous local construction, especially with reference to its relationship with the construction technology of the building envelope.

The Mediterranean identity culture, result of traditional architectural knowledge, finds in the vernacular house a symbiotic relationship between the built and natural environment and the attitude of respect to its ground, making this architecture spontaneous, or mature in the getting the best result with the available material resources. A relationship that is explicitly expressed in the proper use of local materials and in the definition of norms, types and forms, which, over time, reach a certain balance with the place.

Architectural elements, born to fulfil purely functional needs, have over the time reached their connotation, transforming themselves into a patrimony of forms. To better understand the properties of modern building envelopes, it is necessary to preliminarily analyse the properties of traditional envelopes. Studying the signs of the traditional house in its forms, sizes, eaves, placements do not undergo the rules of a free formality, but they are dictated by ventilation and natural lighting requirements, due to the displacement of the interior spaces and their orientation in relation to external environmental characteristics. The studied and not random design of the openings and their orientation have allowed to develop typological solutions that have been handed down over time and have remained unchanged since the realization of vernacular architectures. Constructive logic and invariants, which have been able to characterize the anthropized landscape in the course of the centuries and which, to a different extent, are evoked to inspire and bring us back to the path of harmonization with the place.

Among the elements that have made the interior comfortable, during the summer months, there are, above all, loggia, balconies, verandas and pergolas, which together gave birth to that

characteristic image of architectural constructions in Mediterranean area and which have represented some invariants for the supply of the natural light.

Among the features that have made significant contributions to the energy issue, some of them are:

- presence of masses of masonry that can give the building housing considerable inertial characteristics. This has been of great help in the archaeological excavation developed on the local natural stone of sedimentary origin. Due to the presence of wall masses used not only as a division between internal space and external space, but also as constituent elements of the structural subsystem, it was possible to obtain optimum control of external temperature variations by mitigating and bypassing the transfer of summer heat from outside to inside;
- continuous improvement regarding the size and exposure of the openings with regard to both thermal transmittance and luminous flux;
- the protection system both from direct sunlight and from external ventilation, for example using the pergola or verandas typical of the Aeolian architecture. And furthermore the use of clear shades for façade plasters that reflect the incident light and reduce the percentage of absorption of solar radiation;
- Reduction of the S / V ratio of the building, thus reducing direct incidence of solar incident on the lateral surface and covering of the building.

For the south-facing facades the use of small size openings and a high mass, typical of high-density materials and common feature of traditional architectures in the Mediterranean area, improved greatly the energy performance of the building enclosure, giving it a function of thermal flywheel and modulating element of the heat flows between the exterior and the interior with consequent energy saving for summer air conditioning and a greater thermal inertia. The openings, made of wood, were often small, especially those exposed to the south, to avoid direct irradiation and excessive heat exchange on summer days.



Figure 2: Traditional houses, farmsteads and courtyard houses in Mediterranean area

5.1 Typology of the courtyard house

The recurrent typology in the studied area is the courtyard house. The theme of the enclosed house is an archetypal theme that perpetuates over the time through spatial conformations that adapt to the functions that were needed in different periods of history. A wire fence on the

plane that refers to a space introverted, isolated and closed. The courtyard is a place opened and empty, an open-air room, the fulcrum of the spatial and functional organisation of the home.

The theme of the courtyard house is declined in the territory analysed given its diffusion. The rural types disseminated in the territory can be traced back to three groups that can be subdivided according to the characteristics that distinguish them. These are in particular or single homes where the dwelling is usually placed on the upper floor, or houses scattered or, still, courtyard houses.

Among the three typologies, the latter is the most widespread, because it is linked to the Mediterranean tradition that is based on various constructive practices used by the Etruscans, the Egyptians, the Greeks, the Romans and the Arabs, who, albeit at different times, privileged the isolated character of the court. Thanks to the advent of the courtyard, air and light were guaranteed, with rare and small windows opened on the road.

The farmhouses developed around the rectangular central courtyard: the courtyard's long sides contained the granary, the oil-mill, the millstone, the straw, the cellars and the houses for the peasants. On the short sides, on the one hand there was the manor house - more refined by the architectural point of view - on the other the stables, the warehouse or a drywall. In the countryside, the presence of courts and farms is organically integrated into the landscape, consisting mostly of rows of vineyards and fruit trees, making it the central hub around which revolve the elements of the environment in a fortunate blend of nature and built.

6. CONCLUSIONS

The aim of the research was to arrive to a proposal for the preservation of the territory, which can provide, through the study of the characters and invariants of the built, indications for its conservation and enhancement. Scattered houses, farmhouses and villas, in the spatial area studied, blend with the landscape in an exceptional integration between natural and built environment. Constructive invariants, markers of historical memory, which have resisted as rocks against the current, are largely a resource that has still to be fully exploited.

But knowing, telling, protecting and promoting the right forms of transformation is a commitment where men and knowledge resources will play an important role. A careful design of such artefacts could help not only qualify the landscape and improve living comfort, focusing on energy saving and renewable resource exploitation, but also determining architectural models to be emulated for the choice of materials and for constructive techniques. Among the 'values' of the landscape one of the most significant is the value of diversity, that should be taken as a key element of the protection. The aim is to consider the transformation as a regeneration. The will and the opportunity of protection is to be developed as an active protection, using local resources in order to define a strategy able, at the same time, to safeguard and to promote them.

The analysis of the signs of history is useful to understand the land and act on it. Not proposing abstract models, standardized and repeatable, it becomes fertile ground for the construction of scenarios in which the differences and peculiarities of a place are revealed and show their uniqueness and irreplaceability. Cataloguing designing materials, typologies, constructive solutions, formal outcomes related to functions and their social significance, urban structures,

landscape elements, and environmental conformations does not mean qualifying the only analytical phase, but instead highlighting how the editing of an archetypal abacus can serve as a support for the design phase, to actualize the forms of the past and to derail rather the logical criteria underlying their transformation.

The main challenge for the next future, for our team, is the construction of an archetypal abacus, able to outline a transferable reading method to other contexts. This method has to be addressed by extending the field of the survey to different geographic contexts in order to identify a double level of reading. On one side, it is applicable transversally to all contexts, distinguishing 'archetypal classes' and, on the other side, time after time is enriched with features related to local material culture, which translate the archetype to the specific context (depending on available materials, climatic region, settlement traditions and social relations).

Identifying the archetypes, recognizing them, refolding them, and updating them is an integral part of the practice, which thus retrieves the epiphany role of the forms, based on these principles and made in the ways that respond to their own time. The widespread culture of the building provides a huge baggage of pictures, a repertoire of constructive archetypes that the designer, nowadays, can not ignore.

7. REFERENCES

- AA.VV. (1973) *La casa rurale nella Sicilia orientale*, Olschki Editore, Firenze.
- Acocella, A. (2004) *L'architettura di pietra*, Alinea Editore, Firenze.
- Agostini, S. (2008) *Recupero e riuso degli edifici rurali*, Maggioli, Santarcangelo di Romagna (Rn).
- Arnheim, R. (1969) *Verso una psicologia dell'arte*, Einaudi, Torino.
- Assunto, R. (1973) *Il paesaggio e l'estetica*, Giannini, Napoli.
- Basile, M. (1873) *Il caseggiato delle aziende rurali*, Tip. D'Amico, Messina.
- Cacciari, M. (1997) *Arcipelago*, Adelphi, Milano.
- Dal Pozzolo, L. (2002) *Fuori città senza campagna*, FrancoAngeli, Milano.
- Decandia, L. (2000) *Dell'identità*, Rubbettino, Catanzaro.
- Fathy, H. (1986) *Natural Energy and Vernacular Architecture: principles and examples with reference to hot and climates*, University of Chicago Press, Chicago.
- Fiorito, F. (2009) *Involucro edilizio*, Flaccovio Editore, Palermo.
- Gambino, R. (1997) *Conservare innovare. Paesaggio, ambiente, territorio*. Utet Libreria, Torino.
- Giucastro, F.G.S. (2012) *L'uso della luce naturale quale materiale invariante in architettura: Incontri dell'Annunziata*, Gangemi, Roma.
- Giucastro, F.G.S. (2008) *The environment built in Siracusa's countryside. Country houses, farmsteads and villas: memories from the past to exploit the territory's peculiarities: 2nd blue+verde*. International Congress Environscape. Dipartimento BEST Politecnico di Milano, Maggioli Editore, Sant'Arcangelo di Romagna (RM).
- Grassi, G. (1967) *La costruzione logica dell'architettura*, Padova.
- Hillman, J., Truppi, C. (2004) *L'anima dei luoghi. Conversazione con Carlo Truppi*, Rizzoli, Milano.
- Laugier, M.A. (1753) *Essai sur l'architecture*, Paris.
- Levi Strauss, C. (1980) *L'identità*, Sellerio Editore, Palermo.
- Lynch, K. (1964) *The image of the city*, MIT, Massachusetts.
- Maldonado, T. (1970) *La speranza progettuale*, Einaudi, Torino.
- Nardi, G., Campioli, A., Mangiarotti, A. (1991) *Frammenti di coscienza tecnica. Tecniche esecutive e cultura del costruire*. Franco Angeli, Milano.
- Nardi, G. (1986) *Le nuove radici antiche*, Franco Angeli, Milano.
- Neumann, E. (1949) *Ursprungsgeschichte des Bewusstseins*, Zürich.
- Picone, A. (2009) *La casa d'araba d'Egitto*, Jaca Book, Milano.
- Purini, F. (1980) *L'architettura didattica*, Gangemi, Roma.
- Rapoport, A. (1969) *House Form and Culture*, Prentice-Hall, Englewood Cliffs.
- Rudofsky, B. (1979) *Le meraviglie dell'architettura spontanea*, Laterza, Bari.
- Truppi, C. (1994) *Continuità e mutamento*, Franco Angeli, Milano.

- Truppi, C. (2011) In difesa del paesaggio, Electa, Milano.
- Truppi, C. (2007) nei luoghi dell'anima con Wim Wenders, Edizioni della Meridiana, Firenze.
- Wright, F.L. (1957) A testament, New York.
- Zevi, B. (1973) Il linguaggio moderno dell'architettura. Guida al codice anticlassico, Einaudi, Torino.
- Zordan, Bellicoso, De Berardinis, Di Giovanni, Morganti (2009) Le tradizioni del costruire della casa in pietra, Alinea, Firenze.

CREATING A VIABLE DOCTOR OF PHILOSOPHY IN THE BUILT ENVIRONMENT: A CASE STUDY SYNOPSIS

L. Thomas

*Civil, Environmental and Ocean Engineering, Stevens Institute of Technology, One Castle Point on Hudson,
Hoboken, NJ, 07030, USA*

Email: Lthomas2@stevens.edu

Abstract: The paper summarizes a case study describing the process of creating a research degree in the Built Environment within a department of civil engineering. Beginning with a brief description of the Built Environment and the PhD degree, rationale is given for the selection of a theory of the Built Environment. The author outlines the process taken for approval to offer a new program at a private, technically oriented U.S. university. Program learning outcomes for the degree along with a detailed curriculum is given. The paper includes lessons learned and arguments used to oppose the program by colleagues. Adjustments to the curriculum made after the inaugural cohort completes the first year are highlighted.

Keywords: Built Environment, Construction Management, Curriculum, Terminal Degree, Theory

1. INTRODUCTION

The summary herein describes the process used to create a research degree in the Built Environment within a department of civil engineering. Although this account is for a PhD at a United States university, some aspects of the process; justification for approval and resulting curriculum approved, should prove illustrative for others desiring the same outcome.

This paper begins with a brief description of a Built Environment PhD program, what it consists of and why such an endeavor is critical for the advancement of Built Environment Theory. Next, the author outlines the process taken for approval to offer a new program at a private, technically oriented U.S. university. Program learning outcomes (PLOs) for the degree, along with a detailed curriculum follows. A discussion concerning the fundamental theory for a PhD in the Built Environment is also included. The case study synopsis also incorporates the nature of opposition encountered from engineering and management science colleagues, and selected adjustments made after the first year.

2. BUILT ENVIRONMENT DEFINED

As its name implies, the Built Environment concerns itself with human-made environments. Further refinement and clarification continues to evolve in the field and can be found in the academic literature (Mowbray and Halse, 2010). Disciplines of management, economics, law, technology and design are integrated into the built environment field. This broad definition and a proposed PhD curriculum is purposefully intended to build upon the theoretical model described by Chynoweh (Chynoweh, 2009). It is hoped that the concepts discussed, and knowledge developed by students enrolled in this degree will contribute to the growth of the Built Environment academic community and Chynoweh's call for a common epistemological axiomatic.

Attempts at explaining the Built Environment as an academic field is further assisted by Chynoweh's theoretical model of its quasi-interdisciplinary nature. Based on Biglan's

Taxonomy of academic fields (Biglan, A, 1973), as shown in Figure 1.

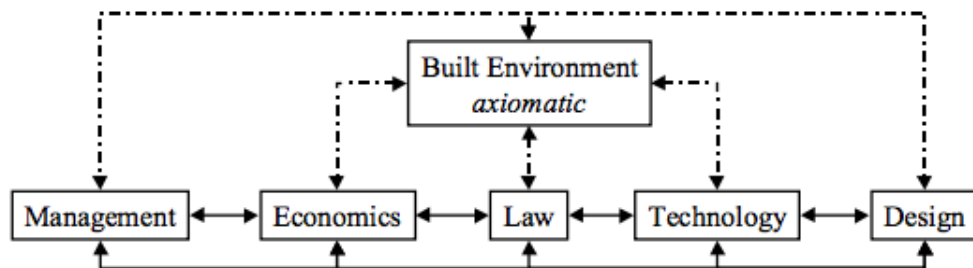

Figure 1 Theoretical Model of Built Environment by Chynoweth (2009)

2.1 Rationale for PhD

Over the past several years the need for professionals to efficiently manage ever more complicated built environment projects has grown (Barg et al., 2014). So has the need for innovation in the field (Rajendran, 2015). This need led to increased academic offerings and also created a need for professors who were experienced in the in the represented industries with terminal research degrees required by universities offering built environment programs (Sacks and Pikas, 2013). As major consumers of the built environment began to reject the old methods of procuring, a need for innovation arose (Collins and Parrish, 2014). Innovation is necessary for progression and refinement and the academy needed to provide graduates with the required knowledge for delivering high-quality projects in an efficient manner that add value to the entity commissioning the work.

For an academic program to survive it must also innovate and evolve, this is accomplished mainly through expanding the current knowledge in a field or research (Halpin, 2007). Thus, the need for scholars asking the relevant questions and testing the resulting hypotheses necessary to create new knowledge exists. In addition having a ready pipeline of scholars ready to serve as instructors in built environment programs is critical (Chynoweth, 2013).

Several higher education institutions have responded to this need. Programs for terminal degrees in the Built Environment in the US have opened although additional programs filling this need may operate under other names such as PhD in Civil Engineering with an emphasis on Construction Management, or a PhD in architecture and others.

3. CURRICULUM DEVELOPMENT

At the subject university, like other institutions of higher education, faculty control the curriculum. Though a series of curriculum committees with increasing jurisdiction, material curriculum changes, new classes and new programs are scrutinized for quality. These committees must act within guidelines of the university and accrediting body's policy.

In the US higher education system, private regulatory associations sanction schools by granting them an "accredited" status. The US Department of Education is a regulatory body but does not directly ensure the quality of education. This is left to school administrators acting in concert with independent accrediting organizations. The organization tasked with making sure

the accreditors are acting in the best interest of the public, is known as the Council for Higher Education Accreditation (CHEA). According to CHEA they are “A national advocate and institutional voice for self-regulation of academic quality through accreditation, CHEA is an association of 3,000 degree-granting colleges and universities and recognizes 60 institutional and programmatic accrediting organizations (Eaton, 2012).

There are three basic types of accrediting bodies, National, Regional and Programmatic. Counterintuitively, the Regional accreditors have the most clout. This means that a school with national accreditation will not necessarily have standards of a similar school which is regionally accredited. The programmatic accreditors are generally informed by the various professional organizations staffed by leaders in the field who are considered the gatekeepers of quality.

The system of accreditors is effective because state licensing boards require an applicant to graduate from a school holding a programmatic accreditation, in turn programmatic accreditors require either national or regional accreditation of the school offering the program. Finally, the national and regional accrediting bodies must be vetted by CHEA. Without CHEA’s recognition the whole scheme fails and graduating from a non CHEA recognized accredited program or school will prohibit a student from being able to sit for licensing exams rendering the degree earned worthless.

4. NEW PROGRAM APPROVAL PROCESS

To maintain the quality of the curricula, new program implementation at the instant university begins with approval of department curriculum committees. In this case the department consists of faculty representing Civil Engineering, Environmental Engineering, Ocean Engineering, Sustainability Management, Construction Management and Construction Engineering and Management. By extension, the curriculum committee comprises representatives from all areas in the department. At the university in question, academic units are organized as depicted in Figure 2.

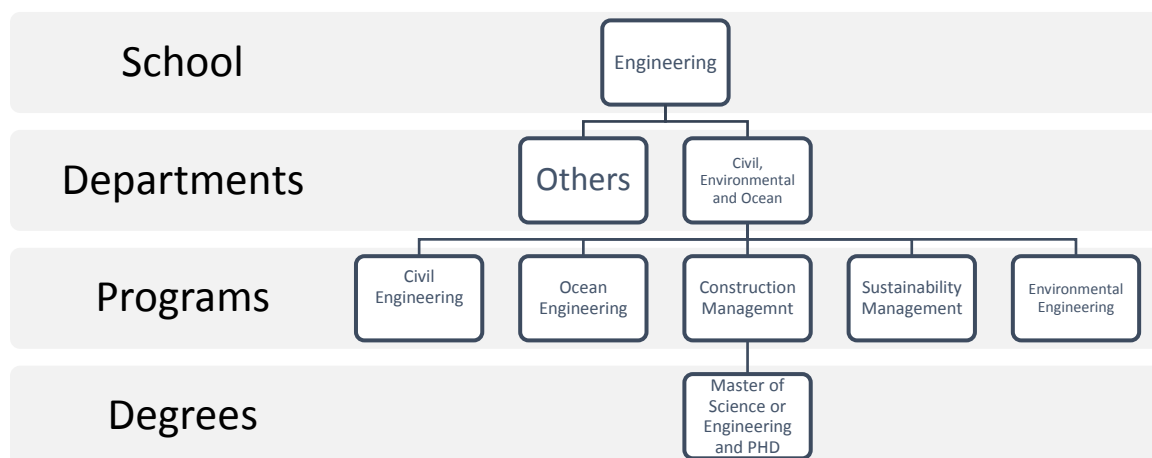

Figure 2 School of Engineering Hierarchy

Once approval from the department committee is obtained, a more comprehensive curriculum committee covering all of engineering and science departments must pass judgement. This committee, made up of faculty from across all disciplines of engineering and science and are tasked with deciding which academic programs are to be offered by the school. At the subject university, this committee is one of the most influential groups on campus. The Graduate Curriculum Committee (GCC) is a deliberative body consisting of faculty members serving two year terms representing various academic fields tasked with maintaining strong programs, adding new programs and preventing subject overlap which contributes to inefficiency. As one can imagine, the definition of subject overlap is relative causing many opportunities for conflicts to arise.

The university registrar, faculty and various curriculum committees all share responsibility for implementing high-quality curriculum. The process steps are typically followed as depicted in Figure 3.

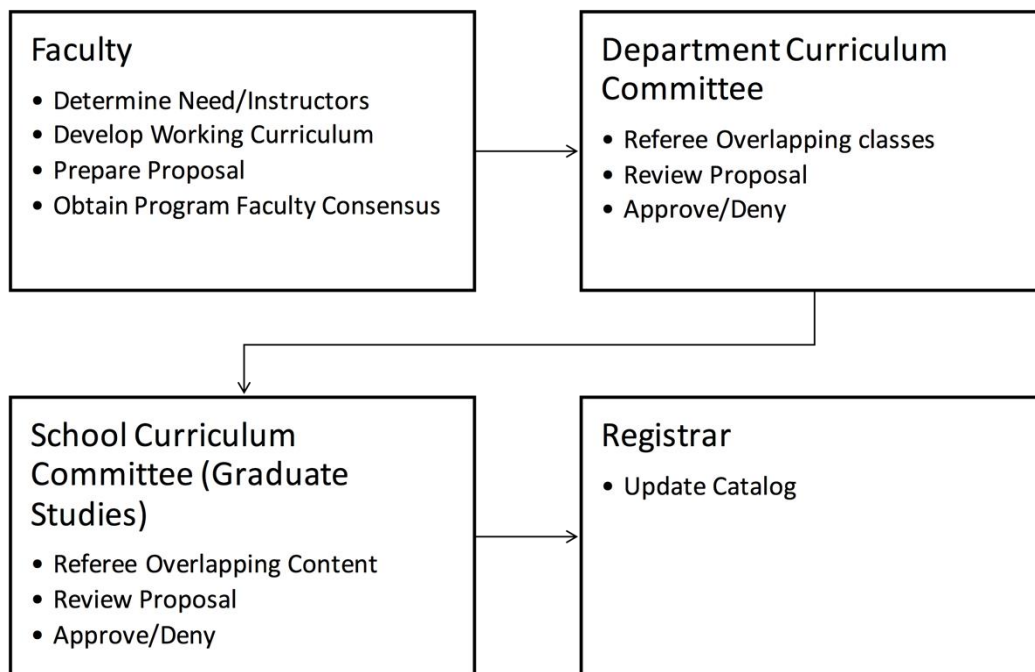

Figure 3 Generic Process for New Graduate Program Approval

In the instant case, because of the unusual nature of the interdisciplinary of a built environment program, several iterations were required for final approval. Figure 4 illustrates this situation.

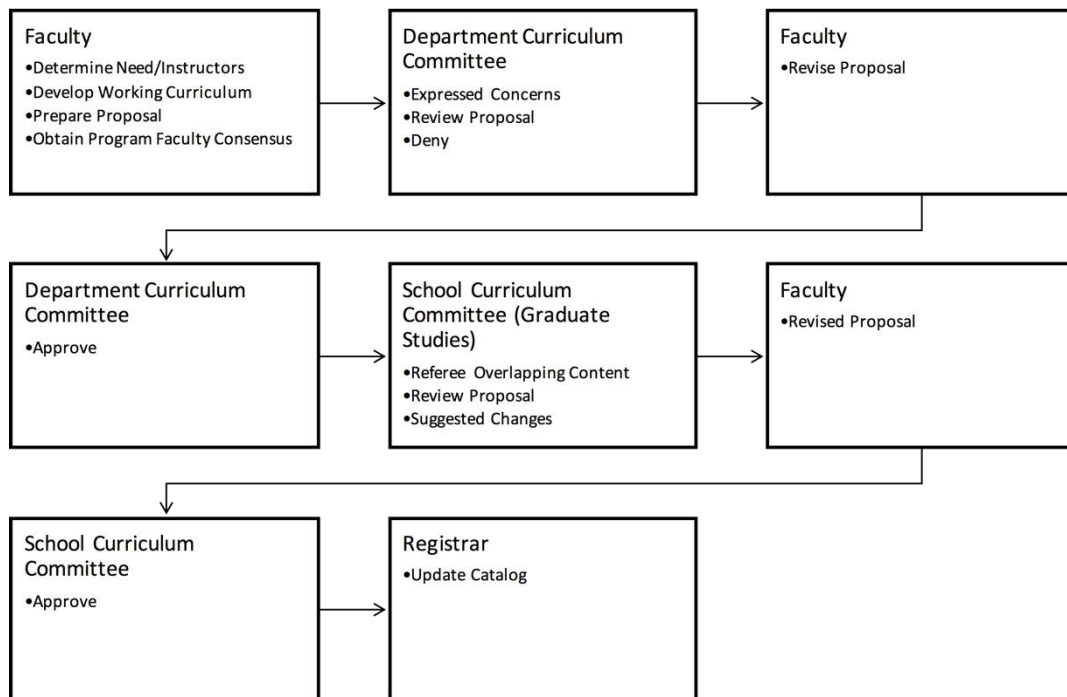

Figure 4 Actual Process for Built Environment Degree

Approval for the program began in May of 2014 and was not officially authorized for acceptance of students until Fall of 2016. There were several reasons for the delay, the most salient for this paper being resistance encountered from faculty members of the two curriculum committees.

4.1 Proposal resistance encountered

Initial opposition to the new program was encountered from members of the department curriculum committee. Since the department of Civil Engineering is under the school of Engineering and Science, whether a PhD in the Built Environment should be considered an engineering degree was debated. Faculty in the department considered themselves gatekeepers of their respective fields and approval of an interdisciplinary degree was not regularly considered. Increasing competition for the best students seemed to prohibit the desire for growth, especially for programs that do not neatly fit within established disciplines. Faculty expressed concern over diluting the engineering disciplines especially when the program in question included scholarship from management and economics which were generally under the purview of the business school. Who would get credit for the program? What type of students would the program attract? Would this programs existence diminish enrollments in similar areas?

By highlighting the opportunity of collaboration with untapped colleagues and the potential to publish in a wider array of journals along with students expressing a desire for scholarship beyond a master's degree in construction management or construction engineering, unenthusiastic approval by the committee was granted. Proposing the program to the Graduate Curriculum Committee (GCC) posed different opposition

The Graduate Curriculum Committee opposed the new program in four major areas. The first two areas of resistance include faculty questioning the need for yet another PhD program; and since existing courses could be cobbled together under the degree of a “PhD in Interdisciplinary Studies” there is no need for a new program, especially in lean times, scope epistemological creep is rampant and counterproductive. Additional arguments against the program consisted of a misunderstanding of the field. Built Environment studies were simply another name for Construction Management. The word “construction” in the title refers to applied technical studies which are trade areas best left to trade school. Also, management, if a science at all, is covered under business programs in another school. Finally, enrollment in Civil Engineering Programs in the US are in general decline, steady at best, investing in more innovative programs with market appeal like Big Data Analytics or Computational Systems is a better use of limited resources.

The third argument for opposing the new program is most relevant to the instant case study. The other reasons given apply to most traditional science and engineering programs, and for the sake of brevity, will not be discussed.

Having to respond to a general misunderstanding about construction management scholarship is familiar to academics in the built environment. The term ‘construction management’ refers to a job title, a of project delivery method and the act of coordinating the implementation of a design. The Construction Management Association of America defines Construction Management as

A professional management practice consisting of an array of services applied to construction projects and programs through the planning, design, construction and post construction phases for the purpose of achieving project objectives including the management of quality, cost, time and scope (CMAA, 2014).

The Classification of Instructional Program Code (CIP) refers to Construction Management as “A program that prepares individuals to manage, coordinate, and supervise the construction process from concept development through project completion on timely and economic bases (“CIP user site,” n.d.).” Many academics outside of the field do not seem to understand the broader definition of construction management and think of those engaged in the field as trades people or general contractors employed to manage the trades people.

To overcome this resistance, arguments for a new program included an explanation of the reach of the industry and how important the built environment is to economic growth; social mobility; and the environment. Failure in implementing complex engineering designs was also presented. Also, the lack of scholars to serve as faculty in built environment programs was also highlighted.

Associated with the argument that the built environment is not a “real” field of study is the notion that there is no theory of the built environment. This argument needed to be examined, not only for approval of the new program but also for the success of the program itself.

5. BUILT ENVIRONMENT THEORY

The theories representing the built environment are currently evolving. In 1991, Bennett offered a new theory of construction management by taking the open system theory of

organizations as a point of departure. The fundamental idea of Bennett's overall theory is that construction projects need to meet the objectives of the customers while maintaining an efficient project organization, and protecting the environment (Bennett, 1991).

In 1992 Koskela introduced the idea construction was closely related to production flow, this has become known as Lean Construction. Although, the application of the lean philosophy to construction is criticized since originally lean production was created for manufacturing efficiency not construction (Koskela, 1994).

By 2011, a theory of construction published by Radosavljevic and Bennett seemed more rigorous (Radosavljevic and Bennett, 2012). Radosavljevic and Bennett's theory used empirical data from past construction projects concluding that efficiency depends on the number of construction teams, the quality of relationships between the teams, external interference and crew performance variability (Radosavljevic and Bennett, 2012).

Although not universally accepted using both Koskela and Radosavljevic and Bennett's theories gave the proposed program a theoretical baseline and a beginning theory upon which to build.

6. PROPOSED CURRICULUM

The proposal submitted to the curriculum committees included a broad program objective in line with other doctoral level programs offered in the US. The objectives of the Doctor of Philosophy include providing built environment theory research experience for doctoral students who might wish to pursue careers in either industry or academia as members of interdisciplinary research teams as well as providing a high-quality doctoral education for those who wish to develop academic careers teaching at the university level.

The program is intended for scholars with a background in the built environment through an advanced degree in Construction Engineering, Construction Management, Architecture or equivalent. A master's degree is generally required before a student is admitted to the doctoral program. Master's level academic performance must reflect the candidate's ability to pursue advanced studies and perform independent research. Students without a graduate level background in the field may be required to take additional classes in Construction Management as determined by the student's committee in the first semester.

Following general guidelines for PhD programs at the school, the course requirements are simple. Students would have to take a total of 84 credits above the bachelor's level. Thirty of those could be satisfied with a Masters-level degree leaving 54 credits. Of the 54 credits students take a doctoral signature course focusing on innovation which is required for all doctoral students enrolled in the university. The remaining credits can be filled with department requirements, elective classes and at least 15 hours of dedicated research credits.

For the Built Environment Ph.D., the requirements include:

- A maximum of 30 credit hours obtained in a Master's program
- A minimum of 15 credits of additional graduate course work
- A minimum of 15 credit hours of dissertation work
- Completion of CM core course requirements
- Completion of Institute Doctoral Signature Course

Core Required Classes (all classes are three credits unless otherwise noted):

- Doctoral Signature Course
- Research Methods in Construction Management
- Strategic Responses to Cyclical Environments
- Foundations of Ethics
- Qualitative Research Methods and Theory Building
- Dissertation Seminar (credits vary)

Quantitative Methods (at least one):

- Modeling and Simulation
- Decision and Risk Analysis
- Quantitative Research Methods
- Statistical Methods
- Probability
- Numerical Methods for Civil and Environmental Engineering
- Probability and Stochastic Processes I
- Regression and Stochastic Methods

Environmental Management (at least one):

- Perspectives in Environmental Management
- Sustainable Design
- Green Construction
- Environmental Analysis and Planning

6.1 Proposed program learning outcomes

The program learning outcomes for the PhD in the Built Environment proved challenging to draft. For all new proposals, the graduate curriculum committee describes program learning outcomes as “narrower statements that describe what students are expected to know and be able to do by the time of graduation.” This general statement seemed broad and not applicable to the degree of doctor of philosophy. Requiring “program-specific” terms presupposes a bright-line distinction among academic fields. At this point in the process the faculty proposing the degree had to decide if the aim is to develop skills graduates would use in employment as a professional—a professional doctorate; or is the goal to create a research degree in the traditional sense.

The larger debate in the education literature over the outcomes expected of a PhD graduate proved relevant to this dilemma. Stakeholders outside of the academy are persuasive in their demand for graduates with skills relevant to professional employability. The very purpose of the degree was questioned in the 2008 Carnegie Initiative on the Doctorate (Walker et al., 2009). Mowbray and Halse argue that the PhD process is better thought of as a process of acquiring “intellectual virtues”, instead of specific skills for contemporary purposes (Mowbray and Halse, 2010). Although the professional doctorate is valuable, the faculty proposing this program chose to agree with Mowbray and Halse. It was thought that the best course of action would be to offer a degree that would prepare graduates for an unknown future while providing them with skills attractive to academic employers. Consequently the program learning outcomes for the PhD, Built Environment are simple:

- Enable students to engage in advanced study and research with scholars in the built environment.
 - This is assessed by reviewing the number of advanced classes taken by students and yearly Graduate Reports which outline students' activities
- Foster original and scholarly research that contributes to the built environment theory.
 - This is assessed by reviewing yearly Graduate Reports and collecting the number of high-quality journal articles published, conferences attended, participation in university's yearly research symposia, and citations of papers written.
- Enable graduates to integrate their professional education and experience with the larger problems of the built environment.
 - This is assessed by analyzing the list of topics researched, hours spent in internships and the university's graduate research symposia.

Requirements in addition to completion of required and elective classes include a series of milestone activities typical to the PhD in the US. Responsibility for the timing and organization to meet these milestones is shared by the department faculty, thesis advisor and the student. This means, the student may initiate the activities and with the help of her advisor using department resources, complete them.

Program learning outcomes are scheduled to be assessed yearly with interventions for improvement noted in the universities electronic assessment system. Changes in the program are assessed every five years with a full program review and are used as evidence for budget requests. The goal in this program is to use evidence-based decision making from assessment data, employer survey results and external oral examiners reports.

In addition to meeting the program learning outcomes and passing milestones as illustrated in Figure 5, students must also show that they are able to plan and execute a successful class offered on campus or via an online platform.

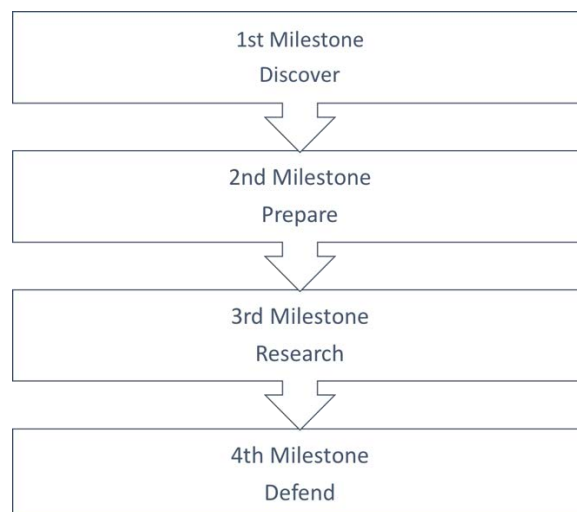

Figure 5 Major Milestone Themes

The pace at which a student moves through the milestones is totally dependent upon the student. To move from the Discover phase, a student must have completed a two-semester PhD Seminar and passed a qualifying examination. The second semester of the PhD Seminar

concludes with each student submitting a topic statement that has been informed by classes, suggested readings and discussions with faculty. During the second phase students are preparing themselves intellectually to take on research on an approved topic. This preparation includes taking any classes needed in methodology or complementary fields that will enable the student to engage in independent research on their chosen question. The second phase ends with the comprehensive examination where the student demonstrates the ability to move into independent research by presenting a fully developed research proposal, including a basic literature review that is acceptable to her committee.

Phase three includes independent research following the approved proposal guided by the dissertation committee. Activities including pilot studies, refinement of the original proposal and potentially change of focus are completed. Once a satisfactory finding, as determined by the student's committee is presented, the dissertation report is drafted. This of course is an interactive process that can take from one academic term to several years. During this process the research proposal may be re drafted and proposed several times. Phase three ends when the student has a viable research project defined, completed, validated and recorded.

In phase four, the student defends her work to the committee and solicits feedback from third parties by attending and presenting at conferences, submitting journal articles and refining the research product. With the successful oral defense of the work and dissertation report the student is released for graduation.

7. APPROVED PROGRAM EXECUTION

The first cohort of students was admitted in the fall semester of 2016. Acceptance into the program was based on an application dossier containing Graduate Record Examination GRE scores, undergraduate and graduate cumulative grade point averages, letters of recommendation from previous professors and a personal interview.

The personal interview is conducted electronically or in person to determine the applicant's reasons for desiring the degree and level of understanding and experience with academic research. The first cohort of applicants were also informed that the program was in its inaugural semester. Of the six applicants completing the application dossier, four were admitted for the fall term. Funding for the students was arranged through a combination of the department funds, Teaching Assistantships and payments for teaching online classes.

Admitted students received an orientation that covered department policy and a suggested sequence for class completion, qualifying exam, research proposal, comprehensive exam, committee selection and residency expectations.

To date, the inaugural cohort has completed the first year. Assessment of the program has given rise to some adjustments, and identified unforeseen challenges not predicted at the program's inception. One significant adjustment includes a new requirement for a research pre-proposal to be submitted along with the application. This will be used instead of a personal statement and allows faculty to align their interests with incoming students.

One unforeseen challenge encountered was finding an adequate number of faculty from external programs to commit to serve as advisors. There still exists hesitancy from tenured-stream faculty to collaborate on "novel" projects. Young faculty are often advised not to stray

from established norms. They are told spending time on avant-garde collaborations may have a negative impact on their academic futures. Promotion and tenure committees are composed of established scholars who are the gatekeepers of academic standards. Simple questions like who will get to “count” the PhD student and exactly what theory is being expanded exist because of the artificial boundaries of the academy. Also, there is uncertainty with regards to publishing outlets since newer, interdisciplinary journals may not have a high impact factor--- a classic “chicken and egg” predicament.

One initiative that may prove useful is the consultant/researcher arrangement. In this model, industry partners with shared problems of a universal nature can provide funding for PhD students in exchange for consultancy services. The arrangement must allow the students to publish sanitized findings. Once a program develops a publication record, external faculty may have more incentive to collaborate. A consultant/researcher initiative is currently being investigated in the instant program.

8. CONCLUSIONS

The research degree in the built environment at the subject university is still in its infancy but current students seem fully engaged. This year, without marketing the program, five students applied for the next cohort, three were admitted. The lower number of admitted students is related more to lack of faculty resources than quality of applicants.

Although too early to tell, the program has the potential for success. External faculty from environmental engineering, mathematics and finance are beginning collaborations with program faculty and students this year.

9. REFERENCES

- Barg, J.E., Ruparathna, R., Mendis, D., Hewage, K.N., 2014. Motivating workers in construction. *J. Constr. Eng.* 2014.
- Bennett, J., 1991. *International construction project management: general theory and practice*. Butterworth-Heinemann.
- Biglan, A., 1973. The Characteristics of Subject Matters in Different Academic Areas. *J. Appl. Psychol.* 57, 195–203.
- Chynoweth, 2009. The built environment interdiscipline: A theoretical model for decision makers in research and teaching. *Struct. Surv.* 27, 301–310. doi:10.1108/02630800910985090
- Chynoweth, P., 2013. Practice-informed research: An alternative paradigm for scholastic enquiry in the built environment. *Prop. Manag.* 31, 435–452.
- CIP user site [WWW Document], n.d. URL <https://nces.ed.gov/ipeds/cipcode/cipdetail.aspx?y=55&cipid=87728> (accessed 6.6.17).
- CMAA, 2014. *Capstone Course: An Introduction to the CM Profession*. Construction Managers Association of America.
- Collins, W., Parrish, K., 2014. The Need for Integrated Project Delivery in the Public Sector. Presented at the Construction Research Congress 2014: Construction in a Global Network, pp. 719–728.
- Eaton, J.S., 2012. *An Overview of US Accreditation--Revised*. Counc. High. Educ. Accreditation.
- Halpin, D.W., 2007. Fifty years of progress in construction engineering research. *J. Constr. Eng. Manag.* 133, 635–639.
- Koskela, L., 1994. Lean construction. Presented at the Proceedings of the National Construction and Management Conference, Sydney, Australia, February 17-18 1994, Institution of Engineers, Australia, p. 205.
- Mowbray, S., Halse, C., 2010. The purpose of the PhD: theorising the skills acquired by students. *High. Educ. Res. Dev.* 29, 653–664. doi:10.1080/07294360.2010.487199

- Radosavljevic, M., Bennett, J., 2012. *Construction Management Strategies: A theory of construction management*. John Wiley & Sons.
- Rajendran, P., 2015. The impact of building information modeling (BIM) to architectural design process.
- Sacks, R., Pikas, E., 2013. Building information modeling education for construction engineering and management. I: Industry requirements, state of the art, and gap analysis. *J. Constr. Eng. Manag.* 139, 4013016.
- Walker, G.E., Golde, C.M., Jones, L., Bueschel, A.C., Hutchings, P., 2009. *The formation of scholars: Rethinking doctoral education for the twenty-first century*. John Wiley & Sons.

W92: PROCUREMENT SYSTEMS

AN EVALUATION OF THE FACTORS FOR A SUCCESSFUL ALLIANCE IN THE UNITED KINGDOM (UK) CONSTRUCTION INDUSTRY

M. Burton and R. Gameson

School of the Built Environment, University of Salford, Salford M5 4WT, UK

Email: m.c.burton@edu.salford.ac.uk, r.gameson@salford.ac.uk

Abstract: Numerous authors have advocated that the construction industry should have advanced and moved away from being an industry beset by 'late delivery, cost overruns and commercial friction'. As the industry examines possible solutions, there has been considerable research and interest in alternative methods of contracting such as 'alliancing'. The aim of this research was to provide a critical review and analysis of the factors contributing to a successful construction alliance in order to identify key factors. A critical literature review highlighted six key factors. These were incorporated into a theoretical framework, which was then tested empirically, using a qualitative methodology. Interviews, with senior construction professionals, active in UK alliancing projects, were conducted and thematic analysis was used to analyse the data collected; comparing interview results with the theoretical framework. The research concluded that four out of the six factors were shown to be significant contributory factors in successful alliances. Following a comparative review between the literature outcomes and the empirical findings a revised framework was produced. The revisions to the framework introduced two new factors: clear investment strategies and the need for clear risk management processes. In conclusion, the research has identified key factors in the success of construction alliances. The final framework could now be tested further empirically, using a larger sample of research participants, in order to validate the research.

Keywords: alliancing, framework, thematic analysis

1. INTRODUCTION

The Department for Business Innovation and Skills [DfBIS] (2013) report highlights the construction industry's value to the UK economy and, states that by 2025 construction should have advanced and moved away from an industry beset by, "*..late delivery, cost overruns and commercial friction.*" (DfBIS, 2013, p.18). As the industry examines possible solutions, there has been considerable research and interest in alternative methods of contracting as an approach to improve construction performance. Forming an alliance is one method of relational contracting that relies upon communication, trust and common goals to succeed (John et al., 2012). Smyth and Pryke (2008, p.245) suggest that successful improvement in innovation should not ignore, "*...the human and social dimension of managing projects.*" They also contend that value added approaches have, "*...for too long been considered as something added through inanimate tools and techniques.*" The Royal Institution of Chartered Surveyors [RICS] (2015) states that construction skills shortages are causing projects to experience difficulties with greater separation of project roles thus contributing to the poor performance which the UK Government has identified. RICS (2015) also suggests that problems were being encountered due to the exit of many experienced construction trades people and professionals following the global financial crisis of 2008. Considering a mixture of perspectives, the purpose of this research is to examine contemporary concepts and determine whether they will contribute to a successful construction alliance. Construction projects are rarely a repeat process, often being characterised by fragmentation of specialist functions that contributes to poor performance and

low satisfaction; relationships have traditionally been transactional and do not incentivise development beyond the immediate near term priorities (Fellows & Liu, 2012).

The aim of this research was to provide a critical review and analysis of the factors contributing to a successful construction alliance in order to identify key issues and factors. This aim was achieved by setting a series of objectives. Firstly, a critical literature review was conducted in order to identify key factors, and produce a theoretical framework. Secondly, the framework was then tested empirically using expert interviews. Finally, theory was compared with the test outcomes in order to present a revised framework. This paper summarises research conducted as part of a Masters degree dissertation study (Burton, 2016).

2. LITERATURE REVIEW

2.1 What is an alliance?

Bi-lateral contracts constrain how each party behaves due to their profit and target driven nature (Smyth & Pryke, 2008). If a company is operating a contract at a loss, the project team will be incentivised to alter its position through the recovery of claims. Macdonald (2005, p.1) describes 'relationship contracting' as, "...a delivery method, including partnering and alliancing as a method that delivers mutually acceptable outcomes for all parties". Walker and Walker (2016, p.89) contend that, "...alliances generally provide sound outcomes that overcome critical problems encountered in many traditional transactional approaches to complex construction infrastructure delivery projects." Attempting to define what an alliance is would be prudent and allow for an understanding of what an alliance agreement can be considered to be, and how it is different from other forms of relationship and traditional contracting such as partnering. According to Chen et al. (2012) their literary review demonstrated that the critical difference between alliancing and partnering is the consideration of risks undertaken versus rewards given, and that alliancing can be defined by its ability to provide its various actors rewards for exceeding the defined performance thresholds, and suitably compensate those who have suffered from a lack of performance. Ingirige and Sexton (2006) determined that the benefits of alternative arrangements, where considerable value can be developed, were not being achieved due to overarching pressure to ensure profitability. Walker and Hampson (2003) stated that alliances are formed and can be categorised from two perspectives: reactive and proactive. They identify the needs by the characteristics shown from their review into the research of others, in that a client or similar organisation has stated a particular requirement and the responding organisations react and form an alliance in order to satisfy that requirement. For example, one of the first alliance projects conducted in Australia, the Wandoo-B oil platform, adopted an alliancing approach because of the client's poor previous experience with a traditional procurement method which resulted in time and cost overruns (Jefferies et al., 2008). Proactive organisations form similar arrangements in anticipation of the requirements demanded by the receiving organisation. Clegg et al. (2002) contend that alliance contracts are a development to avoid the climate of mistrust where participants operate with duplicity and trust is limited. More recent research by Walker and Walker (2016) supports the importance of competitive advantage, resource and capability issues in alliancing.

2.2 Legal considerations

Barnes and Davies (2014) contend that there are four key functions of a traditional construction contract: allocation of risks and the relationship between risks assumed, compensation, disputes and insurance; reduction in effort to document roles and responsibilities; bespoke documents increase transaction costs, and validation of the business model by providing a framework for practice. What is not clear from literature is the basis for the legal formation of an alliance, whether or not it uses advanced technological practices. A relational approach to a contract would provide greater emphasis on the formalisation of task and production monitoring. This approach would offer advantages over bi-lateral contracts that contribute to undesirable behaviours. Initial contract design can significantly influence the outcomes and relationship dynamics between parties (Faems et al., 2008). Such a perspective does not give a clear indication as to other factors that may be different to traditional forms of contract. For example, the removal of damages clauses for poor performance may prevent a spurious claim being presented in order to maintain a return of profit. Also stakeholder maturity is a factor rarely considered which can have a critical impact on the success of alternative arrangements. Ahbahi (2014) reasoned that most collaborative behaviours were required to happen due to unreasonable expectations with minimal input to support the process. The variety of outcomes may impose limitations or support contradictory behaviour to that which is sought and, as such, legal issues are worthy of consideration in this research.

2.3 Technological advancements

Ongoing advancements in technology present both significant challenges and opportunities to the construction industry. Parametric Building Information Models (BIM) continue to replace coordinate based geometric models in order to enhance asset whole lifecycle performance. BIM can be used to enhance a building's design in order to reduce its energy usage and initial capital expenditure by selecting an off-site construction method (Eastman et al., 2011). BIM and off-site manufacturing are just two developing innovations and neither can be considered as recent developments. Halttula et al. (2015) suggest that BIM has been forecasted to solve several problems, but concede that BIM has not always been able to deliver on many of the promised outputs. Many reasons have been given throughout literature for the low adoption of BIM. Barnes and Davies (2014) cite the high training costs whose requirements are very diffuse to identify and vary considerably from one environment to the next. They also describe a skills gap and identify the need for industry standards. Zhao et al. (2015) concluded that educational courses were found to be taught with minimal contextual background and assessed against largely academic criteria. They conducted a series of literature reviews and developed a case study for their research into education and training for BIM and advanced construction processes. The narrow breadth of the research conducted cannot be deemed to apply to all education and training courses. However, the research does highlight the lack of industry support in developing appropriate training. With the construction industry supporting education there is a danger that it may be developed without due consideration to practical application. Zhao et al. (2015) identified a lack of skills in many aspects; not just in the operation of BIM functions.

2.4 Satisfaction and value

The term 'value', as described within a dictionary, gives many meanings in multiple contextual environments. Barima (2010, p.195), in her triangulation study of primary resources, determined that, "...perceived value from the lenses of potential stakeholders can be complex." Acknowledging the limitations of the research, Barima (2010) suggests that the study can increase its understanding by repeating the research in different environments and cultures. Mills et al. (2009) identified trends within their research that may suggest certain companies and individuals can improve their respective performances, leading to improved satisfaction, with greater value alignment. In their case study research Mills et al. (2009) attempted to classify behaviours and qualities attributed to value. Research in the area of satisfaction and value is neither absent nor underdeveloped, yet most research has been conducted in a reactive manner and reaches similar conclusions in that value is a metaphysical property that is beholden to what is perceptible, and as such appears to be relevant to a construction alliance context.

2.5 Competitive advantage

Competitive advantage, by its definition, seeks to obtain a superior position. How an advantage is shaped could be multi-faceted. An organisation that reduces its risk exposure in comparison to a competitor has gained an advantage. The formation of advantages and how they are developed should be considered. Moinggeon and Edmondson's (1996) review of secondary sources concludes that organisational learning is a source of competitive advantage. They conclude that organisational learning can be categorised into four main areas: organisations as embodiments of past learning; individual learning and development in organisations; organisations increasing the capacity for change through active intelligent participation, and individuals gaining awareness of personal causal responsibility and interpersonal skills. Their use of secondary sources, however, constrains the ability of the authors to make generalisations for all possible scenarios. It remains possible that a fifth unknown scenario could be discovered by further research. The authors also do not express the limitations of the research and do not consider wider management theories in business environments. Moinggeon and Edmondson (1996) could have benefitted from a review of Fiedler's contingency theory. Mitchell et al. (1970) validated the theory's main conclusions that organisational leadership and learning is more influenced by situational circumstances. Their primary sourced research contends that there is no single ideal way as one approach may not prove effective in subsequent applications. Irrespective of the differing positions, the literature broadly supports a link between competitive advantage and construction alliances.

2.6 Performance barriers

It would be illogical to assume that an alliance will be successful in every alliance formation. If an alliance is expected to succeed it is of value to examine why an alliance may not perform as well as expected. These terms will have subjective values to each individual; success to one person or group may be deemed a failure by another. Ngowi (2001) concluded that alliances were not necessarily sought solely to improve project performance; it was equally likely they were necessary to improve business performance in order that more new competitive market entrants could be successfully competed against or prevented from competing at all. Ngowi's (2001) analysis suggested that culture, values and expectations were the most significant barrier

to improving performance. These findings are supported by the research of Walker and Walker (2016), identifying the importance of ‘behavioural factors’. These analyses highlight the importance of continued reflection and adaptation during the alliance lifecycle. Lavie et al. (2012) conducted interviews and would challenge Ngowi’s (2001) point of view. They collected survey data in order to test a number of hypotheses related to organisational similarities. Their research concluded that similarity in partners’ organisational and operational routines are critical to success and enhance performance. The most discernible aspect of their conclusions, which suggests deep complexity, determines that cultural difference has limited effect if the organisations are similar. This apparent complexity is suggested to be influential and may illuminate further appropriate factors of relevance to construction alliances.

2.7 An Alliance theoretical framework

Having critically reviewed literature relating to construction alliancing six factors have emerged relating to influence and interaction within an alliance arrangement; they are illustrated in Figure 1 within a theoretical framework. It cannot be determined from the literature reviewed that documented research has considered all factors in every piece of research. The framework is therefore proposed on the premise that the identified six factors are all required to develop a successful alliance in a construction environment. Each factor can therefore be considered as an independent variable requiring others to be addressed in order to create a successful construction alliance; Figure 1 illustrates this. However, by not linking these six factors directly, this shows that the factors are not interdependent.

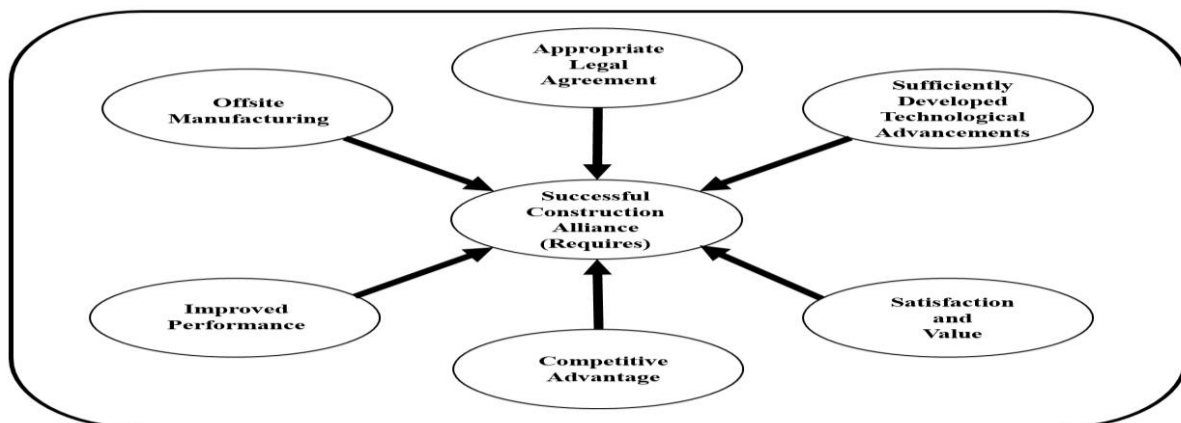

Figure 1: Theoretical Alliance Framework

3. RESEARCH METHOD

This section reviews and develops the research design and considers how the methodology will provide a sound basis for the chosen research method to achieve the research aim and associated objectives. The research method will allow the theoretical framework to be tested and critically examined using empirical data.

3.1 Research approach

Selecting appropriate methods to test the research objectives leads the research to consider questionnaires and interviews due to the methodological focus. Considerable literature is available for researchers concerned with epistemology which implies the notion that qualitative research is for the generation of theory and quantitative is for the testing of theory. For example, Bryman (1992) advocates that considerable benefits can be obtained where a stance in the research method is taken that avoids falling into these narrow paradigms. Hyde (2000, p.82) states that, *“Introducing formal deductive procedures into qualitative research can represent an important step towards assuring conviction in qualitative research findings..”*. Such procedures may resist criticism regarding the inadvertent inclusion of mixed methods research. Positivist theory testing is concerned with the assessment of facts and phenomena in a manner that is often repeatable by another researcher; facts are gathered, quantified and analysed in a method that can be repeated. Bitekine (2007) contends that deductive research with quantitative methods is tested on elements of the environment that are compliant to quantification and statistical methods of analysis. A naturalist interview approach was selected for this research on the basis that it permitted the wider exploration of factors identified in the literature review that a questionnaire approach might inadvertently avoid through the absence of sufficiently detailed information beforehand.

3.2 Data collection method

Having given due consideration to alternative methodological approaches, a data collection method was adopted utilising semi-structured interviews. The aim of the research was to discover what factors can make an alliance successful. To confirm that a factor does indeed contribute to success, a low number of observations will be needed to confirm the suitability and relevance of the factor in question. Bryman et al. (2008) confirms such an approach as valid and avoids the need to confirm simultaneous factors. If the question had an inverted approach, that is to say every successful alliance has the following factors, a much greater population sample would be necessary to achieve saturation. Francis et al. (2010) conducted studies on saturation with interviews of medical personnel. Their findings concluded that saturation occurred at relatively low numbers of around ten interviews on complex subject matters. This research demonstrated that factors can be confirmed with small samples as the factors were neither relevant, nor necessary, in every case. For this research it can be contended that large samples are not practical and are unlikely to produce further information given the loose association of the factors evident from the prior literature review. A population sample of six was chosen which was considered sufficient given the apparent loose association of the factors. With a narrow sample population, only persons in suitably appropriate positions were approached using publically available information and requested to participate in interviews. These individuals were screened for significant senior experience of working on alliancing projects in the UK to establish their suitability to competently answer the interview questions. The use of expert interviews is supported by the work of Walker and Walker (2015) who used them in their research into international relationship-based project procurement.

An interview schedule of 22 questions was developed, linked to the six key factors presented in the theoretical framework. In addition the questions were sufficiently open to allow full exploration of the topic to collect deep and rich information. A small pilot study was conducted to test the questions; in particular with regard to clear understanding to elicit valid and reliable

responses. Before any individuals were approached ethical approval to conduct the research was obtained from the University.

3.3 Data analysis method

The analysis of qualitative interview data often uses thematic analysis as it is widely used and accepted by researchers. Aguinaldo (2012) contends that thematic analysis has no accepted regular approach owing to the variances in collected research data. Hewitt et al's. (2010) research supports the views of Aguinaldo and used thematic analysis to transform significant quantities of interview data into a condensed summary analysis. Such a method of analysis allows prominent themes to be drawn together from different data sets allowing appropriate conclusions to be drawn. Interviews were recorded and transcribed to allow relevant content to be identified in subsequent analysis. Superfluous information was removed and relevant information was utilised to develop and articulate appropriate conclusions (Aguinaldo, 2012). Following the transcription of the interviews, the data were examined to evaluate and code the responses separating extraneous information from that which was appropriate to test the theoretical framework. These identified factors were then recorded by way of record sheets in order that such information could be reviewed as necessary during subsequent interpretation. The collected data was analysed for responses and evidence that would be supportive, contra-indicative or neutral in relation to the theoretical framework and its six key factors.

4. RESEARCH RESULTS

Table 1 presents a summary of the research results, linked to the factors in the theoretical framework. The subsequent sub-sections briefly discuss research interview findings relating to each of the six key factors. Results relating to individual interview respondents are referred to as: 'Respondent 1, 2, 3, 4, 5 and 6' to preserve their anonymity.

Table 1: Comparative analysis between theoretical framework factors and research results

Theoretical Framework Factors	Interview Outcomes	Do Outcomes Support the Theoretical Framework?
Appropriate Legal Agreement	The collected evidence provides significant support for this aspect of the model. Examples were identified to justify this aspect within the framework.	Sufficient evidence supports this aspect of the framework.
Sufficiently Developed Technological Application	Technology may in future be essential to alliances, however the evidence collected suggested that technology is currently viewed as a tool to assist rather than as a requirement for success.	Insufficient evidence to support this aspect of the framework.
Satisfaction and Value	Satisfaction has been shown by the evidence as particularly challenging to determine as a factor for success. The social and non-mathematical nature of success is very difficult to validate as a quantified method of proof. The more social nature of satisfaction however can enhance quantitative metrics through the realisation of the benefits of an alliance.	Sufficient evidence supports this aspect of the framework.
Competitive Advantage	Competitive advantages were shown to be varied in a small sample population and cannot be said to be exhaustive. However, this small sample population has shown that the advantages are not necessarily competitive against peers, but can also be advantages against targets such as regulatory frameworks at a level of national legislation.	Sufficient evidence supports this aspect of the framework.
Improved Performance	Improved performance generated significant input from the respondents. They indicated that success would validate the selection of the alliance and was therefore essential to justify a move away from more traditional contracting methods.	Sufficient evidence supports this aspect of the framework.
Offsite Manufacturing	Off-site manufacturing has insufficient evidence to support the success of an alliance. The collected evidence indicated that this may eventually support programmes of works, however none of the respondents agreed that this was required for success. Aspirations do exist to improve this aspect and so this may change in the future; presently it appears that this is not required for success.	Insufficient evidence to support this aspect of the framework.

4.1 Legal considerations

This factor generated strong replies from all respondents and their respective experiences generated considerable reflection. For example, Respondent 1 indicated that inappropriate contractual agreement wording can cause individuals to refrain from contributing in a manner that they deemed to be beneficial to an alliance. In addition confidentiality, or lack thereof, created an atmosphere that prevented innovation being introduced. Respondent 6 further supported this view and highlighted the complexity regarding intellectual property rights and the challenges this introduced. Five out of the six respondents gave clear examples and indications that an appropriate alliance agreement enabled the alliance to function in the most beneficial manner. Examples of inappropriate drafting were felt to hinder the wider alliance

performance and many agreements were suggested to contain phraseology and language designed to provide betterment to a single party, sometimes at the expense of other parties. No respondents offered any evidence to suggest or contradict this widely held viewpoint and this strongly indicates the validity of the inclusion in the framework of this factor. Save for one respondent, all remaining respondents cited examples where they felt an agreement was inappropriately drafted preventing superior performance. With this evidence recorded, it is reasonable to suggest that this factor of the framework was appropriately supported.

4.2 Technological advancements

The results for the interlinking relationship between alliances and technology were, by comparison with other aspects of the framework, considerably less definitive making any judgement more challenging. Of the six respondents, three did not articulate any potential use for technology in creating or enhancing the success of alliances. From these three respondents it can be determined that technology does not contribute to a successful alliance. Two respondents further indicated that technology is simply not desired by client organisations and they are unwilling to integrate technology into their working practices. From all respondents there was no clear evidence that technology is required for a successful alliance. There were some suggestions that technology can and may help an alliance, and some felt the need to offer technological solutions in order to differentiate themselves from the competition. However, no evidence was offered that supported the technological aspect of the framework and separately distinguishing ambition and business development from successful application. Ambition for improvement in technology however does not appear to confirm that technological applications are necessary for success in an alliance environment. Therefore insufficient evidence existed to support this framework factor.

4.3 Satisfaction and value

Respondents provided their opinions as to what they had found satisfying and dissatisfying about their alliancing experiences. Common factors relating to dissatisfaction were mainly centred around behavioural challenges in that individuals did not embrace the concepts of an alliance and were not modifying their own behaviour for this environment. The respondents were nearly unified in declaring such behaviour as detracting from the satisfaction of an alliance. One respondent indicated that satisfaction was loosely linked to the viability of the business case for that particular project. This respondent indicated that the project was probably less likely to continue if satisfaction could not be achieved. Three respondents went further stating that the achievement of satisfaction would validate the business model and lead to its development. Satisfaction was deemed by respondents to change the view on contracting in general and could lead to shaping future outcomes. Positive satisfaction would appear to allow the respondents to justify contracts engagements and behaviour based at least partially on satisfaction which is unusual practice. It would be unsupportable from this research to state that negative satisfaction would mean that an alliance would be unsuccessful. However, it is reasonable to state that positive satisfaction can be linked with a positive and successful alliance. This is supported by the range of responses given that alliances brought considerable innovation and value for money. It is therefore reasonable to suggest that this factor of the framework was appropriately supported.

4.4 Competitive advantage

The data analysed indicated significant dissatisfaction with alliance arrangements overall and some respondents suggested that alliance performance was below expectations. One particular response indicated that the client organisation had become overwhelmed and was attempting to utilise an alliance arrangement in order to overcome most difficulties with contracting arrangements. Similar views were expressed by another respondent in that they were not able to change behaviour to suit the alliance environment and were expecting improvements immediately. The evidence continued that such environments enabled an environment where the various parties can learn from the other parties, creating a greater, and more accurate, flow of information. Another respondent indicated that resources could be captured earlier and took production capacity away from the other market competitors thereby enhancing and distinguishing their offering. The defining of a competitive advantage provides significant scope for a wide variation in answers and industry appears to be developing business models that represent a significant departure from traditional arrangements between a client and a contractor and so forth. One respondent highlighted how the integration of a series of contracting groups provided market testing of a multi-billion pound capital development plan. This plan was reviewed by the industry regulator who approved it based on the alliance validating that the business plan was deliverable. This particular alliance had clear plans to deliver known outcomes and they were clear in their use of the alliance arrangement to do so. Of particular distinction to this example was that the relationship was mutually beneficial to both parties and both received benefits in that: the client organisation's business performance improved, whilst the contractors gained access to areas of the client organisation's business that was not openly available to them previously. From the findings of the research it is reasonable to assert that this test confirmed the importance of the alliance in providing a competitive advantage and therefore this factor's inclusion in the framework was appropriate.

4.5 Improved performance

The interview questions related to improving performance generated significantly varied responses from all respondents. Improving from a relative starting position could influence the outcome and responses by showing that this matter is not relevant. The questions were structured in a manner that broadly followed a project's lifecycle starting at pre-contract phases moving to development phases and concluding with retrospective questions designed to reflect upon experiences. A question regarding prior expectations produced significant responses that indicated that many potential hindrances to performance existed ranging from employing companies restraining performance due to company operation guidelines, to individuals that did not openly embrace change. These responses indicate a general level of experience and frustration by the respondents, yet the responses did not directly support this aspect of the framework. The questions aimed at the later stages of project lifecycle alter this non-confirmatory appearance as responses generally supported improving the alliance performance. Training and induction were identified by all respondents as essential to improving performance. Such training ranged from formal short courses to a personal induction with persons demonstrating how individuals should behave. The evidence suggests that training brings significant improvement to alliances. This apparent misalignment suggests a possible improvement of the general structure and arrangement of alliances. It remains a possibility that these performance improvements are documented yet simply kept hidden from the operatives within a framework. The evidence gathered suggests that success and improvement

are broadly aligned even if the link is less clearly defined and thus supported this factor's inclusion in the framework.

4.6 Offsite manufacturing

From the evidence collected respondents were not entirely in agreement as to what constitutes offsite manufacturing giving support to the variation of definitions surrounding this topic. Some respondents believed material component sub-parts, such as bricks, were offsite manufactured; others viewed items such as fully assembled modular buildings as offsite manufactured components, as these would previously have been built mostly on a site. With this variance of opinion the possible outcomes could have been equally varied and difficult to establish. Respondent 2 gave examples of how a particular alliance was attempting to use offsite manufacturing to enhance their particular offering. The remaining respondents shared a common viewpoint that offsite methods can be utilised to support construction activities, however each respondent identified a particular challenge to implement such methods. Furthermore each respondent gave replies that simply conveyed offsite manufacturing as a potential area of improvement. Respondent 6 had the most clear and unambiguous opinion that alliance arrangements, and off site manufacturing, were two independent topics and have no interlinking effect upon each other. Separating the distinction between aspiration and corroboration of success justifies drawing the conclusion that offsite manufacturing does not appear to be required for an alliance to be successful and therefore this factor's inclusion in the framework was not supported.

5. DISCUSSION AND CONCLUSIONS

The research analysis has shown that two of the original factors in the framework were not supported by the research conducted: offsite manufacturing, and technological advancements. The exclusion of these factors leaves four that were supported by the research. However, two new factors emerged from the interview analysis that were not as strongly present in the literature reviewed. 'Investment in appropriate alliance strategies, including training issues', and 'the control and allocation of risk' were the two new factors identified as important to successful alliances. All six interviewees identified these two factors as key requirements for an alliance to proceed in a productive manner.

Risk in relation to alliance arrangements is not discussed in great detail, as discovered during the literary review phase. Significant literature is available to discuss risk as an isolated topic, however no specific risk research in relation to alliances in construction was identified. For this reason it could not be justified for inclusion into the initial theoretical framework. Research respondents suggested that risk management would be better suited if it was moved into an alliance arena rather than its utilisation by individual organisations. Such a development is broadly in line with research by Mills et al. (2009) who stated that tools can be used to define value at a project's inception. Equally, this could be tested by revalidating the alliance model for a change where appropriate risk management tools were included prior to a project's commencement removing such decisions entirely from the individuals own grasp and resolving such issues in a more open and project level manner.

Significant evidence was provided by the respondents with regard to wide criticism of alliance projects, stating an expectation on the operators of such agreements to simply just work it out.

Complex agreements, lack of training and unfulfilled potential left the respondents questioning the use and capability of alliance agreements. The use of a pre-planned investment strategy could allow an organisation to address the common issues identified by the respondents which could be justified on the basis of optimising returns. However, this would require further validation to engage and refine the potential scope for an investment strategy.

The critical analysis above has supported the inclusion of the following two factors into the revised framework:

1. Operation of a suitable shared risk management system, and
2. An alliance investment strategy.

The revised framework, shown in Figure 2, is therefore the result of appropriate evaluation of both the theoretical and empirical evidence gathered by this research. Furthermore the critical evaluation has supported the proposed revisions to the theoretical framework. Previously in this research the importance of the social dynamics on construction has been contended as often being ignored. Therefore the framework has been revised to reflect the actual experiences of the respondents, relating to alliance projects, where difficulties have arisen. The initial framework was formed in a more technical manner and did not give sufficient consideration to the ‘human dynamics’ of construction projects.

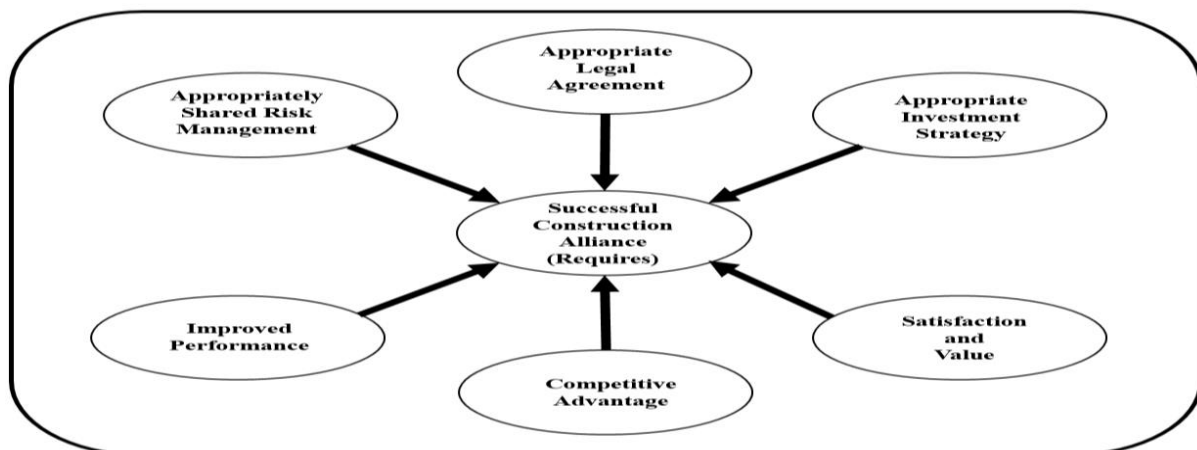

Figure 2: Revised Alliance Framework

Defining an industry standard on what an alliance can be, and equally as important as to what it cannot be, could provide a greater influence than a narrowly focussed piece of research. With an industry standard definition of alliancing, this research could be developed to contribute to the establishment of an industry standard framework for the engagement and operation of alliances. The British Standard Institution’s [BSI], BS ISO 44001 (BSI, 2017) has contributed to this in terms of providing more clarity in the definition and understanding of collaborative relationships and this research is seen as contributing to further development of standards, and a greater understanding of alliancing.

Given the small sample size of the research test conducted it is suggested that further empirical research, with a larger sample size, should be conducted in order to validate the revised framework developed from this research investigation.

6. REFERENCES

- Aguinaldo, J.P. (2012) Qualitative analysis in gay men's health research: comparing thematic, critical discourse and conversation analysis. *Journal of Homosexuality*, 59(2012), 765-787.
- Ahbabi, M.S. (2014). *Process protocol for the implementation of integrated project delivery in the UAE: A client perspective*. (PhD thesis), University of Salford, Salford. Retrieved from <http://usir.salford.ac.uk>
- Barima, O. K. (2010) Examination of the best, analogous, competing terms to describe value in construction projects. *International Journal of Project Management*, 28(3), 195-200.
- Barnes, P., & Davies, N. (2014). *BIM in principle and in practice*. London: ICE Publishing.
- Bitekine, A. (2007). Prospective case study design: qualitative method for deductive theory testing. *Organizational research methods*, 11(1), 160-180.
- British Standards Institution [BSI] (2017) *Collaborative business relationship management systems - requirements and framework*. BS ISO Standard – 44001:2017, BSI.
- Bryman, A. (1992). *Quantity and quality in social research*. London: Routledge.
- Bryman, A., Becker, S., and Sempik, J. (2008) Quality criteria for quantitative, qualitative and mixed methods research: the view from social policy, *International Journal of Social Research Methodology*, 11, 261-276.
- Burton, M. (2016) *An evaluation of the factors for a successful alliance within the construction industry*. Unpublished MSc Dissertation, School of the Built Environment, University of Salford, UK.
- Chen, G., Zhang, G., Xie, Y.M., & Jin, X.H. (2012). Overview of alliancing research and practice in the construction industry. *Journal of Architectural Engineering and Design Management*, 8(1), 103-119.
- Clegg, S.R., Pitsis, T.S., Rura-Polley, T., & Marosszeky, M. (2002). Governmentality matters: designing an alliance culture of inter-organizational collaboration for managing projects. *Organisation Studies*, 23(3), 317-337.
- Department for Business Innovation and Skills [DfBIS] (2013). *Construction 2025*. Retrieved from: https://www.gov.uk/government/uploads/system/uploads/attachment_data/file/210099/bis-13-955-construction-2025-industrial-strategy.pdf
- Eastman, C., Teicholz, P., Sacks, R. & Liston, K. (2008) *BIM handbook: a guide to Building Information Modeling*. [2 ed.], USA: John Wiley & sons.
- Faems, D., Janssens, M., Madhok, A., & Looy, B. (2008). Toward an integrative perspective on alliance governance: connecting contract design, trust dynamics, and contract application. *The Academy of Management Journal*, 51(6), 1053-1078. Retrieved from: <http://www.jstor.org/>
- Fellows, R., & Liu, A.M.M. (2012). Managing organizational interfaces in engineering construction projects: addressing fragmentation and boundary issues across multiple interfaces. *Construction Management and Economics*, 30(2012), 653-671.
- Francis, J.J., Johnston, M., Robertson, C., Glidewell, L., Entwistle, V., Eccles, M.P., & Grimshaw, J.M. (2010). What is an adequate sample size? Operationalising data saturation for theory-based interview studies. *Psychology & Health*, 25(10), 1229-1245.
- Haltulaa, H., Aapaojab, A., & Haapasaloc, H. (2015). The contemporaneous use of building information modeling and relational project delivery arrangements. *Procedia Economics and Finance*, 21(2015), 532 – 539.
- Hewitt, A., Howie, L. & Feldman, S. (2010), Retirement: what will you do? A narrative inquiry of occupation-based planning for retirement: implications for practice. *Australian Occupational Therapy Journal*, 57, 8-16.
- Hyde, K. F. (2000). Recognising deductive processes in qualitative research. *Qualitative market research: An International Journal*, 3(2), 82-90.
- Ingirige, B. & Sexton, M. (2006). Alliances in construction: investigating initiatives and barriers for long-term collaboration. *Engineering, Construction and Architectural Management*, 13(5), 521-535.
- Jefferies, M.C, Gameson, R., Chen, S.E., & Elliott, T. (2008) The Justification and implementation of project alliances - reflections on the Wandoo B development. *Journal of Construction Procurement*, 7(2), 31-41.
- John, F.Y., Yeung, A., Chan, A., Chan, B., & Daniel, W.M. (2012). Defining relational contracting from the Wittgenstein family-resemblance philosophy. *International Journal of Project Management*, 30(2012), 225-239.
- Lavie, D., Haunschild, P. R., & Khanna, P. (2012). Organizational differences, relational mechanisms, and alliance performance. *Strategic Management Journal*, 33(20 April), 1453-1479.
- Macdonald, C. (2005). *What are the important differences between partnering and alliance procurement models and why are the terms so seldom confused?* Retrieved from: <http://cms.3rdgen.info>
- Mills, G.R., Austin, S.A., Thomson, D.S., & Devine-Wright, H. (2009). Applying a universal content and structure of values in construction management. *Journal of Business Ethics*, 90(40), 473-501.
- Mitchell, T.R., Biglan, A., Oncken, G.R., & Fiedler, F.E. (1970). The contingency model: criticism and suggestions. *The Academy of Management Journal*, 13(3), 253-267. Retrieved from: <http://www.jstor.org>

- Moinggeon, B., & Edmondson, A.C. (Eds.). (1996). *Organizational learning and competitive advantage*. Retrieved from: <http://web.b.ebscohost.com>
- Ngowi, A, B. (2001). The competition aspect of construction alliances. *Logistics Information Management*, 14(4), 242-249.
- Royal Institution of Chartered Surveyors [RICS] (2015). *Britain faces bleakest construction skills shortage in almost 20 years*. Retrieved from: <http://www.rics.org/uk/news/news-insight/press-releases/britain-faces-bleakest-construction-skills-shortage-in-almost-20-years/>
- Smyth, H., & Pryke, S. (2008). *Collaborative relationships in construction*. Oxford: Wiley-Blackwell.
- Walker, D. H. T., & Hampson, K. (2003). *Procurement strategies a relationship-based approach*. Retrieved from: <http://www.onlinelibrary.wiley.com>
- Walker, D.H.T. & Lloyd-Walker, B.M. (2015). *Collaborative project procurement arrangements*, Project Management Institute, Newtown Square, PA.
- Walker, D.H.T. & Lloyd-Walker, B.M. (2016). Understanding the motivation and context for alliancing in the Australian construction industry, *International Journal of Managing Projects in Business*, 9(1), 74-93.
- Zhao, D., McCoy, A.P., Bulbul, T., Fiori, C., & Nikkhoo, P. (2015). Building collaborative construction skills through BIM-integrated learning environment. *International Journal of Construction Education and Research*, 11(2), 97-120.

SO WHY IS UK CONSTRUCTION PARTNERING NOT WORKING THE WAY IT WAS INTENDED?

J. Challender, C. France and H. Baban

¹ *Estates and Facilities, University of Salford*

Email: J.Challender2@salford.ac.uk

Abstract: The study aims to explore why partnering practices within the UK construction industry have failed to realise the full extent of benefits and positive effects, which have been experienced in sectors such as manufacturing and therein simply not lived up to expectations. As part of the study interviews were conducted from a sample of contracting, consulting and client organisations with experience of partnering procurement in construction. Key findings from the study indicate there are problems challenging the philosophy of partnering, brought about through the unwillingness to forge collaborative relationships through the absence of trust. Indicating relationships forged within highly competitive commercial environments, have undermined the spirit of collaborative working built on shared values, outcomes and trust. Furthermore, the integration of project teams and motivations for win-win scenarios have not always transpired in practice which has created partnering arrangements that are more similar in nature to traditional procurement methods. In consideration of the above the study gives an understanding of how effective trust building mechanisms can be implemented for improving project outcomes.

Keywords: Collaboration, Partnering, Procurement.

1. INTRODUCTION AND BACKGROUND TO RESEARCH

1.1 Collaborative working and procurement in the UK construction industry

The purpose of this paper is to examine and investigate why partnering arrangements, have not always led to successful outcomes, in the UK construction industry.

There has long been an academic view and general perception that there is a silo mentality within the construction industry which relates to a general lack of integration of design and construction (Cartlidge, 2004, p.11). This is also supported by Latham (1994, p.17) in that the separation of design and construction may result in a lack of coordination. Collaborative working at an early stage between contractors and design teams has been ‘post Latham’ regarded as a means to bridge the gap between design and construction and thereby reap the benefits of both traditional competitively tendered single stage and design and build contracts. More recently this has become a major feature of ‘Moderise or Die’ (Farmer, 2016).

Perceived benefits could emanate from the early intervention of contractors, and include early starts on sites, utilisation of contractors’ management skills, buildability, contractors’ procurement knowledge, supply chain knowledge, contractors’ health and safety expertise, dispute avoidance, clients’ involvement in the procurement of subcontractors, reduced tender costs and improved team working between contractors and design teams (Egan, 1998; Egan, 2002; Lann *et al.*, 2011; Chan *et al.*, 2004; Hansen and Nohria, 2004; Critchlow, 1998; HM Government, 2013). Furthermore traditional procurement methods may be less suitable on complex and challenging projects which are reliant on greater contractor cooperation and

interface especially at the design stages. In such cases more collaborative procurement routes could have a positive impact on the project success (Eriksson and Westerberg, 2010). Some employers however are still of the mind that competitive and open procurement systems, that truly market test prices, are the only way to assure stakeholders of lowest possible initial capital cost (Ross, 2011; Gadde and Dubois, 2010).

Whilst there is a wealth of previous studies relating to collaborative procurement, this research is designed to be unique in specifically considering the importance and influence of human and organisational factors on collaboratively procured projects. Using key performance indicators such as cost predictability, quality, value for money, risk and project duration, this study seeks to explore whether collaborative procurement routes do in fact deliver improvements and more successful outcomes for projects.

2. REVIEW OF LITERATURE

2.1 Overall context and background to collaborative procurement within the UK construction industry

It is suggested that collaborative working reduces the negative aspects of construction procurement, minimising conflicts and disputes through increased cooperation, and developing relationships built on trust (Larson, 1997; Challender *et al.*, 2013; Walker 2009). This in turn could bring about an increase in through sharing expertise, knowledge, ideas, innovation, best practice, and promoting efficiencies and improvements in decision making (Hansen and Nohria 2004; Tam 2000; NAO, 2001).

In recent years, however, collaborative procurement has also attracted its critics. The RICS (2005), for instance, reported that successful experiences in collaborative procurement ‘are largely anecdotal and focus on the experiences of exemplar organisations.’ They argued that the focus on success rather than failure had presented an unbalanced view and false impression in terms of the contribution that partnering and collaborative procurement has had within the construction industry, and therefore raised questions around reliability. A similar argument was presented by Morgan (2009), formerly Procurement Director at BAA, who concluded that with major capital projects, procurement routes that promote alliances and partnerships are not always appropriate. Morgan found that partnering projects are often open to abuse owing to the scale of the commercial interests involved, do not guarantee success, and clients may be paying far too much for their products. A perhaps more controversial argument is presented by Alderman and Ivory (2007) who describe partnering at its worst as ‘a disruptive smokescreen behind which to conceal business as usual while at the same time motivating suppliers and contractors to go the extra mile.’

3. RESEARCH METHODS

3.1 Methodology for data collection and analysis

In order to further explore collaboration and partnering, within a contemporary period of economic austerity, and also examine the role of trust within this context, a qualitative study was undertaken (Flick, 2009). This approach enabled the exploration of key themes, understandings and attitudes of those who work within this environment on a daily basis.

Semi-structured in-depth interviews (Gillham, 2005) were held with eight North West UK construction professionals from different construction industry disciplines; a client project manager, property lawyer, architect, quantity surveyor, main contractor, subcontractor, mechanical and electrical engineer and a structural engineer. A purposive sampling strategy was employed which involves a judgmental, selective or subjective technique where the sample is usually quite small and therefore not designed to be representative of the population at large. The lead researcher used his judgment to select professionals with experience in many different types of construction procurement including partnering, and all who have had experience in representing client organisations. However, beyond these two criteria, the sample was one of convenience. Whilst the small sample size does not allow for generalisation, it does provide insight into the perceptions of those working within the construction industry during the economic crisis, and their understanding of trust in collaborative working. Consultations were carried out to plan and formulate the format and structure for the interviews. A ‘pilot’ interview was conducted to obtain feedback on the data collection tool, and tease out any difficulties with the way it was designed and administered.

The interviews were undertaken in a period of austerity; late 2015 to early 2016. They were digitally recorded, transcribed verbatim, coded qualitatively and sorted (Silverman, 2001; Langdrige, 2005). Qualitative coding is the careful selection of single words or short phrases to summarise larger sections of text; the codes thus become the basis for sorting. In the sorting process, like coded sections of text were brought together to allow the researcher, as an analyst, to interpret and condense the raw data. Examples of the codes included ‘informal engagement’, ‘closer interaction’ and ‘good team working’ whereas examples of the main themes included factors that instill trust and potential barriers to collaborative working. Codes which are deemed to be related are given umbrella ‘theme’ titles; example themes included ‘factors that instill trust’ and ‘potential barriers to collaborative working.’ As recommended by Taylor and Bogdan (1998), the raw data was summarised in tables; codes were listed, themes developed, content analysis data presented, key literature sources identified, data consistencies and inconsistencies noted and propositions made. The tables became a plan to develop a narrative to construct a contemporary picture of partnering and collaborative working in austere times.

4. RESEARCH FINDINGS AND DISCUSSION

4.1 General findings

Whilst there is academic consensus that collaborative working can create an improved working environment, facilitating better individual and team performances, it was met with some scepticism from some of the construction professionals interviewed. Suspicion of realisable benefits has emerged from the research accordingly. For example, cost savings for clients from collaborative working are perceived by some of those interviewed as being exaggerated over time and certainly have not been realised on all projects. Whilst shared ethos built upon trust between partners is supported theoretically, according to those interviewed, rarely is there realisation in practice. Whilst the construction professionals found collaboratively procured contracts can facilitate successful projects in some instances the study also uncovered negative experiences in sharing information, inequitable working relationships and prompt payment initiatives, leading to organisational mistrust in some extreme cases.

4.2 Quality control and time

The construction professionals reported that collaboratively procured contracts on longer projects, which potentially involve sophisticated and challenging phasing and programming to best suit specific employer's requirements, could potentially offer more scope than traditional procurement routes in reducing overall project durations. This was explained in terms of enhanced teamwork and contractors working alongside clients with common objectives to achieve phased handover dates; especially when working within live building environments, where disruption to the overall end-users' operations is a key issue. In this way they concurred that construction programme timescales could possibly be improved at the early design stages by working with contractors to specify the most suitable and conducive materials and construction techniques to suit the nature of projects. Furthermore through improved team integration they considered that collaboratively procured contracts have the potential to raise levels of quality and performance through reduced conflict, allow more efficient deployment of resources, increase job satisfaction and facilitate fewer defects on completion.

Interviewees generally agreed that specialist input and value engineered solutions at an early stage could shorten pre-tender periods whilst enhancing quality control, giving greater client satisfaction. They also concurred with Walker (2009) and Erikson *et al.* (2010) that procurement routes should be tailored to the nature of projects especially with the growing trend for more demanding deadlines and project outcomes in recent years where traditional procurement routes may be deemed less effective and unsuitable. Views were also presented that partnering could be more successful than traditional procurement routes where health and safety issues on projects represent greater risks to programme and quality. This was explained through the intervention of contractors at preliminary design stages with the associated benefits of early dialogue to address and overcome such issues.

4.3 The importance of trust

The study suggests that possibly the strength of trust is more dependent on individual personal relationships, developed from mutual respect, rather than simply 'good' working relationships. According to those interviewed trust generated from previous relationships and dealings between individuals at senior levels is regarded as critical in the cascading of trust throughout organisations, and between those currently operating partnering arrangements. Not surprisingly at an operational level, 'human' factors such as integrity, honesty, consistency, reliability and competency are regarded as important in facilitating trust and good collaborative working. Such factors are suggested by Thuraujarah *et al* (2006) and Coulson-Thomas (2005) and confirmed by the interviewees, to be vital for the greater integration of project teams. Yet, hard factors are also put forward by those interviewed as crucial in collaboratively procured contracts: experience, technical ability, education and competence of individuals, management systems, resources, and commitment of the organisations.

The interviewees all agreed that a 'culture' of trust allows projects to move forward effectively, and creates an environment where problems can be shared and therefore solved more easily. In this regard, they believe that trust is not something that can be engineered through contractual conditions, nor through procurement routes alone, but needs to be developed, built up and earned over time. Notwithstanding this, they concurred that where trust is compromised, this could lead to a downward cycle of mistrust where working relationships may become untenable. The study also highlighted the belief from those interviewed that the perceived

return to short-term contracts and the constant quest for lowest initial bid price could be jeopardising the development of trust between organisations. However, where long-term organisational collaboration links to potential future work-stream, the development of trust within such relationships may become 'incentivised' and consequently active in practice.

4.4 Client risk, value for money and construction cost predictability

Those interviewed suggested that collaboratively procured contracts can potentially provide more effective open book mechanisms for developing final contract sums with contractors, to ensure that tendering processes are fully transparent, fair and appropriate in most cases. They outlined that there are still too many instances of contractors in traditional contracts inflating the value of claims for variations. For this reason collaborative working under partnering may offer an alternative procurement route in managing such claims to lessen risks of overspend and potential contractual disputes. In this way commercial issues could possibly be identified earlier and addressed accordingly to avoid potential delays and protracted disputes through early dialogue and communication.

Some of the interviewees did, however, not share the positive views of the other construction professionals and reported that collaborative working has been tainted by inequitable working arrangements which potentially give little or no benefits to partnering organisations. In some cases, anecdotal evidence was presented of organisations that suffered financially under partnering and such reports could reinforce fears and anxieties over risks within the industry, promoting a reluctance to move away from traditional working methods. Arguably this disparity of power between clients and other organisations may have allowed the former to use the power derived from scarcity of work in the construction sector to use a 'take it or leave it approach' and potentially to intimidate contractors into accepting unfair returns under the banner of a collaborative arrangement. The temptation to abuse power by their construction clients to secure gains at the expense of others, appears to possibly have become too much to resist in some cases. The project managers felt that such a shift in philosophy during operational partnering frameworks, rendered organisations highly vulnerable to exploitation as they are virtually held to ransom; to accept revised or reduced terms, or be cast back into 'the other' competitive cut-throat market place. Such exploitation through partnering frameworks may increase the risk of this procurement option, reducing its attractiveness and contributing to a reduction in willing partners. Other concerns emerged from the study including the potential fears or unwillingness of partners to share information that could be regarded as commercially sensitive.

4.5 Project complexity and specialism

The construction professionals concluded that collaboratively procured contracts are best suited to large or complex projects where, in the early stages especially, the expertise of contractors in value engineering and project logistics would be extremely beneficial. As an example, one of the interviewees referred to a refurbishment scheme on a museum which incorporated a sophisticated and complex mechanical and electrical installation. It was explained that the building services were designed around the specialist's requirements for a technologically advanced building management system. For this reason, partnering presented the most appropriate and suitable options to ensure that interfaces of specialists' expertise were introduced early in the life of that particular project. Conversely where projects are less

complicated the project managers deduced that benefits from partnering may be significantly reduced, since early contractors' specialist advice may represent essential rather than desirable inputs. This tends to confirm findings from Hackett *et al.* (2007) and Egan (1998) that for some simpler projects, collaborative procurement routes may not be a suitable option, particularly where contractors and subcontractor's expertise and inputs in the early design are less critical.

The duration of projects may also have some influence over the success of partnering in practice. For instance one of the construction professionals advised that shorter projects do not facilitate enough time to build strong working relationships and for partners to become familiar with each other's ways of working. Furthermore there was a view that more controlled financial management on projects through partnering and collaborative working could be achieved on projects with longer contract durations. The explanation for this was that longer projects can give rise to more variations as clients' requirements change over time and partnering can facilitate more cost effective solutions than under traditionally procured contracts. One interviewee also suggested that longer projects provide more time for reflection on alternative building systems and ways of working which could provide the most suitable context for value engineering. It was also felt that when managing clusters of many projects of short duration strategic partnering may be more desirable than project partnering, as trust can be generated within encouraging contexts, where the developmental nature of this collaborative process aligns with the long-term vision of integrated teams.

5. CONCLUSIONS

5.1 Summary of interviews

Collaboratively procured contracts in some cases but not all can, according to the interviewees, bring about reduced project durations, improved cost certainty, enhancement in quality of build and benefits to project management and construction innovation.

The construction professionals strongly felt that assessing the suitability of projects to be collaboratively procured is critical to realising the potential benefits in practice. Certainly on very complex projects it was generally accepted that the early intervention of contractors, subcontractors and suppliers was essential for a collaboratively procured contract to be successful. Where more traditionally procured forms of contract, based on separation of the design and construction may be mostly unsuitable.

In addition to organisational factors it was identified, less tangible and softer human factors and outcomes could be used as key performance indicators to measure the success of projects throughout partnering arrangements. These include motivation, teambuilding, trust and respect which were felt to be more likely to be generated through partnering contracts, and in doing so creating the right environment for successful projects.

Perhaps the most surprising outcome from this study is that the practitioners regarded the individuals deployed on projects as having more influence on the success of a project than the choice of partnering *per se*. They believe that both traditional and collaborative procurement could produce successful outcomes provided that the right individuals are employed, with suitable experience, expertise, motivation and proactive attitudes to team working.

5.2 Barriers and best practice

The study clearly highlights the issues and barriers to the successful implementation of collaboratively procured contracts, including factors related to fairness, cooperation and the sharing of information. To overcome these barriers the interviewees recommended, ensuring that the nature of the project and partnering are appropriately matched, testing the suitability and compatibility and choosing the most appropriate contractors through a robust selection process. This will then hopefully ensure the right choice of partners are fully committed to 'the spirit of collaboratively procured contracts' and make sure individuals and organisations don't just 'pay lip service' to its philosophies and values.

Without the right commitment it was felt that partners will feel propelled to 'collaborate' by the terms of the contract, could risk reversion back to traditional adversarial behaviours.

5.3 Limitations

One of the limitations of this study is clearly that it was based on a very small sample of interviewees. This has reduced the reliability and validity of the study and the study findings clearly are not representative of the population at large accordingly. It is intended that further quantitative work with a larger sample and broader range of experienced construction professionals may need to be undertaken to interpret existing data more effectively.

6. RECOMMENDATIONS

There are a growing number of procurement frameworks being used particularly by the public sector, to reduce project programs and improve cost certainty, which are largely based on partnering contracts and the collaborative working ethos. Due to the foreseen increase use of partnering contracts through such frameworks it is imperative that both client and contractor organisations have a full understanding of contractual mechanisms and collaborative relationships, to realise the cost, quality and time benefits partnering can bring.

It is recommended that training and professional development is used to promote partnering and collaborative working principles, this will also help to gain a wider organisational acceptance and raise awareness of the benefits.

A second recommendation would perhaps be to use BIM as a management tool in encouraging greater collaboration could assist in changing the culture of the UK construction industry and facilitate integration across the whole supply chain to address perceived deficiencies.

7. REFERENCES

- Alderman, N and Ivory, C. (2007), Partnering in major contracts: Paradox and Metaphor, *International Journal of Project Management*. **25**(2007):386-393
- Carlidge, D. (2004), *Procurement of built assets*. London: Butterworth-Heinmann.
- Challender J, Farrell P, and Sherratt, F. (2013), Collaborative procurement: an exploration of practice and trust in times of austerity. In: Smith, SD and Ahiaga-Dagbui, DD (Eds.) *29th Annual ARCOM Conference*, 2-4 September 2013, Reading, UK, Association of Researchers in Construction Management, 827-836.

- Chan, A P C, Chan, D W M, Chiang, Y, Tang B, Chan, E H W and Ho, K S K. (2004), Exploring critical success factors for partnering in construction projects. *Journal of Construction Engineering and Management*. **130**(2):188-89.
- Coulson-Thomas, C. (2005), Encouraging partnering and collaboration. *Industrial and Commercial Training*. **37**(4):179-84.
- Critchlow, J. (1998), *Making Partnering Work in the Construction Industry*, Oxford: Chandos Publishing Limited. 13-18.
- Egan, J. (1998), *Rethinking Construction*, The Report of the Construction Task Force. London: DETR. TSO.
- Egan, J. (2002), *Accelerating Change*, London: Rethinking Construction.
- Eriksson, P E, Westerberg, M. (2010), Effects of cooperative procurement procedures on construction, *International Journal of Project Management* **29** (2011): 197-208.
- Farmer, M. (2016), *Modernise or Die: The Farmer Review of the UK Construction Labour Market*. London: Construction Leadership Council.
- Flick, U. (2009), *An Introduction to Qualitative Research*, 4ed. London: Sage Publications Limited.
- Gadde, L E and Dubois, A. (2010), Partnering in the construction industry - problems and opportunities. *Journal of Purchasing and Supply Management*. **16**: 254-63.
- Gillham, B. (2005), *Research interviewing: the range of techniques*. Maidenhead: Open University Press.
- Hackett, M, Robinson, I and Statham, G. (2007), *The Aqua Group Guide to Procurement, Tendering and Contract Administration*, London: Blackwell Publishing. 116-117.
- Hansen, M T and Nohria N. (2004) How to build a collaborative advantage, *MIT Sloan Management Review*, **46** (1), 22-30.
- HM Government (2013), *Construction 2025. Industry Strategy: Government and Industry in Partnership* London: HM Government. 23-25
- Langdrige, D. (2005), *Research Methods and Data Analysis in Psychology*. Pearson Education: Harlow.
- Lann, A, Voordijk, J and Dewulf, G. (2011), Reducing opportunistic behaviour through a project alliance *International Journal of Managing Projects in Business*, **8**(4): 660-679.
- Larson, E. (1997), Partnering on construction projects: A study of the relationship between partnering activities and project success, *IEEE Transactions on Engineering Management*. **44**(2): 188-95.
- Latham, M. (1994), *Constructing the Team*, London: The Stationery Office.
- National Audit Office (2001), *Modernising Construction*, Report by the Controller and Auditor General HC 87 Session 2000-2001. London: The Stationery Office. 5-6
- RICS (2005), An exploration of partnering practice in the relationships between client and main contractors, *Findings in Built and Rural Environments*. London: RICS Research. 2-3
- Ross, A. (2011) Supply chain management in an uncertain economic climate: A UK perspective, *Construction Innovation* **11**(1): 5-13.
- Silverman, D. (2001), *Interpreting Qualitative Data: Methods for analysing talk, text and interaction*, 2ed. London: Sage Publications Limited.
- Tam, C. (2000), Design and build on a complicated redevelopment project in Hong Kong: the happy valley racecourse redevelopment, *International Journal of Project Management*, **18** (2): 125-129.
- Taylor, S and Bogdan, R. (1998), *Introduction to Qualitative Data Research Methods*. 3rd Edition. New York: John Wiley.
- Thurairajah, N, Haigh, R and Amaratunga, R D G. (2006), *Cultural transformation in construction partnering projects. COBRA. Proceedings of the Annual Research Conference of the Royal Institution of Chartered Surveyors* 7-8 September. University College London.
- Walker, A. (2009), *Project Management in Construction*, Oxford: Blackwell Publishing Ltd.

THE INFLUENCE OF PROCUREMENT STRATEGIES ON SME CONTRACTOR DEVELOPMENT IN THE CONSTRUCTION INDUSTRY

A. Windapo and A. Adediran

Department of Construction Economics and Management, Faculty of Engineering and Built Environment, University of Cape Town, Rondebosch 7701, Cape Town, Western Cape, South Africa.

Email: Abimbola.Windapo@uct.ac.za

Abstract: The study examines the procurement strategies used by public sector clients on projects in which the intention is to develop small medium enterprise (SME) contractors and whether the system used influences contractor development. The study rationale is based on the view held by scholars that the assumption of homogeneity of the SME population has led to the imposition of 'SME-friendly' policies which hinder the development of SMEs. The study makes use of extant literature review and employs a quantitative research approach involving the utilisation of a survey research design in data collection. The study revealed that traditional procurement strategy is still the most preferred procurement strategy used by public sector clients in contractor development. It was also found that the highest aggregate level of SME development was achieved when integrated project procurement strategy is used, particularly among small SMEs. The study concludes that there is a slight mismatch between the preferred choice of procurement strategy – the traditional project procurement approach and SME development outcomes for different SME sizes, and that the achievement of SME development has little to do with preferences or the use of specific procurement strategies and nothing to do with the size of SMEs except where traditional project procurement is used. The study recommends that public sector clients should not entirely treat SMEs as a homogenous block when using traditional project procurement; the use of integrated procurement strategies may be promoted for smaller SMEs, and other enhanced strategies that maximise development outcomes for medium-sized companies should be considered. Further studies that examine how other characteristics of SMEs, such as their years of operation influence SME development is recommended.

Keywords: Contractor Development, Integrated Procurement, Management Procurement, SMEs, Traditional Procurement

1. INTRODUCTION

A small and medium enterprise (SME) is usually defined by the number of employees of a firm and the value of sales and assets (Fischer and Reuber, 2000). However, the size/classification of SMEs differs between countries. This study will use the definition provided by the South African National Small Business Act, No. 102 of 1996, which defines a small business by the number of full-time employees, total annual turnover, and the gross asset value excluding fixed property (Republic of South Africa, 1996). The amended National Small Business Act of 2003 categorises SMEs in the construction industry in the following classes: medium, small, very small and micro, based on certain characteristics such as the total full-time paid employees being less than 200, 50, 20 and 5, and total turnover of each class of less than R26m, R6m, R3m and R0.20m respectively (Republic of South Africa, 2003).

In low-income countries, SMEs and informal enterprises contribute over 60% of GDP and over 70% of total employment, while in middle-income countries they contribute 70% of GDP and 95% of total employment (Kongolo, 2010). In South Africa, SMEs account for over 34% of total GDP and about 66% of total employment (Berry *et al.*, 2002). SMEs are vital to the economy as a source of job creation and poverty alleviation (Schüssler, 2012). However, due

to their size, SMEs are often faced with challenges that hinder their development including, lack of funding, access to finance and poor managerial skills (Stefanović *et al.*, 2009), regulatory constraints, limited purchasing power, and access to international markets (Abor and Quartey, 2010). Research also shows that there is high failure rate amongst SMEs, of which South Africa has one of the lowest survival rates compared to global SMEs (Mahembe, 2011). Small contractors in the construction industry must compete with the established large firms for contracts (Storey, 2004). According to Storey (2004), the removal of these constraints fosters SME development. Watermeyer *et al.* (2001), states that to address such constraints relating to the demand for projects/job opportunities by SMEs, procurement interventions that provide access to the markets are needed.

The development of contractors from historically disadvantaged communities began in the mid-1980's in South Africa and had evolved. Watermeyer *et al.* (2001) established that many contractor development frameworks with different development philosophies evolved from these initiatives. The government has placed a plethora of preferential procurement strategies in place for the development of SME contractors via targeted development programmes for the potentially emerging contractors such as unbundling of projects and giving preferences to large contractors who enter into joint ventures with SME contractors (cidb, 2005). Contractors who are prioritised can overcome constraints such as access to markets, skills, finance and supportive institutional arrangements through a developed system of procurement referred to as targeted procurement.

Despite the ongoing implementation of these so-called 'SME-friendly' policies, tendering remains highly problematic for SMEs in the public procurement policy landscape. According to Kidalov and Snider (2011), the very existence of the 'SME-friendly' policies is the cause for the failing market. The assumption of homogeneity across the SME population has led to the imposition of 'SME-friendly' policies on the SME population without consideration that it might impact the SMEs depending on their size (Flynn *et al.*, 2013). Karjalainen and Kemppainen (2008) noted that the diversity among SMEs is often overlooked and presented to have shared similar objectives, possessing the same capabilities and facing challenges of equal magnitude. This stance motivates this research to take a view beyond the generalisation of SME development and explore whether there is a variation in the influence of procurement strategies across SME population based on their size.

2. OVERVIEW OF PROCUREMENT STRATEGIES

Procurement strategies can be seen to encompass the organisational structure and a process that a client adopts for managing the design and construction of a building project (Lee, 1998). Masterman (2003) further adds to this by stating that at times operation of the completed project could need a procurement strategy. Akram *et al.* (2012) acknowledge that a good procurement strategy will find an optimum balance between the organisational strategy required and individual projects. The selection of the ideal procurement strategy is necessary because it plays a major role in defining the contractual and functional/work relationship between the parties that are to take on a project (Masterman, 2003). Figure 1 illustrates the separation of the various procurement strategies and their subdivisions.

2.1 Traditional procurement strategy

The traditional method of procurement is the oldest form of procurement in the construction industry (Mathonsi and Thwala, 2012). In the traditional method of procurement, the client enters into an agreement with the design team (an engineer or architect) to prepare all the pre-tender documents (Lee, 1998) and upon the completion of the tender document, the client appoints a contractor to carry out the works (Davis *et al.*, 2008). Notably, the traditional strategy has classifications that separate the functions of design and construction (Mfongeh, 2010; Windapo and Rotimi, 2012) where two different entities (design and construction) enter into various contracts with the client (Mathonsi & Thwala, 2009). The variants of the traditional procurement strategy are the lump sum, measurement contracts and cost reimbursement. Despite much criticism from the construction industry, the traditional procurement strategy continues to be the most widely used in public procurement due to its accountability and transparency feature (Molenaar and Songer, 1998; Hashim *et al.*, 2006; Jayasuriya and Rameezdeen, 2010).

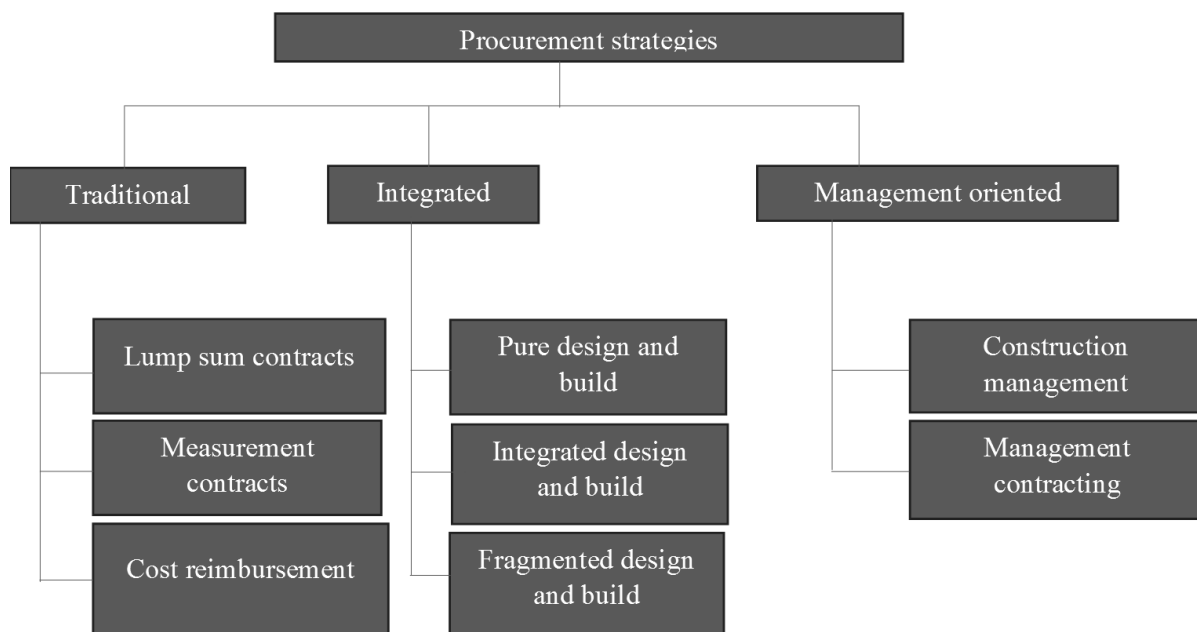

Figure 7: Categories of procurement strategies (Source: Davis *et al.* (2008))

2.2 Integrated procurement strategy

In integrated procurement strategy, the client deals with one organisation that executes both the design and construction of the project, thus having a single point of responsibility. The close integration of design and construction phases reduces cost as the contractor's knowledge and expertise can offer the client price competition as well as inherent buildability at an early stage. Saxon (2000) argued that time and cost overruns are better managed in an integrated system. However, an integrated system poses new contentious issues the client may not have a chance to deal with (Lee, 1998). Noteworthy is the high design/quality risk associated with this approach as the contractor develops the design. Some variant strategies that can be defined under the integrated procurement strategy include design and build, build operate and transfer, a public-private partnership, private finance initiative, and package deal or turnkey procurement.

2.3 Management oriented procurement strategy

The client appoints a construction/project manager who professionally manages, develops a programme and coordinates the design and construction activities in the management procurement strategy. The construction/project manager also facilitates the collaboration of the different trade contractors that are appointed by the client to ensure that they work smoothly and efficiently together (Akram *et al.*, 2012; Davis *et al.*, 2008). With the complexity of building structures, the management oriented procurement strategy is seen as the best form of procurement (Lee, 1998) because much of the design and control rests on the specialist. There are variant forms of management procurement systems which include management contracting, construction management and design and manage (Davis *et al.*, 2008).

3. MEASURING SME GROWTH AND SME CLASSIFICATION BY SIZE

Coad and Hölzl (2010) note that there are two basic approaches to measuring company growth; the absolute or relative, where the measure of absolute growth examines the actual change in firm size. From the change-in-size perspective, growth has been measured with a range of different indicators in literature, the most commonly used being sales, employment, assets, physical output, market share, and profits (Delmar, 1997). Measurement of growth is heterogeneous since it can be viewed from different perspectives. However, Teruel-Carrizosa (2006) argue that the number of employees is one of the widely-used indicators since it is less volatile than sales and it is not as rigid as physical output or productive capacity. Furthermore, according to Davidsson *et al.* (2005), more accurate measures are conceivable for specific industry studies. In construction, an increase in turnover and employment are the most frequently used by scholars in construction management research (Abu Bakar *et al.*, 2011, 2012; Ofori and Chan, 2000; Tucker *et al.*, 2015).

This study adopts multiple qualitative and quantifiable indicators of growth and aggregation of a firm's post-entry performance in relation to government and SME development objectives, namely: turnover, profitability, asset growth, increase in employment size, market share, managerial skills, community empowerment, creation of economic activities, exposure, advancement on cidb Register of Contractors (RoC), workforce training, and innovation and technology. In line with Teruel-Carrizosa's (2006) argument that a number of employees are the most stable variable at which to measure firm growth, the number of employees will be used to classify SMEs by size. According to the classification of construction SMEs by the amended National Small Business Act of 2003 in South Africa; a micro enterprise employs no more than five employees, a very small enterprise employs between 6 to 20 employees, 21 to 50 for a small enterprise, and 51 to 200 for a medium-sized enterprise.

4. CONCEPTUAL FRAMEWORK

Many theories have been used to show the relationship between firm size and firm growth rate. The most famous theory of a company's growth is Gibrat's law of proportionate growth or Law of Proportionate Effect, which states that firm growth is independent of the enterprise's size (Mansfield, 1962). However, scholars have rejected Gibrat's law, for instance, Vlachvei and Notta (2008) argue that this model does not apply to small firms, but it might apply to large companies. Also, Evans (1987) reported that firm survival increases with increase in firm size and age. Based on these theories on the relationship between firm growth rate and firm size, a

conceptual framework is proposed showing the relationship between procurement strategies (independent variable) and SME development (dependent variable). This relationship is mediated by SME size as an intervening variable (see Figure 1). The constructs for SME development are turnover, profitability, asset growth, an increase in employment size, market share, managerial skills, community empowerment, the creation of economic activities, exposure, advancement on cidb RoC, workforce training, and innovation and technology. The constructs for procurement strategies are traditional procurement, integrated procurement, and management-oriented procurement. While SME size is classified into micro, very small, small and medium enterprise.

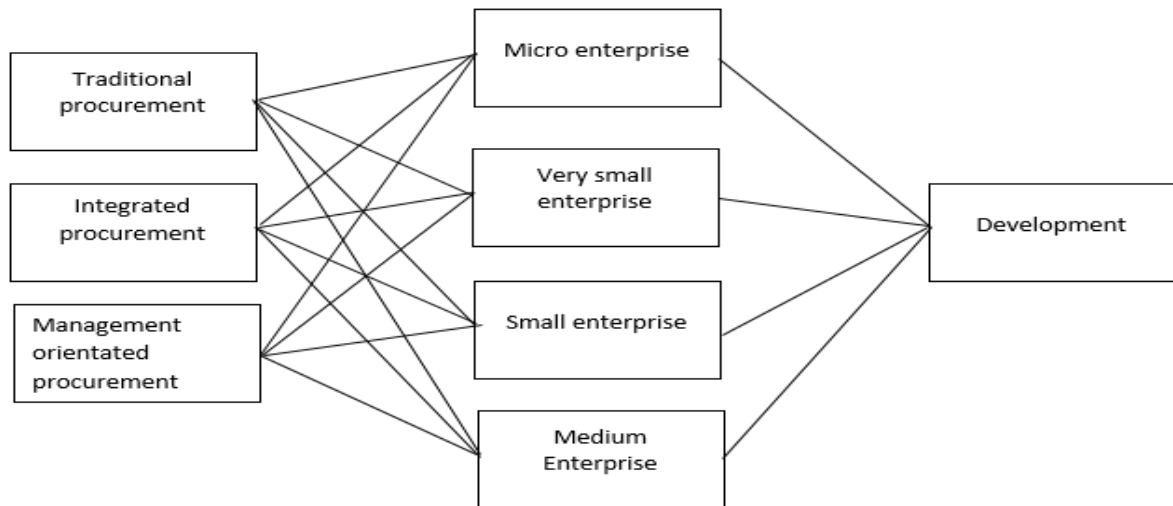

Figure 8: Conceptual framework

Based on the conceptual framework presented in Figure 1, the study proposes that procurement strategies will maximise SME development based on SME size.

5. RESEARCH METHOD

The study employs a quantitative research approach adopting a questionnaire survey in collecting empirical data from SME contractors. The sample size of the study consisted of 5,016 Grade 1-6 contractors randomly selected from the cidb Register of Contractors. 1,690 respondents accepted the invitation to participate in the survey. However, at the end of the survey period, 171 responses were obtained, which translates into a 10.1% response rate. The questionnaire survey gathered information about the SME's experience participating in public sector contracts and the performance of the SMEs at an organisational level.

The respondents were asked to indicate the type of procurement strategy used on an identified public sector project. They were also requested to rate the degree of achievement of SME development goals using a five-point Likert scale ranging from 1 (not achieved) to 5 (significantly achieved). Information was also collected on the SME's turnover, and number of employees using a five-point Likert scale based on the classification for construction SMEs by the National Small Business Act 2003. The data obtained were analysed using descriptive and inferential statistics – means, frequencies, charts and the Kruskal-Wallis H test.

6. DATA PRESENTATION AND FINDINGS

The data collected through a cross-sectional questionnaire survey are analysed and presented in the following sub-sections.

6.1 Background profile of respondents

The respondents' background profile provides a better understanding of the category into which the respondents fall based on their professional and work experience. Table 1 shows the distribution of the respondents by their profession, designation in the company and the organisation the respondent represents. The data obtained indicated that 31% of the respondents were construction managers, 13.5% were project managers, 11.1%, 8.8%, 0.6% were quantity surveyors, engineers, and architects respectively. A further 35.1% were other professionals such as human resources personnel, working in the construction company surveyed.

In their various designations, 61.4% of the respondents were directors, 18.7% were Chief Executive Officers, and 8.8% were in the management cadre, while 11.1% indicated other designations such as sole proprietors and owners. Regarding company sizes, 43.9% of the respondents are from a microenterprise, 31.6% are from very small, 12.3% small, and 8.8% are from medium-sized enterprises. Table 1 also reveals that half (50%) of the respondents have less than ten years' work experience in the construction industry, 25% had 11-20 years' experience, and another 25% had more than 20 years' of experience. Since half of the respondents (50%) have more than ten years of experience in the construction industry, it can be inferred that the respondents are knowledgeable enough to provide valuable insight into the operations of small and medium businesses in the construction sector which is relevant to this study.

Table 9: General profile of the respondents

	Frequency (N)	Percentage (%)
Construction industry experience		
< 5 years	42	24.6%
5-10 years	44	25.7%
11-15 years	22	12.9%
16-20 years	21	12.3%
> 20 years	42	24.6%
Profession		
Other	60	35.1%
Construction manager	53	31.0%
Project manager	23	13.5%
Quantity Surveyor	19	11.1%
Engineer	15	8.8%
Architect	1	0.6%
Designation		
Director	105	61.4%
Chief Executive Officer	32	18.7%
Management cadre	15	8.8%
Others	19	11.1%
Type of organisation		

	Frequency (N)	Percentage (%)
Micro	75	43.9%
Very small	54	31.6%
Small	21	12.3%
Medium	15	8.8%
Government	6	3.5%

6.2 Type of project and procurement strategy used

The study sought to determine the procurement strategy used post-2010 by public sector clients on projects in which the intention is to develop SME contractors. The result is presented in Table 2 and shows that traditional procurement was the most used procurement strategies by public sector clients, followed by management oriented and integrated strategies. Table 2 also indicates that the main type of projects reported on is residential followed by commercial projects.

Table 10: Distribution of procurement strategy used by public sector clients

	Frequency	Percentage (%)
Procurement strategy used		
Traditional	63	36.8
Integrated	42	24.6
Management oriented	43	25.1
Others	23	13.5
Type of project		
Residential	51	29.8
Commercial	34	19.9
Institutional	27	15.8
Industrial	23	13.5
Others	36	21.1

6.3 Level of achievement of SME business development goals on the identified projects

Table 3 shows the level in which the aspirations set by the SMEs were achieved on the identified public sector projects they executed, in relation to the type of procurement strategy used on the project.

Table 11: Mean ranking of the achievement of SME business development goals

SME business development goals	Procurement systems							
	Traditional		Integrated		Management		Overall	
	Mean score	Rank	Mean score	Rank	Mean score	Rank	Mean score	Rank
Community empowerment	3.077	1	2.676	2	2.951	1	2.902	1
Managerial skills	2.980	3	2.727	1	2.950	2	2.886	2
Creation of economic activities	3.000	2	2.226	6	2.829	4	2.685	3
Exposure	2.941	4	2.188	7	2.875	3	2.668	4

Advancement on cidb								
RoC	2.296	11	2.667	3	2.780	5	2.581	5
Work force training	2.615	6	2.313	5	2.575	6	2.501	6
Increase in employee size	2.347	10	2.344	4	2.487	7	2.393	7
Innovation and technology	2.510	8	2.167	8	2.421	8	2.366	8
Turnover	2.800	5	1.800	11	2.410	9	2.337	9
Profitability	2.608	7	1.939	9	2.405	10	2.318	10
Asset growth	2.396	9	1.700	12	2.385	11	2.160	11
Market share	2.115	12	1.857	10	2.184	12	2.052	12

Result from Table 3 reveals that traditional procurement led to the achievement (> 2.75 mean score) of community empowerment, creation of economic activities, managerial skills, exposure, and turnover; while integrated strategy led to the achievement (> 2.50 mean score) of managerial skills, community empowerment and advancement on the cidb Register of Contractors (RoC). Management oriented strategy led to the achievement (> 2.75 mean score) of community empowerment, managerial skills, exposure, the creation of economic activities, and advancement on cidb RoC. Overall, the top three SME business development goals achieved on the identified projects were community empowerment, managerial skills, and the creation of economic activity.

6.4 Influence of procurement strategies on SME development goals based on SME sizes

Figure 3 shows the achievement of SME business development in relation to the procurement strategy used and the size of SMEs. Figure 3 illustrates that increase in the level of achievement of SME business development goals on the identified projects is directly proportional to the growth in SME size from micro enterprises through very small businesses to small businesses i.e. small-sized enterprise generally experienced higher development compared to micro and very small businesses regardless of the type of procurement strategy used. However, medium-sized enterprises experienced lower development compared to micro, very small and small companies when traditional procurement strategy was used. When management procurement strategy is used, medium-sized enterprises experienced lower development compared to small-sized enterprises, but higher than micro and very small-sized enterprises. There were no medium-sized enterprises on projects where integrated procurement strategy was used. Figure 3 also shows that integrated procurement strategy saw the highest aggregate level of SME development among the different SME sizes. However, small enterprises developed better across all three types of procurement strategy.

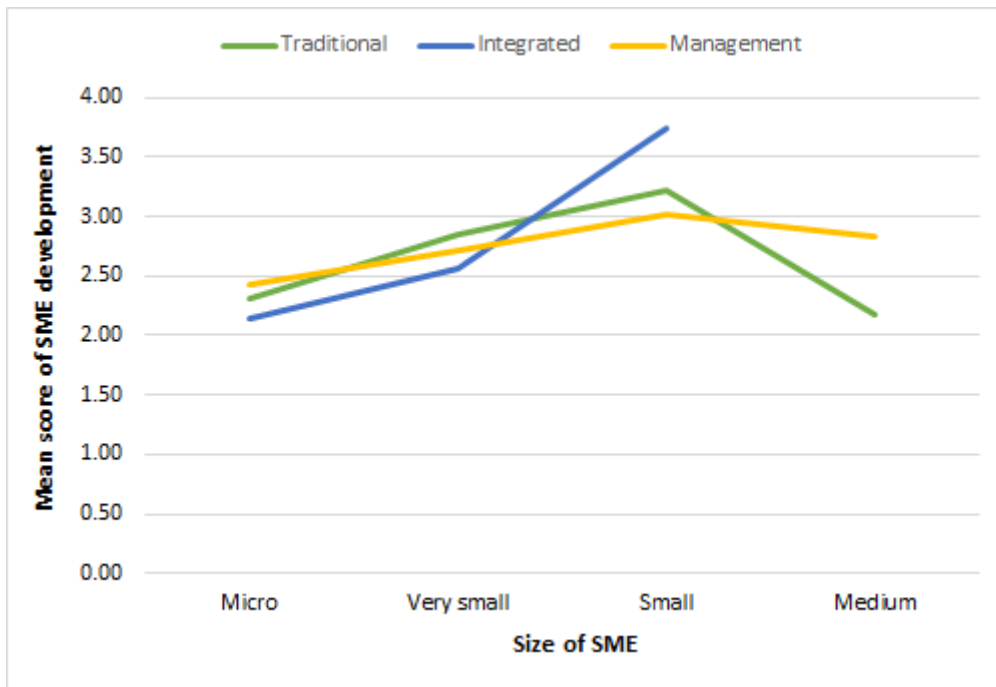

Figure 9: Achievement of SME business development goals in relation to the procurement strategy used and the size of SMEs

6.5 Distribution of SME development goals for SME sizes/groups in relation to the procurement strategy used

The Kruskal-Wallis H test was used to investigate any differences in the achievement of SME development goals (measured on an ordinal scale from ‘not achieved’ to ‘significantly achieved’) in micro, very small, small and medium-sized SME groups. The Kruskal-Wallis H test was chosen as the appropriate nonparametric alternative to a one-way ANOVA because the data violated some of the assumptions required for a one-way ANOVA e.g. the continuous dependent variable requirement (Kruskal and Wallis, 1952; Sheskin, 2011; Zar, 2010). The null hypothesis (H_0) stated to guide the Kruskal-Wallis H test is as follows:

H_0 : the distribution/mean ranks of SME development goals for SME sizes/groups are equal

Before carrying out the Kruskal-Wallis H test, the data was split into three according to the type of procurement strategy used (i.e. traditional, integrated and management-oriented) for easy interpretation. Furthermore, as a rule of thumb, a box plot was used to visually check whether the shape of the distributions of SME development goals is similar for the different SME sizes/groups (Vargha and Delaney, 1998). A visual assessment of the boxplot showed that distributions of SME development goals were not similar for all groups, except advancement on the cidb RoC and work force training scores which had similarly shaped distributions across the SME groups only when management-oriented procurement strategy was used. Inferences about differences in medians between SME groups should be made for observations with similar distributions while differences in distributions and mean ranks will be inferred from observations with different shaped distributions (Vargha and Delaney, 1998). The result of the Kruskal-Wallis H test is presented in Table 4.

Table 4: Kruskal-Wallis H statistics for distribution of SME development goals in different SME sizes/groups in relation to the procurement strategy used

SME development goals	Traditional Procurement			Integrated Procurement			Management-oriented Procurement		
	H (χ^2)	df	Sig. (p)	H (χ^2)	df	Sig. (p)	H (χ^2)	df	Sig. (p)
Community empowerment	3.251	3	.354	1.537	1	.215	.365	3	.947
Managerial skills	4.168	3	.244	1.913	2	.384	.985	3	.805
Creation of economic activities	2.834	3	.418	.061	1	.805	.556	3	.906
Exposure	2.851	3	.415	.040	1	.841	3.656	3	.301
Advancement on cidb RoC	8.901	3	.031*	1.088	2	.580	2.602	3	.457
Work force training	6.214	3	.102	2.903	2	.234	4.866	3	.182
Increase in employee size	10.563	3	.014*	3.035	2	.219	5.637	3	.131
Innovation and technology	4.673	3	.197	.208	1	.649	.685	3	.877
Turnover	6.115	3	.106	.154	1	.695	4.210	3	.240
Profitability	2.096	3	.553	.430	1	.512	3.748	3	.290
Asset growth	8.952	3	.030*	.592	1	.442	3.228	3	.358
Market share	7.163	3	.067	.690	1	.406	2.713	3	.438

*. $p < .05$.

H = Kruskal-Wallis H Test Statistic; df = degrees of freedom, which is $k - 1$ (where k = number of groups)

The Kruskal-Wallis H test result presented in Table 4 shows that the distributions or mean ranks of all SME development goals were not statistically significantly different ($p > .05$) between SME sizes/groups when integrated and management-oriented procurement strategies are used. Hence the null hypothesis is retained. When traditional procurement strategy was used, the distributions or mean ranks of SME development goals were not statistically significantly different ($p > .05$) between SME sizes/groups, except for Advancement on cidb RoC [$\chi^2(3) = 8.901, p = .031$], Increase in employee size [$\chi^2(3) = 10.563, p = .014$] and Asset growth [$\chi^2(3) = 8.952, p = .030$] which were statistically significantly different between SME sizes/groups; hence the null hypothesis is rejected and the alternative hypothesis will be accepted. This implies that different sizes of SMEs progress differently on the cidb RoC, and growth in assets and number of employees is not uniform across SME sizes when traditional procurement strategy is used. However, it can be inferred from the result that SMEs do not achieve development goals differently based on size, as indicated by the majority of the H statistics that showed no statistically significant difference.

7. DISCUSSION OF FINDINGS

Findings emerging from this study suggest that traditional procurement was the most used procurement strategies by public sector clients, followed by management oriented and integrated strategies. This finding is aligned with previous studies by Rwelamila and Meyer (1999), Grobler and Pretorius (2002) and Mbanjwa and Basson (2003), who found that Southern Africa utilises traditional procurement more often than other procurement systems on construction projects. The study also found that integrated procurement strategy saw the highest aggregate level of achievement of SME development goals among the different SME sizes. This is aligned to the findings of Watermeyer (2000) and Lahdenperä (2012) who established that the integrated procurement strategy which incorporates the characteristics of the development model of the World Bank is more applicable for small scale contractors' development as the risks and responsibilities are shared amongst the parties and not absorbed by only the micro enterprises. The study further revealed that SME development increases

proportionally to the growth in SME size from micro enterprises through very small businesses to small businesses, regardless of the procurement strategy used. This is aligned to Hart and Oulton's (1996) study who reported a positive relationship between firm growth and size among small businesses. However, the choice of procurement strategy did not lead to a statistically significant difference in SME development among the different SME sizes as indicated by the majority of the H statistics that showed no statistically significant difference. The results also suggest that smaller enterprises consistently develop and benefit the most from public sector contractor development initiatives compared to medium-sized enterprises. These findings suggest that procurement interventions and the size of construction companies do not interact in the optimum achievement of business development goals except where the preferred choice of procurement strategy – the traditional project procurement is used; hence, this has implications for the policies enacted by the government to target contractor development in South Africa.

8. CONCLUSION

The study examines the procurement strategies used by public sector clients on projects in which the intention is to develop SME contractors and whether the strategy used influences contractor development. The study found that traditional procurement was the most used procurement strategy by public sector clients. However, integrated procurement strategy saw the highest aggregate level of SME development, particularly among small SMEs. Overall, medium enterprises experienced lower development. Based on these findings, it can be concluded that there is a slight mismatch between the preferred choice of procurement strategy – the traditional project procurement approach and SME development outcomes for different SME sizes, and that the achievement of SME development has little to do with preferences or the use of particular procurement strategies and nothing to do with the size of SMEs except where traditional project procurement is used. It is therefore recommended that that public sector clients should not entirely treat SMEs as a homogenous block when using traditional project procurement; the use of integrated procurement strategies may be promoted for smaller SMEs, and other enhanced strategies that maximise development outcomes for medium-sized companies should be considered. Further studies that examine how other characteristics of SMEs, such as the influence of their number of years in operation on SME development is recommended.

9. ACKNOWLEDGEMENT

Funding from the National Research Foundation (NRF) towards this research is hereby acknowledged. Opinions expressed and conclusions arrived at, are those of the authors and are not necessarily to be attributed to the NRF. The authors also acknowledge the assistance of the following people in conducting the survey: Nthabiseng Mahloko, Mphosi Thakaso and Daniel Masuba.

10. REFERENCES

- Abor, J. and Quartey, P. (2010). Issues in SME Development in Ghana and South Africa. *International Research Journal of Finance and Economics*, 39(39), 218–228.
- Abu Bakar, A. H., Abdul Razak, A., Yusof, M. N. & Abdul Karim, N. (2011). Factors determining growth of companies: A study on construction companies in Malaysia. *African Journal of Business Management*, (5),

8753-8762.

- Abu Bakar, A. H., Tabassi, A. A., Abd. Razak, A. & Yusof, M. N. (2012). Key factors contributing to growth of construction companies: A Malaysian experience. *World Applied Sciences Journal*, 19(9), pp. 1295-1304.
- Akram, S., Cavallini, C., Dizdar, A., Mukherjee, A., Kluczuk, P., Kujawa, Z., Massarini, L., Michałowski, A., Nicał, A. and Nowak, P. (2012) *Manual – Procurement Strategy In Construction*. Leonardo Da Vinci Tol Project, European Commission.
- Berry, A., von Blottnitz, M., Cassim, R., Kesper, A., Rajaratnam, B. and van Seventer, D.E. (2002) The economics of SMMEs in South Africa. Trade and Industrial Policy Strategies, Johannesburg, South Africa.
- cidb (2005) *Best Practice Guideline A8: Procurement Measures to Develop Registered Contractors*. Pretoria, South Africa: Construction Industry Development Board.
- Coad, A. and Hözl, W. (2010) Firm growth: empirical studies. *WIFO Working Paper 361*.
- Davidsson, P., Achtenhagen, L., & Naldi, L. (2005). Research on small firm growth: A review. *European Institute of Small Business*, pp. 1–27.
- Davis, P.R., Love, P.E.D., and Baccarini, D., (2008). *Building Procurement Selection Review*. Report No. 1 For the CRC in Construction Innovation. Australia.
- Delmar, F. (1997). Measuring growth: Methodological considerations and empirical results. In R. Donckels & A. Miettinen (Eds.), *Entrepreneurship and SME Research: On its Way to the Next Millennium*, pp. 190-216. Aldershot, UK and Brookfield, VA: Ashgate.
- Evans, D.S. (1987) The Relationship Between Firm Growth, Size, and Age: Estimates for 100 Manufacturing Industries. *The Journal of Industrial Economics*, 35(4), 567-581.
- Falkena, H., Abedian, I., Von Blottnitz, M., Coovadia, C., Davel, G., Madungandaba, J., Masilela, E. and Rees, S. (2001) SMEs Access to Finance in South Africa—A Supply-Side Regulatory Review by the Task Group of the Policy Board for Financial Services and Regulation. In: Internal Report. November.
- Flynn, A., McKeivitt, D.M. and Davis, P. (2013) The impact of size on small and medium-sized enterprise public sector tendering. *International Small Business Journal*, 33(4), pp. 443-461.
- Grobler, K. and Pretorius, L. (2002). An Evaluation of Design-Build as a Procurement Method for Building and Civil Engineering Projects in South Africa. *Journal of the South African Institution of Civil Engineering*, 44(1), pp.13-19.
- Hart, P. E., and Oulton, N., (1996) Growth and Size of Firms, *The Economic Journal*, 106(438) pp. 1242-1252
- Hashim, M., Chan, M.Y.L., Ng, C.Y., Ng, S.H., Shim, M.H. and Tay, L.Y. (2006) Factors influencing the selection of procurement systems by clients. In *International Conference on Construction Industry 2006, Padang, Indonesia*.
- Jayasuriya, S. and Rameezdeen, R. (2010) Construction Procurement Selection: Comparative Study of Routine Projects vs. Disaster Reconstruction Projects. In *International conference on building resilience: Interdisciplinary approaches to disaster risk reduction, and the development of sustainable communities and cities, At Kandalama, Sri Lanka*.
- Karjalainen, K., and Kempainen, K. (2008). The involvement of small and medium-sized enterprises in public procurement: Impact of resource perceptions, electronic systems and enterprise size. *Journal of Purchasing and Supply Management*, 14(4), 230-240.
- Kidalov, M., and Snider, K. (2011) U.S. and European public procurement policies for small and medium-sized enterprises (SME): a comparative perspective. *Business and Politics*, 13(4), 1-41.
- Kongolo, M. (2010) Job creation versus job shedding and the role of SMEs in economic development. *African Journal of Business Management*, 4(11), 2288.
- Kruskal, W. H., and Wallis, W. A. (1952). Use of ranks in one-criterion variance analysis. *Journal of the American Statistical Association*, 47(260), 583-621.
- Lahdenperä, P. (2012) Making sense of the multi-party contractual arrangements of project partnering, project alliancing and integrated project delivery. *Construction Management and Economics*, 30(1), 57-79.
- Laryea, S. (2013) Factors constraining the development of professional project managers in small and medium-sized construction enterprises in South Africa. The University of Witwatersrand Johannesburg.
- Lee, K. (1998) The traditional procurement method: the choice of Hong Kong private sector clients for residential projects. HKU Theses Online (HKUTO).
- Mahembe, E. (2011) *Literature review on small and medium enterprises' access to credit and support in South Africa*. Underhill Corporate Solutions. National Credit Regulator (NCR): Pretoria, South Africa.
- Mansfield, E. (1962) Entry, Gibrat's law, innovation, and the growth of firms. *The American Economic Review*, 52(5), 1023-1051.
- Masterman, J. (2003) *An introduction to building procurement systems*. Routledge.
- Mathonsi, M., and Thwala, W. (2009). *Investigation of Factors That Influence the Selection of Procurement Systems of the South African Construction Industry*.
- Mathonsi, M. D, and Thwala, W. D (2012). Factors influencing the selection of procurement systems in the South African construction industry. *African Journal of Business Management*, 6(10).

- Mbanjwa, S. and Basson, G. (2003). *The Use and Effectiveness of Construction Management as a Building Procurement System in the South African Construction Industry*. Unpublished Masters Thesis, University of Pretoria.
- Mfongeh, N. (2010). *The constraints of using design and build for the procurement of construction projects in South Africa*. Unpublished Masters Thesis. The university of the Witwatersrand.
- Molenaar, K.R. and Songer, A.D. (1998) Model for public sector design-build project selection. *Journal of Construction Engineering and Management*, 124(6), 467-479.
- Ofori, G., & Chan, S. L. (2000). Growth Paths of Construction Enterprises in Singapore. *Engineering, Construction and Architectural Management*, 7(3), 307-321.
- Republic of South Africa (1996). National Small Business Amendment Act No. 102 of 1996. *Government Gazette*.
- Republic of South Africa (2003). National Small Business Amendment Act No. 26 of 2003. *Government Gazette*.
- Rwelamila, P. and Meyer, C. (1999). Appropriate or Default Project Procurement Systems? *Cost Engineering*, 41(9).
- Saxon, R. (2000) Special report: Design and Build. *Architects' Journal*. 3 February.
- Schüssler, M. (2012). *The 11th UASA employment report. South Africa cannot afford South Africans*. Gauteng, South Africa.
- Sheskin, D. J. (2011). *Handbook of parametric and nonparametric statistical procedures (5th ed.)*. Boca Raton, FL: Chapman & Hall/CRC Press.
- Stefanović, I., Milošević, D. and Miletić, S. (2009) Significance and development problems of SME's in contemporary market economy. *Serbian Journal of Management*, 4(1), 127-136.
- Storey, D. (2004) Promoting entrepreneurship and innovative SMEs in a global economy: towards a more responsible and inclusive globalisation. In: Second OECD Conference of Ministers responsible for Small and Medium-sized Enterprises (SMEs), Istanbul.
- Teruel-Carrizosa, M. (2006). *Firm growth, persistence and multiplicity of equilibria: An analysis of spanish manufacturing and service industries*. Unpublished PhD Thesis, Universitat Rovira i Virgili.
- Tucker, G. C., Windapo, A. O., & Cattell, K. S. (2015). Exploring the use of financial capacity as a predictor of construction company corporate performance: evidence from South Africa, *Journal of Engineering, Design and Technology*, 13(4) 596-611.
- Vargha, A., and Delaney, H. D. (1998). Kruskal-Wallis test and stochastic homogeneity. *Journal of Educational and Behavioral Statistics*, 23(2), 170-192.
- Vlachvei, A. and Notta, O. (2008) Firm growth, size and age in Greek firms. In: *Proceedings of International Conference on Applied Economics 2008*, 915-921.
- Watermeyer, R. (2000) The use of targeted procurement as an instrument of poverty alleviation and job creation in infrastructure projects. *Public Procurement Law Review*, 226-250.
- Watermeyer R. B., Jacquet, A. and Noyana, C. (2001) Developing the Capacity of Targeted Enterprises in Contractor Development Programmes. In: *Regional Conference on Developing the Construction Industries of Southern Africa, Pretoria*.
- Windapo, A. and Rotimi, J. (2012). Determining project performance criteria and key procurement methods in Nigeria: Client's perspective. *Joint CIB W070, W092 & TG72 International Conference on Facilities Management, Procurement Systems and Public Private Partnership - Delivering Value to the Community*. Emerald, pp. 250-259.
- Zar, J. H. (2010). *Biostatistical Analysis (Fifth Edition)*. Pearson Educational.

**W102: INFORMATION AND KNOWLEDGE MANAGEMENT
IN BUILDING**

CONSTRUCTION INDUSTRY NEEDS AN AIRBNB OF ITS OWN!

Otto Alhava¹, Enni Laine² and Arto Kiviniemi³

¹ *Fira Oy, Finland*

² *Department of Civil Engineering, Aalto University, Finland*

³ *School of Architecture, University of Liverpool, United Kingdom*

Email: otto.alhava@fira.fi

Abstract: Platforms are disrupting businesses globally. Online technologies are powering up start-ups, which will grow in size, business volume, and stock value within a few years and strike down large companies. A platform business model is a disruptive force, and it is capable of sweeping aside traditional businesses which are using a legacy pipeline business model. The construction industry has survived the rage of platform companies so far, but it is expected that the platform business model will also appear in our industry, as it has already entered agriculture, energy and heavy industry, logistics and delivery, in addition to taxi and hotel business. The objective of this research is to explain the key differences of pipeline and platform business models and to evaluate the maturity of business models of the construction industry to understand the potential for industrywide disruption caused by the platform business model. In the context of the management research, this research concentrates to the market intermediary platforms. A concrete example of a platform business model is presented in a case study of Urakkamaailma.fi, which reveals that the platform business model is also applicable in the construction industry and there is a potential for disruption in the construction market.

Keywords: Business Model, Construction Industry, Disruption, Pipeline, Platform

1. INTRODUCTION

Platforms are the modern monopolies which will dominate the 21st-century economy (Moazed & Johnson, 2016). They will be the end of employment as the crowd-based capitalism will take over (Sundararajan, 2016). They are the matchmakers, who will redefine the economics and wreck the production-price-profit equation (Evans & Schmalensee, 2016). They are harnessing the excess capacity for the good of the mankind (Chase, 2015). They have even created the uber-worked and underpaid workers of the digital industry (Scholz, 2016).

Many industry sectors are being transformed by platform businesses, including agriculture, consumer goods, logistics and delivery, and even energy and heavy industry (Parker et al, 2016). But platforms have not conquered the construction industry, at least not yet. On the contrary, as the construction industry lags behind in the development of the conventional, customer value-driven business models (Pekuri, 2015). Even in the field of research, the business model knowledge in building and the construction industry seems to be far underdeveloped (Pan and Goodier, 2012). Under these circumstances, we should discover whether the platform business model is a threat or an opportunity for the construction industry. What is preventing the platform businesses in succeeding in the construction sector? What is the problem we are solving with the platform business model in construction business? Is there some entry barrier in construction industry which would explain why all the previous isms, like Lean construction and servitisation, have failed in finally starting the development of the productivity in our business? And finally, where is the leverage point of the construction industry? The journey to understand the answers to the questions above was begun by analysing the opportunities of a platform ecosystem business model for the construction industry (Laine et. al, 2017). The purpose of this research is to sum up the theory related to platform literature

from the market intermediary platform perspective and analyse its application through a case study of an existing company utilising the business model.

2. CONVENTIONAL BUSINESS MODEL

A business model seeks to explain both value creation and value capturing from a systemic perspective (Pan and Goodier, 2012). In conventional business models, companies create value by controlling a linear set of activities (Parker et al. 2016). These activities are used to build products or craft services for pushing them out and selling them to customers (Choudary, 2015). Traditionally, the activities of each company are described in a generic value chain model, shown in Figure 1., and they are divided to primary activities and support activities for designing, producing, marketing, delivering, and supporting the product or service of the company (Porter, 1998).

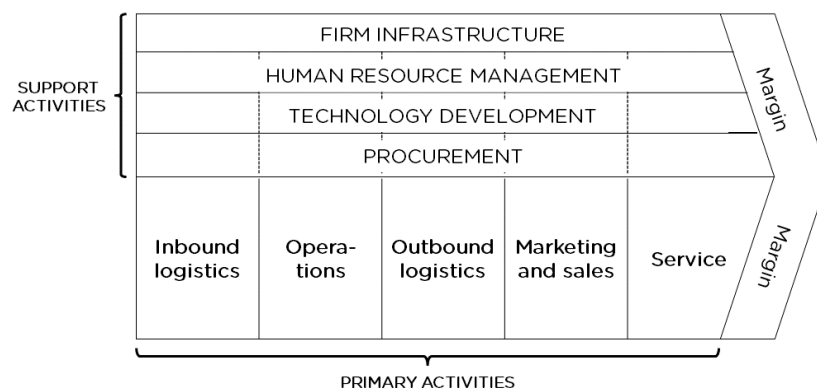

Figure 10: Generic value chain model of a company (Porter, 1998)

According to Osterwalder and Pigneur (2010), a business model describes the principle of how an organisation creates, delivers, and captures the customer value. In this context, the traditional business model can be seen as a linear movement of materials or data, to which value is added constantly until it is finally delivered to a customer (Choudary, 2015). The value chain model presents the company and supply chain as a subsequent chain of events or activities, and hence it can be called linear (Moazed and Johnson, 2016), single sided (Evans and Schmalensee, 2016), a pipeline (Parker et al., 2016), or, shortly, a pipe (Choudary, 2015) business model. Osterwalder and Pigneur (2010) also provide a framework of nine basic building blocks in their pre-structured business model canvas. However, it does not explicitly capture the success factors of platforms, but provides a generic framework to work with linear and non-linear businesses (Reillier and Reillier, 2017).

Moazed and Johnson (2016) claim that the value chain model provided businesses a method to systematically break down their organisation into a set of activities and to understand how they should build them up to achieve the most value for the least cost. As depicted in Figure 2., the traditional companies using pipeline business model will concentrate on outsourcing activities which are not their core competencies to the companies in their supply chain, and protecting these partners from their competitors if the transaction cost is low enough and they provide competitive advantage to the company. Purchasing practices should include promoting supplier and subcontractor cost reduction and technology development that lower the firm's cost (Porter, 1998), but also preventing competitors to benefit from these improvements by using exclusive contracts. Simultaneously, the company tries to develop internal resources and

intelligent properties and lower the costs of value creation process while it tries to improve the customer value produced by the process. A pipeline business employs a step-by-step process for creating and transferring value from companies at one end and customers at the other end (Parker et al., 2015). In summary, pipeline businesses compete through resource ownership and control (Choudary, 2016) and this is one of their weaknesses, as they easily became inefficient gatekeepers to manage the flow of value from the producer to the consumer (Parker et al., 2016).

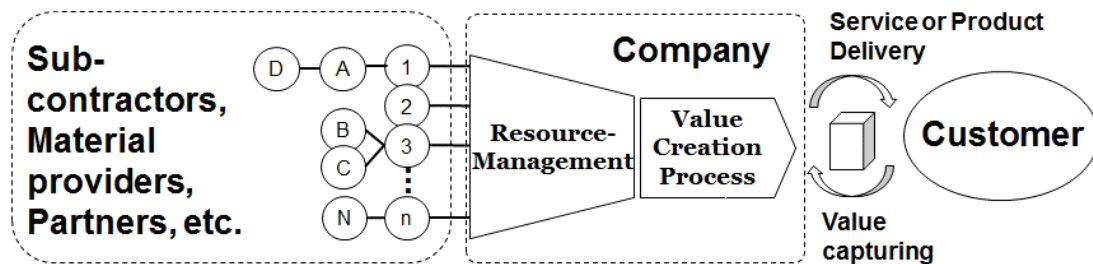

Figure 11: Proposed pipeline business model

Pipeline businesses focus on repeatable processes in which the value is created upstream and consumed downstream and they appear in nearly every area of modern industry (Choudary, 2015). In a pipeline business, value capturing relates directly to the pricing strategy, which in turn is mainly determined by a trade-off between volume and margin (Evans and Schmalensee, 2016).

2.1 Pipeline business model in construction industry

Business models in construction industry have not been studied or understood thoroughly. According to Pekuri (2015), the existing business models in construction industry are resource driven rather than customer focused. In practice, the business management focuses on securing the cash flow and continuous stream of projects to ensure a high resource utilization.

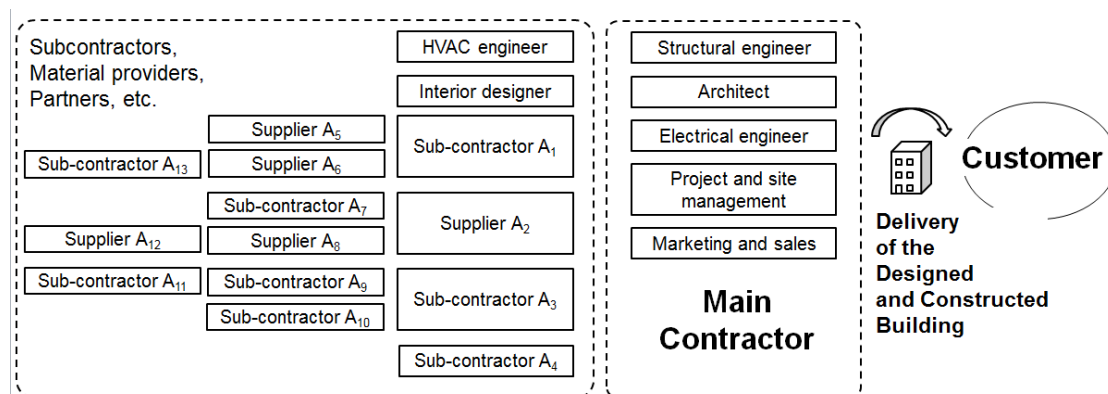

Figure 12: Design-and-build construction project in the context of the proposed pipeline business model

Additionally, the supply chain of the whole industry is fragmented (Dave et al., 2008) due to extensive use of competitive bidding in procurement and a tendency to split projects into smaller parts and specialized subcontractors to reduce the price of each individual subproject or task. An example of a design-and-build project in the context of the proposed pipeline business model is shown in Figure 3. Given the fact that main contractors have outsourced a relatively high proportion of projects to partners, material suppliers, and subcontractors, they

are not able to develop resource management nor their own primary or support activities as the set of subcontractors and suppliers changes from project to project.

Pekuri (2015) also suggests that the concepts of business model and business strategy are not well understood in construction companies, which then leads to difficulties in developing the business model and strategy of the company in long term. Although Pekuri's study of the construction industry business models was conducted in Finland, the results can be applied in larger extent due to the fact that two international companies were included in the interviews. These findings, which indicate certain immaturity in the implementations of business models, are aligned with the study of Loosemore (2014). Loosemore summarises the main determinants of low productivity for subcontractors to be: 1) the quality of relationships with principal contractors, 2) transparency of tender practices, 3) growing administration and document control, 4) design management, 5) project management, 6) risk management, and 7) industrial relations. Low productivity of subcontractors and its main determinants also clearly indicate that main contractors are neglecting opportunities to create value together with subcontractors and material suppliers in their value chain. This notion is further strengthened by Horner and Duff's (2001) analysis of 25 years of construction productivity, in which they concluded that there had been only very few changes to construction project management over the last 50 years, and that there is an improvement gap.

In order to understand the underlying mechanisms of the business environment in the construction industry, the business models should be also reviewed in the different levels of delivery chain and the review should concentrate on the subcontractors' business environment. Sacks (2016) indicates the economic imperative of reducing the risk of maintaining a directly employed workforce in a portfolio of projects, while the economical volatility is unpredictable. This imperative explains the high rate of outsourcing of construction work at the level of main contractors. However, as the development of procurement methods has stagnated, the competitive bidding is widely used in construction, in spite of its shortcomings (Elfving et al., 2005). Immature business models of both main and subcontractors are one source of waste in addition to the lack of trust, and the hostile environment of construction industry, which are described in Dave et al. (2010).

In the context of business model development, the situation is made even harder for management of the construction companies since the role of a construction company may vary from a subcontractor in one project to a main contractor in the next (Bygballe and Jahre, 2009). Elfving et al. (2005) also discuss the role of construction companies and the major impacts of the procurement model in project-based production. In the context of the subcontractors' business model, the procurement model has major impacts on other delivery phases such as design, manufacturing, and installation. These impacts seem to be much greater than the construction industry has generally perceived. One impact is the difficulties faced by subcontractors, whose business model includes overbooking of workforce. The reason for overbooking is the unreliable scheduling of individual projects which requires subcontractors to juggle the demands of multiple projects (Sacks and Harel, 2006). As a result of current environment and obstacles described above, the business model development of companies operating in the construction sector has not been very successful.

2.2 Consequences of business model implementation in construction industry

According to Porter (1998), the fundamental basis of company's performance and development in the long run is the sustainable competitive advantage. Even though there are a myriad of

differences in the strengths and weaknesses of a company's value chain in comparison to its competitors, there are two basic types of competitive advantage a company can possess: low cost or differentiation. In combination with the selection of the target customer group, three generic strategies can be provided: 1) cost leadership, 2) differentiation, and 3) focus on certain market segment (or market mix). In the domain of competitive bidding, it is relatively hard to find any other strategy and competitive advantage than low cost among the main and subcontractors of construction industry.

Because of the low interest to business model development, concentration to the lowest price tendering, and the lack of competitive strategies, the construction industry is very immature and strategically weak compared to other industries. Due to these weaknesses, the construction industry is potentially vulnerable to disruptions caused by companies with a modern business model from outside of the construction industry.

3. EMERGENCE OF PLATFORM BUSINESS MODEL

The term platform has both a metaphorical and a constructive role in management research, and serious efforts have been made to develop a coherent theoretical categorization to understand different types of platforms (Thomas et al, 2014). Some studies of platforms, e.g. Gawer and Cusumano (2013), concentrate on the technological perspective and consider platforms as a company-specific or industry wide business ecosystem in which complementary products, technologies, and services can be innovated and provided for customers. From the business model perspective, it is essential to understand why certain companies like Uber and Airbnb and their implementation of a platform business model is successful enough to cause disruption. Therefore, a matchmaking context is far more substantial for this study than a product or a technology perspective.

Armstrong (2006) gives examples of markets where two or more groups of agents interact via intermediaries or platforms, including yellow pages' directories and malls. Thomas et al. (2014) have taken the platform categorisation even further and define four archetypes of platforms. 1) Organisational stream, which consists of companies developing their internal capabilities - in this context the platform represents a collection or specific architecture of dynamic resources. 2) Product family stream, which represents both technical architecture of the product or service and the structure for delivering that product or service. 3) Market intermediary stream, in which the platform is an interchange between multiple markets, and finally, 4) platform ecosystem stream, in which the platform represents industry wide standards, modularity, and differentiation of product or service system, where the control is relinquished for the ecosystem instead of one platform owner. In Laine et al. (2017), we reviewed the platform ecosystem stream combining the product and market intermediary streams in the context of construction industry. In this study, we concentrate on the market intermediary platform stream (Thomas et al, 2014) and discuss multi- or two-sided platforms only.

In fact, companies and consumers have been connected by platform business models and created value together for ages, and therefore multisided businesses have existed in parallel with pipeline businesses for centuries - but it was only in 2000 when the first economists discovered and described them (Evans and Schmalensee, 2016). A traditional grocery store is single-sided as it buys goods from suppliers and resells them to its customers. A marketplace of a town is a two-sided platform in which food suppliers meet customers and interact directly

with each other (Evans and Schmalensee, 2016). The pioneering economic model was first described by Rochet and Tirole (2003), as they recognized that many markets are multisided and the platform in common may treat the other side as a profit centre and the other as a loss leader. The rise of the internet has led to a preoccupation with 'free' in relation with information and services already in the 1990s (Lennon, 1999), but traditional value chain and the pipeline business model are not able to explain why it is possible to sell something at less than its cost or even for free. A few years later, the digitalisation gave the platform business model the opportunity to minimise the transaction cost, which in turn started the age of platform with companies like Apple, Amazon, Facebook, and Google (Simon, 2013). Currently, a large number of companies using the platform business model are providing 'free' offerings to their customers, but as we know now, it is a strategic choice for either increasing the repeatability of interactions, or for capturing data, which can be monetised in their business later (Choudary, 2015). Currently, there are a number of competing and complementary definitions for the multisided platforms. Hagiu and Wright (2015) define that these platforms are organisations that create value by enabling direct interactions between two (or more) distinct sides, each of which is affiliated with the platform. Parker et al. (2016) include to the definition the open and participative infrastructure as well as the governance conditions for interactions. Evans and Schmalensee (2016) have broader approach as they highlight the importance of the matchmaking functionality and the role of internet as an enabler for platforms. More recently, Reillier and Reillier (2017) propose to define the platform businesses as a business creating significant value through the acquisition and/or matchmaking, interaction and connection of two or more customer groups to enable them to transact.

3.1 Disruption caused by platform business model

Powered by internet technologies, different platforms are entering new economic landscapes. The global assault of Uber on the taxi business and Airbnb on the hotel business are well known examples, and they will probably cause a terminal decline to traditional pipeline businesses (Evans and Schmalensee, 2016).

Parker et al (2016) explain the reasons behind the platforms' capability to both conquer and transform traditional industries. Firstly, (two-sided) markets are the most natural places for producers and consumers to meet and create value together. Secondly, the digital technology expands the reach, speed, convenience, and efficiency of the multisided platform enormously. Thirdly, the platform business model can be scaled with near-zero marginal costs as they are delinking company assets from value and value creation of producers and consumers. Fourthly, platforms have a capability to create new efficiencies by aggregating unorganized markets. This has a relation to the platform's capability to create a market for unused capacity, or as Chase (2015) expresses it, the abundant excess capacity. The driver of the scale is positive network effect, due to the fact that the value of the platform is typically increased for every existing participant as a new user joins it (Choudary, 2015).

Some platforms are being fuelled solely by excess capacity. BlaBlaCar makes an unused passenger seat available for travellers, and already by the end of 2015 more than 2 million people per month were traveling across Europe by getting rides in strangers' cars (Chase, 2015). Airbnb is a very similar example where a platform is brought to life by excess capacity of unused apartments. The second disruptive force of a platform is its ability to scale with near zero investment. By 2016, Airbnb had more rooms booked every night than the largest global hotel chains (Parker et al. 2016). Because of this leverage caused by the platform business

model, the number of platforms at the top of the global economy is growing fast and exponentially. Already in 2015 the top three members of Forbes’s list of most valuable brands were platform companies, and if the top twenty is examined, the total number of platform companies is eleven (Moazed and Johnson, 2016). The rise of the platform business model is causing transformations in a number of industries and in the society as a whole, not just in social media and high technology industry. The number of successful platform business model implementations increases, as new industries are being conquered, e.g. agriculture (John Deere), consumer goods (Philips), energy and heavy industry (Nest, Tesla Powerwall, General Electric), Health care (Cohealo), labor and professional service (Upwork), and retail (Alibaba, Amazon, Walgreens) (Parker et al. 2016). Platforms also harvest investments: as the S&P 500 companies were examined in 2014, the average revenue multiple of pure platform companies was 8.9, while the linear businesses are valued between two to four times revenue depending on their pipeline business model (Moazed and Johnson, 2016).

3.2 Key functionalities of platform business model

The anatomy of the two-sided platform can be simplified into basic set of functionalities. Choudary (2015) states that the very essence of platforms is to enable interactions between producers and consumers in which value and currency of some sort is exchanged. Exchanged currency can be money or social currency, e.g. attention, reputation, influence, or goodwill. In addition to interaction, the platform must enable matchmaking.

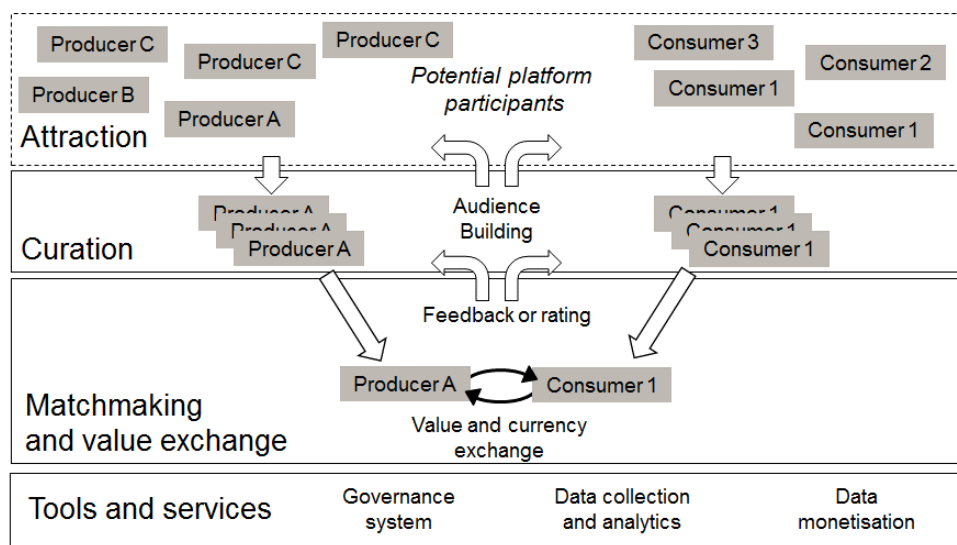

Figure 13: Basic functionalities of the proposed platform business model

Parker et al. (2016) model the core transactions of a platform with three steps, Pull - Facilitate - Match, whereas Moazed and Johnson (2016) define the core transactions as a “value factory”. The core transactions of this factory are 1) audience building, 2) matchmaking, 3) providing tools and services, and 4) setting rules and standards. Both models expect that the platform must attract consumers and producers to join and then aid the most suitable pairs of producer and consumer in finding each other. The basic set of functionalities of the platform business model is depicted in Figure 4. The matchmaking is typically enhanced with data collection and an extensive use of algorithms, but the platform must also aid in value transaction and secure both the exchange of information, assets, and in most cases, money (Choudary, 2015). The rules and standards of the platform are a part of the governance system, by which the platform

rewards those who exceed the expectations and similarly expels those who are behaving badly (Evans & Schmalensee, 2016).

3.3 Network effect and near-zero marginal cost

The value of the platform for each of its members is increased as a new member joins the platform. When a pipeline business gains a new customer it only adds one new relationship, one buyer more, but in a platform a new consumer can potentially have a relationship with any producer (Moazed and Johnson, 2016). Hence, the network effect of platforms is far more cost effective and more scalable than in pipelines, and their value tends to grow exponentially rather than the linear growth of pipeline businesses. Platform giants, such as Google Maps, are creating massive value and giving it away for free, or so it would seem. But if their business model is examined more closely, they either gain positive network effect or capture monetisable data by offering 'free' services.

According to Evans and Schmalensee (2016), there are in relation to the network effect three major drivers for multisided platforms: 1) efficient and relatively cheap hand held devices (especially smartphones), 2) low cost broadband access, and 3) cloud computing. Together these three drive the transaction cost in a multisided platform to minimum and provide means for maximising customer value by enabling matchmaking of producers and consumers

3.4 Curation and customer experience

Amazon has invested a great deal of effort in designing supreme user experience (Simon, 2013). As a result the shopping itself is easy: there are a number of localized delivery methods from which the customer can choose and the delivery is very precise and transparent. The whole customer journey is very enjoyable. In order to be successful, the platform owners must invest in behaviour design and customer curation, which represents an equivalent of loyalty programs in pipeline businesses (Choudary, 2015). Platforms remove friction and make interactions easy for participants, but they must also build trust between them (Evans and Schmalensee, 2016). Different types of reciprocal rating systems and voting mechanisms are trust creation mechanisms, but they have an important role in quality control as well as in matchmaking, as the platform collects, analyses, and shares information to increase the customer experience (Choudary, 2015). In essence, the platforms are very transparent and they compensate positive externality and punish negative ones (Evans and Schmalensee, 2016).

4. CASE STUDY – URAKKAMAAILMA.FI

This research is a case study addressing some aspects of the business model problem by investigating the opportunities of a platform business model used in real projects. The literature study did not reveal any companies from the construction industry which would use a platform business model in a project environment. Instead, three example companies were found by a web based search. The business model of each of these three, Construction Clean Partners (<https://constructioncleanpartners.com>), Urakkamaailma.fi and Renovate Simply Inc (<https://renovatesimply.com>), were studied and compared to the platform business model. Urakkamaailma.fi was chosen for this case study since it was considered to be the most relevant

example of the platform business model implementation and provide the most comprehensive set of platform business model features for the study.

Urakkamaailma.fi is a small Finnish company which uses the platform business model in matching households and small businesses who provide renovation services. The business model of Urakkamaailma.fi, which is depicted in Figure 5., is based on a relatively large base of contractors who are checked and qualified before they can join the platform. This background check is enhanced with a service provided by Tilaajavastuu.fi, which is a joint venture of the national construction industry. It provides services with which companies can comply with Finnish legislation and Contractor’s Obligations Act and the Tax Number Act. As these acts became effective in 2007, they meant an obligation for the clients to check the background of their suppliers. In the terms of platform business model, Urakkamaailma.fi uses both acts and Tilaajavastuu.fi as a governance system for contractors, which are the producers of the platform.

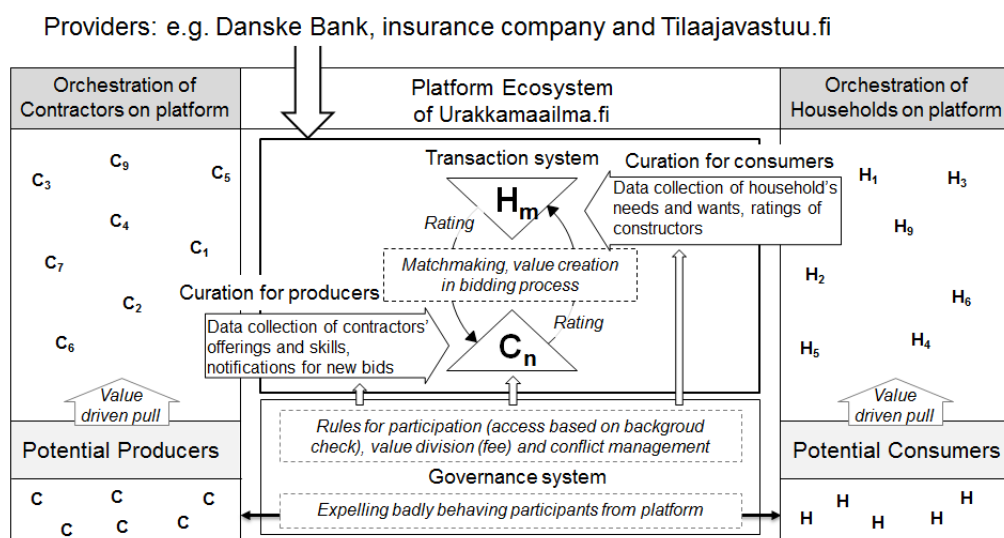

Figure 14: Platform business model of Urakkamaailma.fi modified from (Laine et al, 2017)

4.1 Transaction and value creation

The transaction process for consumers, i.e. the households, consists of three phases. Firstly, the household fills in an invitation for tenders to the platform, in which the need of renovation work is described. As the households are amateurs in defining the work, the platform has readymade templates for different types of household renovation projects. Secondly, the platform provides tools for bid comparison and tools to equalize the bids. Thirdly, Urakkamaailma.fi provides support in the contracting phase and to secure the transaction of value by providing legal aid for households in case of disputes or litigations. Among key partners of Urakkamaailma.fi is one of the major players in the Finnish banking sector, the Danske Bank, which provides financial services to the households seeking renovation service.

4.2 Attraction and curation for construction companies and households

Registration for the renovation and construction companies is free of charge. For a construction company, the platform provides an easy acquisition channel for new customers, since the

construction company can define the discipline/type of works and geographical area from which it will receive invitations from tenders automatically.

For households, Urakkamaailma.fi offers ratings of previous customers in addition to bid competition and a standard contract. The ratings and facilitated tendering process are the key benefits of the platform for the households since selection of a good contractor has traditionally been a difficult task due to the large variety of the offering in terms of quality and price. Additionally, the financial services, which the household can use directly from the platform can be seen as both value driven pull of potential consumers as well as curation for the existing households on the platform.

4.3 Analysis of the implemented platform model

Urakkamaailma.fi is a newcomer that has managed to solve the chicken-egg problem by attracting a relatively large number of contractors to register to their service. As the service is relatively new and the financial figures are not available, it is not possible to justify whether the platform has managed to reach breakeven or enough households for value capturing. Furthermore, the value capturing model is based on only a small percentage fee which is charged from the construction company winning the bidding; this makes the platform vulnerable to bypassing. Urakkamaailma.fi reports the value of tendered contracts in the second quarter of 2017 to reach 30 MEUR and the number of registered contractors to be over 5000. Growth rate and profitability figures are not available, and therefore it is not possible to validate how successfully the platform is gaining new customers and whether it has reached the positive network effect. However, the number of registered contractors is substantially high given the fact that the size of Finnish construction market is relatively small.

Urakkamaailma.fi has managed to connect a major bank and Finland's largest and most comprehensive digital registry to their platform as providers for providing more value to the consumers. They have also implemented rating system by which the consumers can evaluate contractors and their governance system is based on contractor's obligations and liability check via service of Tilaajavastuu.fi. In essence, Urakkamaailma.fi attracts both households and contractors to their platform, match them and provide them the capabilities for interaction. It also catalyzes the process by a cloud based system, which reduces the transaction cost of all participants.

5. THREAT OR OPPORTUNITY FOR CONSTRUCTION INDUSTRY?

The business models of construction industry are immature if compared to digitalised and more advanced industries. Since the value chains in construction industry have been very linear so far and companies are adhering to the pipeline business model, the industry is likely to follow the same steps of disruption that the other industries have gone through previously. According to Parker et al. (2016), internet enabled disruption occurs in two stages. In stage one, the efficient pipelines will replace inefficient pipelines due to the competitive advantage gained with digitalisation. The pipeline business model, which is enhanced by digitalisation and online services, benefits from low transaction costs and therefore these companies can outnumber the incumbent companies. We have already seen traditional businesses, like media and newspapers (AOL vs. paper media), retail and mail order shopping (Amazon vs. bookstores), as well as digital distribution (Netflix vs. DVDs). Then, in the second phase, the platforms eat the

pipelines by leveraging the network effects and the open electronic ecosystem by which any number of remote participants can collaborate and co-create value (Parker et al. 2016).

Platforms must first solve the ignition problem and attract both consumers and producers to achieve a critical mass required for efficient and valuable matchmaking (Evans and Schmalensee, 2016). A platform owner must solve a coordination problem by incentivising the users to join (Moazed and Johnson, 2016). Even though a multisided platform would reach a positive network effect and viral growth, it can also work in reverse and destroy the value of platform at explosive speed (Evans and Schmalensee, 2016). A challenger can enter the market at minimal cost due to software, internet, and cloud computing, as it has happened with online booking platforms.

In the context of the construction business, efficient pipeline business models and platforms are both opportunity and threat. The construction industry has made progress in digitalisation mainly in the domain of BIM, and it has become a de facto standard in the design phase for design information management. Unfortunately, there is no integration of design information to any Real-Time Control Systems (RTCS) nor to Enterprise Resource Planning (ERP) applications, which have already been used in other industries for decades. Low level integration of engineering, asset management, customer care, and operations on site level makes construction companies and the industry itself very vulnerable to game changers which have an efficient digital pipeline business model in use, as it is in the field service industry. However, the platform business model has already started to interest the research community of the construction industry as there is already published research for developing platform approach in industrialised house building (Maxwell and Aitchison, 2017).

6. CONCLUSIONS

Typical business model implementation in construction industry concentrates on securing the cash flow and high resource utilisation of both main and subcontractors. Supply chains are fragmented and competitive bidding is the modus operandi of the industry. Because of this the implementation of a business model can be described as a resource driven pipeline. The maturity of the implementation is low, due to the low degree of digitalisation and the lack of focus on customer value creation. The immature business models of the construction industry expose companies to disruption caused by efficient pipeline implementations and companies using a platform business model.

First implementations of the platform business model have already appeared in the construction industry, and most probably there is more to come. The example of Urakkamaailma.fi is a proof of successful adaptation of the concept of the platform business model in the construction industry. The construction industry should focus on business model development and understanding the possibilities of internally implementing the disruptive platform business model before the problem of the low rate of productivity development is solved from outside of the industry.

7. REFERENCES

- Armstrong, M., 2006, *Competition in two-sided markets*, The RAND Journal of Economics 37 (3): pp. 483–761
Bygballe, L. E. and Jahre, M., 2009, *Balancing value creating logics in construction*, Construction Management and Economics 27 (7): 695–704

- Chase, R., 2015, *Peers Inc: How People and Plat-forms Are Inventing the Collaborative Economy and Reinventing Capitalism*, Public Affairs, New York
- Choudary, S. P., 2015, *Platform Scale: How a new breed of startups is building large empires with minimum investment*, Singapur, Plaform thinking labs
- Dave, B., Koskela, L., Kagioglou, M. and Bertelsen, S., 2008, *A critical look at integrating people, process and information systems within the construction sector*, Proceedings for the 16th Annual Conference of the International Group for Lean Construction, pp. 795–807
- Elfving, J. A., Tommelein, I. D. and Ballard, G., 2005, *Consequences of competitive bidding in project-based production*, Journal of Purchasing & Supply Management 11: pp. 173–81
- Evans, D. S. and Schmalensee, R., 2016, *Matchmakers: The New Economics of Multisided Platforms*, Harward Business Review Press
- Hagiu, A. and Wright, J., 2015, *Multi-sided platforms*, International Journal of Industrial Organization 43 (11). pp. 162-174
- Horner, R. M. W. and Duff, A. R., 2001, *More for Less – a Contractor’s Guide to Improving Productivity in Construction*, CIRIA, London
- Laine, E. , Alhava, O. , Peltokorpi, A. & Seppänen, O. 2017, *Platform Ecosystems: Unlocking the Subcontractors’ Business Model Opportunities*, Proceedings for the 25th Annual Conference of the International Group for Lean Construction. Heraklion, Greece, 9-12 Jul 2017. pp. 177-184
- Lennon, D., 1999, *The future of “free” information in the Age of the Internet*, Aslib Pro-ceedings 51 (9): 285–9.
- Loosemore, M., 2014, *Improving construction productivity: a subcontractor’s perspective*, Engineering, Construction and Architectural Management 21 (3): pp. 245–260
- Maxwell, D. W. and Aitchison, M. 2017, *Design-Value in the Platform Approach*, Proceedings for the 25th Annual Conference of the International Group for Lean Construction. Heraklion, Greece, 9-12 Jul 2017. pp. 349 - 356
- Moazed, A. and Johnson, N. L., 2016, *Modern Monopolies: What It takes to Dominate the 21st Century Exonomy*, St. Martin’s Press
- Parker, G., Van Alstyne, M. W. and Choudary S. P., 2016, *Platform Revolution: How networked markets are transforming the economy – and how to make them work for you*, WW Norton & Company
- Osterwalder, A. and Pigneur, Y., 2010, *Business Model Generation A Handbook for Visionaries, Game Changers, and Challengers*, New Jersey, John Wiley & Sons
- Pekuri, A., 2015, *The role of business models in construction business management*, Doctoral thesis, C527, University of Oulu
- Pan, W. and C. Goodier, 2012, *Housebuilding business models and offsite construction take-up*, Journal of Architectural Engineering 18 (2): pp. 84–93
- Porter, M. E., 1998, *The Competitive Advantage: Creating and Sustaining Superior Performance*, 2nd ed. New York: Free Press
- Reillier, L.C. and Reillier, B., 2017, *Platform Trategy: How to Unlock the Power of Communities and Networks to Grow Your Business*, 1st ed. New York: Routledge
- Rochet, J. and J. Tirole, 2003, *Platform Competition in Two-Sided Markets*, Journal of the European Economic Association 1 (4): pp. 990–1029
- Sacks, R., 2016, *What constitutes good production flow in construction?*, Construction Management and Economics 34 (9). pp. 641–56
- Sacks, R. and M. Harel, 2006, *An economic game theory model of subcontractor resource allocation behaviour*, Construction Management and Economics 24 (8): pp. 869–81
- Scholz, T., 2017, *Uberworked and Underpaid*, 1st ed. Malden, MA: Polity Press
- Simon, P., 2013, *The Age of the Platform*, 2nd ed. Henderson, Nevada: Motion Publishing
- Sundararajan, A., 2016, *The Sharing Economy*, 1st ed. Cambridge, MA: MIT Press
- Thomas, L.D., Autio, E. and Gann, D. M., 2014, *Architectural leverage: putting platforms in context*, The Academy of Management Perspectives, 28(2), pp. 198-219, doi:10.5465/amp.2011.0105

TOWARDS A FRAMEWORK FOR MULTI-LOD 4D BIM SIMULATIONS

B. Butkovic and D. Heesom

Architecture and Built Environment, University of Wolverhampton, Wolverhampton, WV1 1LY, UK

Email: B.Butkovic@wlv.ac.uk

Abstract: In any construction project, the absence of sufficient information required for decision-making at the planning stage is one of the biggest problems. With emerging technology, the very act of designing change, from 2D drawings to 3D digital models, opens up the opportunity to assemble the models in the same way as a building is constructed. The use of Building Information Modelling (BIM) is now a critical aspect of the construction process and using this process, the development of a 3D model starts early in the development cycle. The Level of Graphical Detail (LOD) of the 3D model is affected by the time planned to build it and the size of the model and these important items need to be communicated. The level of detail of the information included in BIM also has an impact on the anticipated 4D usage executed by practitioners. This is a difficult topic because 4D simulations integrate both 3D components and construction activities schedules. Therefore, the BIM level of development incorporates geometry and non-graphical information. For that reason, a '4D LOD' requirement must manage both the graphical level of detail and the temporal level of detail. Whilst a wide range of research has been undertaken over the last 15 years in the field of 4D modelling, little has been presented in terms of developing an approach to understanding the level of detail required for 4D simulations. Based on the foregoing and an in depth review of the current status of 4D BIM, in particular issues surrounding the level of detail of 4D simulations and BIM in general, a framework is proposed to support the development of more dynamic 4D modelling. The anticipated framework attempts to focus on key issues identified in the literature. It seeks to address problems acknowledged within current construction planning practice together with the drawbacks and future capabilities of 4D methodologies, through the application of new technological solutions, directed towards a strong and innovative approach to construction plan creation.

Keywords: 4D Model, Collaborative Work, Level Of Detail, Project Planning

1. INTRODUCTION

In a construction project, the absence of sufficient information required for the decision-making at the planning stage is one of the biggest problems (Winch *et al.*, 1998). At the commencement period of a construction project, the result of the construction project is a little more than an idea and ambiguity is very high. With emerging technology, the very act of designing is changing from 2D drawings to 3D digital models and this opens up the opportunity to assemble the models in the same way as a building is constructed. These 3D building models could be spontaneously manipulated and collaboratively used in different phases of building construction (Song *et al.*, 2012).

The use of Building Information Modelling (BIM) is now a critical aspect of the construction process and using this process the development of a 3D model starts early in the development cycle. The Level of Graphical Detail (LOD) of the 3D model is affected by the time planned to build it and the size of the model and these important items need to be communicated. The level of development describes the accuracy of the 3D components and the quantity of information contained by each component. Level of Detail essentially defines model evolution (Bedrick, 2013). LOD in BIM is defined based on elements and the progression of the elements

all through the project from the lowest level approximation (conception design) to the highest level of the representation (as-built). The American Institution of Architects (AIA) has been developing principles to assist communication during the construction project. AIA E202 is a document providing guiding principles about the models indicating the relationship of the level of development with the proposed use of the model at every stage of the project (Kensek, 2014).

The level of detail included in BIM has to fit to the anticipated 4D usage executed by practitioners. This is a difficult topic because 4D simulations integrate both 3D components and construction activities' schedules. Trani *et al.*, (2015) noted that the Level of Graphical Detail of a 3D model changes from one stage of the construction process to another. Winch (2010) highlights that the utilization of 4D BIM provides the opportunity to link together the PBS and WBS at key stages, however these stages of design and construction evolve and subsequently so does the 3D model.

These construction accomplishments in projects are usually produced by different stakeholders in unsynchronized processes. Therefore, the BIM level of development incorporates geometry and non-graphical information. For that reason, a 4D LOD requirement must manage both the graphical level of details and the temporal level of information. Additionally, levels of detail must correspond to the industry needs' and the estimated usage of the model at different phases of the construction project (Boton *et al.*, 2015a). This is a specific area of research that has attracted a limited amount of research in comparison to other aspects of BIM implementation.

2. LITERATURE REVIEW

Whilst a wide range of research has been undertaken over the last 15 years in the field of 4D modelling, little has been presented in terms of developing an approach to understand the specific level of detail required for 4D simulations. Aouad *et al.* (2012) did postulate that more dynamic 4D simulations were required in order to achieve more reliable outcomes, when used in the planning process. Boton *et al.* (2015) also noted that levels of detail of the graphical models used during any 4D simulation must correspond to the industry needs' and the usage of the simulation at different phases of the construction project. Building on these issues, it has also been acknowledged that any specification of 4D LOD should manage graphical level of detail and the temporal level of information, in order to deliver realistic and more reliable 4D simulations (Tolmer *et al.*, 2015a). However, little has been undertaken to formalize these issues to provide higher quality, more useful 4D simulations. Much of the work undertaken around the issue of graphical level of detail is primarily focused on the graphical representation of objects within the Building Information Model, and indeed the UK NBS standards and USA AIA standards focused on this issue are key documents in the BIM Process.

Four-dimensional (4D) BIM has been recognized as an approach which improves construction planning techniques. The combination of 3D CAD with the schedule data has been quoted as the indicator of design and planning errors in many construction projects. Trebbe *et al.*, (2015) highlight how 4D BIM can be used to understand complex interconnections between different stages of construction work in any project. 4D model elements connected in 3D CAD models, allow project stakeholders to view all the accomplishments from design, procurement and construction schedules. All the planned construction of a building over time is shown on the screen and provides a 3D CAD model review for any day, week, or month of the project. In addition, it is believed that the use of these tools helps project participants reduce risk, attracting

quality team players, which is very important as the industry deals with the problem of the tight labour market (Zhou *et al.*, 2009a).

A 4D BIM has shown good potential as a starting point for planning progress and carrying out model based progress monitoring. However, the construction practices are still costly, with many errors and irregular completion. Researching the causes for these errors is able to improve future models. The level of detail in the BIM model is not appropriate enough for following the progress on a component-by-component basis (Han and Golparvar-Fard, 2015). Document coordination and installation coordination are crucial for providing better structure and quality and causing fewer issues during construction and during operation. (Hardin and McCool, 2015).

The solution for comprehending collaborative 4D planning is in the collaborative planning workflow. Starting with a shared 3D model that is manageable by all designers, this allows them to foster a collaborative scheduling session and continue work with multilevel communication. This interaction among planners allows them to perform their planning more effectively. Using a 3D model as a start, everyone involved in the planning process is able to evaluate the design, discuss planning approaches with each other, and propose solutions. The fact is that 3D and 4D process synchronization has an immense impact on the project's outcome (Zhou *et al.*, 2009b).

Building of a structure always goes gradually and these 3D models are not typically designed for 4D modelling, the model designers need to have 3D model layering systems that support the 4D activities (Aouad *et al.*, 2012a). 3D models have to be structured into work components to match the level of detail in the schedule. Geometric information has to be employed into different layers and 'CAD' components reorganized onto different sets. Absence of appropriate level of detail in 4D models was pointed out by Heesom and Mahdjoubi in 2003 when they were evaluating the construction process by using 4D models. They concluded that developing more dynamic 4D simulations would provide more realistic and more accurate results. However, for more than a decade this issue has not been addressed (Heesom, 2006a).

4D modelling techniques can simulate the construction process and identify potential conflicts in construction plans. The technique can be generated in a computer dynamic 3D construction process with a time progressing component, which allows 4D modelling to disclose hidden conflicts and enable an update and amendment of construction plans (Zhou *et al.*, 2014).

2.1 Technology for 4D and current applications

4D modelling is supported with many software applications (Table 1), whether they are part of a suite or stand-alone third-party applications. 3D elements are connected with time by either specifying detailed points within the modelling application, or by introducing a project schedule into the application. When forming a 4D model, the 3D model is brought in together with the project schedule and the link is then made in the application.

Table 1: 4D Tool / Applications

Company / Tool	Description	Linkage	Multiple LOD simulation
Bentley / Project Wise Navigator	Provides Project and analyse wise schedule simulation. Import 2D and 3D design files difference sources	Importing and connecting schedule information from Microsoft Project, Excel or Primavera. Reviewing interfaces (clashes) and viewing and analysing schedule simulations	No
Autodesk / Navisworks Suite JetStream TimeLiner	Supports various numbers of BIM formats and has overall very good visualization capabilities Permits the importation of schedules from a variety of sources	Supports manual and automatic linking to imported schedule data from variety of schedule applications Allows the user to join the items in the model with the tasks and simulate the schedule	Use of the images and animations created bring simulation up to date automatically if the model is changed.
Innovaya / Visual Simulation	Combines BIM objects with planning activities to complete a 4D construction. Generates simulation of construction process	Increases the project communication, synchronization and logistic scheduling. Links 3D design data in DWG with Microsoft Project or Primavera	No
Syncro Ltd / Syncro 4D	New 4D tool with improved scheduling and project management	Covers risk and resource analyses features and include built in tools to visualize risk, buffering and recourse usage in addition to 4D visualization	No
VicoSoftware / Virtual Construction	5D construction planning system which covers Constructor, Estimating, Control and 5D Presenter	Schedule data can be imported from Microsoft Project or Primavera and any changes in scheduling system are automatically reflected in the 4D visualization	No

If the 3D model and the schedule are established appropriately the connecting of the two elements together to form the 4D model should be a direct process. Lately some software applications have been technologically advanced to provide automated connecting, based on the exclusive indicators defined in both 3D modelling and planning software. During the construction development, the 3D design model and construction schedule have to be considered.

The current market offers several 4D CAD software applications. Bentley Navigator provides Project Wise Schedule Simulation for additional awareness of critical project schedule information, by importing and connecting to schedule information, accomplished in Microsoft Project, Excel or Primavera.

4D CAD Modelling software in Innovaya Visual Simulation combines BIM objects with planning activities to complete 4D construction preparation and constructability review. This tool successfully increases the project communication, synchronization and construction logistics scheduling. Visual 4D Simulation incorporates a very strong 3D appliance and in particular an approachable intersection. Therefore it benefits, builds and improves task systems which provide project time savings (Aouad *et al.*, 2012b).

Even though 4D modelling has been recognized as technology with clear advantages during the design and construction process, a number of weaknesses have been noticed when applying technology during the construction project. Limitations of 4D modelling are (Aouad *et al.*, 2012c):

- The need for two or more software applications in order to integrate design and planning information.
- The absence of construction plan information as the construction activities could not all be visually presented.
- No clear evaluation and duration of activities in the project.
- Persistent need for the Gantt chart to present activities' relationships
- The project team still have to modify or optimize the schedule manually for a 4D model in order to completely recognize its benefits.
- Lack of more dynamic 4D simulation in order to achieve more reliable outcomes

2.2 LOD in 4D modelling

The level of detail and in particular the granularity of individual geometric objects included in BIM has to fit to the anticipated 4D usage executed by practitioners. This is a difficult topic because 4D simulations integrate both 3D components and construction activities' schedules. For that reason, a 4D LOD requirement must manage both the graphical level of details and the temporal level of information. Additionally, levels of detail must correspond to the industry needs' compatibility with the estimated usage of the model at different phases of the construction project (Boton *et al.*, 2015b). There are two critical factors that exist when thinking towards the end usage of a 4D model. Firstly, the planning horizon used and subsequently the time period between state changes in the simulation i.e. 1 day, 1 week etc. Secondly having geometry at a level of granularity that can be linked to tasks produced at the relevant planning horizon to present an accurate reflection of the construction sequence. Thus far, limited research has been undertaken on the critical issue of 4D LOD issues, although the importance of the level of detail and its impact on BIM projects has been indicated repeatedly in available literature. As BIM level of development includes geometry and non-graphical information, 4D LOD has to manage both graphical levels of detail and temporal level of information. Moreover, the levels of detail need to agree to industry requirements compatible with the expected usage of the model at different phases of the construction project (Heesom, 2006b). To date there is no standards or benchmarks produced in this field and so considerable research is required in order to fill this void in knowledge.

Han and Golparvar-Fard (2015) suggest that the lack of detail in the 3D BIM used for the pre-construction purpose in projects is not sufficient enough for tracking the progress on individual element bases. LOD300-400 is similar to less detailed models than traditional construction documents.

Boton *et al.* (2015) presented a case study of the development of 4D models at various stages of the design and construction process. However, the development of the Level of Detail within this project was predominantly focused on the graphical detail of the design model. Models were generated in accordance with the AIA LOD 100-600 series using a range of software tools and then 4D simulations were created. The work did highlight the changes required for the resolution of the plan at each stage and this was appropriate for the detail of the graphical model, also noting that LOD required for the construction phase is higher than the LOD needed

in the pre-construction phase (Kriphal and Grilo, 2012). However, it did not resolve the critical issue of decomposition of construction product elements for the generation of more dynamic 4D models and whether this is also required to change to meet the needs of project planning through the various phases of the lifecycle of the design and construction. The study did conclude that a single graphical LOD is not adequate during the construction phase and that different levels of development were needed for visualization and coordination, depending on the 4D model purpose and the specific construction problems that occurred during construction and modelling processes. This view is supported by McGeorge and Zou (2013) who note the understanding of complex models could be aided by the technique of model decomposition that subdivides models into smaller significant sub-models in order of their conception.

It is apparent that in 4D models, LOD specification should manage graphical levels of detail and the temporal level of information in order to deliver realistic and more reliable 4D simulations (Tolmer *et al.*, 2015b).

3. CONCEPTUAL FRAMEWORK FOR MULTI-LOD 4D BIM

Based on the foregoing review of the current status of 4D BIM and in particular issues surrounding the level of detail of 4D simulations, a framework is proposed to support the development of more dynamic 4D simulations.

The anticipated framework attempts to focus on key issues identified in the literature. This conceptual framework is set to address problems acknowledged within current construction planning practice and the drawbacks and future capabilities of 4D methodologies through the application of new technological solutions, directed towards a strong and innovative approach to construction plan creation.

It is anticipated that the implementation of this framework through a novel software platform would improve current planning practices by allowing appropriate, visual planning through in-built communication within a building information model. Furthermore, more dynamic 4D modelling would promote and enable more collaborative and coordinated construction planning.

The focus of the framework is the Dynamic 4D model (D4DM) such that the planner can produce and utilize more realistic and representative simulations of the construction process at various temporal and graphical resolutions. The construction planner should have the ability to decompose a single component into sub elements according to areas and related activity into sub activities. This technique proposed by Akbas and Fischer (2002) is postulated in the framework. These areas can be created at different levels of detail to contribute to a more comprehensive view of the schedule (Fischer *et al.*, 2000). Many parts, including the shape of the construction zone, import the efficiency level used during the progress of the dynamic phase of the geometry axes (Akbas, *et al.*, 2001).

A 4D simulation contains a link between both the 3D model's objects (graphical LOD) on one side and the construction activities' time schedule (temporal LOD) on the other. They are both usually part of asynchronous process. It is important that a 4D model's LOD specification must manage graphical LOD and temporal LOD information. The importance of LOD is to specify all information that the model needs to have included at every stage of the project duration. The work in progress in the centre allows the planer to monitor different

stages of the model at different level of detail where various levels of development were defined from LOD 100 to LOD 500 produced at various construction times during different construction tasks. The proposed framework emphasizes the necessity for planning, controlling and coordinating construction phases using visualized analysis of conflicts and clashes in models even before construction works.

Levels of accuracy that are possible in the budget are usually seen through the appraisals of product breakdown structures (PBS) used for initial-stage budgetary planning and the work breakdown structure (WBS) used throughout the scheduling and implementation phases of the project (Winch, 2010). As construction project planning concentrates on time and cost management planning is a continuous task. The WBS method delivers an extended way to calculate, outline, measure and control the elements of a given work scope. This is the reason why the PBS and WBS must be included in the framework as the PBS is part of preliminary project phase financial planning and the WBS is part of the development of project execution and scheduling during the course of the project. The level of granularity of each of these has to be coordinated in order to ensure that a dynamic 4D model is fit for purpose.

The capability to decompose building products in a 3D model is fundamental in the execution of accurate multiple level of detail in a 4D simulation. The development of the geometry reflecting the development of a building product is essential to be presented and to be created in alignment with the temporal resolution of a construction task. The technique of model decomposition that subdivides models into smaller significant sub-models is a great asset for understanding the complex models.

Any novel software platform requires simple methods of human computer interaction, and this requires the need for quality user interface characteristics. Computer graphics and applications involve visual designs of images, animation and 3D virtual reality and products. In building design, the engineering characteristics are just as important as the aspects of appearance. The function depends on visual qualities and quantitative analysis.

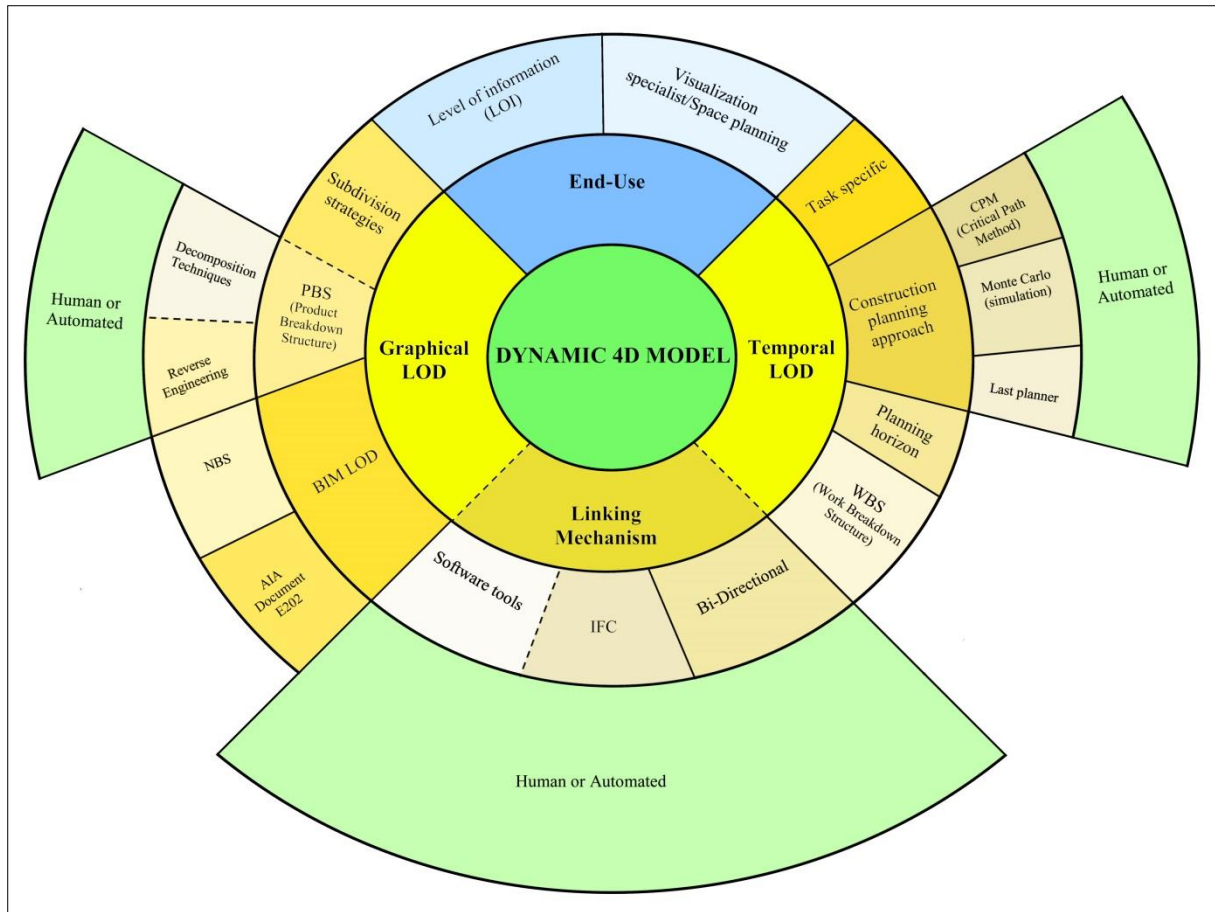

Figure 1: Conceptual framework of Dynamic 4D model (D4DM)

4. CONCLUSIONS AND FUTURE WORK

4D is evolving as a construction planning technology to address some of the challenges currently faced by the AEC industry. 4D planning has the ability to increase the visualization of the building design and construction. This 4D technology can improve the visualization but still needs time to reach maturity. Where 4D technology has been included the outcomes indicate savings and a growth in productivity. The use of 4D shows that it can save money on construction projects by recognizing difficulties seen in earlier construction projects and by avoiding re-work during the project.

This study presents a framework for creating a more dynamic 4D model by using information from Building Information Modelling. The critical parts of the conceptual framework are the graphical level of detail and various levels of temporal detail. Both graphical and temporal levels of details are influenced by numerous factors crucial for the construction project. Further work in this research study will include the development of an industry based questionnaire to further develop the conceptual framework and specific assess industry requirements for each of the key attributes.

Subsequent to this an appraisal of most appropriate software tools will be undertaken to progress the development of prototype software tool that will allow the generation of interactive dynamic 4D simulations at multiple levels of detail. Preliminary technology and software evaluation have identified Autodesk Dynamo as having the potential to develop a

prototype due to having the ability to obtain geometric control within in a BIM environment and externally to the underlying project planning database that is not possible when using a conventional modelling interface. Furthermore, Autodesk Navisworks is being investigated as a potential Commercial Off The Shelf (COTS) tool to support prototype development. Navisworks supports manual and automatic linking of geometry to schedule data from a variety of schedule applications.

5. REFERENCES

- Akbas, R., and Fischer, M. (2002) *Construction Zone Generation Mechanisms and Applications*, ISARC 2002, 19th International Symposium on Automation and Robotics in Construction, Sep. 23-25, 2002, Washington DC, USA, NIST SP 989, William C. Stone, editor, pp. 293-298.
- Akbas, R., Fischer, M., Kunz, J. and Schwegler, B. (2001) CIB W78 Conference, IT in Construction in Africa, Mpumalanga, South Africa, 29 May- 1 June, 2001
- Aouad, G., Lee, A., Wu, S. and Onyenobi, T. (2012) *Computer Aided Design Guide for Architecture, Engineering and Construction*. New York: Spon Press
- Bedrick, J. (2013) *A Level of Development Specification for BIM Processes* [blog entry]. [Accessed 16 November 2015]. Available at: <<http://www.aecbytes.com/>>
- Boton, C., Kubicki, S. and Halin, G. (2015) The challenge of level of development in 4D/BIM simulation across AEC project lifecycle. A case study, *Procedia Engineering*, **123**, pp.59-67
- Fischer, M., Guibas, L. J., Kunz, J. and Akbas, R. (2000) *Geometric Representations for Construction Planning and Scheduling*. CIFE Seed Proposal, Unpublished. CIFE, Stanford University.
- Han, K.K. and Golparvar-Fard, M. (2015) Appearance-based material classification for monitoring of operation-level construction progress using 4D BIM and site photologs, *Automation in Construction*, **53**, pp.44-57
- Hardin, B. and McCool, D. (2015) *BIM and Construction Management* [online]. Indianapolis: Wiley. [Accessed 10 October 2015]. Available at: <<https://www.dawsonera.com/>>
- Heesom, D. (2006) *Interactive Generation of 'Multi-Level of Detail' 4D CAD Simulation: 6th International Conference on Construction*. Application of Virtually Reality, Orlando, Florida, August 2006
- Kensek, K.M. (2014) *Building Information Modeling*. New York: Routledge
- Kriphal, M. and Grilo, A. (2012) Compatibility between design and construction building information models, *ECPPM Proceedings*, pp.447-452
- McGeorge, D. and Zou, P. (2013) *Construction Management: New Directions*. 3rd ed. West Sussex: Wiley
- Song, S., Yang, J. and Kim, N. (2012) Development of a BIM-based structural framework optimization and simulation system for building construction, *Automation in Construction*, **63**, pp.895-912
- Tolmer, C.E., Castaing, C., Morand, D. and Diab, Y. (2015) Information management for linear infrastructure projects: conceptual model integrating Level of Detail and Level of Development: *Proc. of the 32nd CIB W78 Conference*. University of Technology, Eindhoven 27-29 October. Rotterdam: International Council for Research and Innovation in Building and Construction, pp.735-743
- Trani, M.L., Cassano, M., Todaro, D. and Bossi, B. (2015) BIM level of detail for construction site design. A case study, *Procedia Engineering*, **123**, pp.581-589
- Trebbe, M., Hartmann, T. and Andre, A. (2015) 4D CAD models to support the coordination of construction activities between contractors, *Advanced Engineering Informatics*, **49**, pp.83-91
- Winch, G.M. (2010) *Managing Construction Projects*. 2nd ed. West Sussex: Wiley
- Winch, G.M., Usmani, A. and Edkins, A. (1998) Towards Total Project Quality: A Gap Analysis Approach, *Construction Management and Economics*, **16**, pp.193-207
- Zhou, W., Heesom, D., Georgakis, P., Nwagboso, C. and Feng, A. (2009) An interactive approach to collaborative 4D construction planning, *ITcon Vol. 14, Special Issue Technology Strategies for Collaborative Working*, pp. 30-47, http://www.itcon.org/cgi-bin/works/Show?2009_05
- Zhou, W., Heesom, D. and Tah, J.H.M. (2014) User-centred design for collaborative 4D modelling, *Construction Innovation*, **14**(4), pp.493-517

SHAPING TOMORROWS BUILT ENVIRONMENT: DRIVING INNOVATION THROUGH HIGHER EDUCATION ENGAGEMENT

S. Dawson and J.S. Goulding

Department of Architecture and Built Environment, Northumbria University, Newcastle, NE1 8ST, UK

Email: susan.dawson@northumbria.ac.uk

Abstract: The Architecture, Engineering and Construction (AEC) sectors are major contributors to the world's economy. For example, in the UK alone this contribution exceeds £110 billion per annum. However, despite this significance, AEC has been continually criticised for high levels of fragmentation, poor productivity and efficiency, and general lack of innovation. This is stark contrast to (seemingly) better performing industrial sectors in aerospace, pharmaceutical and oil and gas. Consequently, this has impacted on skills, and more importantly, the attraction and retention of talent (intellectual capital). Cognisant of these challenges, this paper evaluates these areas of contention through the research lens of the AEC sector; where three specific exemplars of these higher performing industries are evaluated through existing strategic partnerships/alliances. The formative rationale of this approach establishes the underpinning rubrics needed for a translational engagement model to meet AEC/Higher Education Institutions (HEI) needs. From a research methodological perspective, this paper evaluates extant literature and presents three successful non-cognate strategic partnerships with HEI's. Research findings are presented through a conceptual model which outlines principal patterns of engagement covering: i) the knowledge creation cycle, ii) the interface of academia and industry, iii) shared synergies iv) core challenges, and v) tangible engagement opportunities. This forms part of wider research on strategically embedding innovation within AEC processes to leverage/nurture sector improvements.

Keywords: Engagement, Higher Education, Innovation, Strategy, Working Relationship

1. INTRODUCTION

The global Architecture, Engineering and Construction (AEC) markets are forecast to grow at a rate of 5.5% from 2016 to 2021. Emerging trends, which have a direct impact on the dynamics of the construction industry, include, but are not limited to: the increasing demand of new, innovative green construction to reduce carbon footprint and enhance the life of building structures; the need for new technologies in building information systems to improve the efficient delivery and management of projects; and the need to develop innovation and improvement strategies to secure sector resilience. Five geographical construction hotspots highlighted by Cision (2016) driving demand, based on anticipated worth in 2020, include:

- India: predicted to be worth US\$563.4bn by 2020. The construction industry in India employs more than 35 million people and is currently valued at more than \$126 billion. It is expected to be the world's third largest construction market by 2030
- UK: predicted to be worth US\$208bn by 2020. Growth in the UK construction industry is expected to stay at around 3% with employment projections reaching 2.74 million in 2019.
- Mexico: predicted to be worth US\$144.9bn by 2020.

- Qatar: predicted to be worth US\$59bn by 2020. With significant government investment, a stable business environment and growing consumer demand, Qatar is the fastest growing construction and infrastructure market in the Middle East. The 2022 FIFA World Cup has created around \$135bn worth of contracts.
- Egypt: predicted to be worth US\$12bn by 2020. The construction industry in Egypt grew at 8% in 2015 (see - Recruitment-international.co.uk, 2017)

These five geographical hotspots evidenced considerable growth since the global recession in 2008 – the corollary of which created an employment boom “Countries like India, Mexico and Egypt are calling out for industry professionals with project management skills, as well as quantity surveyors, architects and civil engineers” (Recruitment-international.co.uk, 2017). Given this, AEC makes a significant positive contribution to industry and society. However, despite these contributions and the forecast of growth, AEC is often criticised for its inefficiencies and has been continually identified as underperforming (Fairclough, 2002; Egan, 1998; Latham, 1994; JLL, 2017; Australian Government, 2017). Given this, a drive is needed to enable the sector to effectively engage with opportunities to deliver the required level of growth.

In the UK, the reports of Banwell, (1964), Latham (1994) and Egan (1998) all advocated the need to change, though reform vehicles which embraced partnering and collaborative working, through to learning from other industries, particularly manufacturing. In May 2008, ten years after the publication of “Rethinking Construction”, Sir John Egan stated that “...we have to say we’ve got pretty patchy results. And certainly nowhere near the improvement we could have achieved, or that I expected to achieve...” In summary, “I guess if I were giving marks out of 10 after 10 years I’d probably only give the industry about four out of 10, and that’s basically for trying, for having its demonstration projects, still being in the game, and still having enough there to actually, perhaps with another big heave, get it done the next time around” Egan (2008). Whilst consensus on the success of these reforms is still under debate, certain areas have evidenced performance improvements. Of note, the sector driver of engaging with Building Information Modelling (BIM) and digitisation of processes has evidenced significant pockets of success. However, increased client expectations, and the need to secure cost and process efficiencies using smart technologies, advanced offsite manufacturing processes, and new skillsets continue to drive the ‘improvement’ agenda. Globalisation and the rate/pace of change is also a significant lever. The corollary of this is the projected impact of these changes on technical and professional skill/roles. This resonates to thinking on the knowledge economy and the projected fourth industrial revolution (Industry 4.0). Given this, the skills profile of professional occupations will undoubtedly need to evolve over the medium to longer term, to embrace multiple different skills and emerging areas of knowledge. This will also necessitate a change from traditional ‘silo-based’ approaches to skills and professional disciplines which actively encourage and engage new ways of thinking, working and behaviour. This by default is likely to embrace non-cognate disciplines, new partnerships and supply chain influences; which will require progressively closer integration between core disciplines and skills sets (to gain mutual understanding and appreciation of other roles and their contribution to AEC). On this issue, intra - and inter-industry learning will become increasingly more important to evaluate discovery patterns and advanced innovation opportunities. The technology, ICT and pharmaceutical sectors are fervent showcase exemplars that have truly exploited their innovation premium (Forbes, 2016). However, from an AEC perspective, this will also need increased investment in research and innovation (UK Commission for Employment and Skills, 2013). Whilst industry complexity remains a

challenge, new innovation opportunities are continually being uncovered (Akintoye et al, 2012).

Whilst the above presented recurrent themes of underperformance, it transpires that AEC does not really seem to have progressed (compared to other sectors). Moreover, AEC has not actively engaged with higher educational institutions (HEI's). Given this, this paper draws a series of comparisons of how other industries have chosen to engage with HEI's to drive increases in performance. These issues are summarised and embedded into an Industry-Academia Engagement Interface Model to not only provoke discussion (with in AEC), but also engage in wider debate. The next section starts this discussion by considering the context of AEC and the concomitant push-pull factors acting as barriers or enablers to this engagement.

1.1 AEC push-pull forces

The identification of push and pull factors (sometimes termed 'forces') is one specific way of defining key identifiers for organisational transition. Put simply, the "want" or "need" to move from one state/position [push factors] to another state/position [pull factors]. Push and pull factors therefore (by default) vary significantly from one organisation to another, depending on the scenario, level of maturity, size and structure, organisational dynamics etc. However, many high-level generalisations and similarities can be drawn. In particular, a number of what may be considered to be 'critical' push and 'critical' pull factors that have (or may have) the potential to impact or shape future strategies needed to leverage innovation and success – see Table.1.

Table.1: AEC: Push-Pull Contention Forces

AEC	
Push	Pull
Lack of Innovation	Innovation driven
High levels of fragmentation	Green and sustainable building
Not progressive or forward thinking	Increased agility, progressive, visionary
Poor efficiency	Global growth, +30% more efficient
Poor productivity	Emerging IT technologies
Output rather than process focus	Intelligently refined processes
Weak project monitoring (loss of learning)	Rich data collection
Low levels of collaboration	Collaborative/sharing culture
Talent shortage and low retention	Attracting and retaining quality talent
Poor image brand	Positive social impact

Table 1 presents the predominant push-pull forces of contention resonating in recurrent AEC literature. This was developed using word-frequency citations, from Web of Science, AEC professional bodies' databases, and Google Scholar. Whilst it is advocated that this table is not exhaustive, the intention here is to present broad generalisations – and how this develops the narrative to support the need for an engagement model. Readers may wish to explore deeper discussion in this area through such proponents as Slaughter (1998); Winch (2003); Sexton and Barrett (2003) etc. One of the key finding highlights the relatively low levels of innovation in AEC, and coincidentally (perhaps?), limited levels of collaboration with inter- and intra-industry partners - including Higher Education Institutions (HEI's) and Research and Development (R&D) bodies. This presents fervent grounds for much deeper discussion.

1.2 HEI's role as an innovator

Globally, HEI's are key contributors to the knowledge economy. They incorporate significant intellectual wealth – both tacit and explicit. These valuable assets and knowledge repositories underpin and support economic policies and help deliver commercial wealth. This wealth includes a raft of issues, including sector competitiveness, innovation, product differentiation and discovery zephyrs (for future exploitation). Mindful of this, HEI's are therefore able to harvest knowledge in a slightly different way to conventional in-house R&D investment. Given this, successful industry-HEI partnerships embrace almost every sector, from manufacturing through to medicine and aeronautics – which includes AEC. Moreover, several studies and case exemplars highlight how these 'partnerships' have revolutionised new ways of working and thinking. Recurrent themes include the importance of such partnerships, including “When companies and universities work in tandem to push the frontiers of knowledge, they become a powerful engine for innovation and economic growth. Silicon Valley is a dramatic example. For over five decades, a dense web of rich and long-running collaborations in the region have given rise to new technologies at a breakneck pace, and transformed industries while modernising the role of the university” (Science Business Innovation Board, 2012).

These partnerships manifest in various modes and models, from informal arrangements, through to commercial contracts and strategic alliances. Whilst the derivation and mechanics of these are beyond the scope of this paper, it is important to acknowledge that these exist, and that the type and structure of these fundamentally affects the *modus operandi* of such arrangements. Notwithstanding the conflation of these issues, the real challenge is to determine successful patterns of engagement – and perhaps more fundamentally, what makes [or constitutes] 'success'? This invokes discussion on why HEI's in some areas seem to be reluctant or seemingly unwilling to engage with industry (and *vice versa*). Taking AEC as an example; perhaps this is due to its inability to embrace innovation and new ways of working? There are however several AEC studies that have started to “break the glass ceiling” highlighting significant breakthroughs using HEI-industry engagement. One key dimension in this discussion is the need to provide the appropriate skill-sets needed to manage successful transition (Table 1). Skills are by default time and context-bound. AEC is continually changing, and the need for high-level skills remains a priority. Conversely, there is an exigent need to ensure HEI's meaningfully engage with industry in order to: demonstrate relevance [content], ensure the 'right' prerequisite skills are developed [capability], and to impart relevant R&D knowledge back into the sector for future uptake. These are significant challenges. Thus, there is an intrinsic need to harvest these dimensions into some form of engagement model – the provision of which would help provide forward trajectories and synergies for impactful research and mutual benefits.

Examples of conjoined synergies include: IBM's new \$90 million nanotechnology centre in Zurich. The Binnig and Rohrer Nanotechnology Centre is the cornerstone of a new 10-year strategic partnership in nanoscience between IBM and the Swiss Federal Institute of Technology (ETH Zurich). This collaborative arrangement advances energy and information technologies – with tangible outcomes (Science Business Innovation Board, 2012). However, the corollary with AEC-HEI partnerships seems to relate to R&D investment. For example, the 2014 EU Industrial R&D Investment Scoreboard ranked construction among the least R&D intensive sectors. In contrast, the pharmaceutical and automotive sectors often spend in excess of 30% of turnover on R&D, whilst construction on average invests as little as 6% (Office for

National Statistics, 2016). This underinvestment in AEC R&D may act as a major barrier (World Economic Forum, 2016). Similar AEC challenges include: protectionism, high levels of competition, and high levels of industry fragmentation. Whilst these issues are significant and palpable, they are not unsurmountable. Mutual and conjoined benefits have been successfully harvested in AEC. These partnerships/arrangements do however seem to be parochial, isolated, and under-reported.

In summary, cognisant of the above issues, it is advocated that there is now a cogent need to capture inter and intra-industry drivers and enablers to marshal, engage, and align intellectual capital to drive AEC innovation. The following section highlights some of these factors.

2. NON-COGNATE CASE STUDY EXEMPLARS

Extant literature provides a number of fervent issues for debate on the benefits of HEI – industry engagement. From this, a number of “lessons learned” have been highlighted, on issues ranging from the development of research and training partnerships, through to the delivery of innovative alliances (Powers *et al*, 1988). However, the following three case studies were developed as part of the Science Business and Innovation Board AISBL 2012 report “Making Industry-University Partnership Work”. These three cases studies were selected as exemplars of industry-HEI engagement. Empirical lessons learned from this research provides a series of patterns for future uptake. A synopsis of three case studies are presented. The main findings from these are then used to shape, inform and populate an Industry-Academia Engagement Interface Model presented in the Discussion section.

Case Study 1: MICROSOFT-CISCO-INTEL-UNIVERSITY OF MELBOURNE

A partnership to forge skills for the 21st century. In 2008 Microsoft, Cisco and Intel agreed to launch an industry-university partnership with the University of Melbourne to transform education for the 21st century. Their goal was to have a game-changing impact by first identifying the higher-order skills that students needed for success. The partnership focussed on the critical skill sets needed for a global knowledge economy. This multi-stakeholder industry-university partnership overcame general scepticism that collaborative problem-solving skills and digital literacy could be accurately measured. It managed a highly complex global academic research effort across 60 research institutions and successfully developed a new set of tools (computer-based collaboration and problem-solving) to assess skills – forming new curricula. Key outcomes included: five white papers defining the skills of the 21st century; several peer-reviewed journals; and new assessment tools for core skill sets. Six countries (Australia, Costa Rica, Finland, the Netherlands, Singapore, and the United States) piloted the assessment skills in cognitive labs on 5000 students.

Case Study 2: SIEMENS-TU BERLIN, MIT, TUM

This arrangement formed part of a wider series of long-term strategic partnerships with universities to foster an intensive transfer of knowledge. However, the focus was to move away from “a large number of not very structured relationships,” to key university partners based on topics of strategic value to the company. Eight such partnerships exist – four in Europe, two in China and two in the US. The underpinning rationale of Siemens was to seek universities with an “open culture”. With the Technical University of Berlin, the company works on innovation related to energy-efficient cities. At MIT, the partnership focused on health care and medical technologies, and at the Technical University of Munich, emphasis was placed on electric mobility and optimised ICT embedded systems. Core findings emanating from these

partnerships included the creation knowledge feeding the development of future products, particularly innovations in existing products and evolution breakthroughs for further innovation. The Siemens-MIT collaboration in brain research included Siemens providing MIT with a prototype of the latest magnetic resonance imaging technology. Pivotal learning points include develop a “paradigm shift”. It was also acknowledged that universities were more “open”.

Case Study 3: NOKIA-AALTO UNIVERSITY, UC BERKELEY

This university collaboration was considered vital to Nokia’s research efforts; not just to improve overall competitiveness, but more to use this as a transformational vehicle for divesting itself away from a product-centric company to one more focused on service provision. The company’s current focus is on strategic collaborations in energy efficiency, communications technology and location-based services. They are exploring technologies that may impact the market in three to five years. Nokia has a long-running collaboration with Aalto University in wireless technologies and multimedia technology research. The company has two teams working in university laboratories, and Aalto researchers also work at Nokia’s Research Centre. The results from this partnership have generated a high number of patents, publications and skilled people entering Nokia as new employees. Moreover, Finland’s national technology funding programme helps enable this partnership through bespoke industry-academia research funds. Of note was the importance of engaging in ‘disruptive research’ which would be considered too risky without this partnership. The UC Berkeley’s arrangement focused on enabling improved traffic circulation and GPS systems. This included access to traffic patterns and prediction scenarios.

2.1 Reflection

Given the diverse patterns, strategies and modus operandi of both HEI/industry structures, there is strong evidence to suggest that there is a need to find common ground, or areas of conjoined synergies that deliver tangible benefits to all parties. However, equally, it is acknowledged that the development of effective partnerships often take time to demonstrate real impact, with strategic partnerships often only maturing between 5-10 years. A number of factors underpin this, including the creation of metrics used to measure impact, either through academic outputs, contribution to profits, or unexpected “softer” measures and unanticipated benefits (Science Business Innovation Board, 2012). However, intrinsic needs include the provision of appropriate leadership. Leadership defines what the future should look like; it also helps align people with the vision and capability to make this transition happen despite anticipated obstacles (Kotter, 2012). From an HEI/Industry partnership perspective, this requires senior engagement from both sides in order to: establish common goals, vision, ambition and priorities; where clear mutual benefits on both sides are established. "Leadership is a process that involves: setting a purpose and direction which inspires people to combine and work towards willingly; paying attention to the means, pace and quality of progress towards the aim; and upholding group unity and individual effectiveness throughout" (Scouller, 2011) However, agreeing and setting a strategy across culturally different sectors is not without challenge (Mullins, 2010). On this theme, it is interesting to reflect on the House of Quality; in particular, the European Foundation for Quality Management (EFQM) Excellence Model type approach (see Mullins and Christy, 2010). Partnerships can often leverage wider benefits than they would have been able to achieve on their own – the analogy “The whole is greater than the sum of its parts” (Aristotle, n.d) springs to mind. Similarly, leadership needs to be transformative (Kahan, 2013). Which, from an AEC-Industry arrangement requires

establishing key priorities from both parties to create a win-win situation. Again, reflections on organisational culture (see Geletkanycz, 1997; Johnson, 1992; Young, 1989) will need to be carefully managed. Part of this also includes the people-element – where people (and their perceptions) affect positioning and behaviour. An example of this is “siloes thinking”. This is where “bridge builders” are needed – people with unique transdisciplinary skills to break down barriers on both sides. There are various mechanisms that can effectuate this, including communities of practice, advisory boards and cross-mentoring strategies. Put simply, a multidisciplinary approach is needed with open boundaries. Siloes-thinking and entrenched positioning is somewhat counterproductive to the shared collective vision needed. In some respects, AEC has a distinct advantage here as construction is already a collaborative activity (Constructing Excellence, 2017).

The challenge therefore is to harness (and celebrate) cultural divisions. Synergies can be mapped and agreed to mutual satisfaction. Moreover, there are several key exemplars which typify this. Given this, AEC-specific drivers and unique identifiers are therefore needed to create patterns of success for future mutual exploitation. Some of these issues are presented in the following section.

3. DISCUSSION

AEC is continuing to develop, evolve and grow. In some respects, certain theorists have posited that ‘conventional’ sector-specific boundaries are becoming increasingly blurred. Mergers and acquisitions are good examples – where semi-cognate bodies have aligned e.g. manufacturing with construction (see link to Design for Manufacture and Assembly, Offsite Manufacturing etc.), or non-cognate (see technology providers and service sector arrangements). However, evaluation of literature suggests there are significant benefits to be garnered through AEC-Industry partnerships. Underinvestment in R&D and low levels of innovation are two ingredients that have stifled progression – (see discussion on sector reports). Given this, there is a real opportunity to develop, foster and grow optimised engagement strategies with HEI’s and the AEC communities - similar to those adopted by other [seemingly] more innovative and progressive sectors such as manufacturing, aeronautics, medicine etc. Analysis of these partnerships has identified a number of critical ingredients needed for successful partnerships, including ‘lessons’ learned. These issues include (but are not limited to): culture; leadership; long term strategy; shared vision; commercial drivers; evidence indicators, and the need to identify enablers, blockers and opportunities. Evidence from the three case studies were cross-referenced with findings from Table 1 to generate a conceptual model detailing the interface between industry and academia, and the internal/external forces which govern engagement. These are presented in an Industry-Academia Engagement Interface Model (Figure 1).

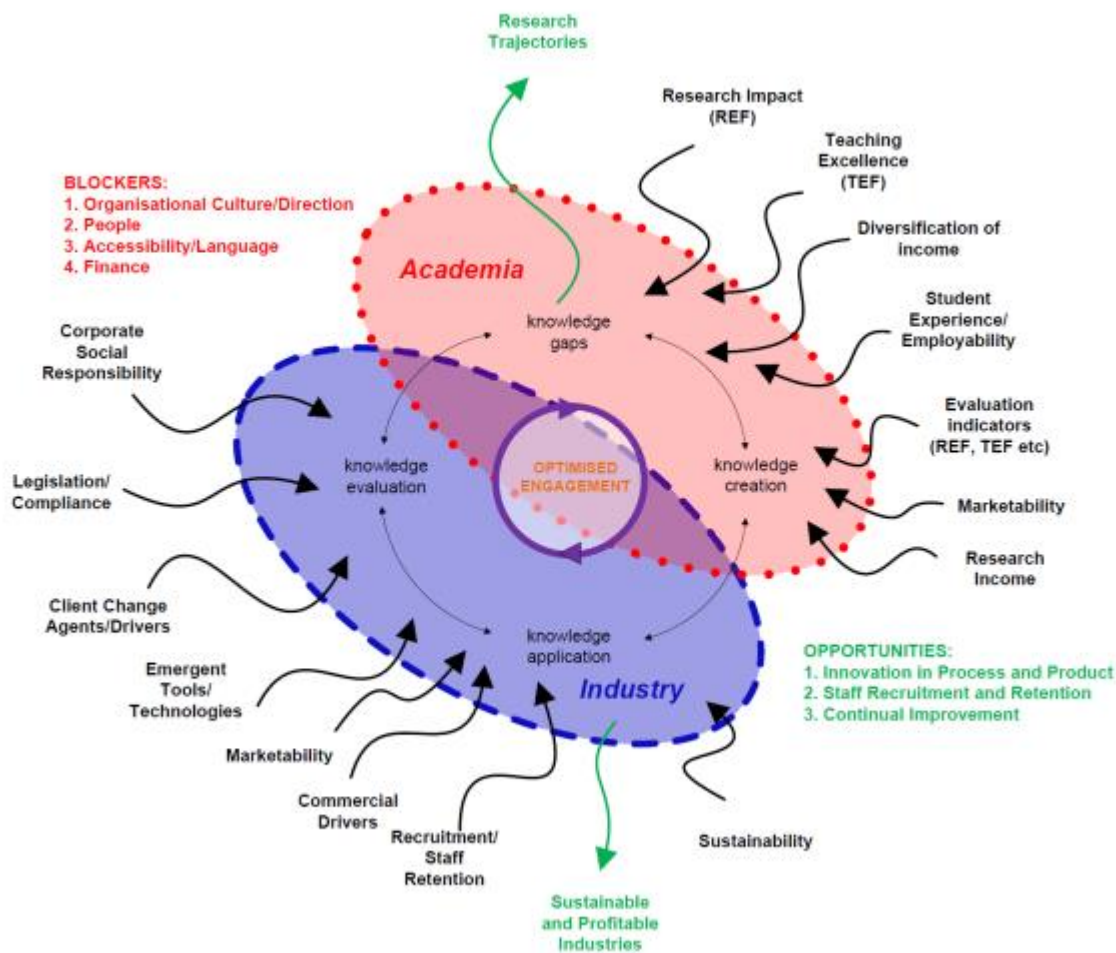

Figure 1 Industry-Academia Engagement Interface Model

From Figure 1, the two pivotal orbits of industry and academia coalesce around a central core “optimised engagement”. The overlap of these two entities are dependent upon several factors, not least the maturity of each party, the concomitant time period of this partnership (as longer partnerships are generally more beneficial – hence a greater overlap), and the number of synergies embedded in this relationship. The wider concentric knowledge orbit (knowledge gaps, knowledge creation, knowledge application and knowledge evaluation) is the metaphorical ‘glue’ which binds this partnership (through conjoined outcomes). However, one key aspect of this model is the need to ensure this is driven by ‘suitable’ people *viz* seniority, multidisciplinary expertise, shared visionary capacity (thinking) etc. The absence of these will not only stifle success, but also hinder engagement and any optimised outcomes. This Industry-Academia Engagement Interface Model goes one step further by identifying specific industry issues, including corporate drivers associated with core business need. In terms of academia this includes activities relating to: research, teaching and student experience. Whilst these are somewhat generic – the value laded components include the specific metrics or measures placed on determining their success. Whilst this is a discussion for future works, at this juncture the most important message to impart is that of securing the interface between vested parties. Optimised engagement is therefore a product of nurturing and continual refinement. The challenge therefore is to establish the rubrics and modus operandi of such engagement model to deliver the optimisation wheel. A good example of this is to reflect on the process of change, and issues resonating with such theorists as Lewin (1947) and unfreezing, change, then

refreezing. Thus, it is advocated that the unique strengths of academia and industry (AEC) can provide rich and fertile grounds for further exploitation.

4. CONCLUSION

This paper presented the recurrent issues facing AEC, in particular, its performance and relationship to other sectors. Whilst advocates acknowledge that some attempt has been made to change industry thinking through conduits endorsed/supported by various reports and government mandates; proponents believe this transition has not been as progressive as it could have been – positing that other industries seem to do significantly better. Now whilst a correlation may be made with low levels of R&D investment, or minimal levels of innovation, significant pockets of success can be evidenced. AEC as a whole will need to continually change - particularly cognisant of new social, environmental and economic demands. It will also have to address additional pressures such as: increased client demands, stringent performance criteria, low productivity and lack of innovation (to name but a few). The culmination of these issues continues to affect the industry's image. Acknowledging these issues, in order to address some of these factors, a solution in the form of an Industry-Academia Engagement Interface Model was presented for discussion. The authors proffer that whilst not technically perfect [at this stage of development], it does however offer fervent avenues for further exploration. The adoption of successful embedded solution garnered from other industries is the first stage in this process. It should be noted at this juncture that this is just the starting point - the discussion from which forms the basis of wider research on AEC-Industry engagement which will be reported in later works.

5. REFERENCES

- Akintoye, A., Goulding J.S., and Zawdie, G., (2012), Construction Innovation and Process Improvement, Wiley-Blackwell, UK, Print ISBN: 9781405156486; Online ISBN: 9781118280294; DOI: 10.1002/9781118280294
- Australian Government, (2017), Building and Construction, available from <https://industry.gov.au/industry/IndustrySectors/buildingandconstruction/Pages/default.aspx> [accessed 29 June 2017]
- Banwell, H (1964), Report of the Committee on the Placing and Management of Contracts for Building and Civil Engineering Works, HMSO, UK
- Cision (2016). Growth Opportunities in the Global Construction Industry 2016-2021: Trends, Forecast, and Opportunity Analysis. [online] Available at: <https://www.reportbuyer.com/product/4111764/growth-opportunities-in-the-global-construction-industry-2016-2021-trends-forecast-and-opportunity-analysis-august-2016.html> [Accessed 28 June 2017].
- Constructing Excellence. (2017). Teamworking. Available at: <http://constructingexcellence.org.uk/resources/teamworking/> [Accessed 28 June 2017].
- Egan, J (1998), Rethinking Construction, Department of the Environment Transport and Regions (DETR), UK http://constructingexcellence.org.uk/wp-content/uploads/2014/10/rethinking_construction_report.pdf [Accessed 29 June 2017].
- Egan, J. (2008). Egan: I'd give construction about 4 out of 10. Available at: <https://www.bre.co.uk/filelibrary/pdf/CLIP/SirJohnEgan21-05-08.pdf> [Accessed 29 June 2017].
- Fairclough, J (2002) Rethinking construction innovation and research: A review of government R and D policies and practices, Department of Trade and Industry, London.
- Forbes, (2016) Sixth Annual List of the World's Most Innovative Companies 2016, available from www.forbes.com/sites/forbespr/2016/08/24/forbes-releases-sixth-annual-list-of-the-worlds-most-innovative-companies/ [accessed 29 June 2017]
- Geletkanycz, M (1997), The Salience of 'Culture's Consequences': the Effects of Cultural Values on Top Executive Commitment to the Status Quo, Strategic Management Journal, Vol. 18, Part 8, pp 615-634
- JLL (2017), Jones Lang LaSalle, US Trends an Outlook Q3 2016, available from www.us.jll.com/united-states/en-us/research/us-construction-perspective [accessed 29 June 2017]

- Johnson, G (1992), Managing Strategic Change – Strategy, Culture and Action, *Journal of Long Range Planning*, Vol. 25, Part 1, pp 28-36
- Kahan, S., (2013), *Getting Innovation Right. How Leaders Leverage Inflection Points to Drive Success*, San Francisco: Jossey-Bass.
- Kotter, J.P., (2012). *Leading Change*. Boston, Mass.: Harvard Business Review Press.
- Latham, M., (1994). *Constructing the Team*, HMSO, London, UK
- Lewin, K (1947) *Frontiers in Group Dynamics: Concept, Method and Reality in Social Science, Human Relations* 1: pp 5-41.
- Mullins, L.J., (2010). *Management and Organisational Behaviour*. Essex: Prentice Hall
- Powers, D.R., Powers, M.F., Betz, F., and Aslanian, C.B., *Higher Education in Partnership with Industry*, Jossey-Bass Publishing, San Francisco, USA
- Science Business Innovation Board AISBL (2012). *Making Industry-University Partnerships Work*, Available from <http://sciencebusiness.net/Assets/94fe6d15-5432-4cf9-a656-633248e63541.pdf> [accessed 29 June 2017]
- Scouller, J, (2011), *The Three levels of Leadership*, Management Books 2000 Ltd, Cirencester, UK
- Sexton, M. and Barrett, P., (2003). A Literature Synthesis of Innovation In Small Construction Firms: Insights, Ambiguities and Questions. *Construction Management and Economics*, Vol. 21, No.6, pp. 613–622.
- Slaughter, S. (1998), Models of Construction Innovation, *Journal of Construction, Engineering and Management*, 124 (3), pp 226-231
- SMMT. (2017). *Technology & Innovation - SMMT*. [online] Available at: <https://www.smmt.co.uk/industry-topics/technology-innovation/> [Accessed 28 June 2017].
- UK Commission for Employment and Skills, (2013). *Technology and Skills in the Construction Industry*, Available at <https://www.gov.uk/government/publications/technology-and-skills-in-the-construction-industry> [accessed 29 June 2017]
- University of Oxford. (2017). *Frascati Support*. [online] Available at: <https://www.admin.ox.ac.uk/researchsupport/applying/frascati/> [Accessed 28 Jun. 2017].
- Winch, G.M., (2003). How Innovative Is Construction? Comparing Aggregated Data On Construction Innovation and Other Sectors – A Case of Apples and Pears. *Construction Management and Economics*, Vol. 21, No.6, pp. 651–654.
- World Economic Forum (2016). *Shaping the Future of Construction*.
- Young, E (1989), On the Naming of the Rose: Interests and Multiple Readings as Elements of Organisational Culture, *Journal of Organisational Studies*, Vol. 10, Part 2, pp 187-206

INTEGRATING FACILITY MANAGEMENT FUNCTIONS IN BUILDING INFORMATION MODELING (BIM): A REVIEW OF KEY ISSUES AND CHALLENGES

M. K. Dixit and V. Venkatraj

Department of Construction Science, Texas A&M University, College Station, TX, USA

Email: mdixit@tamu.edu

Abstract: Building Information Modeling (BIM) has become a mainstream construction technology being widely used for initial construction of facilities. BIM's data-rich structure allows quickly analyzing and sharing construction information across key players of a construction project. The use of BIM has been mandated in countries such as the United States for most public buildings' design and construction and, in most cases, it is now required for the general contractors to submit not only the as-built drawings but also as-built BIM. Using an as-built BIM, any information required by facility managers can be extracted, processed, and returned to the model for quickly and easily evaluating and making life-cycle decisions. Despite BIM models containing important design, construction, and building system information, its application to facility management (FM) function and decision-making has been limited. There are unresolved issues and challenges to integrating FM functions into BIM. Some of the issues relate to the limitation of modeling a facility's discipline-specific information needed for FM decision-making, some are associated with the interoperability of available tools. Several studies have discussed and underscored major issues and challenges to integrating FM functions into BIM. Studies also proposed models or tools that partially integrate FM functions into BIM. In this paper, we conduct a rigorous review of literature to identify key information exchange-related and methodological issues that are hampering the process of BIM-FM integration. We discuss and analyze identified issues to propose a possible solution in the form of FM-BIM framework.

Keywords: BIM, Challenges, FM, Interoperability, Legal, Process-Based

1. INTRODUCTION

The construction sector is constantly evolving to provide value for money, faster project delivery, a safe and productive workplace, and efficient life cycle management. This has accelerated the adaptation of Building Information Modelling (BIM) to perform various construction operations (Arayici et al., 2010). BIM is a virtual database that helps various stakeholders collaborate and communicate during a project's lifecycle (Naghshbandi, 2017). Using a BIM to perform construction operations has shown significant benefits in terms of productivity, efficiency, and quality control (Azhar et al., 2011 and Arayici et al., 2010). Some of the applications of BIM are visualization, code reviews, estimating, construction scheduling, clash detections, and facility management (FM) (Azhar et al., 2011). FM is a phase of the building's lifecycle that involves real estate and financial management to maintain a facility (Kelly et al., 2013). Speaking particularly about FM, BIM data help in commissioning, closeout, space management, locating building components, quality control, energy management, maintenance and repair, and security management (Becerik-Gerber et al., 2011). Although the use of BIM has significantly increased over the years, its use during the FM phase of a building seems to be extremely limited (Kiviniemi and Codinhoto, 2014). This can be attributed to a multitude of factors such as, the owner's attitude; most of the owners are only concerned with the initial project costs. Hence, the owners fail to envision the subsequent costs that they may incur during the operations and maintenance (O&M) phase of the building (Love

et al., 2014). In addition, facility managers must be involved in developing the BIM from its design stage which is currently not the common practice (Becerik-Gerber et al., 2011). In recent years, researchers have given significant attention to integrating BIM with the pre-construction and construction phases of a project. However, there is extremely limited insight on the applications of BIM to FM (Kelly et al., 2013). This paper explores the various issues with integrating FM functions into BIM, the key-players responsible for these issues and identifying potential instances where BIM data would benefit facility managers. The key-players include the manufacturers, design professionals, general contractors, construction managers, clients/owners, and facility managers. Such a comprehensive review of literature would provide FM professionals the information to generate a standardized framework that would resolve these issues and ensure complete utilization of BIM to its full potential.

2. RESEARCH OBJECTIVES, METHODS AND SIGNIFICANCE

The main goal of this review paper is to identify what is impeding a successful integration of FM functions into BIM. The goal will be reached through two research objectives:

- Identify key issues that hinder the integration of FM functions into BIM by conducting a rigorous review of literature
- Determine the sources of these issues and suggest suitable measures to address them

We preferred to use the literature review approach to first create a knowledge base reflecting the state-of-the-art of research in the field. In the next phase, we plan to conduct a survey of FM professionals to evaluate and validate the findings of the literature review. An exhaustive search was performed on Google Scholar using the following keywords: Revit, BIM, FM, BIM for O&M, COBie, dynamic maintenance of BIM, fragmentation, FM information transfer formats, interoperability, key-player's, etc. To keep the search exhaustive, we continued until relevant publications stopped showing up in the search engine. To keep the results relevant to current time, we focused mainly to the last decade. This search resulted in collecting over 54 research papers (n=54) between the years 2008 and 2017. We reviewed and analyzed the information obtained from the sourced journal papers, conference proceedings, government documents, industry reports, and other articles. We included studies that considered the use of BIM during the FM phase and not during the entire lifecycle of the building. Such cases were particularly selected to understand the key issues and barriers that prevent the implementation of BIM only during the O&M phase that relates closely to FM functions. This analysis eventually led to formulating a matrix that helped us identify certain patterns and repetitions of FM-BIM issues highlighted by various studies.

The *2015 Measuring the Impacts of BIM on Complex buildings SmartMarket Report* (Jones et al., 2015), shows that while 86% of the owners receive building information models upon project completion; only 17% of the times the model is used for FM. This is because most owners see the benefits of BIM in the design and construction phase, however they fail to understand the significance of using the BIM during the O&M phase. We presume that this paper would provide certain insight regarding the benefits of using BIM for FM and the key issues that prevent their integration.

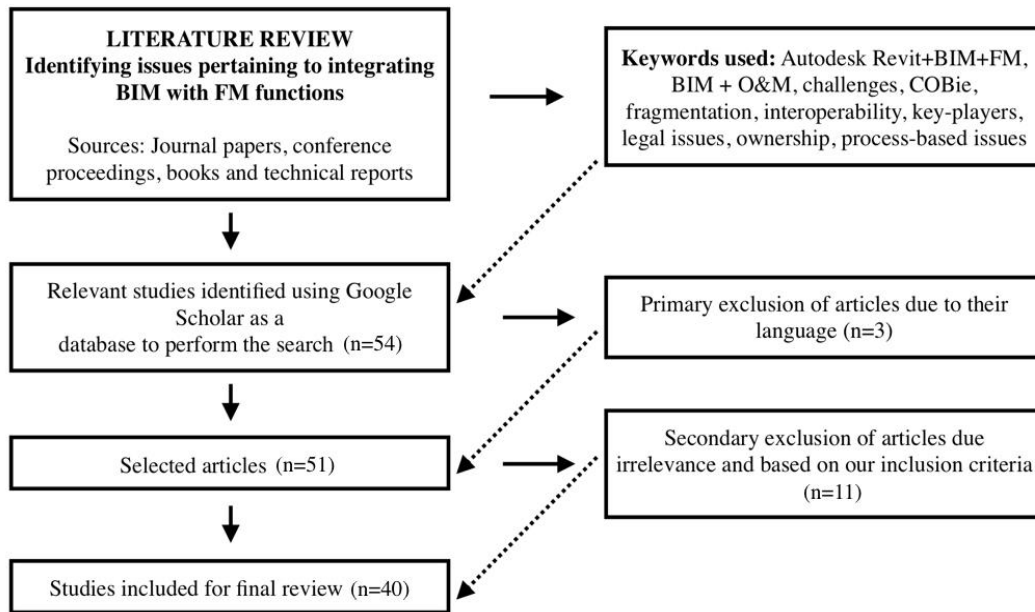

Figure 1: Research Methodology

3. RESEARCH FINDINGS

The review of literature resulted in numerous issues hindering the integration of BIM and FM on a large scale. We categorized them in the following six categories:

3.1 Information management issues

This issue mainly relates to the ambiguity and the lack of information required to use BIM for FM functions. Liu & Issa (2013) highlighted some information management issues, which are: (i) O&M data are hard to locate, (ii) procuring details about the MEP details, specifications and warranty in the correct format is difficult, (iii) unavailability of O&M manuals, and (iv) obtaining updated as-built plans. Several studies also show that improper management of information during the design and preconstruction phases severely disrupts workflow for the rest of the project's lifecycle. The study by Pärn et al., (2017) showed that designers focus on using BIM for clash-detections during the design phase and fail to envision future O&M requirements. We found the following two areas of information management hampering the FM-BIM integration:

(i) *Information Capture*: The volume of data increases from the top (design phase) to bottom therefore, making it essential to capture, track, and identify data throughout the construction process. Data that would be essential to capture during the design process are manufacturing data, specifications, operational instructions, procedures, and warranty information (Becerik-Gerber et al., 2011). Currently, capturing this data is an extremely tedious process since the nomenclature, numbering style, semantics, syntax, and schema vary when information is transferred from one player to another. In addition, no specific formatting guidelines are available to cohesively link BIM with the FM systems (Becerik-Gerber et al., 2011). The industry also lacks a framework to outline clearly the level of detail (LOD) of information capture required for BIM, which causes delays in processing information (Parsanezhad & Dimyadi, 2013). Over time, the increasing volume of data and incompatible data formats lead to “data disintegration” over a building's lifecycle. This results in loss of information, which

can be attributed to the involvement of multiple stakeholders and the fragmentation within the building industry (Liu & Zettersten, 2016). These issues arise mainly during the design and construction phase. Some suggestions to resolve these issues are: (i) increasing transparency amongst the stakeholders, and (ii) manufacturers need to develop a standardized protocol for information capture. This would help in enhancing the decision-making process within FM functions.

(ii) Updating Information in the BIM: A BIM needs to be dynamically updated in real time, with the most recent changes to make it usable for the facility managers (Beach et al., 2017; Naghshbandi, 2017; Kelly et al., 2013 and Becerik-Gerber et al., 2011). However, since owners make decisions regarding the maintenance plans, no feedback occurs amongst the owner, contractor, and designer, ending the feedback loop post-handover (Liu & Zettersten, 2016). The quality of data also depends upon how regularly the model is updated and the skill of the person inputting the data (McAuley, 2016; Vanlande et al., 2008). In addition, updating facility maintenance data is still a manual process, which can take up to two years to enter data, particularly on larger projects (Liu & Zettersten, 2016). BIM also include data that may not be relevant to facility managers. A sudden exposure to large amounts of irrelevant data overwhelms facility managers causing delays and errors in maintaining and managing data (Kang & Hong, 2015). Loading the model with redundant and irrelevant information may reduce its usability and performance over time (IFMA, 2013). The inefficiency associated with updating data is due to: (i) paper based media, (ii) data duplication and re-entry, and (iii) inability of mobile devices to update necessary information (Lin et al., 2014 and Lin & Su, 2013). Issues pertaining to updating information in BIM begin during the design and construction phase due to the improper communication amongst various stakeholders. These issues also exist because the owner is not aware of the changes made during the O&M phase of the building. Integrating updated FM information with a BIM across the various stages of a project will help in saving time and cost. This information will assist facility managers in decision making, locating the faulty equipment and resolving the problem faster (Mignard & Nicolle, 2014; Wang et al., 2013). Therefore, it is extremely important to predict the information requirements of a facility for its entire lifecycle.

3.2 BIM execution issues

Current BIM execution methods and workflows are inefficient and ineffective for the purpose of FM functions (Love et al., 2014). Owners are more interested in obtaining information related to the geographic location, construction costs, and schedule rather than being concerned about the complications arising during the O&M phase (Love et al., 2014). BIM execution issues mainly include: (i) unclear BIM structure and legal responsibilities amongst key-players, and (ii) interruption of BIM workflow by lack of client demand. Other issues raised in certain studies include resistance to BIM implementation at cultural and operational levels (McAuley, 2016 & Eadie et al., 2013).

(i) Unclear BIM structure and legal BIM responsibilities amongst key players: The successful implementation of BIM processes in a construction company requires a transfer of highly confidential information among the various stakeholders in a secure manner (Eadie et al., 2013). However, personnel have undefined roles and responsibilities for updating and maintaining the model due to unstandardized BIM workflow processes (McAuley, 2016; Kelly et al., 2013; Wang et al., 2013 and Becerik-Gerber et al., 2011). This lack of standardization eventually results in building professionals working independently and redundantly (Elmualim

& Gilder, 2013). Additionally, the lack of mechanisms for controlling and verifying data entered into the model might produce inaccurate models (Lin & Su, 2013 and Kasprzak et al., 2013). The problem is further aggravated by the reluctance of key players to share information with different teams (Eadie et al., 2013). Facility managers are not included in the process until the final stages of the building's lifecycle (Love et al., 2014). Worse, no legal BIM execution guidelines are in place for updating and maintaining a model (Kelly et al., 2013). The lack of specific guidelines, also hampers the process of outsourcing BIM services to external BIM service providers, since BIM servers are not obligated to any legal contracts (Beach et al., 2017). Hence, it is critical to contractually understand the legal responsibilities of various participants within the project (Liu, 2010). This makes it extremely difficult to gather usable FM data from the developed BIM during the design and construction stage. Thus, it becomes the duty of the BIM coordinator to assign responsibilities to the individuals working in a team. This will help in determining who will significantly influence the use of BIM and how efficiently the team can be organized to enhance the use of BIM.

(ii) Lack of client demand: The benefits of BIM for FM functions are not well understood by clients due to misinformation or the unavailability of sufficient literature. Owners are also sceptic regarding its potential usage (McAuley et al., 2015; Wang et al., 2013; Arayici et al., 2012). Often, clients do not request for BIM models for FM, giving the designers no incentive to maintain the model. This is because the client often fails to perceive how the end-users will use the facility (Elmualim & Gilder, 2013). Here, it is important for the building professionals to emphasize upon the importance of adopting BIM during the O&M phase to the owner. This will help in creating an information database for quicker and efficient FM decision making.

3.3 Interoperability issues

Interoperability is defined as “the ability of a software program to exchange data between various applications to facilitate automation and avoid data re-entry” (Azhar et al., 2012). Issues of interoperability mainly occur due to: (i) incompatible data exchange formats, (ii) availability of multiple software platforms, and (iii) incompatibility between FM and BIM technologies.

(i) Incompatible data exchange formats: Building owners struggle while using a new application mainly because of interoperability issues during the transfer of information between two different formats of the application (Mayo et al., 2012). For example, the information transfer between Solibri Model Checker (SMC) and Autodesk Revit always loses some of the information in the IFC format (Liu & Issa, 2014). Even the use of a middleware program to facilitate software integration (while using software such as Autodesk Revit, Bentley BIM, and IBM Maximo) might result in miscommunication, loss, and liability (IFMA, 2013). Interoperability issues are also experienced during the process of document collection. Usually, digitally created documents are distributed to personnel working onsite. These documents are later collected and scanned to save as an image in a digital format. Later, retrieving these images to update the existing BIM becomes a tedious task (Goedert & Meadati, 2008). Special care needs to be taken by the software developer to understand the requirements of the user. The above-mentioned issues could lead to data disintegration over the building's lifecycle (Liu and Zetterson, 2016). Currently, the building industry is taking rigorous efforts to establish standardized protocols such as Industry Foundation Classes (IFC), Information Delivery Manuals (IDM) etc. to prevent such problems (Jung & Joo, 2011). The construction sector is

also trying to move towards completely digitalized information exchange systems to prevent issues of interoperability (Steel et al., 2012).

(ii) Availability of multiple software platforms: The availability of many toolsets for BIM and FM integration lead to interoperability issues (McAuley, 2016 and Becerik-Gerber et al., 2011). The software platforms used for integrating BIM and FM functions include; CAFM (Computer Aided Facility Management), CAD (Computer Aided Design), IWMS (Integrated Workplace Management Systems), and CMMS (Computerized Maintenance Management System). A study performed by Kivits & Furneaux, (2013) also emphasized using a single standard software in all construction companies. However, this is almost impossible because most of the construction projects differ in terms of complexity, building typology, and geographic location. Building professionals are also working in different locations following different norms, practices, languages, and software platforms to collaborate and communicate (Liu & Zettersten, 2016 and Parsanezhad & Dimyadi, 2013). Here, the software developer must be aware of the complexities involved in modelling a construction project. This will help in developing a single comprehensive platform to perform all construction functions. Providing a consistent software platform will ensure standardized information flow across FM players.

(iii) Incompatibility between FM and BIM technologies: Interoperability issues between existing FM technologies and BIM technologies causes problems while transferring information during the operation stage (McAuley, 2016). For example, extracting information from a BIM, into a CAFM system causes overloading of information (McAuley, 2016). To resolve this issue, COBie (Construction Operations Building Information Exchange) is used as a platform to structure available data. COBie is a standardized format used for digitalized information exchange across various construction and FM phases (Anderson et al., 2012). However, “COBie does not provide details on what information is to be provided, when and by whom” (Kelly et al., 2013). Furthermore, other systems such as building automation systems (BAS) are not compatible with the BIM model and FM databases (IFMA, 2013). Over time, these interoperability issues reduce the overall interaction between various stakeholders by a considerable amount leading to fragmentation in the Architectural, Engineering, Construction and Operations (AECO) industry (Utiome, 2015). This issue can be addressed by developing plugins or API's (Application Program Interface) for data transfer from standard software platforms to FM tools. The reason for the gap in developing an add-in to the existing software is mainly due to an inadequacy of technological support (Liu & Issa, 2013).

3.4 Technological issues

Issues related to technology occur due to several reasons, which include: (i) long adaptation times, (ii) software issues, and (iii) large file sizes.

(i) Long adaptation times: The AECO and FM industry suffers due to long adaptation periods towards new technology (Kivits & Furneaux, 2013). The gradual transition from using paper based documents to using COBie and BIM results in a hybrid of paper and digital information media. This makes it difficult for the building professionals to access, track, authenticate, or trust the source of information (Anderson et al., 2012). This transition also changes the method of retrieving information from a database. Earlier, most users retrieved information from their peers or other people-based networks. Now, users have to retrieve information from a large digital repository using a digital format (Anderson et al., 2012). These factors prevent the holistic integration of COBie into BIM (Beach et al., 2017; Elmualim & Gilder, 2013).

(ii) Software issues: Firstly, most of the software applications have a complex interface and are cumbersome and non-intuitive. Building professionals also do not invest time to implement alternate software solutions (Anderson et al., 2012). Secondly, the development of new applications requires technical skills as well as construction knowledge and experience. Since very few software developers possess the knowledge regarding both, it becomes extremely difficult to predict a user's needs (Liu and Zettersten, 2016). Thirdly, since many individuals work on the same BIM project, it requires a multi-user access to the model, which is currently not well developed (Azhar et al., 2012). Fourthly, multiplicity of vendor's lead to creating different information regarding the same equipment (Utiome, 2015). A study by Manning & Messner (2008) cited the need for creating standardized parametric objects and families to prevent such issues. Finally, most of the FM organizations already have a software platform to manage their FM data. Integrating information of newer buildings on a new system becomes tedious and time consuming (Kiviniemi and Codinhoto, 2014). At times, newer versions of the software's are not compatible with their older versions. For example, a model created using Revit 2017 will not open on the Revit 2015 version . Very often, details provided by a designer to a client is radically different from the information required to perform construction on-site. Therefore, the software must be able to create different construction templates from the same model based on the user's requirement (design, construction or FM). Developing such templates to transfer data in the required format might help in increasing the efficiency of the construction process.

(iii) Large file sizes: BIM involves transferring data of large volumes with on onsite and off-site personnel. This becomes extremely tedious due to technical reasons (Kivits & Furneaux., 2013). Even though, BIM software such as Autodesk Navisworks can manage large volumes of information, it takes 2 to 5 minutes for the model to download a whole BIM. The downloaded file is much larger than the original BIM file, making the accessibility of the file difficult for onsite personnel (Liu & Su, 2013). In addition, if a user can access a BIM model only on desktop computers, it limits their use onsite during maintenance and management services (Lin et al., 2014; Liu & Su, 2013). For this, changing the file format to a smaller version might help in dealing with the storage constraints of small mobile devices. During construction, real-time updates of BIM using mobile devices will help in increasing the quality of FM data and producing more accurate as-built drawings.

3.5 Cost based issues

A study performed by Azhar et al. (2012), shows that 85% of the lifecycle cost of a facility occurs during the O&M phase. Annually, around \$10 billion is lost due to improper data access and interoperability issues. Cost based issues include: (i) cost associated with training BIM consultants, (ii) cost associated with information management, and (iii) unperceived cost benefits of using BIM.

(i) Costs associated with using training BIM consultants: Administrative costs usually increase using BIM, since it requires more time inputting and reviewing BIM data (Beach et al., 2017; Azhar et al., 2011 and Talebi, 2014). Apart from administrative costs, training personnel to use BIM tools and improve their BIM skills adds to the initial cost (Eadie et al., 2013 & Liu, 2010). In addition, sufficient time and human resources needs to be allocated to the training process, which acts as a substantial barrier with the construction sector to use BIM for FM functions (Mishra & Mishra, 2014). Investing and allocating sufficient funds during the preconstruction phase, might help in eliminating the issue and saving costs in the long-run.

(ii) *Costs associated with information management:* Earlier, information describing the equipment warranty, parts list, etc. was generally exchanged using paper documents. At present, these inputs need to be keyed into relevant data systems thereby increasing the overall cost (East & Brodt, 2007). Facility managers also spend a lot of time in verifying, locating, and separating useful data from the rest, since raw data is not properly segregated (Kang & Hong, 2015). In addition, building owners pay twice, once to the construction contractor for the set of complete documents at end of construction and once to facility maintenance contractors to capture updated as-built conditions (East & Brodt, 2007). This can be attributed to the failure to invest in BIM for FM during the earlier stages of a project (Elmualim & Gilder, 2013). The effects of increased costs are experienced in the design, construction and post-occupancy phases. If these costs are managed properly, it adds value to the company.

(iii) *Unperceived cost benefits of using BIM:* Clients and designers are apprehensive of investing in a new technology because the economic benefits of BIM does not have substantial proof (Talebi, 2014). Here, there is a trade-off between the stakeholder who invests in BIM technology and the stakeholder who will be benefitted by it. While the designer pays the price for implementing BIM in the construction process, only the owner of the facility is directly benefitted (Kivits & Furneaux, 2013). The study conducted by Beach et al., (2017), shows that a single BIM document can inform companies regarding storage costs for the duration of their project. However, many companies fail to implement them due to that uncertainty associated with their use. Building designers and owners do not invest in post evaluation occupation (POE) of their assets, since there are no guidelines regarding the payment procedure of conducting such studies (Elmualim & Gilder, 2013). Although, designers are ready to invest in BIM, an absence of real world cases and positive return on investments acts as an obstacle to overcome for the full-fledged implementation of BIM for FM functions (McAuley, 2016 and McAuley et al., 2015).

3.6 Legal and contractual issues

Legal and contractual issues mainly occur due to the following reasons: (i) Who will own the BIM data (Beach et al., 2017; Talebi, 2014; Volk et al., 2014; Eadie et al., 2013; Kelly et al., 2013 and Azhar et al., 2011) (ii) How to protect its copyright (Volk et al., 2013 and Kelly et al., 2013) (iii) Who will take responsibility for the BIM model (Beach et al., 2017 and Azhar et al., 2012) (iv) Risk Allocation (Kivits & Furneaux., 2013) and (v) Privacy & third party reliance (Kivits & Furneaux., 2013). The issues discussed in our study are: (i) ownership and responsibility of BIM data, (ii) contractual and compliance issues, and (iii) cyber security and privacy

(i) *Ownership and responsibility of BIM data:* A BIM model essentially consists of a single complex file that is altered by several individuals during the construction process (Kivits & Furneaux., 2013). In most of the cases, the designer is responsible for creating the model that will be used throughout the construction process. However, since multiple stakeholders control the input of data into the model, no single person can be responsible for any discrepancies. Therefore, there is a high risk associated updating the BIM accurately (Azhar et al., 2011). The study by Liu (2010), emphasizes on the problems of joint ownership of a BIM amongst project participants due to unclear legal responsibilities. Several studies also show that the process of categorizing information and transferring only the required information to the owner is cumbersome. According to the American Institute of Architects (AIA) regulations, the BIM model is eligible only for a limited reuse (IFMA, 2013). The design professionals might

become liable to issues emerging from reuse and modifications of the model. Therefore, it becomes critical to understand how the model will be used to address liability concerns due to data exchange (IFMA, 2013). Assigning ownership at the beginning of the project will ensure smoother workflows and enhance the decision-making process.

(ii) Contractual and compliance issues: The contractual documents are mostly paper based documents that are reviewed, sealed and signed. They include equipment lists, product data sheets, operations and maintenance manuals, warranties, spare parts sheets and other specification lists (Kelly et al., 2013). Often, the 2-D contractual documents are generated from the model (IFMA, 2013). This can very often lead to accessibility concerns, confusion and misleading transfer of information, making it difficult to improve FM efficiencies (Kelly et al., 2013). Therefore, building professionals must be sure to capture the most precise as-built conditions, otherwise they might become legally liable. Having a staff authority to guide building professionals throughout the construction process might help in resolving these issues.

(iii) Cyber security and privacy: BIM consultants also find issues while trying to integrate technology with the BIM processes. For example, making the BIM model a part of the extranet might lead to legal repercussions (Eadie et al., 2013). In some cases, using electronic environments to manipulate data for tendering, causing doubts in its authenticity (Kivits & Furneaux., 2013). Furthermore, the use of an external server, middleware software or cloud – storage might lead to an information security breach. This prevents the construction industry’s transition to completely digitalized environments. Therefore, it is critical for the software developers to provide applications that would ensure safety and security of confidential information.

Table 1 illustrates a framework of the above-mentioned issues along with possible players who can help address the issues, relevant project phase, suggested methods to resolve the issue, and benefits to FM industry. This framework is significant to systematically address each issue by involving key players in establishing guidelines for data transfer across various life cycle phases. For instance, the issue of interoperability can be easily resolved by bringing together BIM software developers. Similarly, cost-based issues can be addressed by owners, particularly when they are informed by a framework such as the one shown in Table 1. The framework not only communicates the issue but also shows benefits if it is applied successfully.

Table 1: Summary

Type of issue	Keyplayer responsible	Phase the error occurs	Method to solve the issue	Benefits to FM
Information Management Issues				
Information capture	Multiple stakeholders	Design & Construction	Increasing transparency and generating a standard protocol information capture	Faster decision making
Updating Information in the BIM	Multiple stakeholders --- Owners -----	Design & Construction Post occupancy	Change manually entered FM data to become automated	Increases quality and efficiency of FM functions
BIM Execution Issues				
Unclear BIM workflow and responsibilities	BIM coordinator	Design, Construction, O&M	Develop a framework using an advisory council	Increases authenticity of the developed BIM model
BIM workflow interrupted by lack of client demand	Owner	Post occupancy	Emphasize upon the importance of BIM for O&M to the owner	Saves time and cost
Interoperability Issues				
Incompatible data exchange formats	Software developer	Design & Construction	Software developer needs to understand the requirements of the end user	Prevents data disintegration and loss of essential information when a project transitions from phase to phase
Availability of multiple software platforms	Software developer	Design & Construction	Provide consistent software platform to perform all functions	Ensures standardized information flow across FM players
Incompatibility between existing FM technologies and BIM technologies	Software developer	Design & Construction	Plugins/APIs to be developed for data transfer from standard software platforms to FM tools	Will help in preventing fragmentation in construction
Technological Issues				
Lack of adaptability	Building personnel	Design & Construction	Need to be more open regarding the use of new software applications	Saves time and cost
Lack of protocols or Standardization	Software developer	Software development phase	Develop framework	Limits inconsistencies and helps in formulating a standard for the entire building industry
Multiple software versions	Software developer	Design & Construction	Provide versions of software that are compatible with older versions	Increases efficiency and quality control
File size	Software developer	Construction	Mobile devices must be allowed to update data into the BIM	Increases communication and collaboration keyplayers which creates an accurate BIM
Cost Based Issues				
Training costs	Administration	Design	Allocate funds in the beginning	Adds value to the company
Unperceived costs benefits of using BIM	Owner	Post occupancy	Substantiate with sufficient literature to show benefits of BIM in performing FM functions	Saves time and cost
Contractual Issues				
Ownership and responsibility of BIM data	Multiple stakeholders	Design	Assign ownership at the beginning of the project	Faster decision making
Contractual and Compliance Issues	Multiple stakeholders	Design, Construction, O&M	Develop all documents in a single media (either paper or digital) not both	Faster decision making
Cyber security and risks	Multiple stakeholders	Design, Construction, O&M	Increase security	Increases authenticity

4. CONCLUSIONS

Over the last decade, BIM technology has been extensively used in various geographic locations for various construction phases. However, its usage over the O&M phase seems to be limited due the issues discussed above. The review of literature clearly indicates several obstacles that are faced in integrating BIM with FM. It has also helped us identify specific instances at which facility managers would be benefitted by the updated BIM data. The major challenge is that the AECO industry is extremely fragmented and lacks a standard framework that will guide the industry to operate cohesively. As individuals working in the construction sector, it is our responsibility to understand the potential of using BIM to enhance the experience of the final user. This paper has systematically documented prevalent issues, significant gaps existent in the industry and suggested possible solutions to resolve these issues. Several issues can be addressed by specific building professionals who are related to the on-going construction process. Future research can be conducted to frame suitable guidelines or

develop a construction template which will define the information organizational structure thereby, enabling the complete utilization of BIM over the building's lifecycle.

5. REFERENCES

- Arayici, Y., Coates, P., Koskela, L., Kagioglou, M., Usher, C. and O'reilly, K., 2011. Technology adoption in the BIM implementation for lean architectural practice. *Automation in Construction*, 20(2), pp.189-195.
- Naghshbandi, S.N., 2017. BIM for Facility Management: Challenges and Research Gaps. *Civil Engineering Journal*, 2(12), pp.679-684.
- Azhar, S., 2011. Building information modeling (BIM): Trends, benefits, risks, and challenges for the AEC industry. *Leadership and management in engineering*, 11(3), pp.241-252.
- Kelly, G., Serginson, M., Lockley, S., Dawood, N. and Kassem, M., 2013, October. BIM for facility management: a review and a case study investigating the value and challenges. In *Proceedings of the 13th International Conference on Construction Applications of Virtual Reality* (pp. 30-31).
- Becerik-Gerber, B., Jazizadeh, F., Li, N. and Calis, G., 2011. Application areas and data requirements for BIM-enabled facilities management. *Journal of construction engineering and management*, 138(3), pp.431-442.
- Kiviniemi, A. and Codinhoto, R., 2014. Challenges in the implementation of BIM for FM—Case Manchester Town Hall complex. In *Computing in Civil and Building Engineering (2014)* (pp. 665-672).
- Liu, R. and Issa, R.R.A., 2013. Issues in BIM for Facility Management from Industry Practitioners' Perspectives. In *Computing in Civil Engineering (2013)* (pp. 411-418).
- Pärn, E.A., Edwards, D.J. and Sing, M.C.P., 2017. The building information modelling trajectory in facilities management: A review. *Automation in Construction*, 75, pp.45-55.
- Parsanezhad, P. and Dimyadi, J., 2013. Effective facility management and operations via a BIM-based integrated information system.
- Liu, R. and Zettersten, G., Facility Sustainment Management System Automated Population from Building Information Models. In *Construction Research Congress 2016* (pp. 2403-2410).
- Beach, T., Petri, I., Rezgui, Y. and Rana, O., 2017. Management of Collaborative BIM Data by Federating Distributed BIM Models. *Journal of Computing in Civil Engineering*, p.04017009.
- McAuley, B., 2016. Identification of Key Performance Tasks to Demonstrate the Benefit of Introducing the Facilities Manager at an Early Stage in the Building Information Modelling process on Public Sector Projects in Ireland..
- Vanlande, R., Nicolle, C. and Cruz, C., 2008. IFC and building lifecycle management. *Automation in construction*, 18(1), pp.70-78.
- Kang, T.W. and Hong, C.H., 2015. A study on software architecture for effective BIM/GIS-based facility management data integration. *Automation in Construction*, 54, pp.25-38.
- Teicholz, P. ed., 2013. *BIM for facility managers*. John Wiley & Sons.
- Lin, Y.C., Su, Y.C. and Chen, Y.P., 2014. Developing mobile BIM/2D barcode-based automated facility management system. *The Scientific World Journal*, 2014.
- Lin, Y.C. and Su, Y.C., 2013. Developing mobile-and BIM-based integrated visual facility maintenance management system. *The Scientific World Journal*, 2013.
- Mignard, C. and Nicolle, C., 2014. Merging BIM and GIS using ontologies application to urban facility management in ACTIVE3D. *Computers in Industry*, 65(9), pp.1276-1290.
- Love, P.E., Matthews, J., Simpson, I., Hill, A. and Olatunji, O.A., 2014. A benefits realization management building information modeling framework for asset owners. *Automation in construction*, 37, pp.1-10.
- Eadie, R., Browne, M., Odeyinka, H., McKeown, C. and McNiff, S., 2013. BIM implementation throughout the UK construction project lifecycle: An analysis. *Automation in Construction*, 36, pp.145-151.
- Liu, Z., 2010. *Feasibility Analysis of BIM Based Information System for Facility Management at WPI* (Doctoral dissertation, Worcester Polytechnic Institute).
- Kasprzak, C., Ramesh, A. and Dubler, C., 2013. Developing standards to assess the quality of BIM criteria for facilities management. In *AEI 2013: Building Solutions for Architectural Engineering* (pp. 680-690).
- Elmualim, A. and Gilder, J., 2014. BIM: innovation in design management, influence and challenges of implementation. *Architectural Engineering and design management*, 10(3-4), pp.183-199.
- McAuley, B., Hore, A. and West, R., 2015. The Development of Key Performance Indicators to Monitor Early Facilities Management Performance Through the Use of BIM Technologies in Public Sector Projects.
- Arayici, Y., Onyenobi, T.C. and Egbu, C.O., 2012. Building information modelling (BIM) for facilities management (FM): The MediaCity case study approach. *International Journal of 3D Information Modelling*, 1(1), pp.55-73.
- Azhar, S., Khalfan, M. and Maqsood, T., 2015. Building information modelling (BIM): now and

beyond. *Construction Economics and Building*, 12(4), pp.15-28.

Mayo, G., Giel, B. and Issa, R.R.A., 2012. BIM use and requirements among building owners. In *Computing in civil engineering (2012)* (pp. 349-356).

Liu, R. and RA Issa, R., 2014. Design for maintenance accessibility using BIM tools. *Facilities*, 32(3/4), pp.153-159.

Goedert, J.D. and Meadati, P., 2008. Integrating construction process documentation into building information modeling. *Journal of construction engineering and management*, 134(7), pp.509-516..

Jung, Youngsoo, and Mihee Joo. "Building information modelling (BIM) framework for practical implementation." *Automation in Construction* 20, no. 2 (2011): 126-133.

Steel, J., Drogemuller, R. and Toth, B., 2012. Model interoperability in building information modelling. *Software and Systems Modeling*, 11(1), pp.99-109.

Anderson, A., Marsters, A., Dossick, C.S. and Neff, G., 2012. Construction to operations exchange: Challenges of implementing COBie and BIM in a large owner organization. In *Construction Research Congress 2012: Construction Challenges in a Flat World* (pp. 688-697).

Utiome, E.A.E., 2015. *Extending building information models to construction specifications* (Doctoral dissertation, Queensland University of Technology).

Manning, R. and Messner, J.I., 2008. Case studies in BIM implementation for programming of healthcare facilities. *Journal of Information Technology in Construction (ITcon)*, 13(18), pp.246-257.

Talebi, S., 2014. Exploring advantages and challenges of adaptation and implementation of BIM in project life cycle. In *2nd BIM International Conference on Challenges to Overcome*. BIMForum Portugal.

Mishra, S. and Mishra, A.K., Benefits and Barriers of Building Information Modelling.

East, W.E. and Brodt, W., 2007. BIM for construction handover. *Journal of Building Information Modeling*, 2007, pp.28-35.

Volk, R., Stengel, J. and Schultmann, F., 2014. Building Information Modeling (BIM) for existing buildings—Literature review and future needs. *Automation in construction*, 38, pp.109-127.

Wang, Y., Wang, X., Wang, J., Yung, P. and Jun, G., 2013. Engagement of facilities management in design stage through BIM: framework and a case study. *Advances in Civil Engineering*, 2013.

Jones, S.S., 2015. Smart Market Report, Design and Construction Intelligence. Dodge Data & Analytics.

A SYSTEMATIC LITERATURE REVIEW ON SUSTAINABLE MANAGEMENT OF THE POST-END-OF-LIFE (PEoL) OF BUILDINGS

R.S Jayasinghe, R. Rameezdeen and N. Chileshe

*School of Natural and Built Environments, University of South Australia, GPO Box 2471, Adelaide
South Australia 5001, Australia*

Email: ruchini.senarath_jayasinghe@mymail.unisa.edu.au

Abstract: Reverse Logistics (RL) and Closed Loop Supply Chain (CLSC) are main concepts related to sustainable management of the Post End-of-Life (PEoL) of a building. Despite a number of literature reviews on RL and CLSC practices, drivers and barriers there is a clear deficiency of knowledge on the interrelationships among these concepts and connected approaches of managing PEoL of buildings. This research provides a Systematic Literature Review (SLR) on PEoL of buildings with the aim of exploring synergies among various concepts that are in place to handle that stage to achieve sustainability. To accomplish the aim, 83 articles have been reviewed and subjected to thematic analysis. SLR elaborates the interrelationships between the main processes of PEoL, its impediments at the implementation and different approaches to overcome the impediments. The paper suggests a comprehensive approach to effectively manage the PEoL stage with the combination of information and effective management practices. The study recommends future research that includes best practices to plan PEoL of building during design, construction and maintenance stages, optimisation models for recovery planning, risk management of the entire PEoL stage and information-based approaches to planning and implementation of PEoL operations.

Keywords: Closed-Loop Supply Chain (CLSC), Post End-of-Life (PEoL) Of Buildings, Reverse Logistics (RL), Strategic Management Approaches, Sustainability

1. INTRODUCTION

The construction industry comprises varieties of stakeholders and operations which are fragmented. The fragmentation results in a lack of coordination, poor communication, lower client satisfaction, low rate of return on investment, lack of functionality and low quality of the product (Albaloushi & Skitmore 2008; Shakantu et al. 2008). Adoption of supply chain management (SCM) principles in construction industry facilitate close collaboration between the stakeholders, trust and transparency thus, enhancing the effectiveness and smooth flow of the construction operations. Supply chain initiates at the client's brief on a particular project, design, construction, maintenance and demolition at the End-of-Life (EoL) of building (Shakantu et al. 2007). This process involves; information, materials, products and stakeholders in each stage. SCM process should concern the organisational and industry level benefits with close consideration of environmental, social and economic impact (Albaloushi & Skitmore 2008). The existing supply chain is, therefore remodified according to sustainable principles and called Green Supply Chain Management (GSCM). GSCM seeks solutions for the waste generation, environmental pollution, energy emission and economic and social impacts from project initiation and up to the EoL building.

End-of-life of a building, however, is not covered by the SCM or GSCM principles. The waste generated due to demolition at the EoL of building create detrimental environment, economic and social impacts (Bevan & Yung 2015; Schamne & Nagalli 2016). The waste is mainly destined to landfill. The waste generation at the demolition stage should adopt a mechanism which systematically and optimally handles the waste during Post End-of-Life (PEoL) of the

building. The mechanism is supported by the concept of “Circular Economy” and the sustainable GSCM principles (Andersen 2007). It persuades reverse supply chain or Reverse Logistics (RL) and Closed Loop Supply Chain (CLSC) which enable the products, components or materials at the EoL of building to re-enter the supply chain as value added inputs to the construction activities or proper disposal of non-value items (Nasir et al. 2016). It facilitates environmental friendly atmosphere, by preserving natural resources and minimising waste. The RL is defined as; “The process of planning, implementing, and controlling the efficient, cost-effective flow of raw materials, in-process inventory, finished goods and related information from the point of consumption to the point of origin for the purpose of recapturing value or proper disposal” (Rogers & Tibben-Lembke 1999, p.2). It links with the concept of CLSC operations by re-generating and maximising the value of products, by reducing detrimental environmental, economic and social impacts. It is a systematic approach to facilitate the maximum value over the life cycle of a material or product using the concept of RL (Govindan et al. 2015). Both the concepts are interrelated and deal with extending the life cycle of materials during PEOl of building to achieve the sustainability.

RL operations start from the demolition or dismantling process at the EoL of the building. Then collection and sorting the salvaged resources at the end of demolition, reprocessing and redistribution of the recovered resources to secondary markets for future construction activities. The PEOl concept and operations have well established in the manufacturing industry (Agrawal, Singh & Murtaza 2015; Hosseini et al. 2014; Pokharel & Mutha 2009). However, it is still in its infancy in the construction industry. The process, therefore, inherits significant barriers, challenges and risks (Chileshe et al. 2015). Recent studies have investigated these issues in the PEOl operations. Comprehensive literature reviews have been conducted to investigate the concept of RL, including its drivers, critical success factors, benefits and barriers (Hosseini et al. 2014; Hosseini et al. 2015a). Several studies have suggested remedial actions such as strategic management approaches to overcome the barriers and to enhance the effectiveness of the process, including, Risk Management (RM), Design for Deconstruction (DfD), Harnessing of Information (HoI), and Design for Reverse Logistics (DfRL), information management systems such as Building Information Modelling (BIM) (Hosseini et al. 2015b; Volk, Stengel & Schultmann 2014). Still, there is room for an in-depth investigation of these novel approaches with their applicability on PEOl of building operations. Particularly on the integration of RL and CLSC concepts, demolition, deconstruction, sorting, reusing and recycling.

Therefore, the Systematic Literature Review (SLR) aims at exploring the synergies between the concepts related to the sustainable management of PEOl operations in the construction industry. To accomplish the aim, following objectives are considered. Firstly to find and map the interrelationships of each concept and develop a conceptual framework. Secondly to establish the future research directions on identified concepts to achieve a sustainable outcome. The paper structured as follows; the first section provides an introduction to the research paper. The second section demonstrates SLR methodology. Third section analyses the selected papers based on thematic analysis method. The fourth section presents the conceptual framework. Finally, the paper presents the future research directions and conclusions.

2. RESEARCH METHODOLOGY

This paper conducts a SLR which provides the essence of widespread knowledge and useful guideline for future research. It facilitates the critical evaluation of the selected literature

sources and synthesising novel concepts (Fink 2013). The research paper has employed a three-phase approach for conducting the SLR, which is depicted in Figure 1.

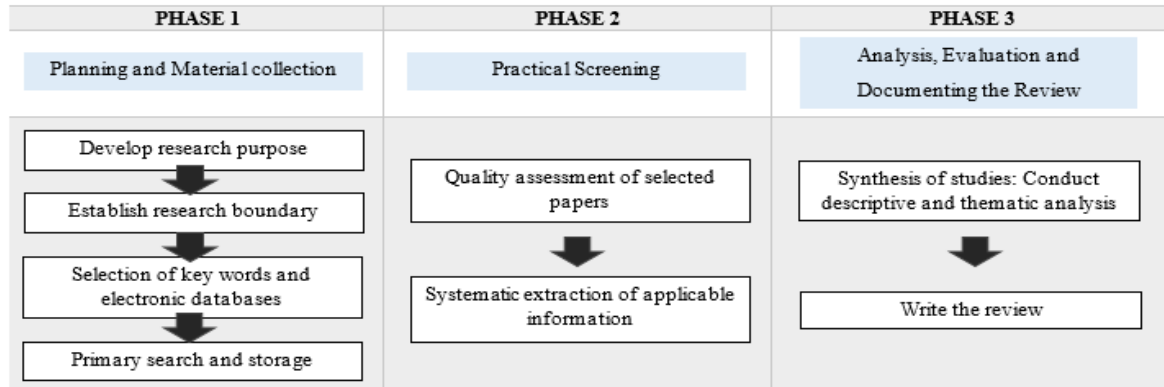

Figure 15: Research Approach

2.1 Phase 1: planning and material collection

Phase 1 develops the research purpose, establishes the research boundary and deals with material selection. Once the research purpose (section 1.0) and the research boundary (main concepts related to the PEOl of building operations) are established, material selection is conducted. Primary search is based on journal article/ book chapter/ conference papers over the period of the year 2006-2016 to ensure the up to date and quality information is indicated. The keywords are searched based on “title/keyword/abstract” under three main stages (Table 1) using electronic databases such as Google Scholar, Scopus (for the purpose of searching articles only in the English language), ProQuest, Web of Science and Science direct.

Table 1: Keyword search

Stage 1	"RL" OR Reverse Supply Chain" "Closed Loop Supply Chain" OR "Closed Loop Cycle"	AND "Construction Industry"
Stage 2	"Deconstruction" OR "Demolition" OR Dismantling, "Salvag"* OR ,"Sort*", OR "Reusing", OR "Recycling", OR "Design for Deconstruction"	AND "Construction Industry"
Stage 3	Risks" OR Uncertainties", "Information Flow" OR "BIM, "Deconstruction" OR "Demolition" OR Recycling" OR "Reusing"	AND "Construction Industry"

2.2 Phase 2: practical screening

The second phase, decides the most suitable articles based on the key concepts, quality assessment of the article and publisher. Articles which have not been peer-reviewed, out of scope, no accessibility and duplication are rejected. Then the primary screening sorted out 276 articles. At the end of the abstract review, 72 articles are selected for full paper review. Then a secondary search, which spots the relevant publications (initially selected abstracts) citing studies (Webster & Watson 2002) is conducted and 64 articles are selected. At the end of

abstract review, 11 articles were selected for full paper review. Total numbers of 83 articles were selected for the full paper review.

2.3 Phase 3: analysis, evaluation and documenting the review

The selected articles are subjected to two types of analysis. Firstly descriptive or statistical analysis is conducted based on the research context, published year, methods and scope (Stone et al. 2008). Then in the thematic analysis, a detailed evaluation is conducted based on the main results of the literature under several areas (Fereday & Muir-Cochrane 2006). This paper mainly discusses the results of the thematic analysis based on five key areas on PEOl of buildings as discussed in Section 3.

3. THEMATIC ANALYSIS

3.1 Development of literature

According to the annual distribution of the main themes related to PEOl of buildings over the period of the year 2006-2016, articles had gradually decreased during first five years and had risen in 2011. Then had an upward trend during last five years. The PEOl of buildings related operations is the most discussed area over last 11 years (55% of articles). During the period articles related to the advanced and proactive approaches (18%) had an upward trend, and 27% of the articles found are related to RL and CLSC concepts. Among them, literature review papers are significant and deal with the origin of RL concept, main terminologies, drivers, practice, barriers (Hosseini et al. 2013a; 2015a; Schamne & Nagalli 2016). PEOl of building operations are still in the infancy stage in construction industry compared to the manufacturing industry. Hosseini et al. (2014) disclose a comparison between these two industries and highlight the lessons learnt for construction industry. Significant consideration is given for barriers related to the RL process and its interrelationships for effective decision making (Chileshe et al. 2015; Rameezdeen et al. 2015). During the last five years articles have suggested decision making models (Chinda & Ammarapala 2016; Chileshe et al. 2016), strategic management approaches such as risk management, and information-based approaches (Example: BIM) (Rajendran & Gomez 2012; Volk, Stengel, & Schultmann 2014), to overcome the impediments against the implementation of PEOl of building operations to achieve sustainable outcomes. Future studies, therefore, should pay attention to those areas. Compared to the RL concept, the concept of CLSC has not been subjected to thorough investigations except few studies on potential barriers and benefits (Wei, Jeske & Schebek 2006; Brennan 2014). Sassi (2008), highlights CLMC concept which is an advanced long-term approach dealing with infinite recycling. These concepts have a potential for further studies to enhance the sustainability of the PEOl of buildings.

PEOl of building operations, such as demolition, deconstruction, sorting reusing and recycling are discussed under different perspectives during 11 years. To overcome the disadvantages of conventional demolition method comparative analysis methods, prototype decision-making models and hybrid approaches have been introduced and practised (Coelho and de Brito 2011; Cha, Kim and Kim 2011; Pun, Liu and Langston 2006). Only one article have found on sorting, as the next step of the PEOl of building operations (Wang et al. 2010). Pre-planning and management of on-site sorting have been suggested as a proactive approach. Reusing and recycling had an upward trend during last five years (da Rocha and Sattler 2009). Compared

to reusing, challenges, barriers and the applications of recycling have been strongly discussed. Notably, the discussion on barriers has become a common research area in recycling (Tam 2009; Tam, Tam and Le 2010; Ignatius & Opeyemi 2014). Recently, the researchers have dealt with implementing new approaches for recycling such as emergy analysis and quantitative documentation and a model for recycling process management (Wu et al. 2016; Yuan, Shen and Li 2011; Hiete et al. 2011). These approaches have become new trends for upgrading the effectiveness of reprocessing methods. Still, there is a potential to develop optimisation models for the recovery facilities.

Over the last five years, PEoL of building related approaches such as DfD principle (Papakyriakou & Hopkinson 2012; Thormark 2007), risk management (Noguchi, Park & Kitagaki 2015) and BIM have commonly discussed among the researchers and has an exponential growth. Hosseini et al. (2013b) and Hosseini et al. (2015a) discuss the integration of DfRL and HoI to provide a solid approach for PEoL of building operations. Risk management is still in the infancy stage and only common risks in the demolition and deconstruction stages have been identified. Noticeably, the concept of BIM has been gradually applied for facilitating deconstruction and material recovery during last three years (Akbarnezhad & Nadoushani 2014; Ness et al. 2015). SLR, however, reveals that the authors have focused on exploring the factors affecting the PEoL operations and investigating the barriers impeding the operations, compared to the discussions on strategic management approaches to overcome the challenges.

3.2 Relationships between the main operations in PEoL of building

Reverse Logistics and CLSC concepts support diverting extracted salvaged resources at the EoL of buildings from landfill and generate value-added resources for secondary markets (Yuan 2014; Nasir et al. 2016). The starting point of the PEoL of the building is demolition or deconstruction of a building. Research papers have discussed both conventional and selective demolition methods (Bhandari, Kulkarni & Malviya 2013; Akbarnezhad, Ong & Chandra 2014). However, the conventional demolition process does not support sustainable principles and has become one of the major barriers in RL (Chileshe et al. 2015). Selective demolition is a process which closely relates to the sustainable principles. The pre-planning is therefore essential for systematically demolish a building adhering to the sustainable principles. Still, the advantages of the conventional demolition such as, time and cost savings, and providing the land for new construction activities (Lu, Lau & Poon 2009; Rios, Chong & Grau 2015). Both methods have therefore subjected to comparisons regarding short-term and long-term benefits and drawbacks (Cha, Kim and Kim 2011; Coelho & de Brito 2011). Even though the selective demolition or deconstruction is effective compared to conventional method, it is not realistic in practical scenario compared to the hybrid method which is economically and environmentally effective (Pun, Liu & Langston 2006; Pun & Liu 2006). Aidonis et al. (2008) further deal with the optimisation of selective demolition process which results in minimum disposal. Deconstruction and selective demolition are further facilitated by, designing out waste or DfD principles (Thormark 2007). The DfD principles initiate at the design stage under the life cycle analysis of the materials or products and facilitate the RL and CLSC (Weil, Jeske & Schebek 2006). The DfD principles should be linked with the optimisation process of building dismantling.

The salvage resources at the deconstruction or demolition are subjected to collection, testing, sorting and recovery process. Transportation is the physical connector of the main stages.

Optimum transportation significantly affects the RL process to maintain the quality and meet the market demand of the recovered resources (Shakantu et al. 2008; Schultmann and Sunke 2007a; 2007b). However, there is a deficiency of studies related to the transportation optimisation and effective use of storage and other facilities about PEoL of building operations in the construction industry. Sorting is also supported by effective planning of resources and facilitates deconstruction process (Wang et al. 2010). The process classifies the salvage extracted at the EoL of building based on the characteristics of salvage to select a suitable reprocessing method. On-site sorting is known as an effective method compared to off-site and supports the effective RL and CLSC processors (Chileshe, Rameezdeen and Hosseini 2016; Brennan et al. 2014). The location optimisation and task allocation are still an understudied areas during PEoL of building operations (Anna & Joanna 2015). This need to be linked with the transportation patterns and distance for an effective recovery.

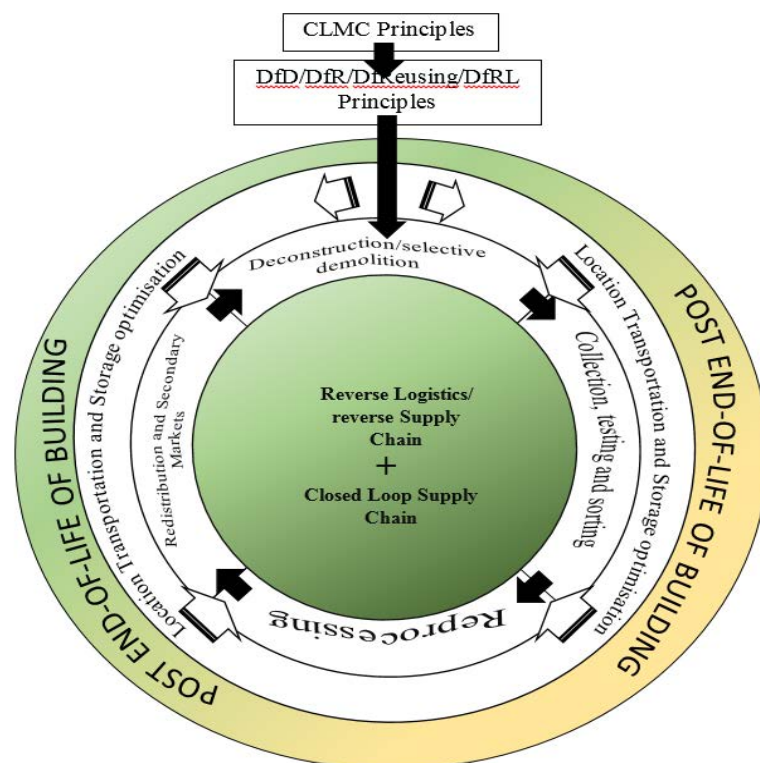

Figure 16: Interrelationship between main stages of PEoL of buildings

Reusing or recycling are one of the frequently used methods decided based on the quality and condition of salvage and at the end of sorting process (da Rocha & Sattler 2009). Reusing is an effective method compared to recycling regarding, time, cost and energy efficiency (Nordby et al. 2009; Sassi 2008). Particularly, deconstruction is the main facilitator to enhance the rate of reusability of the salvage (Lockrey et al. 2016; Laefer & Manke 2008). Recycling structural concrete elements have become a trend among the researchers. Recycled concrete aggregate, recycling glass, gypsum and composite materials have a considerable demand for civil engineering projects (Tam 2008; 2009; Tam and Tam 2006b; Tam, Tam and Le 2010; Conroy, Halliwell and Reynolds 2006; Singh & Singh 2016; Rodríguez-Quijano et al. 2015; Noguchi, Kitagaki & Tsujino 2011). The recycling is well established in Japan, the US and Hong Kong compared to Australian context regarding initial investment, advanced technologies, sorting mechanisms, public awareness and regulatory support (Jin & Chen 2015; Tam, Tam and Le 2010; Tam, Kotrayothar & Loo 2009). The successful implementation of the recycling and the

reusing processes are, therefore, directly affected by regional and social contexts. The effective utilisation of both reusing and recycling methods under the sustainable principles are essential (Meyer 2007; Patel et al. 2015). This is supported by the pre-planning process of deconstruction and recovery, where the designing-out concept can be adopted (Hiete et al. 2011). At the end of the reprocessing stage, disposal is the last option. The optimum and effective planning of PEOl of building operations mitigates the amount of disposal. DfD has become the leading point which has built-up a sound integration between all the stages of the RL process. Noticeably, Sassi (2008), investigates CLMC principles, which concerns long-term material recovery targeting infinite recycling. The author argues that DfD only supports the short-term material recovery. On top of the DfD, CLMC principles, therefore, need to be concerned to achieve the zero-waste concept (Mulder, Jong & Feenstra 2007). The interrelationship of all these aspects is illustrated in Figure 2, for an effective EoL of building salvage recovery based on RL and CLSC concepts.

3.3 Impediments in PEOl operations

The process explained in section 3.2, have found ineffective and impractical due to various impediments such as barriers, challenges and risks. The common barrier is unsupportive and conventional attitudes among the professionals and public, particularly the lack of government regulatory and legislative support (Couto and Couto 2007; Wang et al. 2010; Park and Tucker 2016). This results in financial risks and effects workplace health and safety criteria (Rameezdeen et al. 2015). It links with similar nature barriers such as poor managerial approach and lack of central coordination system, which affect the process of deconstruction and reprocessing (Chileshe et al. 2014; Saraiva, Borges & Filho 2012; Tam and Tam 2006a). Time and cost overruns and risks in investments have identified as the next most crucial barriers particularly in deconstruction, sorting and reprocessing (Saghafi and Teshnizi 2011; Zhao, Leeftink & Rotter 2010). Time and cost overruns are mainly due to the labour and transportation. This decline the salvage resource supply for the reprocessing stage and demand for recovered products at the end of the recovery process. The imbalance of demand and supply creates market uncertainty which interrelates with risks in investment particularly when investing in recycling centers (Nunes et al. 2007; Tam and Tam 2006a; Nunes, Mahler and Valle 2009) which need to be subjected to thorough investigation based on different contexts. The private sector is, therefore, reluctant to invest in recycling centers due to lack of economic feasibility (Zhao, Ren and Rotter (2011). However, there is a deficiency of studies on the quantitative analysis of the market uncertainty based on the demand and supply of the recovered products and salvage materials.

Health and safety risks are commonly found in the demolition or deconstruction process. According to Rameezdeen et al. (2015), such risks causes due to the contaminated and hazardous substances at the dismantling. Fauzey et al. (2015) and Bloomfield et al. (2015) identify risks related to hazardous equipment used, hazardous substances extracted in demolition, and falling objects to the surroundings, tipping over salvage or fixed items, deteriorated rafters and collisions with heavy plant. Lack of systematic separation can also cause risks through hazardous substances in disposal and reprocess (Altuncu and Kasapşekkin 2011; Arunvivek, Maheswaran & Kumar 2015). Injuries can cause mental and physical distractions and mainly affect the labour productivity. There is still room to analyse the health and safety and other types of risks about the dismantling and reprocessing stage.

Rameezdeen et al. (2015) and Chileshe et al. (2015) have identified interrelationships in between those barriers. Lack of government and organisational support influence most of the barriers such as cost, financial risks, health and safety issues and lack of recognition. It results in lower productivity levels, lower salvage quality, financial crisis and market uncertainty. Poor information flow, managerial issues, coordination and lack of interrelationships between the stakeholders have become the main reasons behind these barriers. It interconnects the barriers in different perspectives (da Rocha and Sattler 2009; Chileshe et al. 2015; Nunes, Mahler & Valle 2009). The corrective measures or remedial actions to overcome these barriers should facilitate developing a sound information flow under a strategic management approach.

3.4 Corrective measures and decision support approaches

Corrective measures or remedial actions include the steps undertaken or suggested by the articles to overcome the barriers and challenges discussed in section 3.3. Few articles have suggested remedial actions considering the different RL operations. Sound information flow has been suggested by the majority which supports the close collaboration of the stakeholders (Couto and Couto 2010; Warren, Chong and Kim 2008; Nunes, Mahler and Valle 2009). A centralised body, supported by the government and legal provisions is essential to integrate all the recovery related activities. It enables transparency and trust between the parties (Couto and Couto 2007; Pun et al. 2006; Tam and Tam 2006a; Zhao, Ren and Rotter 2011). Awareness and training programs among the practitioners are also essential to promoting the value of deconstruction and designing-out concepts (Gorgolewski 2006; Liu 2016). This includes the establishment of standards and guidelines for deconstruction, sorting and recycling and reusing activities and facilitate quality output. This secures the private sector large scale investments on recycling centers and other recovery activities. Financial incentives, optimised pricing strategies and economies of scale enable effective material and product recovery. “Mono landfill” concept also facilitates possible future recovery (Zhao, Ren & Rotter 2011). These common remedial actions can be slightly varied based on different contexts and the different stages in the recovery process of salvage resources. The application is however essential to overcome the barriers and identify and mitigate the risks and uncertainties.

Several studies have suggested decision support approaches to build-up interrelationships between the barriers, critical success factors and drivers separately related to RL concepts, deconstruction, reusing and recycling practices. It enables interrelationships among the identified criteria and facilitates decision-making process as a proactive strategy to overcome challenges described in section 3 (Rameezdeen et al. 2015; Chileshe et al. 2015; Chileshe, Rameezdeen & Hosseini 2016). The interrelationships of the findings generate a concise framework or model and act as a guideline for the decision-making process. Sensitivity analysis has been used in optimising the selective demolition or deconstruction strategies (Coelho and de Brito 2011; Cha, Kim & Kim 2011). Anumba, Abdullah and Ruikar (2008) have utilised the sensitivity analysis to support the expert decision making. These techniques have provided contemporary perspectives for strategic management approaches which can be implemented in an information-based environment in PEOl of building operations.

3.5 Information-based strategic management approaches

Studies have confirmed that information had become one of the main components, facilitating the implementation of strategic management approaches with a close collaboration of the

stakeholders. One such approach is the integration of information and DfD principles in one platform (Hosseini et al. 2015; Akinade et al. 2016). It particularly acts as a medium of transforming the information which is to be incorporated at the initial planning stage and foresees the operations, barriers and the remedial actions. SLR highlights the deconstruction recovery planning approach, based on the different recovery strategies under energy, time and resource trade-off, which further supports DfD (Schultmann & Sunke 2007a; Isiadinso et al. 2006). Pre-planning is also essential in sorting process, which includes space arrangement, salvage classification, etc. (Wang et al. 2010). Here the information on deconstruction planning approach can also be employed to identify potential recovery methods and to enhance the sustainable management. The above approaches directly facilitate the potential of reusability and recyclability under the reprocessing strategies supported by proper documentation. A mix of both quantitative and qualitative information are essential for the effective documentation Wu et al. (2016) highlights the value of proper quantitative documentation related to recycling process (Shakantu et al. 2008; Zhao, Ren and Rotter 2011; Wu et al. 2016). However, there is a deficiency of studies on the quantitative analysis of these main stages and their operations.

Risk management is also a proactive and strategic management approach. Risks related to the deconstruction and demolition process have been identified. However, risk management approach has not been suggested for the entire RL process, instead of risk assessment and evaluation model on recycling concrete (Noguchi, Park & Kitagaki 2015). Even though the risks is considered as one of the significant barriers (Section 3.3), deficiency of studies have found on risk identification, assessment and evaluation including risk response strategies during PEOl of buildings.

Life Cycle Assessment is again a supportive indicator for the decision making process in the planning stage. The environmental impact is assessed on each material and product in different stages of the construction life cycle. This can be combined with the CLMC principles. Based on the available information suitable dismantling and recovery options can be selected (Blengini 2009). This approach concern on energy saving, preserving natural resources and sustainability. Emergy analysis is another advanced version of strategic management approaches which analyses the efficiency of recycling process on measuring the direct and indirect energy consumption and transformation quantity (Yuan, Shen & Li 2011). Only one study has found in regarding the emergy analysis concept which facilitates the quantitative information requirement and still there is room for studies.

BIM is a novel approach in PEOl of building operations which have the potential of sound information management during the entire operation. It has rarely been applied in PEOl of building operations. BIM can, therefore, be used as the information repository and information management system during the PEOl of building operations. BIM has often been used for the deconstruction purposes, such as for analysis of deconstruction strategies and the measurement of deconstructability using a BIM-DAS score (Akinade et al. 2015; Cheng, Won & Das 2015). The concept of deconstruction planning approach (Schultmann & Sunke 2007a) can be employed under a BIM-based development supports the DfD. Ness et al. (2015) introduce novel combination between Radio Frequency Identification (RFID) and BIM to enhance the recovery capacity. BIM can, therefore, be implemented effectively when it is supported by any other approach. There is still room for the implementation of BIM at the dismantling, material or product recovery process, transportation and location optimisation aspects during PEOl of the building. Further, a strategic management approach considering the PEOl of building operations, however, have not been developed, with the collaboration of BIM.

4. CONCEPTUAL FRAMEWORK

The SLR has investigated the main themes related to PEOl of buildings and has carried out a discussion on the interrelationships of the PEOl operations, challenges, barriers and risks in the operational stages, corrective measure or remedial actions and strategic management approaches. The gist of the SLR findings results in conceptual framework, which has been developed to highlight the sustainable management within the PEOl of buildings. The framework demonstrated in Figure 3. It is the representation of the sustainable management process of the PEOl of building operations.

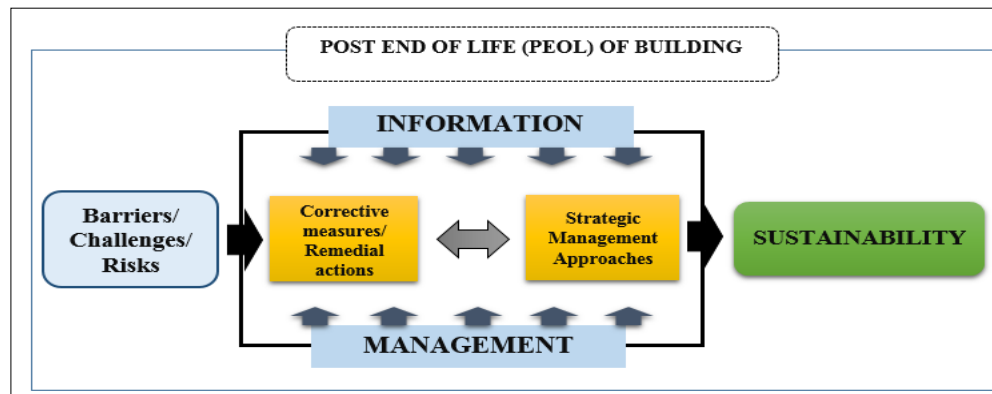

Figure 17: Conceptual framework

Post end-of-life of building operations are affected by the barriers, challenges and the risks as discussed in Section 3.3. The root causes of the impediments have found as lack of information and lack of close collaboration between stakeholders. A strong information base with a management perspective is essential to support the existing corrective measures and existing strategic management approaches to facilitate the sustainability of the PEOl of building operations (Akbarnezhada & Nadoushania 2014). This stimulates pre-planning of PEOl of building operations at the design, construction, maintenance stages of construction life cycle using the principles of CLMC and designing-out concepts, where the strong information base can be developed using different techniques (Example: BIM) (Volk, Stengel, & Schultmann 2014; Sassi 2008). The combined approach for the PEOl of building enhance the value of salvaged resources and then facilitate deconstruction, sorting and effective and efficient material reprocessing. The mechanism further upgrades the PEOl of building operations to regain the material and product value with minimum waste generation. A strong interrelationship of PEOl of building operations can then be accomplished under an economic, environmental and social viability to sustainable development.

5. RECOMMENDATIONS FOR FURTHER RESEARCH

In response to the identified gaps, the following research questions are beneficial for further investigations in PEOl of building operations.

- *Best practices to plan PEOl of building operations in design, construction and maintenance stages*

The knowledge created at the end of this process will result in the integration of CLMC principles with the designing-out concept (Sassi 2008). Particularly, this unfolds the perspectives of diverting the conventional practices of building life cycle to support the PEOl of building operations. It further includes the contribution of the stakeholders in each stage.

- *Development of optimisation models for the recovery facilities*

The SLR highlights the potential in identifying the optimisation levels during PEOl of building operations. It has become a new trend for upgrading the effectiveness of the entire process using quantitative information (Wu et al. 2016; Hiete et al. 2011). Following implications have suggested under a quantitative analysis to overcome the knowledge gaps.

- Transportation optimisation and location allocation strategies in between the sorting, recovery processors and storage facilities.
- An optimisation model for material and product recovery under a minimum waste generation. It should facilitate a trade-off between time, cost and the quality of salvage resources and recovered products.
- Quantitative analysis to optimise demand and supply of the recovered products and salvage materials.

- *Risk management approach for PEOl of building operations*

SLR unfold the barriers, challenges and risks related to the PEOl of building operations. Risks have therefore been identified as one of the major barriers or challenges. Risk management approach can facilitate the classification of risks related to each stage in PEOl of building operations, assessment and evaluation for decision making approaches. Risk management is a strategic management approach and it can be facilitated by information- based approach to enhance the productiveness of the investigation.

- *Information-based strategic management approaches*

Information is the crucial factor affecting the PEOl of building operations. BIM can be used to create a sound information repository and provide an effective implications. Following are the possible directions which the BIM-enabled approaches can be undertaken.

- BIM-enabled optimisation strategy for transportation, location and storage facilities in PEOl of building operations
- Environmental and economic assessment of recovery strategies based on BIM
- BIM-enabled risk management in PEOl of building operations.
- Integration of CLMC principle with BIM
- Stakeholder management of PEOl of building operations: BIM-enabled approach

6. CONCLUSIONS

A SLR explores the synergies between the concepts related to the PEOl of building using 83 articles over the period of the year 2006-2016. The selections are under the three main phases. Thematic analysis was conducted to analyse the selected articles under five main areas. Recently articles related to advanced, innovative and proactive approaches on PEOl of building operations have also significantly increased compared to first five years. The discussion was carried out on interrelationships of the PEOl operations, challenges, barriers and risks in the operational stages, corrective measure or remedial actions and particularly the advanced strategic management approaches. CLMC principles with the designing-out concept and optimisation strategies have supported to develop relationships during the entire RL and CLSC (Rios, Chong and Grau 2015). Barriers, challenges and risks have however controlled the successful implementation. Therefore, the paper suggested a solid approach for sustainable management of the PEOl of the building. The combination of the information and management perspectives supports the existing corrective measures and the existing strategic management approaches for handling the impediments in PEOl of building operations. The process should be initiated at the design stage, which foresees the construction and maintenance stages of

building life cycle. To implement these concepts in the real life setting, the paper highlights significant implications under the future research agenda based on several key areas. Therefore, the future research directions support the different perspectives of upgrading the PEOl of building concepts under a sound information flow with management principles. Particularly, BIM has been suggested as an information-based approach to be used as a facilitator for implementing the strategic management approaches for the PEOl of buildings (Volk, Stengel & Schultmann 2014). The findings of the SLR sets productive grounds for sustainable management of PEOl of building operations while upgrading the RL and CLSC operations.

7. REFERENCES

- Agrawal, S., Singh, R.K., and Murtaza, Q., 2015, A literature review and perspectives in reverse logistics, *Resources, Conservation and Recycling*, 97, pp. 76-92.
- Aidonis, D., Xanthopoulos, A., Vlachos, D., and Iakovou, E., 2008, An analytical methodological framework for managing reverse supply chains in the construction industry, *WSEAS Transactions on Environment and Development*, vol. 4, no. 11, pp. 1036-1046.
- Akbarnezhad, A., and Nadoushani, Z.M., 2014, Estimating the Costs, Energy Use and Carbon Emissions of Concrete Recycling Using Building Information Modelling, *ISARC. Proceedings of the International Symposium on Automation and Robotics in Construction*.
- Akbarnezhad, A., Ong, K.C.G., and Chandra, L.R., 2014, Economic and environmental assessment of deconstruction strategies using building information modeling, *Automation in Construction*, 37, pp. 131-144.
- Akinade, O.O., Oyedele, L.O., Bilal, M., Ajayi, S.O., Owolabi, H.A., Alaka, H.A. and Bello, S.A., 2015, Waste minimisation through deconstruction: A BIM based Deconstructability Assessment Score (BIM-DAS), *Resources, Conservation and Recycling*, 105, pp. 167-176.
- Akinade, O.O., Oyedele, L.O., Ajayi, S.O., Bilal, M., Alaka, H.A., Owolabi, H.A., Bello, S.A., Jaiyeoba, B.E. and Kadiri, K.O., 2016, Design for Deconstruction (DfD): Critical success factors for diverting end-of-life waste from landfills, *Waste management*.
- Albaloushi, H. and Skitmore, M., 2008, Supply chain management in the UAE construction industry, *International Journal of Construction Management*, 8(1), pp. 53-71.
- Altuncu, D., and Kasapşekin, M.A., 2011, 'Management and recycling of constructional solid waste in Turkey', *Procedia Engineering*, vol. 21, pp. 1072-1077.
- Andersen, M.S., 2007, An introductory note on the environmental economics of the circular economy, *Sustainability Science*, 2(1), pp. 133-140.
- Anumba, C., Abdullah, A. and Ruikar, K., 2008, An Integrated System for Demolition Techniques Selection, *Architectural Engineering and Design Management*, 4(2), pp. 130-148.
- Arunvivek, G., Maheswaran, G. and Kumar, S.S., 2015, Eco-friendly Solution to Mitigate the Toxic Effects of Hazardous Construction Industry Waste by Reusing in Concrete for Pollution Control, *Nature Environment and Pollution Technology*, 14(4), pp. 963-966.
- Bevan, E.A.M., and Yung, P., 2015, Implementation of corporate social responsibility in Australian construction SMEs, *Engineering, Construction and Architectural Management*, 22(3), pp. 295-311
- Bhandari, M., Kulkarni, V. and Malviya, R., 2013, Building Demolition: Ground to Earth Important as Construction, *International Journal of Emerging Technology and Advanced Engineering*, pp. 396-401.
- Blengini, G.A., 2009, Lifecycle of buildings, demolition and recycling potential: a case study in Turin, Italy, *Building and Environment*, 44(2), pp. 319-330.
- Bloomfield, B., Hosseini, M.R., Rameezdeen, R. and Chileshe, N., 2015, An investigation into health and safety risks associated with deconstruction, *RICS COBRA AUBEA 2015: Proceedings of the 2015 Annual RICS International Research Conference*.
- Brennan, J., Ding, G., Wonschik, C.R., and Vessalas, K., 2014, A closed-loop system of Construction and Demolition Waste Recycling, *ISARC. Proceedings of the International Symposium on Automation and Robotics in Construction*.
- Cha, H.S., Kim, K.H. and Kim, C.K., 2011, Case study on selective demolition method for refurbishing deteriorated residential apartments, *Journal of construction engineering and management*, 138(2), pp. 294-303.
- Cheng, J., Won, J. and Das, M. 2015, Construction and demolition waste management using BIM technology, *International Group for Lean Construction Conference (IGLC), Perth, Australia*.

- Chileshe, N., Rameezdeen, R., Lehmann, S., Hosseini, M., Raiden, A. and Aboagye-Nimo, E., 2014, Reverse Logistics (RL) implementation among contractors in Australia: Practices and barriers, Association of Researchers for Construction Man.
- Chileshe, N., Rameezdeen, R., Hosseini, M.R. and Lehmann, S., 2015, Barriers to implementing reverse logistics in South Australian construction organisations, *Supply Chain Management: An International Journal*, 20(2), pp. 179-204.
- Chileshe, N., Rameezdeen, R. and Hosseini, M.R., 2016, Drivers for adopting reverse logistics in the construction industry: a qualitative study', *Engineering Construction and Architectural Management*, 23(2), 2016, pp. 134-157.
- Chileshe, N., Rameezdeen, R., Hosseini, M.R., Lehmann, S. and Udejaja, C., 2016, Analysis of reverse logistics implementation practices by South Australian construction organisations, *International Journal of Operations & Production Management*, 36(3), pp. 332-356.
- Chinda, T. and Ammarapala, V., 2016, Decision-making on reverse logistics in the construction industry, *Songklanakarinn Journal of Science & Technology*, 38(1) pp. 7-14.
- Coelho, A. and de Brito, J., 2011, Economic analysis of conventional versus selective demolition—A case study, *Resources, Conservation and Recycling*, 55(3), pp. 382-392.
- Conroy, A., Halliwell, S. and Reynolds, T., 2006, Composite recycling in the construction industry, *Composites Part A: Applied Science and Manufacturing*, 37(8), pp. 1216-1222.
- Couto, A.B., and Couto, J.P., 2007, Why deconstruction is not adequately considered in Portuguese building refurbishment.
- Couto, J. and Couto, A., 2010, Analysis of barriers and the potential for exploration of deconstruction techniques in Portuguese construction sites, *Sustainability*, 2(2), pp. 428-442.
- da Rocha, C.G. and Sattler, M.A., 2009, A discussion on the reuse of building components in Brazil: An analysis of major social, economical and legal factors, *Resources, Conservation and Recycling*, 54(2), pp. 104-112.
- Fauzey, I.H.M., Nateghi, F., Mohammadi, F. and Ismail, F., 2015, Emergent Occupational Safety & Health and Environmental Issues of Demolition Work: Towards Public Environment, *Procedia-Social and Behavioral Sciences*, 168, pp. 41-51.
- Fereday, J. and Muir-Cochrane, E., 2006, Demonstrating rigor using thematic analysis: A hybrid approach of inductive and deductive coding and theme development, *International journal of qualitative methods*, 5(1), pp. 80-92.
- Fink, A., 2013, *Conducting research literature reviews: from the Internet to paper*, Sage Publications,
- Gorgolewski, M., 2006, The implications of reuse and recycling for the design of steel buildings, *Canadian Journal of Civil Engineering*, 33(4), pp. 489-496.
- Govindan, K., Soleimani, H. and Kannan, D., 2015, Reverse logistics and closed-loop supply chain: A comprehensive review to explore the future, *European Journal of Operational Research*, 240(3), pp. 603-626.
- Hiete, M., Stengel, J., Ludwig, J. and Schultmann, F., 2011, Matching construction and demolition waste supply to recycling demand: a regional management chain model, *Building Research & Information*, 39(4), pp. 333-351.
- Hosseini, M., Chileshe, N., Rameezdeen, R. and Lehmann, S., 2013a, Sensitizing the Concept of Reverse Logistics (RL) for Construction Context, Islamic Azad University.
- Hosseini, M.R., Chileshe, N., Rameezdeen, R. and Lehmann, S., 2013b, The crucial role of design for reverse logistics (DfRL) and harvesting of information (HoI) in reverse logistics systems, Association of Engineering, Project, and Production Management.
- Hosseini, M.R., Chileshe, N., Rameezdeen, R. and Lehmann, S., 2014, Reverse logistics for the construction industry: Lessons from the manufacturing context, *International Journal of Construction Engineering and Management*, 3(3), pp. 75-90.
- Hosseini, M.R., Chileshe, N., Rameezdeen, R. and Lehmann, S., 2015a, Integration of design for reverse logistics and harvesting of information: a research agenda, *International Journal of Logistics Systems and Management*, 20(4), pp. 480-515.
- Hosseini, M.R., Rameezdeen, R., Chileshe, N. and Lehmann, S., 2015b, Reverse logistics in the construction industry, *Waste Management & Research*, 33(6), pp. 499-514.
- Ignatius, O. and Opeyemi, O.J., 2014, Recycling of some selected building materials in the construction industry: Prospect and challenges.
- Isiadinso, C., Anumba, C., El-Rimawi, J. and Bhamra, T., 2006, Design for deconstruction lessons from the manufacturing industr'.
- Jin, R. and Chen, Q., 2015, Investigation of concrete recycling in the US construction industry, *Procedia Engineering*, 18, pp. 894-901.
- Laefer, D.F. and Manke, J.P., 2008, Building reuse assessment for sustainable urban reconstruction, *Journal of construction engineering and management*, 134(3), pp. 217-227.

- Liu, J., 2016, Design for Deconstruction with Demountable Composite Beams and Floor Systems, *American Institute of Steel Construction*.
- Lockrey, S., Nguyen, H., Crossin, E. and Verghese, K., 2016, Recycling the construction and demolition waste in Vietnam: opportunities and challenges in practice', *Journal of Cleaner Production*, 133, pp 757-766.
- Lu, M., Lau, S.C. and Poon, C.S., 2009. Simulation approach to evaluating cost efficiency of selective demolition practices: case of Hong Kong's Kai Tak Airport demolition, *Journal of Construction Engineering and Management*, 135(6), pp. 448-457.
- Meyer, C., 2007, The economics of recycling in the US construction industry', *Economics*, 101(7).
- Mulder, E., de Jong, T.P.R. and Feenstra, L., 2007. Closed Cycle Construction: An integrated process for the separation and reuse of C&D waste. *Waste Management*, 27(10), pp. 408-415.
- Nasir, M.H.A., Genovese, A., Acquaye, A.A., Koh, S. and Yamoah, F., 2016, Comparing linear and circular supply chains: A case study from the construction industry, *International Journal of Production Economics*.
- Ness, D., Swift, J., Ranasinghe, D.C., Xing, K. and Soebarto, V., 2015, Smart steel: new paradigms for the reuse of steel enabled by digital tracking and modelling, *Journal of Cleaner Production*, 98, pp. 292-303.
- Noguchi, T., Kitagaki, R. and Tsujino, M., 2011, Minimizing environmental impact and maximizing performance in concrete recycling, *Structural Concrete*, 12(1), pp. 36-46.
- Noguchi, T., Park, W-J. and Kitagaki, R., 2015, Risk evaluation for recycled aggregate according to deleterious impurity content considering deconstruction scenarios and production methods, *Resources, Conservation and Recycling*, 104, pp. 405-416.
- Nordby, A.S., Berge, B., Hakonsen, F. and Hestnes, A.G., 2009, Criteria for salvageability: the reuse of bricks, *Building Research & Information*, 37(1), pp. 55-67.
- Nunes, K., Mahler, C., Valle, R. and Neves, C., 2007, Evaluation of investments in recycling centres for construction and demolition wastes in Brazilian municipalities, *Waste management*, 27(11), pp. 1531-1540.
- Nunes, K.R.A., Mahler, C.F. and Valle, R.A.. 2009, Reverse logistics in the Brazilian construction industry, *Journal of Environmental Management*, 90(12), pp. 3717-3720.
- Papakyriakou, A., and Hopkinson, L., 2012, The potential of integrating Design for Deconstruction as a waste minimization strategy into the profession of the architect.
- Park, J. and Tucker, R., 2016, Overcoming barriers to the reuse of construction waste material in Australia: a review of the literature, *International Journal of Construction Management*, pp. 1-10.
- Patel, S., Pansuria, A., Shah, V. and Patel, S., 2015, Construction and Demolition Waste Recycling, *International Journal for Innovative Research in Science and Technology*, 1(7), pp. 266-286.
- Pokharel, S. and Mutha, A., 2009, Perspectives in reverse logistics: a review, *Resources, Conservation and Recycling*, 53(4), pp. 175-182.
- Pun, S.K. and Liu, C., 2006, A framework for material management in the building demolition industry, *Architectural Science Review*, 49(4), pp. 391-398.
- Pun, S.K., Liu, C. and Langston, C., 2006, Case study of demolition costs of residential buildings, *Construction Management and Economics*, 24(9), pp. 967-976.
- Pun, S.K., Liu, C., Langston, C., Treloar, G. and Itoh, Y., 2006, Promoting the reuse and recycling of building demolition materials, *World Transactions on Engineering and Technology Education*, 5(1), p. 195-200.
- Rajendran, P. and Gomez, C.P., 2012, Implementing BIM for waste minimisation in the construction industry: a literature review, *2nd International Conference on Management, Malaysia*.
- Rameezdeen, R., Chileshe, N., Hosseini, M.R. and Lehmann, S., 2015, A qualitative examination of major barriers in implementation of reverse logistics within the South Australian construction sector, *International Journal of Construction Management*, pp. 1-12.
- Rios, F.C., Chong, W.K. and Grau, D., 2015, Design for Disassembly and Deconstruction-Challenges and Opportunities, *Procedia Engineering*, 118, pp. 1296-1304.
- Rodríguez-Quijano, M., Jiménez-Rivero, A., de Guzmán-Báez, A. and García-Navarro, J., 2015, Gypsum plasterboard deconstruction to recycling economic study in europe.
- Rogers, D.S. and Tibben-Lembke, R.S., 1999, *Going backwards: reverse logistics trends and practices*, Reverse Logistics Executive Council Pittsburgh, PA.
- Saghafi, M.D., and Teshnizi, Z.A.H., 2011, Building deconstruction and material recovery in Iran: an analysis of major determinants, *Procedia Engineering*, 21, pp. 853-863.
- Saraiva, T.S., Borges, M.M. and Filho, A.C., 2012, The importance of recycling of construction and demolition waste, *Proceeding: 28th conference, opportunities, limits & needs towards an environmentally responsible architecture Lima*.
- Sassi, P., 2008, Defining closed-loop material cycle construction, *Building Research & Information*, 36(5), pp. 509-519.
- Schamne, A.N., and Nagalli, A., 2016, Reverse Logistics in the Construction Sector: A Literature Review.
- Schultmann, F., and Sunke, N., 2007a, Energy-oriented deconstruction and recovery planning, *Building Research & Information*, 35(6), pp. 602-615.

- Schultmann, F. and Sunke, N., 2007b, *Organisation of reverse logistics tasks in the construction industry*, Shakantu, W., Tookey, J., Muya, M. and Bowen, P., 2007, Beyond Egan" s supply chain management: advancing the role of logistics in the South African construction industry, *Acta Structilia*, 14(1), pp. 93-115.
- Shakantu, W., Muya, M., Tookey, J. and Bowen, P., 2008, Flow modelling of construction site materials and waste logistics: A case study from Cape Town, South Africa, *Engineering, Construction and Architectural Management*, 15(5), pp. 423-439.
- Singh, J. and Singh, R., 2016, A review on recycling of waste glass in construction industry.
- Sobotka, A. and Czaja, J., 2015, Analysis of the Factors Stimulating and Conditioning Application of Reverse Logistics in Construction, *Procedia Engineering*, 122, pp. 11-18.
- Stone, H., Sidel, J., Oliver, S., Woolsey, A. and Singleton, R.C., 2008, Sensory evaluation by quantitative descriptive analysis, *Descriptive Sensory Analysis in Practice*, pp. 23-34.
- Tam, V.W. and Tam, C., 2006a, Evaluations of existing waste recycling methods: a Hong Kong study, *Building and Environment*, 41(12), pp. 1649-1660.
- Tam, V.W. and Tam, C., 2006b, A review on the viable technology for construction waste recycling, *Resources, Conservation and Recycling*, 47(3), pp. 209-221.
- Tam, V.W., 2008, Economic comparison of concrete recycling: A case study approach, *Resources, Conservation and Recycling*, 52(5), pp. 821-828.
- Tam, V.W., 2009, Comparing the implementation of concrete recycling in the Australian and Japanese construction industries, *Journal of Cleaner Production*, 17(7), pp. 688-702.
- Tam, V.W., Kotrayothar, D. and Loo, Y-C., 2009, On the prevailing construction waste recycling practices: a South East Queensland study, *Waste Management & Research*, 27(2), pp. 167-174.
- Tam, V.W., Tam, L. and Le, K.N., 2010, Cross-cultural comparison of concrete recycling decision-making and implementation in construction industry, *Waste management*, 30(2), pp. 291-297.
- Thormark, C., 2007, Motives for design for disassembly in building construction, *International congress sustainable construction, materials and practices challenge of the industry for the new millennium, Lisbon*.
- Volk, R., Stengel, J. and Schultmann, F., 2014, Building Information Modeling (BIM) for existing buildings—Literature review and future needs, *Automation in Construction*, 38, pp. 109-127.
- Wang, J., Yuan, H., Kang, X. and Lu, W., 2010, Critical success factors for on-site sorting of construction waste: a China study, *Resources, Conservation and Recycling*, 54(11), pp. 931-936.
- Warren, J., Chong, W. and Kim, C., 2008, Recycling construction and demolition waste for construction in Kansas City metropolitan area, Kansas and Missouri, *Transportation Research Record: Journal of the Transportation Research Board*.
- Webster, J. and Watson, R.T., 2002, *Analyzing the past to prepare for the future: Writing a literature review*, JSTOR, pp. xiii-xxiii.
- Weil, M., Jeske, U. and Schebek, L., 2006, Closed-loop recycling of construction and demolition waste in Germany in view of stricter environmental threshold values, *Waste Management & Research*, 24(3), pp. 197-206.
- Wu, H., Duan, H., Zheng, L., Wang, J., Niu, Y. and Zhang, G., 2016, Demolition waste generation and recycling potentials in a rapidly developing flagship megacity of South China: Prospective scenarios and implications, *Construction and Building Materials*, 113, pp. 1007-1016.
- Yuan, F., Shen, L-y. & Li, Q-m., 2011, Emergy analysis of the recycling options for construction and demolition waste, *Waste management*, 31(12), pp. 2503-2511.
- Yuan, X-Y., 2014, Reverse Logistics in Chongqing Construction Industry, *Proceedings of the 2014 International Conference on Management Science and Management Innovation*, 2014, pp. 554-557.
- Zhao, W., Leefink, R. and Rotter, V., 2010, Evaluation of the economic feasibility for the recycling of construction and demolition waste in China—The case of Chongqing, *Resources, Conservation and Recycling*, 54(6), pp. 377-389.
- Zhao, W., Ren, H. and Rotter, V., 2011, A system dynamics model for evaluating the alternative of type in construction and demolition waste recycling center—The case of Chongqing, China, *Resources, Conservation and Recycling*, 55(11), pp. 933-944.

A GROUNDED THEORY APPROACH TO MENTORSHIP

E. A. Lester

CEOE Department, Stevens Institute of Technology, Hoboken, NJ, 07030 USA

Email: elester@stevens.edu

Abstract: Knowledge transfer from those with expertise to those who seek it remains “a black box” within the literature. Deconstruction and analysis of the activities that surround and contribute to knowledge transfer during mentoring was conducted during this pilot study. Weekly mentoring sessions were videotaped with full audio. Content neutral analysis documented body language and other features of participant interaction. Iterative coding of data using a grounded theory approach drove interpretation and theory building, maximizing sensitivity to context. The interpretive skills of the analyst coding the data, combined with unflinching candor regarding the constructive nature of these interactions, established the full complexity of the interactive context. While overt language was clearly intended to transfer subject matter expertise, simultaneous non-verbal processes defined or reinforced personal or organizational identity and other facets of the construction of the relationship between mentor and mentee. Increased understanding of this process is critical to organizational continuity of knowledge, and ultimately, to competitive advantage in business. This may lead to higher levels of knowledge transfer during mentoring programs, mitigating knowledge loss due to retirement, defection, and other events.

Keywords: Case Study, Grounded Theory, Knowledge Transfer, Mentorship, Non-Verbal Communication

1. INTRODUCTION

In an article recently published by the Institute of Electrical and Electronics Engineers (IEEE), “Pulse of Engineering: Where are the new Engineers?,” concerns about the aging workforce, the continued movement of engineers from firm to firm, and the lack of knowledge management [KM] systems were expressed. “Respondents are not particularly satisfied with their employers’ KM programs; on a scale of 1 to 10, where 10 was highest satisfaction, the average response was a 5.6 – average. Digging in a little deeper, some reasons for this dissatisfaction come to light. This year’s respondents indicated that less than half of the companies represented have methods to share knowledge, whether by mentoring, training, or other tools for knowledge capture,” (Ordman, 2017).

However, Harvard Business School professor Dorothy Leonard warns of the limits of, “...trying to transfer knowledge and codify fashion and expect people to actually use sophisticated behaviors... That’s what drives the need for coaches” (Silverthorne, 2002).

Dorothy Leonard’s *Critical knowledge transfer: Tools for managing your company's deep smarts* provides expression of the core motivations for this research:

When highly skilled subject matter experts, engineers, and managers leave their organizations, they take with them years of hard-earned, experience-based knowledge—much of it undocumented and irreplaceable. Organizations can thereby lose a good part of their competitive advantage. The tsunami of “boomer” retirements has created the most visible, urgent need to transfer such knowledge to the next generation. But there is also an ongoing torrent of

acquisitions, layoffs, and successions—not to mention commonplace promotions and transfers—all of which involve the loss of essential expertise.
(Leonard, et al, 2015)

This pilot study attempts to address mentorship, absent preconceptions, to determine what really happens during mentoring in order to build a foundation for future advances.

1.1 Literature review

A search of the mentorship, knowledge management/transfer (KM/KT), and built environment domains was conducted via keyword(s) in all available databases. The focus was mentorship and the built environment, or on KM/KT when overlapping those domains. The set of actual overlaps was quite small, and the articles later determined to fall only in the KM/KT domain are indicated in Figure 1, but will not be addressed, with three exceptions. These three foundational texts (Boisot, 1995; Boisot, 1998; Nonaka & Takeuchi, 1995), provide a grounding in KM/KT. Although Charles Egbu's extensive contribution to this domain is indisputable, his papers were underrepresented in the keyword search results; see (Hari, et al, 2005) for just one example.

[Numbers in Figure 1 denote citations (Section 4) and are appended, within brackets, to each citation.]

One article, (Bell, et al, 2016), fell at the intersection of all three domains, which suggested its importance. Unfortunately, that supposition reveals the limitations of keyword searches, since the recommendation it offered for promoting knowledge sharing is not novel: "...knowledge should be transferred to people rather than directly to a database," and its operative recommendations are much more difficult to execute than suggested.

Pathirage's dissertation (2007) and article (Pathirage, et al, 2006) fall in the overlap between KM/KT and the Built Environment, but are most compelling for their methodology and emphasis on tacit knowledge transfer and Communities of Practice (CoP). Unfortunately, due to lack of space, CoP will not be addressed in this paper. In contrast, Swap, et al's *Using mentoring and storytelling to transfer knowledge in the workplace* (2001) bridged KM/KT and Mentorship, and, although it did not focus on the built environment, did address tactics to make KT more successful. Memory, learning, heuristics, and social learning were key components.

The set of articles overlapping Mentorship and the Built Environment were somewhat diverse, revealing lack of cohesion in this domain. They ranged from the theoretical (Costa, et al, 2016), to the applied (Dougherty & Parfitt, 2013). One categorized mentor characteristics, observing, "...the relationship between a mentor and his/her protégé in the construction industry may be different from the mentoring relationships typically observed in other industries, due to [the] constantly changing work environment and crews, diverse and rapid tasks, and the short-term relationships that protégés have with their mentors," (Hoffmeister, et al, 2011).

Another attempted to improve safety communication on jobsites (Kaskutas, et al, 2013) through training and mentorship, which had ancillary benefits such as increasing levels of vigilance as foremen monitor their worksites for safety issues and violations.

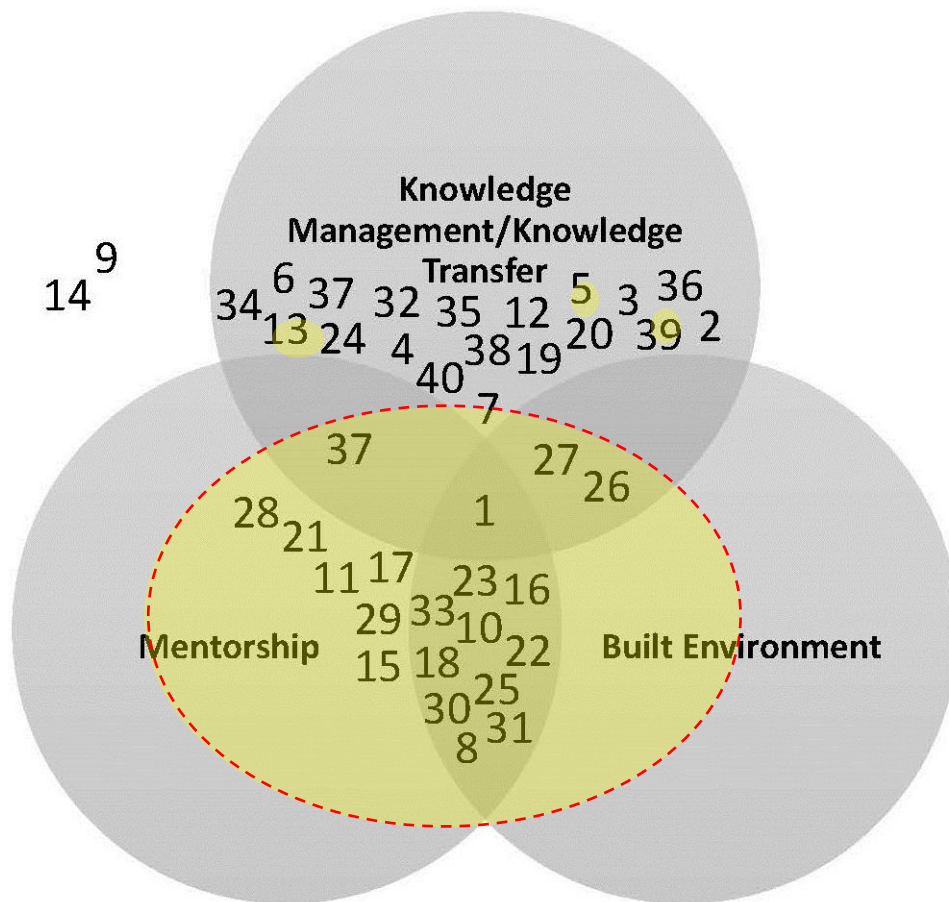

Figure 1: Articles categorized by domain (Lester, 2017).

Many of the articles emphasized experiential learning (Nicholas & Anandan, 2017) in academia-related contexts (Dougherty & Parfitt, 2013; Nicholas & Anandan, 2017; Palmer, et al, 2016; Ralph & Walker, 2014; Shaurette & Scott, 2012). Ten weaknesses of mentorship programs were identified (Ralph & Walker, 2014):

1. Program settings that are disorganized, poorly structured, or ill-managed
2. Interpersonal conflicts being handled poorly by participants
3. Mentor power differential fallout
4. Mentors forced into the mentorship role, being ill prepared, or being under-resourced
5. Procedures for assigning mentors to mentees being poor
6. Lack of incentives or benefits for mentors
7. Mentee participation being hindered by witnessing or participating in the above
8. Rigidity of mentoring or leadership style; attempts to adapt by mentors poorly aligned with mentees
9. Insufficient accommodation to cultural idiosyncrasies or inter-cultural norms, when applicable
10. Lack of a guiding mentorship model or conceptual framework

Others that were industry-centric (Reidy, 2009) or academia focused (Shaurette & Scott, 2012) were of limited value, primarily due to fit, not quality. Some false positives also occurred [9, 14].

The mentorship domain included one survey (Hunt & Michael, 1983), one longitudinal study (Payne & Huffman, 2005), and one meta-analysis (Eby, et al, 2008). Although their citations have not yet been fully mined, consideration of effect size in different contexts may prove invaluable. Other studies addressed perception of mentorship process quality (Hernandez, et al, 2016), collaboration beyond studio contexts' sustaining effects (Liem, 2009), and results that countervail social exchange theory being foundational (Raabe & Beehr, 2003).

1.2 Study context

The raw data consisted of more than nine hours of meetings between a 51-year-old male with twenty years of experience in the Built Environment (the mentor) and a 22-year-old male Masters student with almost no professional experience (the mentee). Eight mentoring sessions were held during an eight-week period. The mentee was a student in one of the mentor's courses the previous semester, but prior to this study, only one short one-on-one conversation regarding the mentee's undergraduate thesis had taken place.

1.3 Methodology

A grounded theory approach was employed. The research question was, “*What is really happening during mentoring?*” Direct mentor-mentee interactions were the focus of data collection, coding/analysis, theory development and associated iterative processes, as indicated in *Figure 2*. The video and audio recordings made were the only artifacts subjected to *ex post facto* analysis. Analysis and coding were independently conducted by research assistants (in an attempt to mitigate bias), and was visual, with no attempt to address tone of voice (Mehrabian, 1981). No interviews or debriefing sessions were conducted.

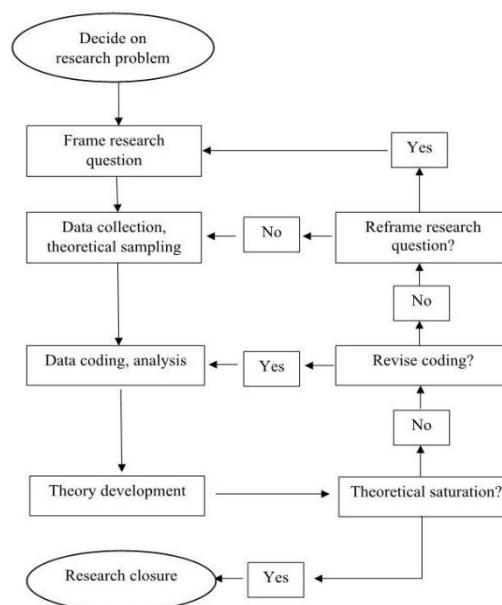

Figure 2: Grounded Theory Flow Chart (Bitsch, 2005)

During eight sessions, the participants were (with their consent) video and audio recorded. The author had no interaction with the participants before, during, or after sessions, and did not direct or structure the interactions. All activities were participant directed or negotiated.

Some sessions were didactic, with one of the participants consensually serving as “teacher” and the other as “student.” Other sessions were more free form; some were purely dialogic. Others focused on pre-prepared material displayed on a shared computer screen. There was a collaborative session at a whiteboard, and another that involved the review and markup of architectural and engineering drawings. The participants alone determined the nature of these interactions, usually negotiating the basis for the next session at the very end of the preceding one. The mentor-mentee relationship was constructed in real time during these sessions and no attempt was made to influence this process. No extra-session communication, other than brief exchanges between the participants for coordination purposes, occurred.

2. THE SESSIONS

2.1 Session 1 (1h 18m 55s)

Prior to this session, the mentee studied and prepared a synopsis of a book at the request of the mentor. During the session, the mentee referred to his notes and discussed the main points of the text, acting as “teacher” to the mentor’s “student.” Analysis of the video was broken into fifteen second intervals, each represented by a single bar in Figure 3 below.

The participants spoke during the entire session without significant pauses. Of the 316 fifteen second intervals, the mentee ‘had the floor’ 78.2% of the time and the mentor 21.8%. The mentor interrupted or interjected twenty times, while the mentee interrupted or interjected ten times. These are represented as red bars of varying widths. Sometimes these interruptions are clustered, indicating lively discussion, but for the most part they involve the mentor offering brief comments or clarifications to the mentee. This can be interpreted as both knowledge transfer and as a form of social construction of his role as mentor.



Figure 3: Turn taking in Session 1



Figure 4: Head nodding in Session 1

Figure 4 visualizes the phenomenon of head nodding via a paired frequency histogram. Mentor frequency per interval is indicated by a bar of 0, 1, or 2 units of length, while mentee frequency per interval is likewise indicated, although it is placed below the bar to facilitate comparison (both vertical directions are positive). The axis represents time.

Head nodding was observed in 149 of the 316 fifteen second intervals, or 47% of the time. The mentor/mentee split was 86.9% to 13.1% in the intervals where it was observed. Overlap occurred during only four of these intervals, which may indicate that nodding is self-cancelling, perhaps even subconsciously. A form of positive feedback, nodding both acknowledges the

other and encourages additional interjections or interruptions. The mentee's head nodding responded to either the mentor's turn or his interjections or interruptions. The mentor's head nodding was similar, but varied in frequency, decreasing over time. The mentor's sample standard deviation was 0.629, while the mentee's was 0.617, even though the delta in frequency was so large.

Nodding is also a form of mirroring. Mirroring naturally occurs during interpersonal interaction (Chartrand & Bargh, 1999) and may be one of the first forms of learned behaviour in human beings. This unconscious process takes many forms. While nodding is primarily sequential in nature, simultaneous, overlapping, or delayed forms of mirroring are also observed. Mirroring behaviour is not always evident, as in the case of smiling not being reciprocated (Figure 5). No reason for this lack of reciprocity was evident. Notional explanations include the mentor being otherwise engaged/focused in the task of teaching to the exclusion of attending to mentee non-verbal behaviours or cross-cultural disconnects regarding particular behaviours.

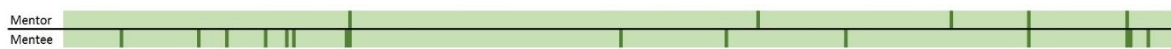

Figure 5: Smiling in Session 1

2.2 Session 2 (53m 26s)

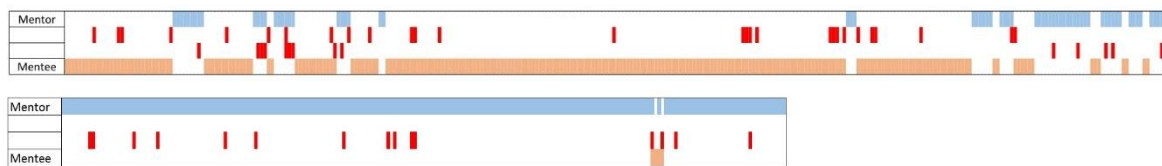

Figure 6: Turn taking in Session 2 (Session 1 above, for reference)



Figure 7: Nodding in Session 2

During this session, the mentor presented a case study and referred to a PowerPoint presentation on a wall monitor while advancing slides using the keyboard of his laptop, which also displayed the slides on its screen.

Session 2 was a much more one-sided affair, with the mentee nodding along while occasionally offering short comments. Only once did this erupt into a discussion, as indicated by the short burnt umber bar and the mentor's frequent head nodding during that timeframe (see Figures 6 & 7). Even during this short exchange, during which the mentee took the floor, mentee interruptions to mentor retorts were observed, indicating a spirited exchange. This may represent a form of social construction on the part of the mentee, establishing himself as an active agent instead of just a passive and compliant recipient of the information being offered. At an earlier juncture, the mentor nodded his head, an indication that the flow of the presentation was breached momentarily by one of the mentee's comments.

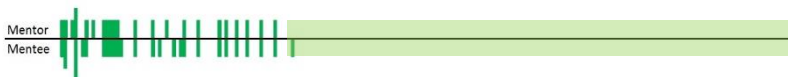

Figure 8: Monitor Views in Session 2

The participants viewed an external monitor displaying the mentor’s presentation with the frequency indicated in Figure 8. The participants consensually abandoned viewing the monitor—which was too far away for viewing details—and agreed to share the laptop screen, which they did for the remainder of the session (as indicated by the light green bar.) This required them to sit in close proximity. It is possible that sitting that close to one another out of necessity might psychologically hasten the relational status that would normally precipitate ‘intimate’ social distance (Hall, 1966). Other cues were present, but did not rise to the level of a distinguishable pattern.

2.3 Session 3 (51m 32s)

In this session, the mentee once again acted as “teacher,” presenting the remainder of the book synopsis previously prepared. The mentee referred to his notes while talking.

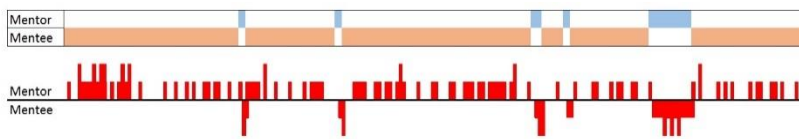

Figure 9: Turn taking and Nodding in Session 3



Figure 10: Mentor Fidgeting in Session 3

Nine different fidgeting behaviors were timecoded. In Figure 10, these color coded instances were collapsed into a simple stacked histogram and align with Figure 9’s axes (time) above. As can be seen, no significant clustering by type or frequency is seen. Fidgeting was absent for the first 7:45, was most intense in the initial minutes, then fell off over the course of the session. Perhaps this behavior reflects some mentor dissatisfaction with his role or the relevance of the content being imparted. Even fidgeting can be interpreted as a form of social construction, since a large proportion of non-verbal communication never reaches consciousness or approaches intentionality (Mehrabian, 1981).

2.4 Session 4 (1h 31m 52s)

The mentor took the lead in this discussion, which focused on a set of construction drawings. Both were seated with their backs to the camera, which was positioned to capture a view of the drawings. Throughout, the mentor highlighted aspects of the drawings using different coloured pens. During select portions of the session, the mentee annotated as well.

The partial view of the back of the participants’ heads precluded further non-verbal analysis of this session, but it was clear that significant back and forth occurred. In future studies, a two camera setup would be advantageous.

The participants—not the researcher or recording facility staff—directed camera location, without any predetermination of what, in particular, should be captured. This was one of many procedural decisions that attempted to mitigate experimenter bias, and some consequences regarding data capture should have been expected. In retrospect, this approach would not be altered in future studies, due the approach’s reduced artificiality, increased agency on the part

of participants, and cascading impacts, most of which have been judged as positive and in alignment with study goals.

2.5 Session 5 (55m 54s)

The mentor brought two books to the session to share with the mentee. The mentor referenced both books in relationship to their ongoing discussions. Throughout, the mentor referred to illustrations or diagrams in the books and drew on a whiteboard to provide diagrammatic explanations to supplement their discourse.



Figure 11: Turn taking in Session 5

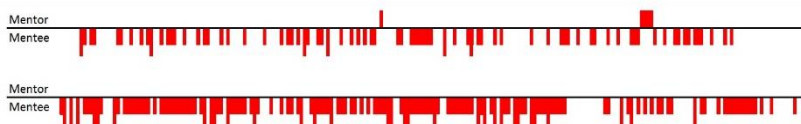

Figure 12: Nodding in Session 5 (Session 2 above, for reference)

Based purely on the data, Session 5 seemed to be an even more one-sided affair than Session 2, with the mentor presenting (Figure 11) and the mentee nodding along while taking the floor five times very briefly and offering interjections sporadically. However, when one compares head nodding against Session 2 (Figure 12), a real contrast is drawn. Mentor nodding has disappeared completely, while the mentee's nodding frequency has increased **176.6%** over Session 2. How this should be interpreted is not completely clear.

One notional explanation is that mentor was engaged/focused on presenting—to the exclusion of attending to mentee non-verbal behaviours—thus no mirroring. Coders were asked to assess whether mirroring existed during each 15 second interval, with **yes** blue and **no** white in Figure 13. No correlation between coder assessments and observed (fidgeting) behaviours was evident. Observed fidgeting behaviours are colour coded (mentor, above) and (mentee, below) the assessment line. There is no mirroring evident in the observed fidgeting, therefore the notional explanation above is supported by the available evidence.

However that explanation could easily be supplanted by a notional explanation like “the mentor no longer felt it necessary to mirror due to his higher level of comfort with the process and the mentor/mentee relationship, thus did not display behaviour (mirroring) associated with social construction of identity or relationship.” There is no way to distinguish between the two explanations, so their explanatory value is limited.

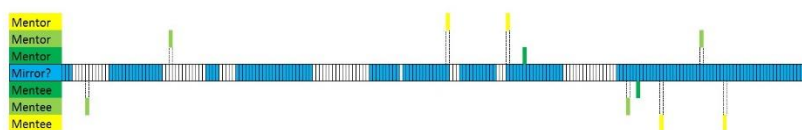

Figure 13: Mirroring and observed fidgeting in Session 5

2.6 Session 6 (1h 2m 37s)

After reviewing mentor suggested documentaries and readings between sessions, and completing a “homework” assignment, the mentee briefly presented his findings. The mentor then elaborated on the mentee’s work using an iPad and whiteboard for supplementary visual support, with the pair advancing the design.

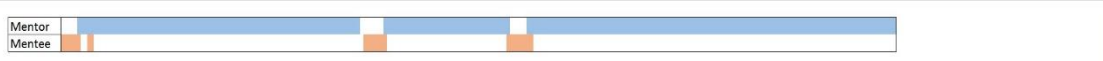

Figure 14: Turn taking in Session 6



Figure 15: Nodding in Session 6

The overlaps seen in Figure 14 are notable by their absence in previous sessions. Talking over each other is a sign of collegiality and indicative of a baseline of comfort between participants. Head nodding on the part of the mentor has returned. Most interesting is the presence of an extended pause at the 22:30 interval. Pauses are called ‘uncomfortable’ for a reason. They can only exist in an interpersonal milieu that allows them to go unfilled.

2.7 Session 7 (1h 15m 46s)

Throughout this session, the mentor shared a full-size set of progress drawings with the mentee and highlighted details using black, red, and blue pens. The mentor also demonstrated how to advance the current design using trace paper for sketching and calculations. The mentee provided significant input.

The participants have grown more comfortable working together. The social distance between them has noticeably lessened. They seemed to anticipate each other’s actions, even down to such minutiae as handing each other pens without prompting, sharing a calculator, calculating in advance while the other sketches, and locating specific sketches without being asked. They no longer seem to remember they are “on camera.”

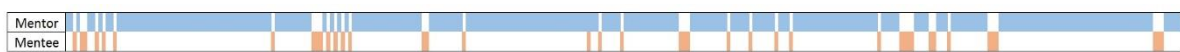

Figure 16: Turn taking in Session 7



Figure 17: Nodding in Session 7



Figure 18: Sketching in Session 7

Turn taking occurred in a rapid fire manner during this session, the most collaborative yet. Nodding density was lower on both sides, but more counterbalanced. The sketching was predominately the mentor’s, but significant ad hoc mentee sketching activity was observed.

2.8 Session 8 (51m 2s)

The mentor and mentee periodically referred to an iPad or the projection of the iPad's screen during this session. The interaction is much more detailed and specific, with the mentee asking very specific questions and the mentor answering questions in great detail.



Figure 19: Turn taking in Session 8



Figure 20: Nodding in Session 8

Though one-sided, this session returned to a more discursive format. When the mentee did interject, he was comfortable talking over the mentor and taking the floor. Nodding was more balanced, consistent with similarly formatted sessions, but frequency was lower overall.

3. DISCUSSION

These two months of sessions represent a mini longitudinal case study of mentorship. Indicators such as proximity and the angle at which the participants sat showed a clear progression from more formal to more intimate as seen in Figure 21, a composite of video screenshots spanning Session 1, 6, and 8 (from left to right).



Figure 21: Interpersonal distance in Sessions 1, 6, and 8

Some metrics, such as turn taking, are more format dependent than others. This does not mean that a progression or trend was not observed. In the case of turn taking, overlaps were initially absent, then appeared in later discursive sessions as familiarity increased. Head nodding displayed an interesting two track progression, with frequency initially increasing, then decreasing over time. It appeared to be particularly associated with defining, or reinforcing, personal or organizational identity, as one of many facets of the construction of the relationship between mentor and mentee.

The approach involved interpretation. Since the discourse involved a mentor and mentee who knew that their interactions were being recorded, mitigating experimenter bias required an approach grounded in transparency and a reliance on sheer volume of interaction to dilute the effect. Sessions were obviously recorded; the hope was that the status quo of being recorded would fade into the background. Based on the available evidence from the data collected and analysed, a 'sea change' from "surveillance skewing behaviour" to "indifference to being

observed," occurred around Session 6 of 8. The complete lack of involvement of the investigator (the author) may have helped in this regard.

4. CONCLUSION

Without mentorship, knowledge transfer will still occur. With mentorship the efficacy of knowledge transfer and organizational continuity will be greatly enhanced. Understanding what really goes on during mentoring sessions is the foundation for lasting improvement of mentorship programs. This study is the first step in that process. Based on the below:

“Every discourse, whether between individuals or groups is unique in time, space and participants and cannot be revisited. Process ontology views every individual as an evolving product of every experiential encounter, and so their immersion in any part of the organization’s river of discourse is an unrepeatable experience. Both the organizational discourse and the individual will have changed as a result of previous immersions” (O’Rourke & Dufy, 2012).

...it is clear that such interactions are inherently unique. Further, their multifaceted nature has the potential of being mined for understanding which could be applied to improve critical processes. Mentorship is a critical aspect of long term competitive advantage which must be improved, promoted, and become ubiquitous.

5. REFERENCES

- Bell, L., van Waveren, C.C., and Steyn, H. 2016. Knowledge-sharing within the project-based organization: A knowledge-pull framework. *South African Journal of Industrial Engineering*, 27(4), pp.18-33. [1]
- Bitsch, V. 2005. Qualitative research: A grounded theory example and evaluation criteria. *Journal of Agribusiness*: 23(1) pp. 75-91.
- Boisot, M.H. 1995. *Information space: A framework for learning in organizations institutions and cultures*. London, U.K., Routledge. [2]
- Boisot, M.H. 1998. *Knowledge assets: Securing competitive advantage in the information economy*. Oxford, U.K., Oxford University Press. [3]
- Chartrand, T. & Bargh, J. 1999. The chameleon effect: The perception-behavior link and social interaction. *Journal of Personality and Social Psychology*: 76(6) pp. 893-910.
- Costa, R., Lima, C., Sarraipa, J., and Jardim-Gonçalves, R. 2016. Facilitating knowledge sharing and reuse in building and construction domain: An ontology-based approach. *Journal of Intelligent Manufacturing*, 27, pp.263–282. [8]
- Dougherty, J.U. and Parfitt, M.K. 2013. Student and practitioner collaboration in an online knowledge community: Best practices from a capstone course implementation. *Journal of Architectural Engineering*, 19(1), pp.12-20. [10]
- Eby, L.T., Allen, T.D., Evans, S.C., Ng, T., and DuBois, D. 2008. Does mentoring matter? A multidisciplinary meta-analysis comparing mentored and non-mentored individuals. *Journal of Vocational Behavior*, 72(2), pp.254-267. [11]
- Hall, E. 1966. *The Hidden Dimension*. Garden City, NY: Doubleday.
- Hari, S., Egbu, C., and Kumar, B. 2005. A knowledge capture awareness tool: An empirical study on small and medium enterprises in the construction industry. *Engineering, Construction and Architectural Management*, 12(6), pp.533-567.
- Hernandez, P.R., Estrada, M., Woodcock, A. and Schultz, P.W. 2016. Protégé perceptions of high mentorship quality depend on shared values more than on demographic match. *The Journal of Experimental Education*, 1(1), pp.1–19. [15]
- Hoffmeister, K., Cigularov, K.P., Sampson, J., Rosecrance, J.C. and Chen, P.Y. 2011. A perspective on effective mentoring in the construction industry. *Leadership & Organization Development Journal*, 32(7), pp.673-688. [16]

- Hunt, D.M. and Michael, C. 1983. Mentorship: A Career Training and Development Tool. *The Academy of Management Review*, 8(3), pp.475-485. [17]
- Kaskutas, K., Dale, A.M., Lipscomb, H. and Evanoff, B. 2013. Fall prevention and safety communication training for foremen: Report of a pilot project designed to improve residential construction safety. *Journal of Safety Research*, 44, pp.111-118. [18]
- Leonard, D., Swap, W. and Barton, G. 2015. *Critical knowledge transfer: Tools for managing your company's deep smarts*. Boston, Harvard Business Review Press. [20]
- Lester, E. 2017. Unpublished.
- Liem, A. 2009. Providing students with a head start through mentorship and systems thinking within a vertical design studio environment. *International Journal of Product Development*, 9(4), pp.357-369. [21]
- Mehrabian, A. 1981. *Silent Messages: Implicit Communication of Emotions and Attitudes* (2nd ed.). Belmont, CA: Wadsworth.
- Nicholas, D. and Anandan, S. 2017. The novel design research lab experience: Teaching and trans-disciplinary mentorship for 21st-century science, engineering and design students. *INTED2017 Proceedings*, pp.9467-9473. [23]
- Nonaka, I. and Takeuchi, H. 1995. *The knowledge-creating company: How Japanese companies create the dynamics of innovation*. Oxford, Oxford University Press. [24]
- O'Rourke, B. & Dufy, M. 2012. Strategic discourse across organizational meetings: Towards a systems perspective. PROS: Fourth International Symposium on Process Organization Studies: Language and Communication @ Work. 21-23 June 2012, Kos, Greece. Retrieved from: www.process-symposium.com [accessed 14 April 2017].
- Ordman, N. 2017. Pulse of Engineering: Where Are the New Engineers? *Engineering 360° IEEE GlobalSpec*. [Online] 1-3. Retrieved from: <http://insights.globalspec.com/article/4185/pulse-of-engineering-where-are-the-new-engineers> [accessed 2 April 2017].
- Palmer, J.C., Birchler, K.D., Narusis, J.D., Kowalchuk, R.K., and DeRuntz, B. 2016. *Leading the way: A review of engineering leadership development programs*. 123rd ASEE Annual Conference and Exposition, 26th – 29th June, 2016, New Orleans, LA. [25]
- Pathirage, C.P. 2007. *A structured approach to manage the tacit knowledge of construction employees*. PhD Dissertation. The University of Salford. [26]
- Pathirage, C.P., Amaratunga, R.D.G. and Haigh, R.P. 2006. Managing construction workers and their tacit knowledge in a knowledge environment: A conceptual framework. In: *6th International Postgraduate Research Conference in the Built and Human Environment*, 6-7th April 2006, Delft University of Technology and TNO, Delft University, Netherlands. pp.730-743. [27]
- Payne, S.C. and Huffman, A.H. 2005. A longitudinal examination of the influence of mentoring on organizational commitment and turnover. *The Academy of Management Journal*, 48(1), pp.158-168. [28]
- Raabe, B. and Beehr, T.A. 2003. Formal mentoring versus supervisor and coworker relationships: Differences in perceptions and impact. *Journal of Organizational Behavior*, 24(3), pp.271-293. [29]
- Ralph, E.G. and Walker, K.D. 2014. Mentorship in the practicum: Post-interns' perspectives. *International Journal of Humanities and Social Science*, 4(8), pp.1-10. [30]
- Reidy, H. 2009. Coach and counsellor. *Professional Engineering*, 22(2), pg. 38. [31]
- Shaurette, M. and Scott, L. 2012. Toward an understanding of research fundamentals to support graduate education in the built environment. *CIB International Conference on Management of Construction: Research to Practice*. Montreal, Canada, pp.294-306. [33]
- Silverthorne, S. 2002. *Mentoring – Using the Voice of Experience*. Harvard Business School: Working Knowledge. [Online] Retrieved from: <http://hbswk.hbs.edu/item/mentoring-using-the-voice-of-experience> [accessed 8 April 2017].
- Swap, W., Leonard, D., Shields, M. and Abrams, L. 2001. Using mentoring and storytelling to transfer knowledge in the workplace. *Journal of Management Information Systems*, 18(1), pp.95-114. [37]

SCENARIO MANAGER: INNOVATIVE CONCEPT FOR PROCESS AND INFORMATION MANAGEMENT

M.-C. Loeffler¹, G. Calleja-Rodriguez², R. Guruz³

¹ BAM Deutschland AG, Stuttgart, Germany

² CEMOSA, Malaga, Spain.

³ TECHNISCHE UNIVERSITÄT DRESDEN, Institute of Construction Informatics, Germany

Email: M.Loeffler@bam-deutschland.de

Abstract: Sustainable developments require an intensive collaboration of many experts. The purpose of this research is to develop a method and a concept for a supporting tool called Scenario Manager (ScM) that structures the collaborative work and monitors the progress against the design objectives. Hence, it proposes the standardisation of design processes with the Information Delivery Manual (IDM) and the integration of a Level of Information (LOI) framework to verify the quality of the model. In addition, it defines Key Points for the quality control of the design and for decision-making. Scenario Manager (ScM) is developed to support the design team with the set-up and tracking of requirements, processes and information exchanges. The complete design team (architects, engineers, contractors and facilities managers) can improve the process efficiency with the support of the ScM and its process management capabilities.

Keywords: Building Information Modelling (BIM), BIM Execution Plan (BEP), Information Delivery Manual (IDM), Level of Information (LOI), Scenario Manager (ScM)

1. INTRODUCTION

Designing sustainable buildings and energy systems optimally embedded in their neighbourhood with many experts involved and many design alternatives to be evaluated requires a systematic design process. Building Information Modelling (BIM) can improve the efficiency of the design process as it is defined which information is needed at a given milestone to make a decision. The authors of this paper highlight the importance of using BIM and integrating collaboration for sustainable construction projects. For that purpose, the project team should set up a BIM Execution Plan (BEP) as well as develop and monitor it continuously during the project. The aim of a BEP is to increase the efficiency and consistency of BIM collaborative design and enhance the quality of information delivered to stakeholders involved in the project life cycle. The Information Delivery Manual (IDM) developed by buildingSMART and published as the ISO Standard 29481-11 is a valuable method to standardise the design processes. Thereby, the processes are developed regarding the business goals and the exchanges between the participating actors and tools. IDM methodology is increasingly used as it has solved many issues in collaborative BIM projects. However, analysing the existing software and platform tools in a gap analysis and comparing them to the set of functionalities required by the end-users in the eeEmbedded project, it has been identified a lack of integrated software with the capability to set up and track the processes and the capabilities to capture and track information exchanges and information level agreements. To address those needs, the concept of a new tool – the Scenario Manager (ScM) - will be provided. Scenario Manager will allow the project team to set up and structure the requirements, define the Level of Information (LOI) at each milestone, identify roles, tasks and exchanges as well as the verification and validation methods.

2. RESEARCH METHODOLOGY

The main objective of this research is to develop a consistent information management system and a decision platform for the collaboration of all project participants. Standardised collaborative design processes need to be defined and a way to digitally capture and track these processes and information exchanges needs to be identified for this aim. The following research methodology has been used. First of all, the state-of-the-art literature review has been carried out and gaps have been identified. The gap analysis is a technique that businesses used to find out what steps need to be taken in order to move from its current state to its desired future state. In this work, the gap analysis consisted of 3 steps: 1) listing features of current work processes and tools, 2) listing features that are needed to achieve future objectives and 3) identify gaps that exist and are needed to be filled in or addressed (Geißler, et al., 2014).

Based on the findings, the functional requirements and graphical user interface for a tool support have been developed. This concept has been presented to end-users from the Architecture, Engineering and Construction (AEC) industry during web conference series and workshops. The feedback has been collected and integrated in the development of the Scenario Manager (ScM). Finally, the functionalities have been improved and the benefits identified in an intensive testing phase with two real pilot projects.

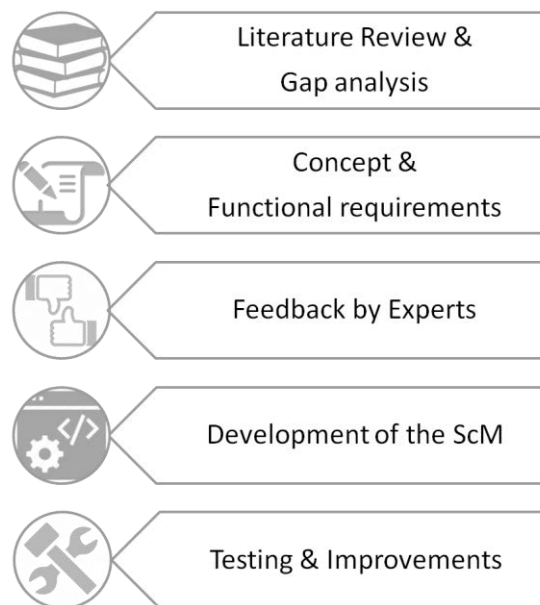

Figure 1: Research Methodology [Conceptualised by authors]

3. LITERATURE REVIEW

A number of references identify the importance of addressing the collaboration and management aspects in BIM-based projects (Calleja-Rodriguez & Guruz, 2014), (Kassem, et al., 2014), (Oh, et al., 2015), (Singh, et al., 2011). For example, (Tarandi, 2015) points out that advanced information systems are required in order to collect, store, process, integrate, extract, visualise and interpret all the information. In this case, a BIM collaboration lab based on the concept of a BIM repository is proposed to support stakeholder collaboration and information management. On the other hand, (van Berlo & Krijnen, 2014) identifies the need to facilitate exchange of information regarding the status of BIM objects and the need to present a real-

time and comprehensive overview of the project to the project manager and client. It is proposed to solve these needs by means of the concept of a central server for storing data related to issue and status management for BIM models and elements. Specifically, the chosen solution approach is to develop (1) a BIM Collaboration Format (BCF) server that stores and allows retrieving BCF issues and (2) a BCF dashboard in order to present an up-to-date issue listing to the end-user in context of the 3D BIM model and a revision timeline. The BIM server is used for project and revision management of IFC data. In the AEC market, several common data environment software is available such as (Allplan, 2017), (Aconex, 2017) to facilitate collaboration and information management.

All these solutions based on a common data environment or repositories are quite useful and necessary for BIM-based projects. However, all the issues related to collaboration and management cannot be solved with them. Important functionalities, such as tracking of processes, tasks, solution quality are missing according to the literature review and gap analysis carried out.

In this line, (Eissa, et al., 2017) analyses ICT and collaborative practices adopted on BIM-based projects and found out that emails, face to face meetings and web conferencing services are widely used for communication. However, most companies use proprietary web-based collaboration tools and electronic document management systems such as (Bentley, 2017), (Autodesk, 2017) and (Viewpoint, 2016) to manage and share project data among team members. There are also companies using (Atlassian, 2017) for management of BIM projects although this software is not specifically created for BIM. (Eissa, et al., 2017) also states that BIM related standards provide a good starting point for developing a collaborative BIM approach, but it does not overcome all issues as there are still limitations. For that reason, features of a BIM governance framework with support of cloud technologies to guarantee successful collaboration have been investigated.

According to the literature review and gap analysis, the above mentioned solutions present valuable functionalities, but do not address all the relevant aspects of BIM-based processes such as exchange requirements (Lee, et al., 2016) or Level of Development (BIMForum, 2015), (NATSPEC, 2013).

In order to overcome the above mentioned gaps, the concept of a BIM Execution Plan (BEP) as per ISO 19650-2 is proposed for managing projects. This BEP should be a direct response to the Employer Information Requirements (EIR) which defines the information required at each key decision point in the process. Among others, Pennsylvania State University provides a structured procedure for creating a BEP (The Pennsylvania State University, 2011):

1. Defining high value BIM uses during project planning, design, construction and operational phases
2. Using process maps to design BIM execution
3. Defining the BIM deliverables in form of information exchanges
4. Developing a detailed plan to support the execution process

Information Delivery Manual (IDM) is a valuable methodology that can be used to define the BEP. It is the buildingSMART approach published as an ISO standard (International Organization for Standardization, 2016) to develop standardised processes and information exchanges which is based on the process maps, Exchange Requirements (ER) and Model View

Definition (MVD). In general, it can be said that IDMs offer standardised methods to answer the following questions:

- Who needs the information extracted from the building information model?
- At which point in time this information is needed?
- Which minimal amount of data has to be exchanged?

The essential parts of this information delivery manual are:

- Defining "who" and "when" by means of general process maps developed with the support of Business Process Modelling Notation (BPMN).

Figure 2 describes the steps to develop an IDM for a specific use case: IDM step 1: Identify Processes and Actors → IDM step 2: Identify Exchanges → IDM step 3: Create Exchange Requirements → MVD step 1: Extend to Exchange Requirements Model → MVD step 2: Unify to Model View Definition.

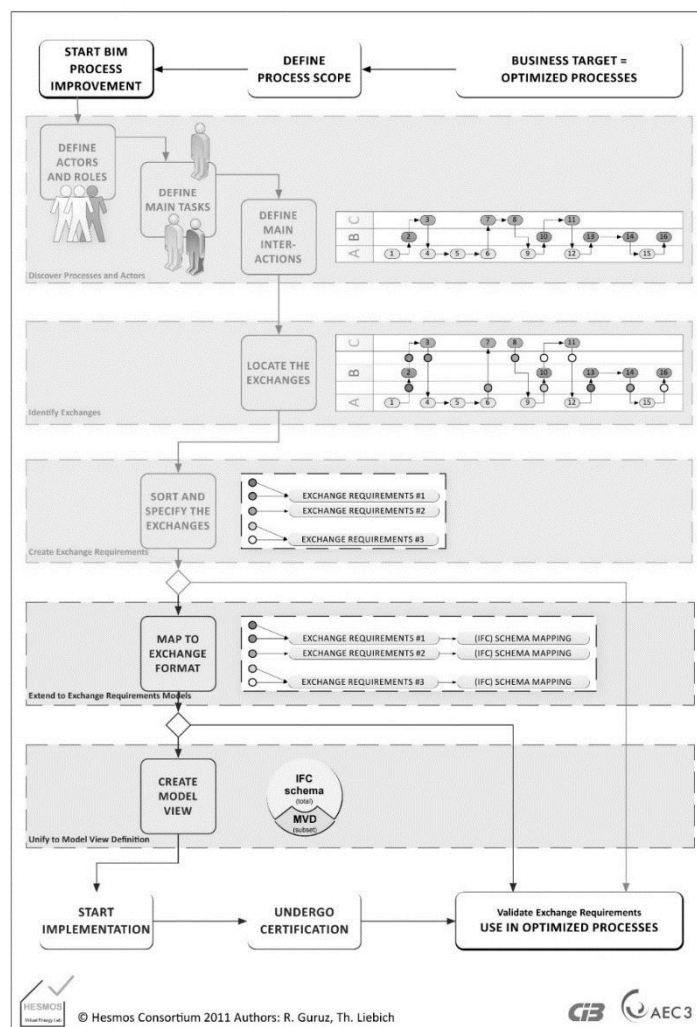

Figure 2: Information Delivery Manual Method (Liebich, et al., 2013)

(Mondrup, et al., 2014) identified that IDM often describes complex processes which are difficult to manage and to implement in real projects. Therefore, a modular approach breaking

down in small generic IDM packages, which can then be combined and adopted for specific projects (project scope, sequence flow & interaction) in an IDM project plan, is proposed. Nowadays, the BEP with the processes and information exchanges are often developed based on paper. The NBS BIM toolkit, a free-to-use online tool, is a proposed approach to digitalise a BEP. The digital plan of work seeks to ensure that all participants are producing information at the right time and in the right way. It has a library of Level of Detail (LoD) and Level of Information (LOI) specifications and is classified through a unified classification system. In addition, it gives project teams the ability to define roles and responsibilities.

The xPPM is another valuable tool to analyse. Process maps can be created on the process modelling interface. After specifying the process, the Exchange Requirements (ER) can be specified by reading existing ER or defining additional ones. In the Industry Foundation Classes (IFC) menu information items can be specified in context of IFC (Lee, et al., 2013).

From the perspective of this research, there are valuable approaches in the right direction. However, there is a great potential to combine and integrate the approaches to develop an interactive tool for processing and managing information. Progress monitoring compared to what was planned is not, but should be supported and the ERs should be checked and communicated. Both digital tools are focused on the information exchange, but neglect the integration of the requirements' compliance check. For that reason, a new design method with Key Points (KP) is proposed (Geißler, et al., 2014), (Guruz, et al., 2015). The new method aims at providing the interoperability of the design goals and monitoring the progress of the design. The Key Points are metric units used to check designs. There are three hierarchical types of Key Points: Decision Values (DV), Key Performance Indicators (KPI) and Key Design Parameters (KDP). Figure 3 shows an overview of this method. It illustrates the pyramid structure of Key Points as well as the two main stages of the new method: (1) requirements decomposition and (2) results aggregation.

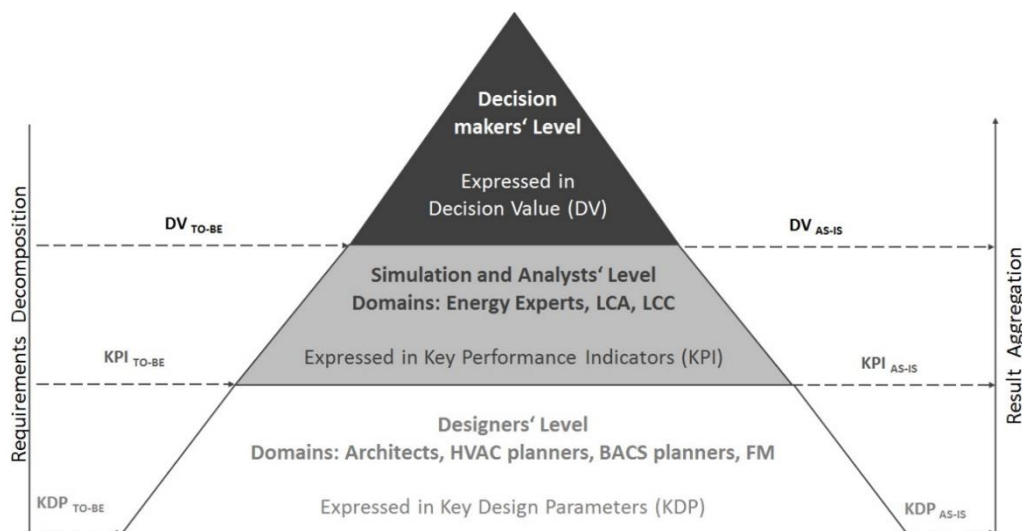

Figure 3: Key Point pyramid for checking the requirements and results (Guruz, et al., 2015)

4. RESULT: SCENARIO MANAGER (SCM)

The need of task driven collaboration on the basis of the IDM is addressed with the development of the Scenario Manager (ScM). The ScM supports the set-up of a digital BIM

Execution Plan (BEP) which enables the project coordinator to set up and track the processes as well as to capture and track the Level of Information (LOI) agreements.

4.1 Scenario manager set-up

The main structure of the ScM follows the planning procedures according to the following steps: (1) project level, (2) phase and process level and (3) task and subtask level.

Level I: Project

1. Project set-up: the main information regarding the project will be collected here: project name, brief description, building type and information related to budget and duration. Moreover, the contact data of clients and all participating companies are registered and the available software tools are compiled.
2. Level of Information (LOI) set-up: required LOI is defined in a pre-structured table which enables an easy interlinking with the responsible process participants.
3. Key Points set-up: project goals and requirements are entered in the Key Point structure. A consistency check is carried out to ensure a good quality of the target values.

Level II: Phase and process

4. Process set-up: at this step, the project manager can start to create via drag and drop a full process for each project phase based on the predefined goals.

Level III: Task and Subtask

5. Task set-up: this is the most detailed level. The user can find detailed information about the subtasks to do, as well as related information regarding ERs, KPs etc.

4.2 Scenario manager progress report

When the project is set up in the Scenario Manager, the design process can start. After completing his/her task, design partners release their work results for the next participants in the scenario. It will be automatically checked based on the defined Exchange Requirements (ER) when the work is released. The resulting work cannot be released and the responsible partner is informed about missing information when the ER check fails. If the ER has enough quality, the Key Points (KP) are checked. If the KP check fails, the work is not released and the design partner is informed via a BIM Collaboration Format (BCF) message what s/he needs to rework. On condition that the KP check succeeds, the results are delivered on the basis of the process model to the next partner via BCF. The successor receives the BCF message and begins his/her task. This process support helps the design partners to effectively conduct their work because the automatically check ensures s/he got the needed information to perform his/her task. The Scenario Manager also supports the project coordinator to monitor project progress.

4.3 Scenario manager demonstrator

Figure 4 shows a demonstrator of the ScM. The ScM consists of a project explorer, scenario explorer and messaging & properties explorer. All data (including requirements) stored in the project repository and inter-linked via a link model can be accessed using the project explorer. The project coordinator is able to define the process maps by dragging and dropping BPMN elements from the process setting palette (tasks, actors, Key Points, ER, etc.) within the scenario explorer. Responsible persons can be assigned for every task in the process map, Key Points and ERs. New Exchange Requirements (ER) can be created or existing ERs can be read and used or adapted. To monitor the process and facilitate collaboration, the tasks in progress are highlighted and the status is communicated via BIM Collaboration Format (BCF) messages. In addition, deviations are sent as BIM snippets via BCF to the authoring tool after verification of the models, so that the designer can adapt the model.

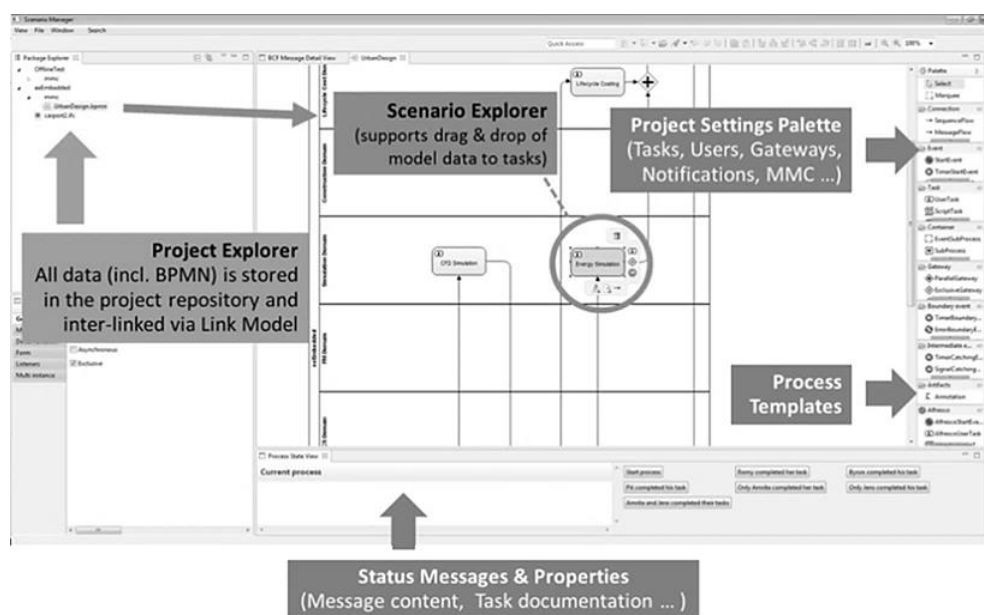

Figure 4: Scenario Manager Demonstrator [development eeEmbedded project]

5. CONCLUSIONS & DISCUSSION

This article discusses the need for a Scenario Manager to guide and monitor the progress of the multi-disciplinary design. The Information Delivery Manual (IDM) was recognised as a valuable method and extended by a Key Point (KP) framework which provides control of the sustainable design quality. A Scenario Manager tool (ScM) will be developed to improve the BIM Execution Planning (BEP) and most important the monitoring of the processes. Some efforts have been done in practice to develop a platform to set up a BEP. Such a platform is of great support when setting up and structuring the project, which is currently done paper based. Nevertheless, there is the need to use the specified data in the digital BEP to monitor the progress and to facilitate collaboration. The greatest benefit of the Scenario Manager is that the model and design quality can be checked based on the set-up of LOI and KP. It guarantees that the design partner has the information s/he needs and that s/he is informed when the model or design quality is not sufficient. This can improve the efficiency, reduce unnecessary iterations and improve the design quality.

6. ACKNOWLEDGEMENTS

The work presented in this document has been conducted in the context of the seventh framework programme of the European community project “Optimised design methodologies for energy-efficient buildings integrated in the neighbourhood energy systems [eeEmbedded, n° 609349]” funded by the European Commission and the industrial project partners. Their support is gratefully acknowledged.

7. REFERENCES

- Aconex, 2017. *Aconex Solutions*. [Online] Available at: <https://www.aconex.com/solutions> [Accessed 14 July 2017].
- Allplan, 2017. *BIM+*. [Online] Available at: <https://bimplus.net/> [Accessed 14 July 2017].
- Atlassian, 2017. *Jira Software Features*. [Online] Available at: <https://www.atlassian.com/software/jira/features>. [Accessed 14 July 2017].
- Autodesk, 2017. *Revit Products*. [Online] Available at: <https://knowledge.autodesk.com/support/revit-products> [Accessed 14 July 2017].
- Bentley, 2017. *ProjectWise*. [Online] Available at: <https://www.bentley.com/en/products/brands/projectwise> [Accessed 14 July 2017].
- BIMForum, 2015. *Level of Development Specification*. [Online] Available at: <http://bimforum.org/lod/> [Accessed 14 July 2017].
- Calleja-Rodriguez, G. & Guruz, R., 2014. *eeEmbedded Deliverable D1.3: Interoperability and collaboration requirements*, Brussels: eeEmbedded Consortium.
- Eissa, A., Mourshed, M. & Rezgui, Y., 2017. Factors for effective BIM governance. *Journal of Building Engineering*, Volumen 10, pp. 89-101.
- Geißler, M. C., Guruz, R. & van Woudenberg, W., 2014. *eeEmbedded Deliverable D1.1: Vision and requirements for a KPI-based holistic multi-disciplinary design*, Brussels: eeEmbedded Consortium.
- Geißler, M. C., Guruz, R. & van Woudenberg, W., 2014. *eeEmbedded Deliverable D1.2: Use case scenarios and requirements specifications*, 2014: eeEmbedded Consortium.
- Guruz, R., Calleja Rodriguez, G. & Geißler, M. C., 2015. *eeEmbedded D2.1 Holistic multi-disciplinary Key Point-based design Framework*, Brussels: eeEmbedded Consortium.
- International Organization for Standardization, 2016. *ISO 29481-1:2016 Building information models -- Information delivery manual -- Part 1: Methodology and format*. s.l.:s.n.
- International Organization for Standardization, 2017. *ISO/DIS 19650-2 Organization of information about construction works - Information management using building information modelling - Part 2: Delivery phase of assets*
- Kassem, M. et al., 2014. Building Information Modelling: Protocol for collaborative design processes. *Journal of Information Technology in Construction (ITcon)*, Volume 19, pp. 126-149.
- Lee, G., Hyun Park, Y. & Ham, S., 2013. Extended Process to Product Modelling (xPPM) for integrated and seamless IDM and MVD development. *Advanced Engineering Informatics*, 27(4), pp. 636-651.
- Lee, Y., Eastman, C. & Solihin, W., 2016. An ontology-based approach for developing data Exchange Requirements and model views of building information modelling. *Advanced Engineering Informatics*, Volumen 30, pp. 354-367.
- Liebich, T. y otros, 2013. *HESMOS D+ Additional Deliverable Information Delivery Manual Work*, Brussels: HESMOS Consortium.
- Mondrup, T. F., Tredal, N., Karlshøj, J. & Vestergaard, F., 2014. *Introducing a new framework for using generic Information Delivery Manuals*. Vienna, CBC Press.
- NATSPEC, 2013. *BIM and LOD Construction Information Systems Limited*. [Online] Available at: <http://bim.natspec.org/> [Accessed 14 July 2017].
- Oh, M., Lee, J., Wan Hong, S. & Jeon, Y., 2015. Integrated system for BIM-based collaborative design. *Automation in Construction*, Volumen 58, pp. 196-206.
- Singh, V., Gu, N. & Wang, X., 2011. A theoretical framework of a BIM-based multi-disciplinary collaboration platform. *Automation in Construction*, 20(2), pp. 134-144.
- Tarandi, V., 2015. *A BIM collaboration lab for improved through life support*. Tampere, Kähkönen Kalle.
- The Pennsylvania State University, 2011. *BIM Project Execution Planning Guide version 2.1*. Pennsylvania: s.n.
- van Berlo, L. & Krijnen, T., 2014. *Using the BIM Collaboration Format in a server based workflow*. Eindhoven, Harry Timmermans.

Viewpoint, 2016. *Viewpoint for projects*. [Online] Available at: <https://en-b.viewpoint.com/products/viewpoint-for-projects>[Accessed 14 July 2014].

TRANSFERRING KNOWLEDGE FROM BUILDING OPERATION TO DESIGN – A LITERATURE REVIEW

H. L. Rasmussen, P. A. Jensen and J. S. Gregg

*Management Engineering, Technical University of Denmark,
Produktionstorvet Building 424, 2800 Kgs. Lyngby, Denmark*

Email: helr@dtu.dk

Abstract: As a solution to the previously identified gap between expected and actual building performance, this paper investigates how knowledge can be transferred from operation to design. This is assumed to help bridge the gap and increase the performance of new built facilities. By conducting a systematic literature review, it is found, that the theoretical approach in the reviewed articles has a significant impact on the level of how applicable the recommendations are in practice. Furthermore, a list of identified tools to enable knowledge transfer is provided, including POE, PPP and building commissioning. Knowing that the list lacks inputs from cultural and organizational theory, the paper suggests that further research should focus on taking these suggestions to an operational level for the benefit of FM, building clients and design teams. Furthermore, it is found that major concepts that could be considered helpful to secure operational knowledge in design, such as Soft Landings and certification schemes like DGNB, are almost absent in the selected literature. This indicates that they are not recognized, and therefore not researched, as methods for knowledge transfer. Several countries, such as US, UK, Denmark, Saudi Arabia, and Malaysia are represented in the review.

Keywords: Building Performance Optimization, Construction Management, Facilities Management, Knowledge Transfer, Performance Gap

1. INTRODUCTION

When a new built facility is handed over from construction to operation, the building owner, facilities manager or facility users frequently experience a gap between the expected performance and the actual performance. Concerning energy consumption, literature describes a reliability gap between the calculated and the actual energy consumption (Ornetzeder et al. 2016, Mills 2010). In addition to energy efficiency, other aspects of building performance have been recognized to be deficient: lack of functionality, poor indoor climate, difficulties in operation and maintenance, and poor cleaning possibilities (Jensen 2012, Hansen & Damgaard 2012).

The reduced performance in facility operation persists until changes can be implemented, though some deficiencies are likely to be permanent once the facility is in operation. Changes may consist of adjustment or replacement of parts of the technical installations, physical changes or addition in the building, and/or changes in human behaviour. The reduced building performance - and the often expensive changes needed to increase performance and bridge the gap - has a negative impact on the environment, economy, productivity, and life quality for end users and operation staff.

As awareness of the importance of sustainability is consolidating in society, policymaking and among building owners, there is an increasing demand that the building industry contributes to bring down energy consumptions (Mills 2010, Way 2005, Sunikka-Blank & Galvin 2012). Furthermore, awareness of the importance of proper indoor climate and working environment

for employees, including operation and maintenance personnel, increases. This makes continued efforts to increase building performance ever more important.

This paper is based on earlier research suggesting that integrating operational knowledge in design stages can help bridge the performance gap (Jensen 2012, Hansen & Damgaard 2012, Way 2005). Particularly The design stage in particular has been identified as crucial for two main reasons. First, difficulties in operation are often caused by faults in design, rather than faults in construction (Alhaji Mohammed & Hassanain 2010). Second, because changes are more easily made during design than during construction; during operation some changes are impossible to implement.

The importance of integrating operational knowledge in design seem acknowledged by the building industry as several concepts, for example Building Commissioning (Mills 2010), Continuous Briefing, and Post Occupancy Evaluation (POE) (Jensen 2012) include elements of knowledge transfer from operation to design. Despite these efforts, recent studies (Ornetzeder 2016) indicate that the performance gap has not yet been bridged, and transferring knowledge is not easily done.

The purpose of this study is therefore to investigate the state of the literature with respect to how knowledge can be transferred efficiently from operation to design, since this has been acknowledged as being helpful to bridge the performance gap within the building industry. By conducting a systematic literature review, we aim to clarify what current theory tells us to do to solve the problem of insufficient knowledge transfer. First, we gather a list of available tools to get an overview of practical recommendations. Second, we examine how differing theoretical fields contribute to solve the problem. This approach gives a basis for investigating if current theory fully incorporate the complexity of the phenomenon of knowledge transfer from operation to design. The study is of relevance, because it puts forward an explanation for the failure of successive attempts to enable knowledge transfer in building projects and thereby appoints direction for further research.

2. METHODOLOGY – A SYSTEMATIC LITERATURE REVIEW

A systematic literature review was conducted to assess how the literature describes knowledge transfer from building operation to design. The review is based on principles outlined in Okoli and Schabram (2010) and Webster and Watson (2002). Okali and Schabram (2010) provide “eight steps for systematic review” and Webster and Watson (2002) provide guidelines on searching for literature in three directions: using keywords, following the references in the selected papers, and then looking for papers that cited the selected papers (keyword, backward and forward).

In order to identify the most appropriate words to apply to the keyword search, a ‘word counter’ was used on a few highly relevant articles already known to the authors (title, keywords and abstract). To this end, the 25 most frequently used words were grouped based on their similarities in the meaning and then applied as keywords for the search of the relevant articles (Table 1).

A keyword search with Boolean operators (Table 1) was conducted within the Scopus multidisciplinary database, provided by Elsevier. A certain degree of testing the search strategy was needed, leading to adjustments. Having successfully conducted a simple test searching for

highly relevant articles already known to the authors, Scopus was found suitable and, with access to more than 50 million records, sufficient for this review. The search returned 264 documents.

Table 1: Boolean Operators

Search terms						
knowledge	<i>and</i>	transfer	<i>and</i>	“building operation”	<i>and</i>	“building design”
<i>Or</i>		<i>Or</i>		<i>Or</i>		<i>Or</i>
“Know how”		sharing		“operations and maintenance”		construction
		<i>Or</i>		<i>Or</i>		<i>Or</i>
		“feed back”		“facilities management”		“hand over”
		<i>Or</i>		<i>Or</i>		<i>Or</i>
		management		“facility management”		Design
		<i>Or</i>		<i>Or</i>		
		integration		FM		

From here, the following practical screens were used:

Language: English.

Sources: Peer reviewed articles. Books were omitted because research is often published in articles alongside books. Conference papers were also omitted, as they turned out upon examination to be either irrelevant or publications identified as earlier work to some of the included papers.

Date: papers published between 2007 to 2017 were included. Searching backward allowed for older publications to be included.

Setting: Several research fields not relevant for this study were excluded (e.g., agriculture, microbiology and nursing.)

The above practical screens reduced the search results to 93 articles.

The authors went through title, keywords and abstract of the 93 articles to determine their relevance to the original research question. After the relevancy check, there were 8 accessible relevant papers. Three additional articles were identified from a backwards search (the forward search did not bring any new articles to the review), thus the search resulted in 11 articles for the analysis (Table 2).

A matrix for analysing and categorizing the articles were made and included: reliability, research field, aim, knowledge transfer tools, stakeholders, stage, aspect of sustainability, property type, research method, data type, theoretical framework, and landmark articles.

Table 2: List of reviewed articles

No.	Year	Search strategy	Author(s)	Country/Region	Journal
1	2017	Key word search	Chew et al.	Singapore	Facilities
2	2015	Key word search	Ganisen et. al.	Malaysia/India	Jurnal Teknologi
3	2015	Backwards	Göçer et al.	Turkey/US	Building and Environment
4	2013	Key word search	Meng	UK	Journal of Performance of Constructed Facilities
5	2012	Key word search	Jensen	Denmark	Architectural Engineering and Design Management
6	2012	Key word search	Menezes et al.	UK	Applied Energy
7	2011	Key word search	Chandra and Loosemore	Australia/Indonesia	Construction Management and Economics
8	2010	Backwards	Alhaji and Hassanain	Saudi Arabia	The Built & Human Environment Review
9	2009	Key word search	Jensen	Denmark	Architectural Engineering and Design Management,
10	2007	Key word search	Richardson and Lynes	Canada	International Journal of Sustainability in Higher Education
11	2003	Backwards	Erdener	US	Journal of Performance of Constructed Facilities

3. FINDINGS

Table 2 is a short list of the 11 articles, supplemented by Appendix A, providing a brief presentation of the articles and their main findings. Table 3 shows the tools identified within the 11 articles.

The topic is covered by journals representing a wide range of research fields, and only two journals are represented by more than one article (Table 2). This allows an analysis of the topic from various research fields and perspectives. A regional screen was not applied to the search, and the articles originate from various regions (table 2): UK (two articles), Denmark (two articles), Singapore, Malaysia/India, Turkey and US, Australia/Indonesia, Saudi Arabia, Canada and US.

The theoretical frameworks used in the articles can be divided into three categories, along a continuum. At one side is what we categorize as the socio-idealists and at the other side is the technical-idealist. In the middle we find frameworks of Facilities Management (FM) and Construction Management (CM) that borrow theories from both side.

Chandra and Loosemore (2011) is the purest example of the socio-idealists. One of several causes for difficulties in building design is described as follows: “A new hospital project becomes a challenging arena where all the inherent tensions that exist in the health sector are acted out”, and consequently, the project team must “work within this highly emotive

environment and within subtle, existing and often assumed power structures (...)"'. Having this as a starting point, Chandra & Loosemore uses frameworks and terms from psychology, organizational theory, cultural theory and knowledge management. Based on qualitative data, they give general suggestions for changes in the briefing stage. They suggest creating opportunities for constructive conflicts and encourage a briefing process with the end users in a leading role.

On the opposite end of the spectrum, Menezes et al. (2012) use quantitative data to propose a technical solution to bridge the performance gap. By describing the challenges of the design team they state: "Currently, there is a significant lack of information concerning the actual energy performance of our existing building stock." As Menezes et al. (2012) do not identify the same causes of the problem as Chandra and Loosemore (2011), their research is based on different theories. Menezes et al. use a framework of engineering, particularly the field of energy calculations. Changes to Post Occupancy Evaluation (POE), which, to some degree, is already implemented in the building industry, are suggested to give data that is far more accurate than today, leading to more precise predictions of future building's actual performance.

The majority of the articles are between these two presented categories, and focuses mainly on theory of CM, FM or both, borrowing theories from socio-idealists and technical-idealists. There is a tendency that the more the research leans to the socio-idealistic side, the less specific the recommendations are, and likewise, the more the research has a technical approach, the more specific the recommendations are.

Meng (2013) is an example of research of CM and FM, borrowing mainly from the socio-idealist fields. Meng (2013) presents a qualitative study including a literature review and interviews from more than 30 experts, leading to an identification of barriers to early FM involvement in design. Suggestions to overcome these barriers include "more attention to FM role" and "dialogue and good communication". This gives a thorough understanding of the barriers and underlying human mechanism, and points in a certain direction for solutions. However, it then leaves it up to the practitioners to sort out how to do in practice.

Two articles in the review represent Jensen, and the articles place themselves between the socio-idealist and technical-idealist. Based on literature review, case studies, a larger research project, and his own experience, Jensen (2009; 2012) provides a methodology for knowledge transfer in building projects. Using a theoretical framework of knowledge management, he lists a number of tools to enable knowledge transfer in a building project, including Commissioning, Projects Reviews, and Design, Build and Operate. These suggestions are on the technical-idealistic side and go beyond pointing a direction, as they are solutions that can be adopted by the building client. On the socio-idealistic side, he uses the example of the poor result of Danish regulation on the use of Life Cycle Cost (LCC) in public building projects, suggesting that "awareness" can be a more effective tool than "regulation", and furthermore he emphasises that the building client must take leadership of implementing initiatives to transfer knowledge from operation to design.

Göçer et al. (2015) is an example of research of CM, borrowing mainly from the technical-idealistic side. Göçer suggests, based on previous studies, that the feedback method POE should be further developed regarding the stages included as well as the methods and data used. They find an extended use of BIM (Building Information Modelling), including spatial

mapping, suitable to enable knowledge transfer from operation to design, bringing the predictions closer to actual building performance.

In addition to the differences in how concrete the recommendations of the articles are, there is also a difference in the approach to the problem. While the majority of the articles are concerned with how building performance can increase aligning of expectation and reality, two articles focus on getting the predictions corrected to align expectations and reality. In other words, it becomes a question of whether the aim of the recommendations in the article are to raise the performance or to lower the expectations. While none of the articles explicitly recommends lowering performance targets, there is nevertheless a tendency, that the more technical the framework used, the more the focus shifts towards correcting the calculations, rather than increasing performance. Correcting the calculation is, off course, expected to predict a lack of performance as early as possible, allowing the design team to make changes to the design, and leading, in the end, to higher performance.

The tools identified in the review are presented in Table 3. The term 'tool' is used on all the practical recommendations on optimizing transfer of operational knowledge to design. Not all of the articles are dealing with the topic in such a precise manner. For instance, Richardson and Lynes (2007) are concerned with how decisions on more green buildings on a university campus can be increased by including FM knowledge in decision-making. Nevertheless, the recommendations are compiled to provide an overview of the identified tools. Vague recommendations such as "more attention to FM", "good communication" (Meng 2013) and "increase transparency and communication" (Richardson & Lynes 2007) are left out as they are not identified as tools by the authors. Some tools have slightly different names in the articles, and with the risk of leaving out important differences, they have been put together with very similar tools to make a list of the main tools found.

Table 3: List of the identified tools.

Tools
a) Green maintainability protocol (Chew 2017)
b) LCC (Chew e2017, Meng 2013, Jensen 2009, Jensen 2012)
c) Financial forecast/FM budgeting in the design stage (Ganisen et al. 2015, Jensen 2009)
d) List of environmental variables to consider in design stage (Ganisen et al. 2015)
e) POE (Göçer et al. 2015, Menezes et al. 2012, Alhaji Mohammed & Hassanain 2010)
f) PPP (Meng 2013, Jensen 2012), including PFI (Meng 2011)
g) Continues Commissioning (Jensen 2012)
h) Continuous briefing (Jensen 2009 and 2012)
i) Detailed briefing, including guidelines, checklists, databases (Jensen 2009 and 2012),
j) CAFM (Jensen 2009)
k) Digital handover (Jensen 2009)
l) Project reviews (Jensen 2009 and 2012, Alhaji Mohammed & Hassanain 2010)
m) Regulation (Jensen 2009 and 2012)
n) Design, build and Operate (Jensen 2009 and 2012)
o) Contractor responsible for O&M (Jensen 2012)
p) Technical Due Diligence (Jensen 2012)

- | |
|--|
| <ul style="list-style-type: none">q) Building client guidelines and measureable quantitate targets (policy) (Richardson & Lynes 2007)r) Briefly mentioned: LEED (Chew et. al. 2017, Göçer et al. 2015)s) Briefly mentioned: BREEAM (Chew et al. 2017)t) Briefly mentioned: Soft Landings (as a route to the use of POE) (Göçer et al. 2015) |
|--|

4. DISCUSSION

Surprisingly, the articles seldomly mention certification schemes like LEED, BREEAM and DGNB (Chew 2017, Göçer et al. 2015), even though these schemes receive a lot of attention in practice. Soft Landings and commissioning are also discussed little within the articles (Göçer et al. 2015, Jensen 2012). It indicates that these concepts are not recognised and researched as tools for knowledge transfer. This is problematic, because important issues relating to knowledge transfer may then not be considered.

Several of the articles describe the contributions of FM to building projects. Alhaji Mohammed & Hassanain (2010) describe a very comprehensive role, giving FM a coordinating and approving role. Ganisen et al. (2015) support this comprehensive role: “During design phase Facility manager can provide accurate information on long term operational cost, introduce feasible design for building facilities, and guide with construction alternatives (...)”. Further research is needed to better understand the skills and competences FM personal should obtain to fulfil these increasing roles in building projects. In addition to that, it would be of great interest to investigate if the Facility Managers currently possess these skills, and if not; what is needed before the extended role of FM in building design is even possible.

Jensen (2009, 2012) highlights the building client as an important stakeholder when it comes to ensuring knowledge transfer. Facilities Management are, by many suggested to be able to provide great insight to new building projects (Jensen 2009 and 2012, Chew 2017, Meng 2013), and also the users are suggested to play a leading role (Chandra and Loosemore 2011). Both FM and the building client are referred to as a person or a unit. In reality, both FM and the building client, as well as the users, may be an entire organization and the necessary knowledge can be spread on sometimes hundreds of persons. Consequently, this paper suggests that future research investigates how FM as an organization can fulfil this important role in the knowledge transfer in an effective and valuable manner.

Many fields have potential to shed light on the problem of insufficient knowledge transfer from building operation to design. Therefore, new insights may be gained from studying other industries for inspiration for practical recommendations. This includes industries that have succeeded in knowledge communication between different cultures and industries experienced with knowledge management. Our next step in researching the insufficient transfer of knowledge in building projects includes comparative case studies of different industries.

5. CONCLUSION

There are currently two opposite trends in the research of knowledge transfer from building operation to design. On one hand, the socio-idealists looking at cultural and organizational theories for answers, and on the other hand, the technical-idealists looking at rational engineering frameworks for answers. The paper identifies a gap between the two, as there are

none or only very few practical directions to how strong leadership, constructive conflicts, etc., can be carried out in a design process, and opposite; none or only few directions on how for instance proper communication can be ensured when using tools like POE, project review etc. Based on that, this paper recommends, that further research should aim to make the recommendation of the socio-idealists instrumental, and include such recommendations in the identified tools like projects reviews, POE, commissioning etc.

A list of available tools has been gathered from the reviewed literature, confirming that a number of tools have already been developed and, to various degree, implemented in the building industry. Unfortunately, there are, as described in discussion, reasons to believe that some tools to ensure knowledge transfer are absent from the list. Apparently, they are not described as methods to enable knowledge transfer, and will consequently not appear in the search result for this review. Furthermore, the list lacks input from the socio-idealists, as their recommendations are identified as “awareness” rather than tools.

Our overall critique of the current theory of knowledge transfer from building operation to design is that studies in the literature generally underestimate the complexity of the problem. There is currently a lack of interdisciplinary studies that combine theories of organization, communication and knowledge management with theories of FM and CM that lead to practical directions. Therefore, the authors recommend further research to seek to combine the two opposite trends and turning ‘awareness’ into practical directions for the benefit of building clients, design teams, facility managers, building users, and the environment.

6. REFERENCES

- Alhaji Mohammed, M. and Hassanain, M.A., 2010, *Towards Improvement in Facilities Operation and Maintenance through Feedback to the Design Team*, The Built & Human Environment Review, Volume 3, 2010 72.
- Chandra, V. and Loosemore, M., 2011, *Communicating about organizational culture in the briefing process: Case study of a hospital project*, Construction Management and Economics, 29(3), 223-231. doi:10.1080/01446193.2010.521756.
- Chew, M. Y. L., Conejos, S., and Asmone, A. S., 2017, *Developing a research framework for the green maintainability of buildings*. Facilities, 35(1-2), 39-63. doi:10.1108/F-08-2015-0059.
- Due, P.H., Stephensen, P., 2012, *POKI – A Management Tool for the implementation of FM know-how in Construction Project*. In: Jensen, P.A. and Nielsen, S.B. (Eds.): Facilities Management Research in the Nordic Countries – Past, Present and Future. Centre for Facilities Management - Realdania Research, DTU Management Engineering, and Polyteknisk Forlag.
- Erdener, E., 2003, *Linking Programming and Design with Facilities Management*, Journal of performance of constructed facilities, feb 2003.
- Fink, A., 2005, *Conducting research literature reviews - From internet to paper*, book, Sage Publications, ISBN: 1-4129-0904-X.
- Ganisen, S., Jawahar Nesan, L., Mohammad, I. S., Mohammed, A. H. and Kanniyapan, G., 2015, *Facility management variables that influence sustainability of building facilities*, Jurnal Teknologi, 75(10), 27-38. doi:10.11113/jt.v75.5270.
- Göçer, Ö., Hua, Y. and Göçer, K., 2015, *Completing the missing link in building design process: Enhancing post-occupancy evaluation method for effective feedback for building performance*, Building and Environment, Springer-Verlag London 2015.
- Hansen A. P., Damgaard T., (2012), *Communities of Practice as a Learning Challenge in Construction Projects – How FM knowledge can be integrated in the learning processes*. In: Jensen, P.A. and Nielsen, S.B. (Eds.): Facilities Management Research in the Nordic Countries – Past, Present and Future. Centre for Facilities Management - Realdania Research, DTU Management Engineering, and Polyteknisk Forlag.
- Hart, Chris, 1998, *Doing a literature review – Releasing the social science research imagination*, book, Sage Publications. ISBN: 0 7619 5974 2.

- Jensen, P. A., 2009, *Design integration of facilities management: A challenge of knowledge transfer*. Architectural Engineering and Design Management, 5(3), 124-135. doi:10.3763/aedm.2009.0101.
- Jensen, P. A., 2012, *Knowledge transfer from facilities management to building projects: A typology of transfer mechanisms*. Architectural Engineering and Design Management, 8(3), 170-179. doi:10.1080/17452007.2012.669131.
- Lê M.A.T. and Brønn C., 2007, *Linking experience and learning: Application to multi-project building environments*. Engineering, Construction and Architectural Management, Vol. 14 No.2, pp 150-163, Emerald Group Publishing.
- Menezes, A. C., Cripps, A., Bouchlaghem, D., and Buswell, R., 2012, *Predicted vs. actual energy performance of non-domestic buildings: Using post-occupancy evaluation data to reduce the performance gap*. Applied Energy, 97, 355-364. doi:10.1016/j.apenergy.2011.11.075.
- Meng, X., 2013, *Involvement of facilities management specialists in building design: United kingdom experience*. Journal of Performance of Constructed Facilities, 27(5), 500-507. doi:10.1061/(ASCE)CF.1943-5509.0000343.
- Okoli, C., and Schabram, K., 2010, *A Guide to Conducting a Systematic Literature Review of Information Systems Research*, Sprouts: Working Papers on Information Systems, 10(26). <http://sprouts.aisnet.org/10-26>
- Ornetzeder, M., Wicher, M. and Suschek-Berger, J., 2016, *User satisfaction and well-being in energy efficient office buildings: Evidence from cutting-edge projects in Austria*, Energy and Buildings, No. 118, pp. 18–26
- Richardson, G. R. A., and Lynes, J. K., 2007, *Institutional motivations and barriers to the construction of green buildings on campus: A case study of the University of Waterloo, Ontario*. International Journal of Sustainability in Higher Education, 8(3), 339-354. doi:10.1108/14676370710817183.
- Sunikka-Blank M. and Galvin, R., 2012, *Introducing the prebound effect: the gap between performance and actual energy consumption*, Building Research & Information, 40:3, 260-273.
- Way M., and Bordass B., 2005, *Making feedback and post occupancy evaluation routine 2: Soft landing – involving design and building teams in improving performance*, Building Research and Information, 33:4, 353-360.
- Webster, J. and Watson R.T., 2002, *Analyzing the past to prepare for the future: Writing a literature review*, MIS Quarterly Vol. 26 No. 2, pp. xiii-xxiii/June 2002.

Appendix A: Brief description of the 11 reviewed articles, published 2003- 2017.

Author(s)	Title of the article	Brief description
Chew, M. Y. L. et al.	Developing a research framework for the green maintainability of buildings.	Based on a comprehensive study of 41 articles, Chew concludes that there is little research on the maintainability of green building and introduces the concept of 'green maintainability'. Chew states, that: "Researchers have emphasized the main causes that lead to building operations and maintenance problems are faulty design and maintenance -related defects". Chew presents the idea of a green maintainability protocol as a tool to consider the maintainability of green buildings at the design stage.
Ganisen, S.et. al.	Facility management variables that influence sustainability of building facilities.	A comprehensive literature review leads to the identification of a large set of FM criteria that influences sustainability in buildings. The criteria is divided in 7 categories and suggestions on FM contributions are provided. Examples of categories are O&M, Financial Management (including LCA), Environmental management and, health and safety management.
Özgür G. et al.	Completing the missing link in building design process: Enhancing post-occupancy evaluation method for effective feedback for building performance	By reviewing improvements made on the existing concept of POE, this article sets out 'a new vision for how future post-occupancy evaluation can close the building performance feedback loop (...)'. Integrating the use of BIM and GIS, and establishing a communication platform is suggested to improve POE and increase the share of quantitative data. According to the author, POE has the potential of bridging the performance gap by providing more realistic input to energy models. Özgür is also concerned with more realistic data to bridge the gap.
Meng, X.	Involvement of facilities management specialists in building design: United kingdom experience.	This study investigates 'early involvement of FM' through 31 expert interviews with industrial practitioners. Conclusions are, that despite the increasing acknowledgement of the benefits of early involvement of FM, resistance in practice is remains. Meng categorizes barriers in their relations to stakeholders, and makes suggestions to overcome the barriers, e.g. ' more attention to FM role', 'highlight of whole life costing' and, 'dialogue and good communication'.
Jensen, P. A.	Knowledge transfer from facilities management to building projects: A typology of transfer mechanisms.	In this article, Jensen presents a typology of mechanism of knowledge transfer from FM to building projects, suggesting that multiple strategies are needed simultaneously. 8 concepts are highlighted as serving different type of transfer, e.g. commissioning, project reviews, and regulation.
Menezes, A. C. et al.	Predicted vs. actual energy performance of non-domestic buildings: Using post-occupancy evaluation data to reduce the performance gap.	This article, based on case studies, argues, that the performance gap between predicted and actual energy performance, is best bridged by an extended use of POE. POE is recommended as an effective way of ensuring the needed, and currently missing, feedback from post occupancy to design. The purpose is to adjust the predictions to reality, rather than adjust reality to predictions.
Chandra, V., & Loosemore, M.	Communicating about organizational culture in the briefing process: Case study of a hospital project.	Based on case studies of 2 simultaneously briefing process (two parts of the same hospital building project), Chandra finds that the present briefing process is far too focused on physical needs and technical issues. Chandra argues that the building project will profit from a briefing process that encourage constructive conflicts providing deeper cultural learning. This acquires adequate time and skills, and can advantageously be led by the end users as 'custodians of cultural knowledge'.
Alhaji M. and Hassanain M.A.	Towards Improvement in Facilities Operation and Maintenance through Feedback to the Design Team.	In this article, definitions for the different stakeholders in current building design are listed and a new definition for FM in design is suggested giving FM a central and coordinating role within 'the integrated design team'. FM contribution and feedback to each part of the design team, together with approval of design by FM are key elements.
Jensen, P. A.	Design integration of facilities management: A challenge of knowledge transfer.	This article can be seen as a forerunner for the article by the same author published 3 years later also included in this review. The building client is giving the leading role to ensuring, that 'the considerations for operation and sustainability are taken seriously by the design team'. Codification of knowledge is one of four mechanism Jensen argues results in increase of transfer of knowledge. Jensen furthermore discusses the effectiveness of use of power in contrary to awareness and argues that competences of the FM personnel involved in design is important for several reasons.
Richardson, G. R. A., & Lynes, J. K.	Institutional motivations and barriers to the construction of green buildings on campus: A case study of the university of Waterloo, Ontario.	This Article study the barrier and motivations to the construction of green buildings, suggesting that four key ingredients are needed for successful green buildings. Based on 13 interviews and document analysis on one university Campus four ingredients related to decision making prior to design are defined: Strong leadership, quantitative sustainable targets, facilitation of collaboration, and increased communication.
Erdener, E.	Linking Programming and Design with Facilities Management.	Erdener suggest that programming provides great opportunity of linking different stakeholders in the building project, and suggest FM as a strategic resource and partner in the process. A modified framework for the construction management of a facility is

		presented, suggested to replace the present and well known framework of predesign, design, construction and post occupancy.
--	--	---

IMPLEMENTATION OF SMART DEVICES IN THE DOMINICAN REPUBLIC CONSTRUCTION INDUSTRY: AN EMPIRICAL STUDY

M. Silverio, S. Renukappa and S. Suresh

Faculty of Science and Engineering, University of Wolverhampton, Wulfruna Street, WV1 1LY, UK.

Email: suresh.renukappa@wlv.ac.uk

Abstract: The construction sector in the Dominican Republic is an important industry which contributes approximately 17.7% of the GDP. Recently, it has been the most significant economic activity in the country providing employment and economic growth. However, on a global scale, the construction sector is considered to have a high degree of decentralisation of information. The exchanged of information made possible by smart devices and the Internet of Things creates an opportunity to enhance the construction sector. This paper primarily reports on the empirical findings of an on-going research study, which is focused on increasing the sustainability of the construction industry via the implementation of smart devices. This paper encompasses the status of digitalisation in the construction sector of the Dominican Republic as well as implementations of smart devices and related technologies in the same industry. The findings are based on semi-structured interviews with fifteen professionals from nine construction organisations. The data analysis revealed a low level of digitalisation. Also, the main smart devices utilised in the construction industry of Dominican Republic are Smartphones and tablets. The paper concludes that smart devices increase efficiency in the construction industry of Dominican Republic by adding mobility, ubiquitous data access, and digitalisation of paperwork.

Keywords: Construction Industry, Digitalisation, Smart Devices, Sustainability

1. INTRODUCTION

According to the report on the Economy of the Dominican Republic (Central Bank of the Dominican Republic, 2016) on a national scale, the construction industry contributes to approximately 17.7% of the GDP and has had one of the highest economic relevance for twelve trimesters. This economic behaviour is due to the necessity of dwellings of low cost and execution of public and private projects focused on tourism, commerce and road work. Consequently, this industry has been the most significant economic activity in the country, providing employment and economic growth. On the other hand, on a global scale the construction sector is a fragmented sector where many stakeholders and parties need to work together to deliver a project successfully. Box (2014) states that this sector has the highest degree of decentralisation of information, highest mobility and highest external collaboration when compared with others four industries, namely: Software; manufacturing, finance; and media and entertainment. This behaviour affects the efficiency and sustainability of the industry, thus producing a decentralised collaboration ecosystem as can be seen in Figure 1.

Considering that smart devices enhance mobility and communication on any industry, and nowadays trends of sustainable construction show as necessary the implementation of the latest technologies to improve the construction sector. It seems appropriate that the exchanged of information made possible by smart devices and the Internet of Things (IoT) creates an opportunity to enhance the construction sector, thus increasing sustainability.

The Internet of Things (IoT) is a relatively recent paradigm that is rapidly gaining ground and acceptance in the scenario of wireless telecommunications. This concept is based on the

continuous presence of a diversity of objects which are connected to a network or other devices and can interact with each other to reach common goals (Giusto *et al.*, 2010). The main strength of the IoT is the high impact it will have on several aspects of everyday life and behaviour of potential users in both working and domestic fields. If well implemented in the field of Architecture Engineering and Construction (AEC) it represents a major step towards the integration of stakeholders via autonomous information exchange.

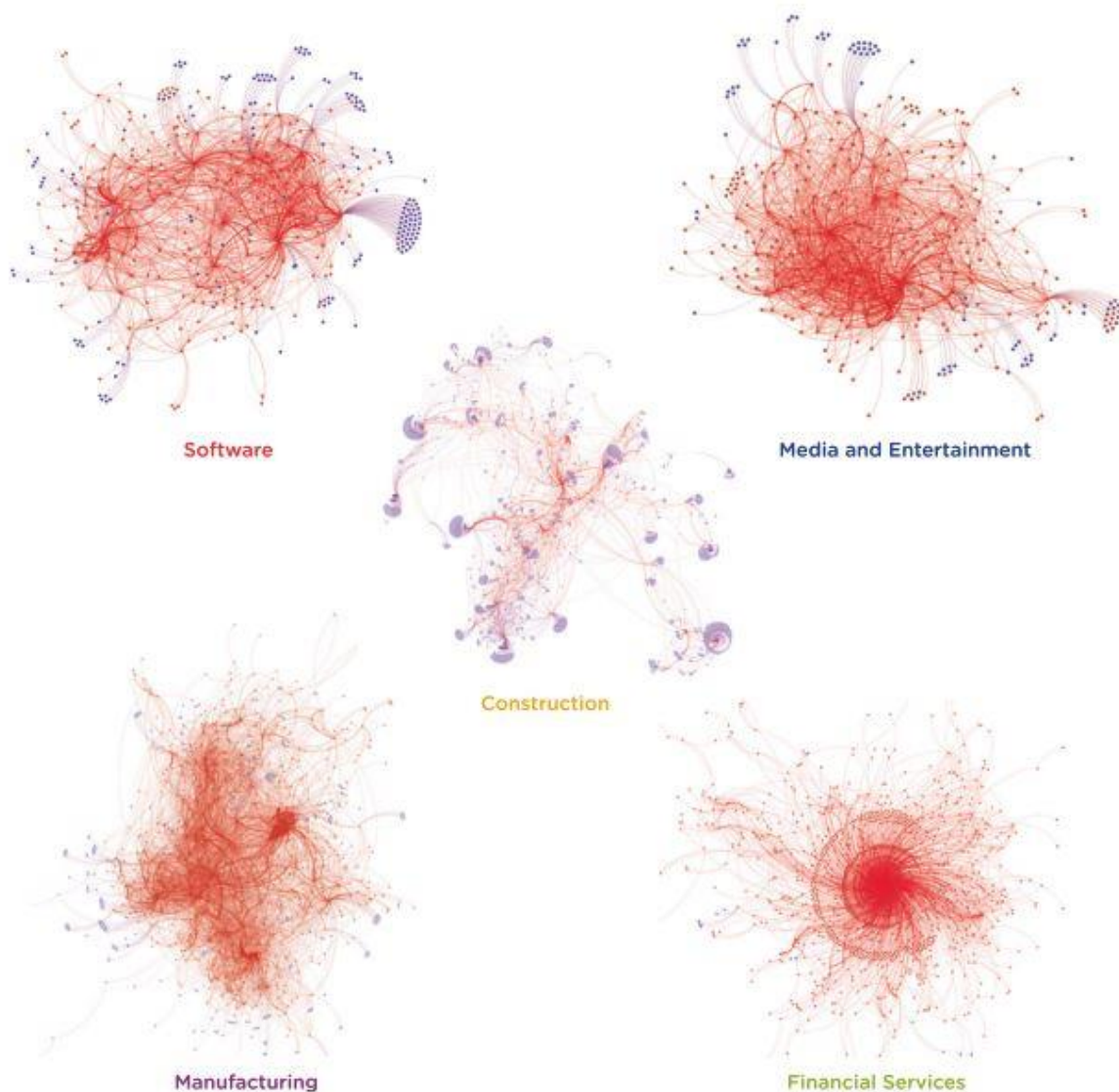

Figure 1: Collaboration graph between stakeholders of five industries (Box, 2014)

According to Atzori *et al.* (2010), the IoT has an enormous potential for developing a large number of applications in our society. By implementing this paradigm in the construction industry, regular objects would record data which can be used to build relevant metrics to users. The data obtained from the integration of the IoT with traditional construction processes can be used to enhanced construction projects, and subsequently, make the industry more sustainable, by enabling regular objects to communicate with each other and collect information from the surroundings where a wide range of autonomous applications can be deployed.

Smart devices are objects capable of communication and computation which range from simple sensor nodes to home appliances and smartphones. This paper considers smart devices as the objects present in the pervasive network of the IoT (Stojkoska et al., 2016). Some authors also use other terms for referring to smart devices, Azhar *et al.* (2015) use the terms “mobile tools”, “mobile technologies” and “mobile devices” for devices that allow workers to get instant access to project documents, plans and specifications.

Some of the main technologies associated with smart devices in the construction industry are Cloud Computing (CC), Augmented Reality (AR), Building Information Modelling (BIM), and Geographical Information System (GIS). The main idea behind each one of these technologies is the following:

- CC makes applications and data available remotely, providing ubiquitous data access to its users. In the construction industry, it shows benefits such as cost reduction, mobility, flexibility and ease of maintenance (Silverio *et al.*, 2017).
- AR represents a viable and efficient approach for combining virtual reality with the real world (Kamat *et al.*, 2010). AR augments user’s perception of a real-world entity by inserting relevant digital information into the real environment. Similarly, Chi et al. (2013) explain AR creates an environment where computer generated information is superimposed onto the user’s view of a real-world scene.
- BIM integrates a 3D model for display and a data set of properties to maintain. The implementation of BIM in construction projects can increase collaboration within project teams, improved profitability, reduced costs, better time management and improved customer/client relationships (Chong *et al.*, 2014).
- GIS is a system to capture, store, manipulate, analyse, manage and present all types of geographical data (Sweeney, 1999). A comprehensive review of the application of GIS in construction activities was performed by Bansal (2007), presenting solutions like subsurface profiling, construction cost estimation and quantity take-offs, materials layout at construction site, construction site layout, real-time schedule monitoring systems, route planning and topography visualisation.

Given the current scenario where the construction industry needs more centralisation of information, mobility, ubiquitous data access and communication between stakeholders; this paper aims at investigating the implementation of smart devices within the paradigm of IoT in the construction industry of the Dominican Republic, as part of a larger investigation on the same topic.

2. RESEARCH METHODOLOGY

This paper reports on the empirical findings of an on-going research study, which is focused on increasing the sustainability of the construction industry with the integration of a strategic framework for the implementation of smart devices. This paper addresses the status of digitalisation in the construction sector of the Dominican Republic; organisational structure of construction companies in the Dominican Republic; and the utilisations of smart devices and related technologies in the industry.

As an initial step, this article follows a systematic approach for reviewing compendium of literature to examine the background of this research and define the interview questions. The search for peer-reviewed journal articles has been done via databases, initially in chronological order. Subsequently, this allowed performing a literature review. A literature review is a systematic and reproducible approach for synthesising the existing body of published work generated by researchers or scholars (Fink, 1998). Due to the ever-increasing number of academic papers (Conferences, journals and books), literature reviews have become a usual and indispensable method for synthesising a specific research field (Teuteberg and Wittstruck, 2010).

As a pilot study and initial data collection a set of 15 semi-structured interviews were performed in the Dominican Republic, enquiring about: Digitalisation of construction, utilisation of smart devices in construction projects, drivers, barriers and critical factors for a successful implementation of smart devices. The sampling technique was critical case sampling; this is a type of purposive sampling technique that is particularly useful in exploratory research which allows establishing logical generalisations. Due to the qualitative nature of this research it was necessary to select critical companies that represent a variety of scenarios of the construction industry in the Dominican Republic.

The collected data was analysed using qualitative content analysis following the guidelines of White and Marsh (2006). The coding scheme was inductive and followed the initial questions of the study as a guide for the creation of themes. After grouping the data in themes, sub-themes were created inductively. This process was used to create a “big picture” of about the status of smart devices and Digitalisation in the Dominican Republic. Hence, the findings are shown as a narrative which describes the perception of the interviewed construction companies.

The findings are in Section 3 as follows: Section 3.1 discussed the organisational structure and creation of innovation in the construction industry of the Dominican Republic. Section 3.2 presents the status of digitalisation in the construction sector, whereas section 3.3 addresses the main utilisation of smart devices in the Dominican Republic construction industry. Section 4 discusses the conclusions of this paper and future work of this investigation.

3. RESULTS AND DISCUSSION

The results from the data analysis consist of: (1) an empirical organisational structure of the construction industry in the Dominican Republic, (2) the status of digitalisation in the same industry and (3) the main utilisations of smart devices in construction projects of this sector. The organisational structure of the construction sector shows the innovation cycle between the public and private sector as well as the structure within small, medium and large companies. The status of digitalisation in construction narrates the strategy and barriers of these companies to embed technology for becoming more digital based. Finally, the utilisation of smart devices is grouped into six categories which explain how professionals of the industry are using devices like tablets, smartphones and smart boards to enhance the processes of the industry.

3. 1 Organisational structure of the construction industry in the Dominican Republic

Figure 2 shows the interaction between private and public sector in the construction industry of the Dominican Republic as well as the organisational structure of small, medium and large companies. The public sector has the largest economic resources, consequently, it subcontracts the private sector for the partial or full development of projects. In the construction industry of the Dominican Republic, the public sector is known by not being innovative in comparison to the private sector. On the other hand, the large size companies on the private sector take more risks embedding new technologies into their project, if those technologies prove themselves to be cost and time-saving. Once the private sector has demonstrated a technology works in the industry, the public sector, driven by cost savings, embeds that technology into their ecosystem.

The organisational structure of medium and large size companies has a top management level which is formed by the decision makers (see Figure 2). This group consists of one or more individuals who oversee the company trajectory and the approval of new technologic initiatives, on a lower level, there is a middle management layer which is composed of the project managers of the company. These managers can implement low budget initiatives to create a case study that convinces the decision makers to adopt a full implementation of certain technology. The design and supervision team is composed of all the professionals in all the departments of the company (Architecture, engineering, finance, etc.) that design, administrate or supervise the project. This layer can try to innovate, but any innovation would be isolated unless the middle management team accepts it. The last layer is the execution workforce, which is composed of all the workers on the job site. The innovation on this layer is localised, and because of the social situation of the Dominican Republic, this layer is usually the one with less technological capability.

For small companies, the structure rotates around a project management team which is usually one person or an association of two or three professionals of the industry. This group subcontracts most of the services and depending on the company size and field of work they have a small design team.

3.2 Digitalisation of construction

The digitalisation of information of construction companies in the Dominican Republic varies depending on the company size, project size and leadership in the business. Larger companies are more likely to implement more software for digitalising Request for Information (RFI), whereas the decisive factor is the leadership shown by the decision makers.

On big sized companies, the organisational structure represents a significant role for the introduction of new technologies. Companies with a middle management line as in Figure 2 can introduce initiatives for the implementation of new technologies. As an example, an initial stage of BIM was implemented for a medium sized project, with the main purpose of proving to the top line management (decision makers) the benefits from the implementation of BIM.

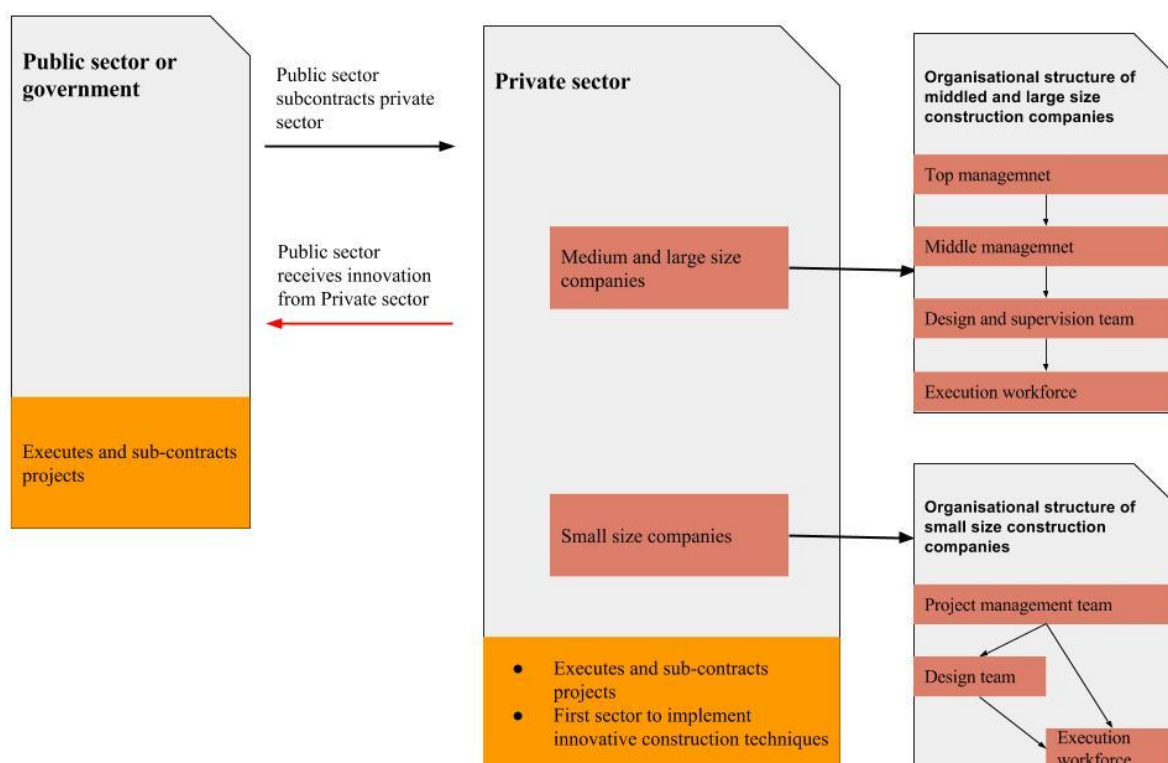

Figure 2: Organisational structure and innovation exchange in the Dominican Republic construction industry

The main barriers for the digitalisation of construction are: Cultural issues and lack of innovation

- **Cultural issues:** This barrier arises from the tradition in the Dominican Republic’s construction industry of printed documentation for project approvals, this means that even if private companies are willing to submit project’s documentation digitally, some of the stakeholders of the project, usually the government will require a printed copy.
- **Lack of innovation:** The general perception of construction companies is that “there is a long road ahead” and there is still much work to be done for businesses to manage all their documentation on a digital format. Decision makers are reluctant to step forward into a full digitalisation of the industry mainly because of lack of case studies and guidelines.

Despite, all the barriers, large companies in the private sector showed awareness of where the industry is moving to, as can be seen in the following quote extracted from one of the semi-structured interviews:

“There is loads, loads of paperwork, more than I thought when I came back from my master, the directors of the company are aware of it and they are aware of where the industry is moving to. That there are few technologies applied to the industry, but many alternatives are being created. So right now, the industry is in the process of adapting to those new emerging technologies oriented to construction.”

3.3 Utilisation of smart devices in construction projects in the Dominican Republic

The results about the utilisation of smart devices have been grouped into six categories namely: Information exchange, geolocation, project management, material management, measurement, media management.

Information exchange: Exchange of information through smart devices through chats, emails, management apps, and calls. The exchanged media is photos, reports, drawings, construction manuals, calculus sheets and punch lists.

Geolocation: Utilisation of geolocation on road projects.

Measurement: Integration of smart devices into pre-existing equipment to track information and obtain metrics such as terrain compaction level and volume of terrain movement.

Project management: Creation of events and reminders for mobile Apps. Coordination of meetings through mobile Apps. Monitoring of security cameras in real time. Utilisation of smart board for information exchange during meetings.

Material management: Elaboration of inventory and material requests. Follow-up of material through chat.

Media management: Implementation of smart devices for capturing, editing and storing information such as drawings, punch list, calculus sheets, construction manuals, presentations, photos, reports.

4. CONCLUSIONS AND FUTURE WORK

Innovation in the construction industry in the Dominican Republic relies on the private sector, at the same time the private sector relies on big projects to make innovations; such projects usually come from the public sector. This interaction between sectors is how innovation is created and assimilated in the country.

The factors that affect the digitalisation of information are company size, project size and leadership. Whether a company has the will to become more digital-based, there is a big cultural barrier in the Dominican Republic society, which is the requirement from stakeholders of printed copies of the project documentation. Nevertheless, although currently a full digitalisation is not possible, companies can improve their processes by adopting smart devices and their related technologies. Large companies have shown awareness of the direction the industry is taking towards a more digitalised work environment.

Smart devices have proven their value to the construction industry by adding mobility and ubiquitous data access to construction projects. In addition, smart devices can be installed to construction equipment to obtain relevant data about construction activities.

Future work of this research includes analysing the drivers, barriers and Critical factors for a successful implementation of smart devices. In addition, A new set of interviews will be done in the United Kingdom which will be used to compare similar factors in a different socio-

economic scenario, subsequently this data could be used for the development of guidelines for the integration of smart devices in the AEC sector.

5. REFERENCES

- Atzori, L., Iera, A. and Morabito, G., 2010. The internet of things: A survey. *Computer networks*, **54**(15), pp. 2787-2805.
- Azhar, S. and Cox, A.J., 2015. Impact of Mobile Tools and Technologies on Jobsite Operations. *51st ASC Annual International Conference Proceedings*, .
- BansaL, V.K., 2007. Potential of GIS to find solutions to space related problems in construction industry. *World Academy of Science, Engineering and Technology*, **8**, pp. 307-310.
- Box, I., 2014-last update, The Information Economy: A study of Five Industries. Available: <https://www.box.com/blog/mapping-the-information-economy-a-tale-of-five-industries/>.
- Central Bank Of The Dominican Republic, 2016. *Economy on Dominican Republic's economy January-June 2016*. Dominican Republic: .
- Chi, H., Kang, S. and Wang, X., 2013. Research trends and opportunities of augmented reality applications in architecture, engineering, and construction. *Automation in Construction*, **33**(0), pp. 116-122.
- Chong, H., Wong, J.S. and Wang, X., 2014. An explanatory case study on cloud computing applications in the built environment. *Automation in Construction*, **44**, pp. 152-162.
- Fink, A., 1998. *Conducting Research Literature Reviews: From Paper to the Internet*. 1st edn. Los Angeles, United States: Thousand Oaks : Sage Publications.
- Giusto, D., Iera, A., Morabito, G. and Atzori, L., 2010. *The internet of things: 20th Tyrrhenian workshop on digital communications*. Springer Science & Business Media.
- Kamat, V.R., Martinez, J.C., Fischer, M., Golparvar-Fard, M., Pena-Mora, F. and Savarese, S., 2010. Research in visualization techniques for field construction. *Journal of Construction Engineering and Management*, **137**(10), pp. 853-862.
- Silverio, M., Renukappa, S., Suresh, S. and Donastorg, A., 2017. Mobile Computing in the Construction Industry: Main Challenges and Solutions. *Leadership, Innovation and Entrepreneurship as Driving Forces of the Global Economy*. Springer, pp. 85-99.
- Stojkoska, B.L.R. and Trivodaliev, K.V., 2017. A review of Internet of Things for smart home: Challenges and solutions. *Journal of Cleaner Production*, **140**, pp. 1454-1464.
- Sweeney, M.W., 1999. Geographic information systems. *Water Environment Research*, **71**(5), pp. 551-556.
- Teuteberg, F. and Wittstruck, D., 2010. A systematic review of sustainable supply chain management. *Multikonferenz Wirtschaftsinformatik 2010*, , pp. 203.
- White, M.D. and Marsh, E.E., 2006. Content analysis: A flexible methodology. *Library trends*, **55**(1), pp. 22-45.

KNOWLEDGE INTEGRATION FRAMEWORK FOR TRADITIONAL CONSTRUCTION PROCUREMENT SYSTEM

M.Takhtravanchi and C.Pathirage

School of the Built Environment, Salford University, M5 4WT, UK

Email: M.Takhtravanchi@edu.salford.ac.uk

Abstract: In the construction industry, project knowledge mostly resides in the minds of project members. The successful completion of a project requires a rigorous understanding of each stage of project life cycle that can be enhanced through integrating knowledge between project members, in terms of capturing and sharing knowledge between project members, and transferring it to the next project. Due to the temporary and unique nature of construction projects, project members leave for another one whilst a project is completed. Therefore, poor integration of knowledge across construction projects will lead to a considerable amount of knowledge loss. This issue is more prominent in construction projects undertaken through the traditional procurement system, as this system encourages fragmentation rather than integration. Accordingly, poor integration of knowledge exists between the design and construction phases. This paper aims to propose a framework on how to integrate tacit knowledge in terms of capturing, sharing, and transferring within a construction project undertaken through the traditional procurement system. The framework consists of three sections: factors (challenges and critical success factors), means (techniques and technologies) and process. This framework was structured by a literature review, experts' survey, and case study, being afterwards evaluated through experts survey composed of construction managers and professionals, resulting in an enhanced version including a guidelines for knowledge integration process. This framework covers the social dimension of knowledge and enables stakeholders to be aware of the key challenges and techniques for integrating tacit knowledge in the construction industry.

Keywords: Construction Industry, Knowledge Integration, Traditional Procurement System

1. INTRODUCTION

Knowledge can be defined as higher level of abstraction that resides in people's minds which includes perception, skills, training, common sense, and experiences (Awad & Ghaziri, 2004 in Faucher et al., 2008). It is categorised either as tacit or explicit. Tacit knowledge is experience and skills which are available in mind of individuals and hard to capture and distribute. Explicit knowledge refers to information that can be codified, stored and distributed in certain media. Implicit knowledge is another dimension of tacit knowledge which is about process of doing something (knowing-how) and act as a potential bridge between tacit and explicit knowledge. In this research the implicit component of tacit knowledge is considered.

Knowledge empirically proven as a vital resource that can create added wealth for organisations. Its value is it comprises lessons learned, creative processes, best practices, and problem-solving methods which are hard to be imitated by competitors (Renzel, 2008). Therefore, organisations will benefit from this valuable asset, if it is managed effectively. Knowledge management [KM] is essential for organisations, specifically in project-based industries like construction. It can bring competitive advantage and improvement in project performance of construction organisations. KM is a wide concept that includes various processes among which three main ones are: capturing, sharing and transferring. Using these three process, together, can integrate knowledge within project-based organisations which are tend to embark on rework thereby often repeating the same mistakes again. In other words,

knowledge integration [KI] is the process of capturing and sharing knowledge during a project and transfers it to the next project. This will result in reusing knowledge, reducing project time, and improving its quality and performance.

2. KNOWLEDGE INTEGRATION IN CONSTRUCTION INDUSTRY

The KI procedure is critical to project performance (Nonaka & Takeuchi, 1995), especially in a project-based industry like construction. The importance of KI has attracted discussions in both academia and industry. As knowledge is the most value-added input and output of projects, then the study of KI between teamwork within project and across projects will provide a meaningful insight for stakeholders and academics that enable them to improve further the performance and competitiveness of the industry. From the working perspective, KI is defined as the process that leads to a practical solution by contributing the expertise and knowledge of all involved parties. KI in this study is the process of capturing, sharing, and transferring knowledge within a construction project undertaken through the Traditional Procurement System (TPS).

In the construction industry, project knowledge mostly resides in minds of project members and is, frequently, not captured and transferred across projects in order to be used in future (Shokri and Chileshe, 2014). This means that knowledge is not integrated structurally between projects and the team members in those projects. The nature of construction projects is temporary which means project members leave a project for another one once a project is completed. Therefore, much knowledge that is gained by project members will be lost and dispersed if it is not structurally captured and shared at the end of a project. Researchers believe that the construction industry will lose its skilled and knowledgeable workforce because there is no effective strategy to integrate knowledge across projects and between team members (Kanapecikiene et al., 2010). In other words, the construction industry suffers from a lack of KI between its phases (Love et al., 2013; Zhu et al., 2014), especially in the traditional procurement system (In Construction 2025 report, 2013). This issue is more common in a construction project undertaken through the TPS because the nature of this system is based on the separation of design and construction process (Aziz et al, 2014).

According to Masterman (2002), the traditional procurement system suffers from a lack of management expertise. Due to the nature of the system, the period of the design and construction phases are lengthy. Therefore, good communication needs to exist between all members of a project. Secondly, the traditional procurement system suffers from a lack of buildability during the design and construction phases. Designers are not motivated and well experienced enough to manage the construction work and the cost and time of a project effectively. There is no ethos of sharing knowledge between the design and construction phases in a traditional procurement system (Aziz et al., 2012; Love et al., 2013). Additionally, the people involved in the construction phase are unable to contribute to the design of a project until it is too late.

Cheng (2012) highlighted that different techniques are used to capture knowledge and for sharing important information and knowledge that assists in solving some intractable problems in the different phases of a construction project; the amount of knowledge loss in later phases is great and ignoring it would be detrimental to project performance. Therefore, there is a need to motivate project members in both the design and construction phases to use and share their experiences in order to improve project performance. Within this context, failure to integrate

knowledge will result in spending more time, in incurring greater costs and in increasing the possibility of “reinventing the wheel”.

3. METHODOLOGY

The research aims to propose a framework on how to integrate tacit knowledge in terms of capturing, sharing, and transferring within a construction project undertaken through the traditional procurement system. On the basis of available studies on KI within the industry investigated, a methodology based on multiple case studies is followed to reach the aforementioned aim. Furthermore, an experts’ opinion survey, including construction managers and professionals, is used to evaluate the developed framework. This resulted in an enhanced version of framework including a guideline for KI process.

The first stage of this research included a thorough study of the relevant literature which aimed to understand the concept of KI, its challenges and approaches in traditional construction projects. Accordingly, multiple case studies are selected that includes two case studies to reflect the building sector within construction industry. The projects were complex, large and costs over £5m. The selected case studies differ in that one of them is completed project and the other is an ongoing project at construction phase. As most of the problems and errors occurred in project lifecycle are related to designing phase, the cases were selected from same organisation involved at designing phase in order to analyse and compare the process of KI. The outcomes obtained from the case studies allow drawing some conclusions on the challenges, techniques and the process of KI adopted by designing organisations. Finally, an online open-end questionnaire was conducted to collect experts’ opinion on the developed framework. The questionnaire was distributed among 180 experts. The discussion on the findings from online survey is not included in this paper and will be discussed in the future publications.

The main research tool was semi-structured interviews where a number of open-ended questions were used in order to identify to key challenges and approaches (techniques and technologies) of KI. The questions allowed respondents to give their views based on their own experiences concerning the challenges within traditional construction projects and the factors that affect KI within this type of procurement. The answers produced considerable information about the respondents’ views on the current challenges within the traditional procurement system in terms of KI.

The interviewees’ profile is illustrated in Table I. The interviews lasted one hour and some were extended as the interviewees were very open and eager to talk about and discuss their experiences. Furthermore, all interviews were audio-recorded – with interviewees’ permission – then transcribed and entered into NVivo software. Thematic analysis was undertaken of the transcripts with a particular focus on the challenges and approaches of KI in terms of capturing, sharing and transferring knowledge. The analysis of both case studies were synthesised and compared with findings from the available studies in order to develop the KI framework.

Table I: Interviewees profile

Interviewee	Case Study (CS)	Total Experience	
Project manager	CS1, CS2	25 years	
Architecture	CS1	13 years	
Site manager	CS1	18 years	
Engineer	CS1	11 years	
Architecture	CS2	6 years	
Site manager	CS2	35 years	
Engineer	CS2	16 years	

4. TACIT KNOWLEDGE INTEGRATION FRAMEWORK

The TKI framework has three main components which are interlinked together: KI Challenges, KI Means, and TKI process. The BIM technology is suggested in the TPS as a technology that can be used as a knowledge repository and facilitate the process of TKI. Therefore, the proposed framework (Figure 1) is based on considering using the BIM technology by construction organisations.

4.1 Challenges

Takhtravanchi and Pathirage (2016) identified 11 factors as challenges and barriers of TKI within the TPS. They concluded that three of them are the main challenges and the rest are the barriers that affect the process of TKI. The three main challenges are *Culture of Organisation*, *Contractual Barriers*, and *KM System (policies and strategies)*. It is concluded that 'KM System' is affected by 'Culture of Organisation' and 'Contractual Barriers'.

To successfully implement TKI within the traditional construction project, the project manager should consider the mentioned challenges and solve them by considering the CSFs. These challenges and CSFs affect the TKI process and should be considered by the project manager when establishing strategy and objectives for integrating knowledge. Furthermore, considering these challenges will enable project managers to choose an appropriate means for integrating tacit knowledge within the traditional construction project. In other words, resolving below issues which will influence the choice and usage of techniques and technologies which will further impact the TKI process.

- having an open environment for integrating knowledge (Culture of Organisation)
- having a clarification on the liability of project members for sharing knowledge between contractors (Contractual Boundaries)
- adopting proper policies and strategies for KM (Knowledge Management System) which includes:
 - adopting proper tools for TKI
 - improving awareness on the importance of TKI
 - building trust
 - incentivise project members for participation in TKI

- having clear definition of objectives
- designing sub-contractors use software that can be synchronised
- adopting two-stage process in the TPS

4.2 Means

‘KI means’ handles the content and richness of knowledge. Thus, it is important to choose appropriate techniques and technologies for integrating knowledge. Therefore, ‘Knowledge Integration Means’ directly prompts the TKI process forward. Project managers need to adopt appropriate means (techniques and technologies) for integrating knowledge. This is highly dependent on considering the challenges within the TPS due to the separation of the designing and construction phase in this system. The techniques and technologies for facilitating the process of TKI are: Lessons learned, Best practice, Post Project Review (PPR), Regular meetings, Communities of Practices (CoPs), BIM technology, and Information and Communication Technologies (ICT).

4.3 KI process

KI consists of three processes: capturing, sharing and transferring. As most of the problems occur during the project lifecycle are related to designing, the TKI process within the traditional construction project should mainly be implemented by the designing team. This process includes some stages which are explained below.

4.3.1 Stage One: project inception

To successfully integrate tacit knowledge in the traditional construction project, the project manager in the designing team must thoroughly understand and research the project in order to identify whether there has been a similar project run by their organisation in the past or not. If so, initially the related strategy for transferring knowledge should be established to retrieve the related project knowledge from the knowledge repository (refer to stages two, five and eight). Then the project manager should establish strategy and objectives for the knowledge capturing and sharing process (with respect to stage two).

4.3.2 Stage Two: establishing a strategy and objectives for TKI

Establishing a strategy for TKI is significantly influenced by KI challenges that enable the project members at designing phase to exploit their knowledge and learning capabilities. It includes the extent to which the project members are

- working in an open environment in terms of willingness to share knowledge, having mutual trust, and enough time to participate in TKI
- aware of the importance of TKI
- having a clear definition on their objectives

Furthermore, the project manager must have a clear view on the contract’s clauses in terms of knowing the liability of the project members for sharing knowledge at the different phases of

project. In other words, the project manager must know what type of knowledge and to what extent the knowledge can be shared between contractors. This will enable the project manager to select and use proper means for TKI in terms of capturing, sharing, and transferring knowledge.

4.3.3 Stage Three: implement appropriate means (techniques and technologies) for TKI – capturing

There are different ways to integrate knowledge (tacit and explicit). Project members need to be incentivised to participate in the TKI process. The project manager can elicit tacit knowledge from project members in the form of lessons learned, best practice, communities of practices, post project review (PPR), and regular meetings. Furthermore, technology has a direct impact on the TKI process, specifically in capturing process. ICT (Information and Communication Technology) like E-mail, video conferencing, and internet can be used by project members for not only capturing knowledge but also for sharing knowledge during the project lifecycle. In the TPS, the BIM technology can be used by the project manager at the designing phase, in order to enhance the TKI process.

4.3.4 Stage Four: filter knowledge

Each project creates new knowledge and project members can achieve new knowledge during a project lifecycle. Once it is captured, the knowledge repository tends to grow. When using the BIM technology as a repository, the captured knowledge (in form of either COBie or IFC files) is subject to review and value adding processes of filtering like indexing, abstracting, integrating, labelling and sorting. This filtering should be done by experts before adding the captured knowledge to the knowledge repository. In the TPS, the knowledge that is captured from the construction team also needs to go through filtering process.

4.3.5 Stage Five: knowledge repository

The BIM technology can be used as a knowledge repository within the TPS. Due to the nature of this system, it is suggested that the designing organisation holds the liability of this repository. This repository is a database that includes designing team information, project information, the knowledge that is gained from reports and meeting' minutes during designing phase, and the COBie and IFC files that are used by designing contractors.

4.3.6 Stage Six: knowledge sharing

As knowledge equals to power, if it is shared it will be multiplied. Therefore, the project manager should consider the power of knowledge sharing and incentivise project members to share their experiences and knowledge. With respect to stage two and three, once a strategy and objectives are established for the KI, the proper means can be used for sharing knowledge by project members at the designing phase. In the TPS, knowledge sharing should happen between the designing and construction phase. The knowledge sharing process can be facilitated by using a knowledge repository.

4.3.7 Stage Seven: knowledge update

Once the knowledge is shared, new knowledge will be created and project members can update their knowledge. This new knowledge can also be created and gained through the knowledge sharing process between the designing and construction phase. The new knowledge, with respect to stage four, is required to be reviewed and validated by experts before being put in the knowledge repository.

4.3.8 Stage Eight: knowledge transfer

With respect to stage one and two, if the designing organisation has done the similar project in the past, then the project manager should retrieve the related project knowledge from the knowledge repository. With respect to stage three and stage five, the BIM technology is suggested to be used as the knowledge repository. Therefore, the retrieval of the related project knowledge from repository means acquiring the related BIM model and then using and modifying it for the current project. The knowledge transfer process facilitates the project in terms of minimising the number of designing errors which will result in reducing the cost and time.

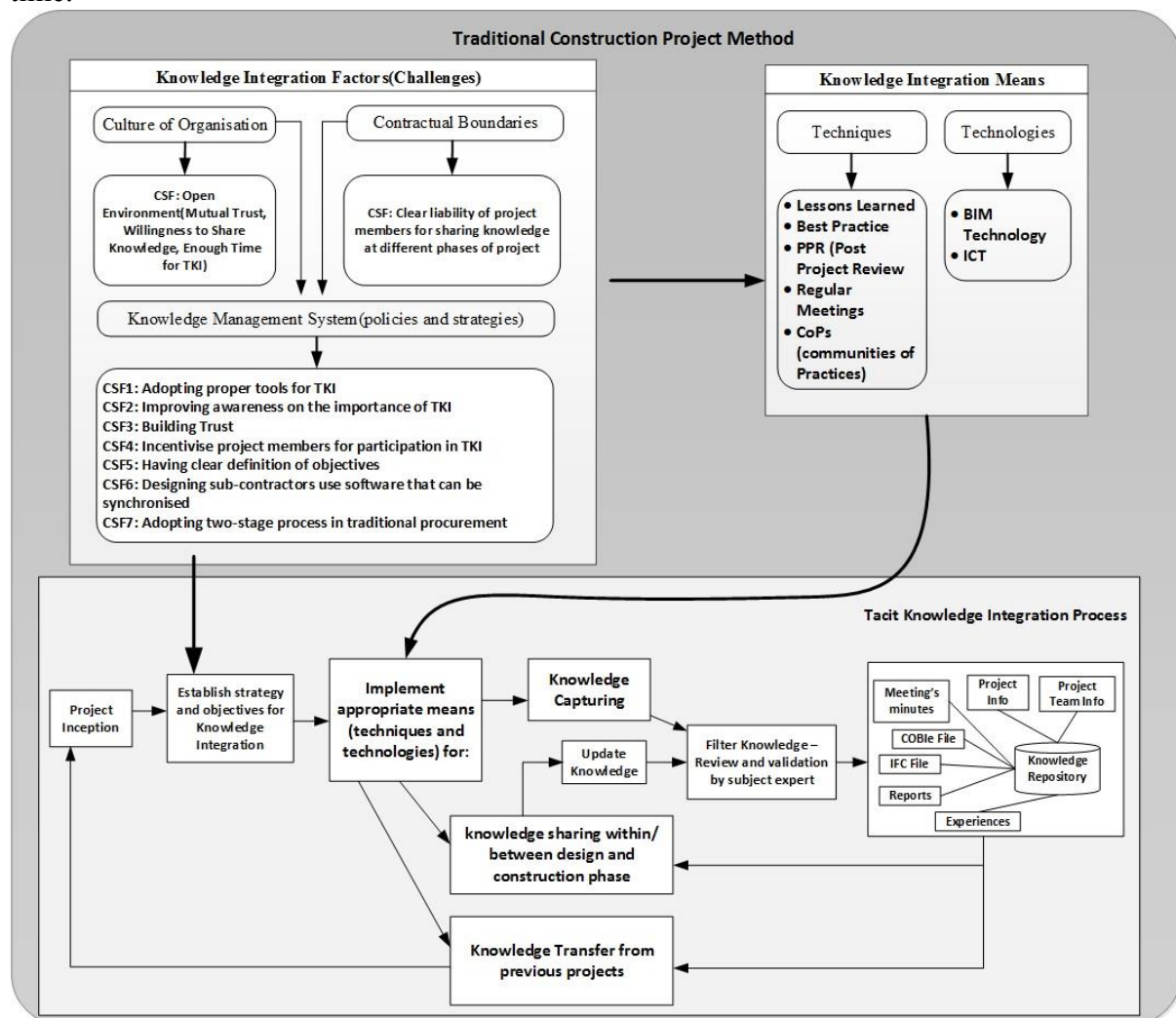

Figure 1: Revised Tacit Knowledge Integration Framework

5. FRAMEWORK GUIDELINES

Based on the feedback of the experts' opinion on the validation of the framework, a guideline was developed for the 'TKI Process'. Figure 2 illustrates the TKI framework guidelines for the construction project undertaken through the TPS. The guidelines consist of two main sections which are described below:

Brief and Design

1. Start
2. Select a Project
3. Create a KI Project File
4. Elaborating the Project
5. Has there been a similar project in the past?
 - 5.1. Yes: Identify Activity for KT (Knowledge Transfer)
 - 5.1.1. Retrieve Related Project Knowledge from Knowledge Repository
 - 5.1.2. Identify Activity for KC and KS (Knowledge Capturing and Knowledge Sharing)
 - 5.1.3. Use/Modify the repository BIM models
 - 5.2. No: Identify Activity for KC and KS
 - 5.2.1. Confirm the BIM Technology for KC and KS
 - 5.2.2. Create a BIM model/COBie File

Design and Construction

6. Is there a New KI Topic?
 - 6.1. Yes: Set up the KI Topic on Project File
 - 6.2. No: Go to 7
7. Does it Need Construction Team Involvement?
 - 7.1. Yes: Meeting with Construction Team
 - 7.1.1. Attach Files with Issues in the Information
 - 7.2. No: Edit Response on the Topic
8. Review and Validate Established Topic
9. Bank Knowledge
10. Is there another Issue?
 - 10.1. Yes: Go to 6
 - 10.2. No: Go to 11
11. End

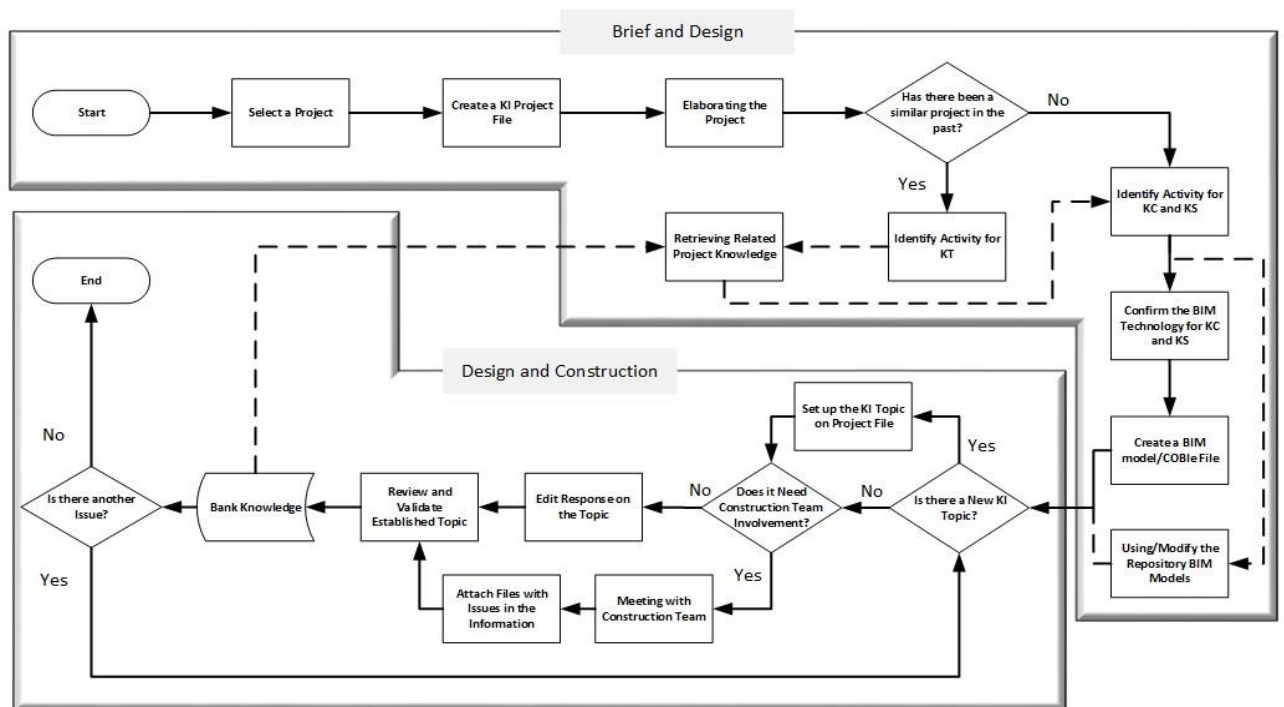

Figure 2: Tacit Knowledge Integration Framework Guidelines

6. CONCLUSION

Extension studies have been conducted in the area KM. However, studies integrating tacit knowledge in terms of capturing, sharing, and transferring within a construction project undertaken through the TPS are rare. Hence, one of the main contributions of this study is to develop a framework that bridges this gap. The framework should present how to integrate tacit knowledge, in terms of capturing, sharing, and transferring, within a construction project context undertaken through the TPS, in the UK. It was developed through the findings from the analysis of data collected from the documentary survey and qualitative data collected from the semi-structured interviews and experts' survey questionnaire. This research would enable stakeholders to be aware of the key challenges and techniques of capturing and sharing knowledge in same project and transferring it across projects within the TPS. The framework and its guidelines will help construction organisations to integrate tacit knowledge within the TPS and also to improve the awareness and understanding of individuals and organisations about KI and the use of BIM technology as a knowledge repository and its process. In turn, the practical application of this framework is to improve the efficiency of project delivery and the competitiveness of the organisation.

7. REFERENCES

- Awad, E. and Ghaziri, H. (2004) *Knowledge Management*. New Jersey: Pearson Education.
- Aziz, N., Gleeson, D., & Kashif, M. (2012). *Barriers and enablers of knowledge sharing: a qualitative study of ABB, Bombardier*. Ericsson and Siemens. School of Sustainable Development of Society and Technology, Bachelor Thesis in Business Administration.
- Cheng, M. (2009). *Research on the Knowledge Transfer in Construction Projects*, Industrial Engineering and Engineering Management, IE&EM'09.16th International Conference.
- Department for Business, Innovation and Skill (2013). *Construction 2025*. Retrieved from:

https://www.gov.uk/government/uploads/system/uploads/attachment_data/file/210099/bis-13-955-construction-2025-industrial-strategy.pdf

- Faucher, J.B.P.L., Everett, A. M. & Lawson, R. (2008). *Reconstituting knowledge management*. Journal of Knowledge Management, 12(3), 3-16.
- Kanapeckiene, L., Kaklauskas, A., Zavadskas, E.K., & Seniut, E.K. (2010). *Integrated knowledge management model and system for construction projects*. Engineering Applications of Artificial Intelligence, 23, 1200-1215.
- Love, P.E.D., Lopez, R., & Edwards, D.J. (2013). *Reviewing the past to learn in the future: Making sense of design errors and failures in construction*. Struct. Infrastruct. Eng., 9(7) 675–688.
- Masterman, J.W.E. (2002). *An introduction to Building Procurement Systems*. (2nd ed.). London: E & FN Spon.
- Nonaka, I., & Takeuchi, H. (1995). *The knowledge-creating company: how Japanese companies create the dynamics of innovation*. New York, Oxford University Press.
- Renzel, B. (2008). *Trust in management and knowledge sharing: the mediating effects of fear and knowledge documentation*, Omega, 36(2), pp. 206-22.
- Shokri-Ghasabeh, M., & Chileshe, N. (2014). *Knowledge management: Barriers to capturing lessons learned from Australian construction contractors perspective*. Construction Innovation, 14(1) 108 – 134.
- Takhtravanchi, M. and Pathirage, C. (2016), *Knowledge management challenges within traditional procurement system*, International Journal of Computer, Electrical, Automation, Control and Information Engineering, 10 (12) , pp. 2452-2460.
- Zhu, F., Sun, X., Xu, X., & Haider, Z. (2014). *A Knowledge Integration Framework of EPC Project Based on KBS and Stakeholder Networks*. International Journal of Innovative Computing, Information and Control, 10(2) 703-715.

W112: CULTURE IN CONSTRUCTION

DEVELOPING A SYSTEMS-CHANGE MODEL TO ADDRESS THE PARADOX OF CHANGING CONSTRUCTION

R. Garvey¹ and P. McDermott²

¹ *Property and Construction, University of Westminster, 35 Marylebone Road, London, NW1 5LS, UK*

² *School of the Built Environment, University of Salford, Maxwell Building, The Crescent, Greater Manchester, M5 4WT, UK*

Email: r.garvey@westminster.ac.uk

Abstract: The dysfunctional paradigm of normal practice (Barrett and Barrett, 2006) within construction would appear to be taken for granted. Whilst the challenges of operating within the industry are well documented and different solutions for improvement constantly postulated, the principal protagonists continue with business as usual, prompting a recall of Einstein's definition of insanity. Why does the industry appear incapable of achieving the sustainable change promulgated by the plethora of industry reform reports? Yet, on the other hand, there is plenty of evidence to promote a contrary view of the industry; one that is constantly evolving and developing, delivering more projects, quicker and more economically. Is this the paradox of changing construction; an industry that continually evolves despite the litany of reports calling for it to change? It is apparent that the normal practice of construction accommodates developmental change at a micro level, whereas the reform reports are recommending transformational change at a macro / mezza level. Whilst developmental change is appropriate within a system in order to maintain homeostasis, it would appear that construction is devoid of other important properties of fully functioning system. It is contended that these deficiencies contribute to the industry's inability to adopt initiatives that could be transformative. Moreover, the reform reports prescribe diagnostic solutions for the industry stakeholders to adopt, whereas the proposition is that successful client systems deploy a dialogic approach to change. By delineating a systems view of construction it is anticipated that the interconnectedness of the different systems within the industry will expose the complexities of changing the industry and enable a systems-change model to be developed.

Keywords: Change, Construction Reform, Institutionalised Inefficiency, Systems Thinking

1. INTRODUCTION

Modernise or Die is the proclamation made by the Farmer Review (Farmer, 2016) in the latest, and possibly most alarming, call for the construction industry to reform. With many different clients creating demand for a highly fragmented supply chain, it is perceived that the construction industry does not to deliver for the majority of clients nor benefit many of its suppliers, and yet the industry is apparently resistant to change. The UK Government's approach to construction could be described as incoherent, this despite the litany of calls for the industry to change and the importance of the government's role as both a client and regulator of the industry. An alternative view of the industry is that it does change and it does constantly deliver a wide diversity of challenging projects better, faster and more economically than previously. Hence, is there a paradox of changing construction: construction constantly evolves as the litany of calls for the industry to change grows every longer?

Much of the reform discourse has been descriptive in nature diagnosing what is wrong with the industry and making recommendations that appear to go unheeded. Whilst the initial Government Construction Strategy (Cabinet Office, 2011) adopted a similar diagnostic tone, the recommendations were backed up with a detailed implementation plan. The One-Year On Report (Cabinet Office, 2012a) articulated the progress made and the on-going activity which

included a series of trial projects. The evidence of the UK Government Construction Trail Projects (Cabinet Office, 2012b) into alternative procurement approaches demonstrated significant cost savings as well as other benefits and could be perceived as being overwhelmingly positive. However, the subsequent adoption of these alternative approaches is negligible.

This paper will analyse how construction changes and why the sustained change, as promulgated by the numerous industry reform reports, is not achieved and consider whether there is a paradox of changing construction. The analysis will categorise change and indicate a disconnect between the change taking place and the change desired by reform. The different types of change will be contextualised within a systems view of construction that will illustrate the hierarchy of systems, explore the interconnectedness of the different systems and challenge current thinking paradigms within the industry. In doing so, the properties of a system will be used to identify the potential deficiencies within construction. This will be used to provide the basis for the subsequent development of a systems-change model and to consider the implications for the role of the state in the future of the construction industry.

2. PARADOX OF CHANGING CONSTRUCTION

How is it that the construction industry is capable of successfully delivering a wide range of diverse projects, yet there is a constant call for the industry to reform? This is being termed “the paradox of changing construction”; the industry constantly changes, yet stays the same as the litany of calls for it to change grows every longer.

Sir Michael Latham (1994) and Sir John Egan (1998) each authored reports into the UK construction industry that are often described as seminal, meaning they were influential and innovative. Yet another report, *Never Waste a Good Crisis* (Wolstenholme, 2009) assessed the impact of Egan’s report, *Rethinking Construction*, to conclude that hardly anything had changed. *Never Waste a Good Crisis* provides an overview of all the reports into the industry (Figure 1) and offers its own recommendations for how the industry should change. All the reports provide an analysis into why construction as an industry needs to change and propose plausible recommendations on what should be done differently. Moreover, there are developments in management techniques in other industries, such as, *inter alia*, lean thinking and supply chain management, that have resulted in change that are not widely adopted within the construction industry. Hence, it raises the question as to why construction does not change?

There have been numerous reports written since *Never Waste a Good Crisis*, including the *Low Carbon Construction Report* (Innovation and Growth Team, 2010), *Infrastructure Cost Review* (Infrastructure UK, 2010), the *Government Construction Strategy (GSC)* (Cabinet Office, 2011), the *Industrial Strategy for Construction (Construction 2025)* (BIS, 2013) and *The Farrell Review of Architecture and Built Environment* (Farrell, 2013). The value of this growing list of publications can be debated, however the challenge for the wider construction industry is to absorb and prioritise the plethora of recommendations into a meaningful agenda for change. Whilst each report undoubtedly makes a valid contribution to the potential progress of the industry, the concern is what individual contribution does each report make amongst a cacophony of other contributions and hence what lasting influence is actually made. Further noise was added to the crescendo for change with the *Farmer Review* (2016) proclaiming the industry must *Modernise or Die*, reiterating calls for change.

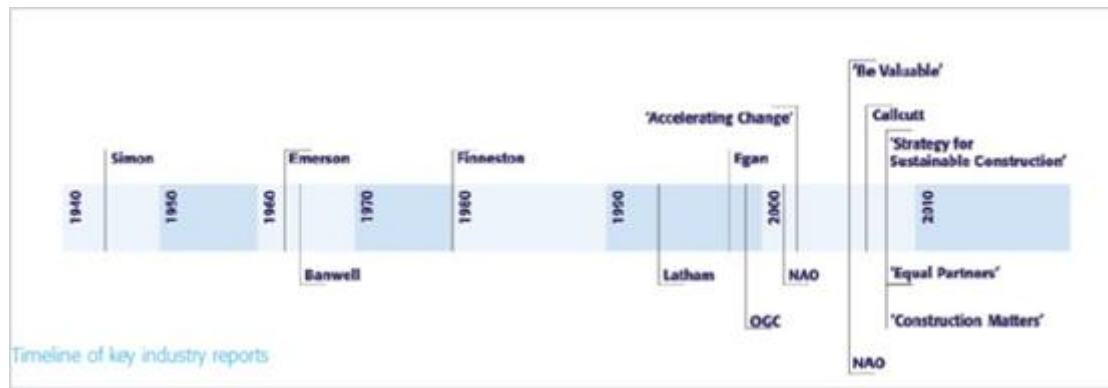

Figure 1 Timeline of Reports in Construction (Wolstenholme, 2009)

The more recent calls for change are against a backdrop of the UK construction industry delivering significant projects such as the Shard and London 2012 Olympics and Paralympic Games on time and on budget (Reynolds, 2017). This would seem to imply a disconnect between the change that actually takes place and the change demanded by industry reform. To examine this disconnect, it is necessary to understand the theory of change, the types of change and other influencing factors that could differentiate why change occurs or not as the case maybe.

Within the field of construction research, Price and Chahal (2006, p237–251) provide an effective overview of change management theory in an attempt to develop a strategic framework for change. Their framework is focused on the organisation and concludes that successful change requires an effective process, as well as strong leadership and alignment of the organisational culture. Price and Chahal identify types of strategic change as either reactive or proactive, which can result in a change in organisational performance that is either developmental (small scale) or transformational (significant scale). McGahan (2004) considered how industries change, developing a model that maps an industry's evolution along four distinct trajectories: radical, progressive, creative or intermediating against the threat of obsolescence to core assets or activities. McGahan's model aligns with Price and Chalal's analysis of drivers for change being either reactive or proactive leading to either development or transformational outcomes. The inference from this analysis is that the changes that do take place within construction are reactive, small scale and more developmental; whereas the change prescribed within the industry reform discourse is proactive and transformational.

The majority of literature on change is focused on either individual or organisational change rather than industry level change. Moreover, the emphasis is on the process of change; identifying what needs to change and for whom, who manages the change and how is it managed (Hayes, 2014; Kotter, 1996). These processes are non-industry specific. Whilst McGahan (2004) investigated how industries change, the conclusion to be drawn is that it is of limited use as it is retrospective and fails to provide a clear forward looking perspective on how to influence change. Moreover, that change does not actually take place at an industry level, but within the organisations that constitute the industry. Hence, it could be argued that if the industry reform reports are endeavouring to influence change at an industry level then they are ultimately destined to fail.

Why does change take place? Price and Chalal suggest that reactive change is imposed due to a crisis or when stakeholders face conflict (competition); whereas proactive change is the result of a deliberate course of action and where stakeholders seek consensus. However, they further

add that transformational change is more likely to result from conflict rather than adaption. McGahan suggests that radical change will occur when an industry’s core assets and activities are threatened with obsolescence. The implications from this are that the industry change that does take place is because of competition and not through consensus. Moreover, that whilst industry reform may call for change, the industry’s core assets and activities are not sufficiently threatened with obsolescence to instigate the prescribed radical change.

Todnem By et al (2011, p1–6) in considering the future direction of change management reflect that the roots to change management go back to late 1940s and 1950s and has primarily focused on enhancing organisational performance. They argue that, not unlike the literature on leadership, too much emphasis has been placed on the actors (of change/leadership) rather than on the acts. Hence they are looking to reframe change management from a strategic tool to an “everyday distributed practice” that should encompass processes of social change rather than solely focusing on organisational change. To this end, the authors refer to Bushe and Marshak’s categorisation of change as dialogic or diagnostic. The premise is that most change initiatives are diagnostic, problem-solving, rather than dialogic which focuses on social change with a view to changing mind-sets. The authors do contend that dialogic change involves a different approach to the planned, mechanistic processes of diagnostic change; which could be interpreted as “woolly”. Hence, it is posited that most construction reports are indeed diagnostic, rather than dialogic, in nature.

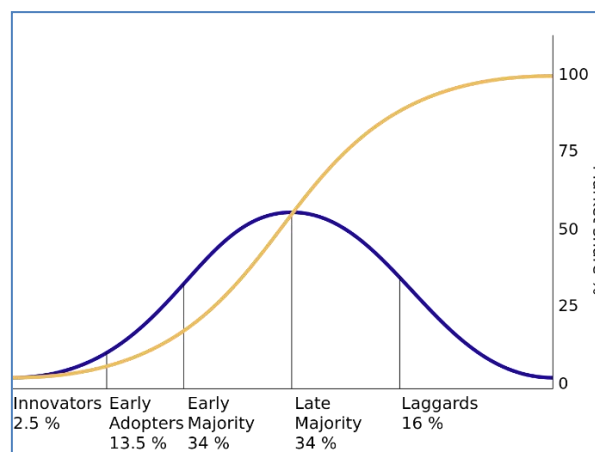

Figure 2 Diffusion of Innovation (From Rogers 1963, taken from Diffusion of innovations, 2015)

It is pertinent to reflect on the assertion made by Smiley et al (2014, p804–815) that “scholarly analyses of the reform agenda have tended to adopt a Critical Theory perspective” and in doing so lack a broader socio-historical cultural perspective. It is their contention that the reform discourse, analysed through a critical theory lens, provides limited insight into behavioural aspects that shape the formulation of policy in the first place. Given the claim that industry reform has been diagnostic in nature, further research will focus on whether the lack of emphasis on dialogic change within the reports is a contributing factor to the lack of influence and failure to institute lasting change. Moreover, if we consider the diffusion of innovation (Figure 2, Sinek, 2009), then the question is whether the reports have given sufficient attention to considering the population that is looking to be changed; firstly by understanding what is required to reach the tipping point and secondly, what needs to be done to influence the early adopters and early majority.

A summary of the key differences between the industry change taking place and that prescribed in industry reform reports are shown in table 1.

Table 1 The current state of change within construction compared with change desired by reform

<i>Change factors</i>	Current state	Desired by reform
<i>Type</i>	Reactive, Developmental	Proactive, Transformational
<i>Level</i>	Organisational level	Industry Level
<i>Rationale</i>	Conflict, competition	Consensus / adaption
<i>Method of implementation</i>	Diagnostic	Diagnostic

The intention here has been to focus on the nature of change in construction rather than concentrate on the details of precisely what needs to change. The challenges of the industry are well documented and there is no shortage of solutions, however there does appear to be a problem with instigating change that achieves a sustained resolution to these industry challenges. It is proposed to analyse construction as a system using systems theory as an analytical lens to investigate this problem further.

3. A SYSTEMS VIEW OF CONSTRUCTION

The need to consider a systems approach to address the challenges of construction is not new. Carassus (2004) edited the CIB report “The Construction Sector System Approach: An International Framework” which adopted mesoeconomic or sector system approach to analyse “the operation and function of the construction sector within the economy”. Fernández-Solís (2008, p31–46) considered the systemic nature of the construction industry focusing on the complexity of the industry. Barrett and Barrett (2006, p201–215) describe “the dysfunctional paradigm of normal practice” and refer to the development of the infinity model (Barrett, 2007) requiring the adoption to more systemic approach to construction. Winch (2009) suggests that systems thinking has a role to play in addressing the “vicious circle that constrains the performance of a construction project”. More recently, Sarhan et al (2017, p12–24) introduce the concept of institutionalised waste and suggest resolution requires attention to shift to thinking systemically and structurally. Awuzie and McDermott (2016, p268–283) adopt a systems approach to assess the organisational viability in project based organisations. Hence there is already a body of work that has considered a systems approach in construction and which recognises not only the significant impact of systems theory, but also the evolution and development of the many different types of systems theory. Initially, this work will focus on the basics of systems theory and consider how the properties of systems can be used to consider the construction system.

The first point to consider is whether construction is a system. It is not proposed to debate this now, but it is necessary to recognise that construction is not one system but a collection of interconnected systems. Before this is reviewed in more detail, the properties of an individual system will be explored. According to Perkins (2015) a system consists of the following properties (Figure 3); firstly, a system has boundaries that are either open or closed; within the boundaries, energy inputs into the system via the interface whereby it is transformed in throughput before exiting via another interface as output. A system requires feedback about its performance, whether negative or positive. Another property is that systems seek

homeostasis, that is regulators maintaining the equilibrium of the system; this does not mean that change does not occur, but that the change that does take place does not overwhelm the system, or at least the system tries to keep change from overwhelming it. The synergy of the system means that the whole is greater than the sum of its parts. Other properties are reciprocity, where a change in one part of the system will reverberate through the system and differentiation, where the maturity of a system increases its complexity.

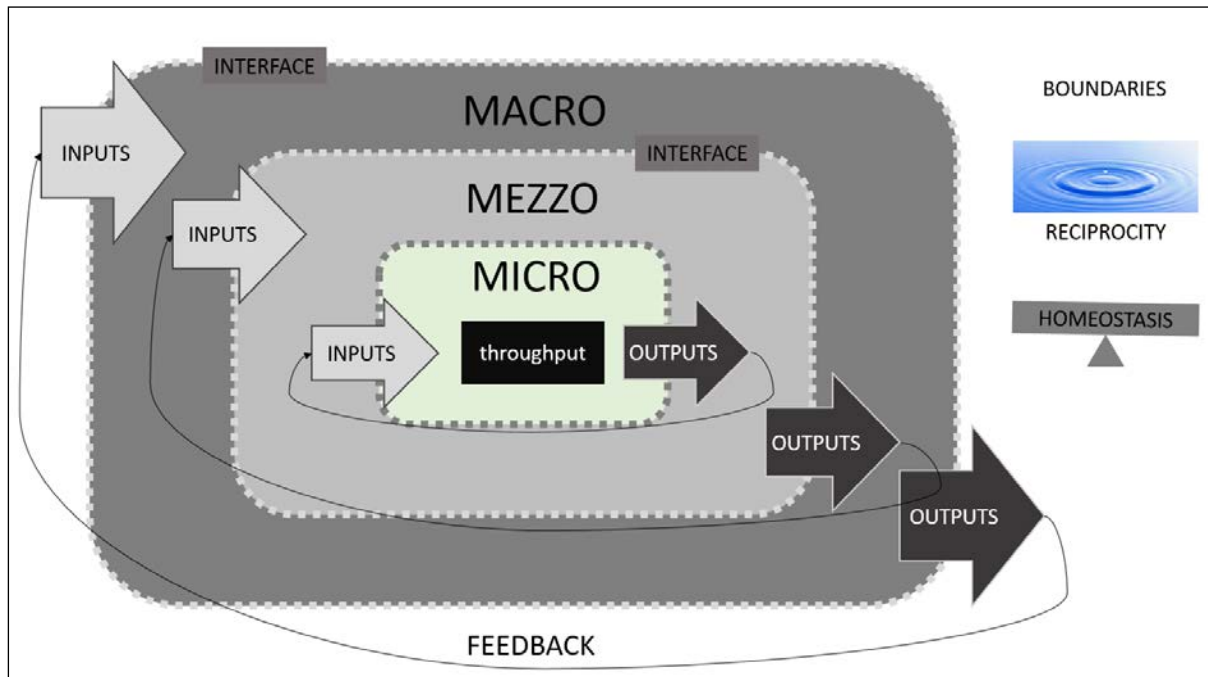

Figure 3 Properties of a system (adapted from Perkins, 2015)

If construction is assessed as a system against these properties, it raises the following questions; what is the energy of the construction system; where are the boundaries and what are the inputs, throughput and outputs of the system and what is the nature of the feedback and regulation within the system? Acknowledging that there is more than just one system that constitutes construction, it is interconnection of many different systems, it demands an understanding of the different systems within construction. It is also pertinent to recognise that system theory describes three different levels of systems; marco, mezza (or meso) and micro (Perkins, 2015) and therefore it would also be appropriate to categorise the different systems within construction according to their level.

The intention is not to provide a fully detailed analysis of this systems view here, suffice to address some key observations from the previous research that has considered a systems approach to construction. Acknowledgement is given to The Tavistock Institute (1966) which was the first research to use systems theory. This report distinguished between the “client system” and the “system of operations”, the complex set of activities and relationships (throughput) required to derive the output. Many of the issues raised by this report are still relevant today, not least the question “Does the normal practice of organising construction allow the basic operations of the building process to be realised more effectively than any other?” (page 42). The report identifies that within the formal system of operations created by the contractual arrangements between the different “resource controllers”, an informal system exists because the formal system is dysfunctional. Significantly, the dissatisfaction of clients is also highlighted; The Director of Building at the Ministry of Public Building & Works quote is summarised as “How many clients, faced with the discrepancies of time and cost at the end

of the project feel satisfied that the competitive market has given them protection?” If the construction system was an effective system, information from feedback loops should be able to quantify this question; however, it is apparent that such feedback is absent from many systems within construction (Awuzie and McDermott, 2016, p268–283; Barrett, 2007; Fernández-Solís, 2008, p31–46; Sarhan et al., 2017, p12–24; Winch, 2009).

Much of the literature concentrates on the construction project as a system (Awuzie and McDermott, 2016, p268–283; Ballard, 2008, p1–19; Winch, 2009). However, it is questioned whether the project is a sub-system of a client system, “which in turn is a “sub-system” of the industry” (Chapman, 2001, p147–160) or it is the throughput of the client system? Moreover, there is limited attention directed at the theoretical dynamics of change and understanding how change theory could provide insights into addressing the dysfunctionality of normal practice. Tables 2 and 3 use the properties of a system to assess the change currently taking place and the change desired by reform.

Table 2 Current state of change within construction assessed as a system

Change factors	Current state	Assessed as a system
<i>Type</i>	Reactive, Developmental	Change is a normal aspect of a system; this type of change is healthy
<i>Level</i>	Organisational level	Appropriate
<i>Rationale</i>	Conflict, competition	Devoid of effective regulation and feedback
<i>Method of implementation</i>	Diagnostic	Devoid of system thinking, could be described as command and control

Table 3 Change as desired by reform assessed as a system

Change factors	Desired by reform	Assessed as a system
<i>Type</i>	Proactive, Transformational	Transformational change could overwhelm a system and cause an imbalance in homeostasis; chaos theory is a development of systems theory that considers this
<i>Level</i>	Industry Level	Appropriate, however reciprocity needs to be considered and how change made at this level reverberates through the system
<i>Rationale</i>	Consensus / adaption	Again, what is the evidence for the change; devoid of feedback and control mechanisms
<i>Method of implementation</i>	Diagnostic	Devoid of system thinking, could be described as command and control

4. DISCUSSION

The normal practice of construction has been characterised as dysfunctional (Barrett and Barrett, 2006). Given the general awareness of the outputs from this system are unlikely to

result in satisfied clients, it seems that the industry is either resistant to change or incapable of change; whatever the reason, a systemic reboot would appear to be required. This is akin to the metaphor of a psychic prison (Morgan, 2006) whereby organisations are described as getting “locked into modes of industrialized inefficiency”. When this occurs it is because the systems of control have “institutionalised the error-producing process further by accepting a certain percentage of damaged products, waste and inefficiency as the norm”. The implication is that buffers are created to deal with uncertainty to protect the system, yet these very same buffers perpetuate inefficiency created by the slack within the system and raises the question as to what constitutes the buffers within construction? Further work is required on this issue, but the contention is that the process of managing risk and uncertainty has influenced a fragmented system where each actor is keen to protect their own interests at the expense of the synergy of the whole system.

Morgan’s work was analysed by Green (2011) in relation to construction, acknowledging that the psychic prison metaphor could be useful in “identifying barriers to change and innovation”. It would also suggest that the identification of institutionalised waste by Sarhan et al (2017b) could be an important contribution to highlighting the inefficiencies of the construction process; the contention here is that by increasing the transparency of performance in the industry could be a potential catalyst for change. Again, this is not something new to the industry. The Tavistock Institute report (1966) quoted Medawar’s 1959 Reith Lecture which cautioned that whilst “Natural evolution may seem to be a proper vehicle for change...it is a process for waste, makeshift, compromise, and blunder”, and therefore urged future research to seek the benefits of natural evolution “but with a dispatch that the natural process lacks”. This is interpreted as needing to embrace the positive aspects of developmental change, but with an approach that results in a more transformative impact; the problem to be further investigated is how to achieve this. It is proposed to investigate a number of different client systems that proclaim to achieve improvement through operations that consist of system properties such as feedback, regulation and transparency over performance. Using a case study approach, client systems will be analysed the against the systems-change model to be developed and to assess the inter-relationships between the different systems in construction and expose the complexities of changing construction. The case studies will provide evidence of change within the client systems and how this has resulted in improvement, if any. The implications of these findings will be used to consider the future role of the state in reforming construction.

5. CONCLUSIONS

It has been determined that there is a paradox of changing construction, that whilst the industry continues to evolve and change, the calls for reform persist. Given the general awareness of the dysfunctional nature of the normal practice of construction and the plethora of solutions to improve the industry, why is it that the industry appears not to change; is it resistant or is it incapable? Evaluating change theory, it is evident that there is a disconnect between the developmental change that occurs within the industry and the transformative change desired by industry reform reports. Reform discourse often refers to industry level or macro level change; however, change is shown not to take place at this level. Change takes place at micro level or within organisations. Moreover, it was highlighted that whilst change may be desired, radical change will not take place until the industry’s core assets and activities are threatened with obsolescence; it is debated whether this is the case in the construction industry. A further categorisation of change is whether the approach deployed is diagnostic or dialogic; dialogic

change is focused on changing mindsets whereas diagnostic change is more prescriptive. Hence, it is posited that most construction reports are diagnostic, rather than dialogic, in nature. Given these factors, it is postulated that industry reform reports were always destined to fail and an alternative approach is required.

Using systems theory, it has been shown that developmental change is a natural property of a system; however, the transformative type of change promulgated by the reform reports has the potential to unsettle the homeostasis of a balanced system unless the reciprocity is considered and addressed. It is apparent that systems in construction are devoid of the properties of feedback and regulation with the potential to constrain learning and instigate improvement. It is contended that these deficiencies contribute to the industry's inability to adopt initiatives that could be transformative. The proposition is to undertake research that develops a systems-change model based on a systems view of construction that delineates the interconnectedness of the different systems within the industry and exposes the complexities of changing the industry. The systems-change model will be used to analyse client systems that proclaim to achieve improvement through operations that consist of system properties such as feedback, regulation and transparency over performance. The implications of these findings will be used to consider the future role of the state in reforming construction.

6. REFERENCES

- Awuzie, B. and McDermott, P. (2016). A systems approach to assessing organisational viability in project based organisations. *Built Environment Project and Asset Management*, 6 (3), 268–283.
- Ballard, G. (2008). The Lean Project Delivery System: An Update. *Lean Construction Journal*, 2008 1–19.
- Barrett, P. and Barrett, L. (2006). The 4Cs model of exemplary construction projects. *Engineering, Construction and Architectural Management*, 13 (2), 201–215.
- Barrett, P., professor (2007). *Revaluing construction*. Oxford: Oxford : Blackwell.
- BIS (2013). *Industrial Strategy: government and industry in partnership: Construction 2025*. London: Department for Business, Innovation & Skills.
- By, R.T., Burnes, B. and Oswick, C. (2011). Change Management: The Road Ahead. *Journal of Change Management*, 11 (1), 1–6.
- Cabinet Office (2011). *Government Construction Strategy*. London: Cabinet Office.
- Cabinet Office (2012a). *Government Construction Strategy, One Year On Report and Action Plan Update*. London: Cabinet Office.
- Cabinet Office (2012b). *Government Construction Trial Projects*. Available from <https://www.gov.uk/government/collections/government-construction>. Available from https://www.gov.uk/government/uploads/system/uploads/attachment_data/file/62628/Trial-Projects-July-2012.pdf [Accessed 14 May 2015].
- Chapman, R.J. (2001). The controlling influences on effective risk identification and assessment for construction design management. *International Journal of Project Management*, 19 (3), 147–160.
- Diffusion of innovations (2015). Wikipedia. Available from https://en.wikipedia.org/w/index.php?title=Diffusion_of_innovations&oldid=777739488 [Accessed 4 January 2015].
- Egan, S.J. (1998). *Rethinking Construction The Report of the Construction Task Force*. London: DETR.
- Farmer, M. (2016). *The Farmer Review of the UK Construction Labour Model*. 80. Available from <http://www.cast-consultancy.com/wp-content/uploads/2016/10/Farmer-Review-1.pdf> [Accessed 18 October 2016].
- Farrell, S.T. (2013). *The Farrell Review of Architecture and the Built Environment*. London: Farrells. Available from <http://www.farrellreview.co.uk/download>.
- Fernández-Solís, J.L. (2008). The systemic nature of the construction industry. *Architectural Engineering and Design Management*, 4 (1), 31–46.
- Green, S.D. (2011). *Making sense of construction improvement*. Chichester, West Sussex, UK ; Ames, Iowa: Chichester, West Sussex, UK ; Ames, Iowa : Wiley-Blackwell.
- Hayes, J. (2014). *The Theory and Practice of Change Management: Palgrave Higher Ed M.U.A*. Available from <https://www.dawsonera.com:443/abstract/9781137289025>.

- Infrastructure UK, H.T. (2010). Infrastructure Cost Review: Main Report. London: Infrastructure UK, HM Treasury. Available from https://www.gov.uk/government/uploads/system/uploads/attachment_data/file/192588/cost_review_main211210.pdf.
- Innovation and Growth Team (2010). Low Carbon Construction: Final Report Available from [Last accessed: 5th February 2015]. London.
- Kotter, J.P. (John P., 1947- (1996). *Leading change*. Boston, Mass.: Boston, Mass. : Harvard Business School.
- Latham, S.M. (1994). *Constructing the Team Joint Review of Procurement and Contractual Arrangements in the United Kingdom Construction Industry*. London: HMSO. Available from <http://constructingexcellence.org.uk/resources/constructing-the-team-the-latham-report/> [Accessed 28 June 2017].
- McGahan, A.M. (2004). *How Industries Change*. Harvard Business Review. Available from <https://hbr.org/2004/10/how-industries-change> [Accessed 9 May 2015].
- Morgan, G. (2006). *Images of organization* Updated ed. Thousand Oaks: Thousand Oaks : Sage Publications.
- Introduction to Systems Theory (2 November 2015). Directed by Mike Perkins. Available from <https://www.youtube.com/watch?v=jY7638w6gkI>.
- Price, A.D.F. and Chahal, K. (2006). A strategic framework for change management. *Construction Management & Economics*, 24 (3), 237–251.
- Reynolds, M. (2017). The next PM must support the UK’s world-class construction sector. Available from <http://www.cityam.com/266099/next-government-must-support-uks-world-class-construction> [Accessed 28 June 2017].
- Sarhan, S. et al. (2017). Contractual governance as a source of institutionalised waste in construction: A review, implications, and road map for future research directions. *International Journal of Managing Projects in Business*, 10 (3), 550–577.
- Sarhan, S., Pasquire, C. and King, A. (2017). The concept of ‘institutional waste within the Construction industry’: A potential theoretical framework. *Lean Construction Journal*, (2017), 12–24.
- How great leaders inspire action (1 September 2009). Directed by Simon Sinek. Available from https://www.ted.com/talks/simon_sinek_how_great_leaders_inspire_action [Accessed 4 January 2015].
- Smiley, J.-P., Fernie, S. and Dainty, A. (2014). Understanding construction reform discourses. *Construction Management and Economics*, 32 (7–8), 804–815.
- The Tavistock Institute (1966). *Interdependence and Uncertainty: A study of the Building Industry*. London: Tavistock Publications.
- Winch, G.M. (2009). *Managing Construction Projects* 2nd Edition. Chichester: Wiley-Blackwell. Available from <http://www.wiley.com/WileyCDA/WileyTitle/productCd-1405184574.html> [Accessed 21 June 2017].
- Wolstenholme, A. (2009). *Never Waste A Good Crisis*. Available from <http://constructingexcellence.org.uk/resources/never-waste-a-good-crisis/> [Accessed 15 May 2015].

MOTIVATIONS, SUCCESS FACTORS, AND BARRIERS TO THE ADOPTION OF OFFSITE MANUFACTURING IN NIGERIA

F. Pour Rahimian¹, J.S. Goulding², A. Akintoye³ and S.J. Kolo⁴

¹ *Department of Architecture, University of Strathclyde, 75 Montrose Street, Glasgow G1 1XJ, UK*

² *Department of Architecture and Built Environment, Northumbria University, Newcastle, NE1 8ST, UK*

³ *School of Built Environment and Engineering, Leeds Beckett University, City Campus, Leeds, LS1 3HE, UK*

⁴ *School of Engineering, University of Central Lancashire, Preston, PR1 2HE, UK*

Abstract: Despite several mitigation attempts, Nigeria is still facing a deficit of 17 million houses. Seminal literature argues that this problem is predominantly due to a myriad of issues, including high construction costs, skills shortages, the slow pace of construction, lack of infrastructure and logistics, poor quality of available housing stock etc. Given these issues, offsite manufacturing has been proffered as an innovative method for addressing these challenges. This paper reports on the findings of a feasibility study which investigated the Nigerian stakeholders' perceptions on the needs, promises and barriers of adopting offsite manufacturing in Nigeria. To achieve this, in-depth interviews were conducted with experts directly involved in housing delivery. Data gathered from the experts were analysed using thematic analysis, and Nvivo software was used to transcribe and analyse the research data. Findings from the in-depth interviews highlighted that the housing deficit in Nigeria is on the increase and nothing significant was being done at the moment. Stakeholders also posited that although OSM could improve housing delivery efforts in Nigeria, the prevalence of this is still considerably low; and that this was influenced by many factors, such as negative local perception about OSM, client resistance, lack of infrastructure and skills shortage. This study concludes that for OSM to be adopted in Nigeria, there is a need for greater awareness, collaboration, training and encouragement from Government. This study presents additional understanding of OSM in Nigeria based on expert opinion, the results of which were used to develop a framework for the effective adoption of OSM in Nigeria. It is contended that the adoption of OSM could help support housing delivery efforts in Nigeria, and may also leverage wider benefits to the construction industry and associated supply chain.

Keywords: Barriers, Nigeria, Offsite, Roadmap, Stakeholders, Supply Chain

1. INTRODUCTION

Nigeria is currently facing a significant and progressive housing deficit. Whilst it could be argued that this is similar to many other rapidly developing countries, there are some unique contextual facts that need to be noted. For example, it has a population of 177 million, with an annual growth rate of about 2.5% (PRB, 2014). It also needs about 17 million new houses in short term (Okonjo-Iweala, 2014). Thus, in order to address these issues, several mitigation efforts have been deployed by the local industry, including: promoting locally manufactured building materials as a means to improve housing delivery (L.M. Olayiwola & Adedokun, 2014); pushing the industry towards better implementation of the Nigeria National Housing Policy (Makinde, 2014); and seeking possibilities for introducing better mortgage systems in Nigeria (L.M. Olayiwola & Adedokun, 2014). Notwithstanding these attempts, a wide margin still exists between housing demand and supply (Ibimilua & Ibitoye, 2015). It has also been argued in seminal literature that these problems are mainly due to the inherent challenges of the exiting conventional housing delivery systems in Nigeria, particularly: time and cost overruns, skills shortage, inadequate quality, and labour intensive activities (Femi & Khan, 2014; Makinde, 2014; Njoku & Adegboye, 2015; Omotayo & Keraminiyage, 2014; Rahim & Haron, 2013). As such, Dada (2013) suggested that a paradigm shift from the conventional construction approach to a more innovative housing production processes was vital for Nigeria.

This kind of radical change in housing delivery methods has also been advocated in several other countries, including the UK (Egan, 1998; Latham, 1994); USA (CERF, 1995); Australia (DISR, 1999) and in South Africa (DPW, 1998). The essence of all of these major Government reports is that collaborative working and integrated project delivery must be promoted in order to make a ‘revolution’ in construction projects. To leverage these, seminal literature has proffered the adoption of Modern Methods of Construction (MMC) and Offsite Manufactured Construction (OSM) as viable delivery mechanisms for both developed and developing countries (e.g., Gibb & Pendlebury, 2006; Jack S. Goulding & Lou, 2013; J. S. Goulding et al., 2014; Mullens & Arif, 2006; Wafaa Nadim, 2012; W. Nadim & Goulding, 2010; Taylor, 2009). In this respect, the primary role of OSM here is to move some of the effort and risk-prone construction site activities into a controlled environment - typically associated with a manufacturing or factory facility (Mohammed Arif & Egbu, 2010). This controlled environment and application of OSM offers several benefits, particularly: a higher speed of construction; improved quality of the finished product; lower costs; and lower labour requirements on-site (Mullens & Arif, 2006). These achievements are sustained and significant, which offer a palpable platform for addressing the specific housing problems of Nigeria (discussed above).

Notwithstanding the aforementioned benefits of OSM, the use and deployment of OSM and MMC in the Nigerian housing market is negligible (Kolo et al., 2014). On this theme, Taylor (2009) asserted that failure in many countries could be due to inaccurate public assumptions regarding offsite. Similarly, Mohammed Arif et al. (2012b) argued that much of this miscommunication among different sectors of the housing industry, could potentially hinder the adoption of OSM and exacerbate the lack of consent between industry and academia in terms of remit, functionality, expectations, motivations, and final goals. In other words, there are multi-aspect drivers that affect the process of industrialising the sector as a whole, not least semantics and technology adoption issues (Rahimian & Ibrahim, 2011). These are significant challenges. This study therefore posits that, if offsite production and manufacturing are to make a positive contribution to the Nigerian construction industry, there is a need to identify the causal drivers and issues associated with the uptake and adoption of this. This undertaking needs to encompass several areas, not least, market drivers and dynamics, culture, societal issues, and existing economic business models.

Given the importance of these factors, this study investigated these issues within the context of Nigeria; specifically, to identify the pivotal drivers and priorities of OSM for future uptake. The aim of this study is to develop a research roadmap which identifies prioritised areas for OSM adoption in Nigeria. This paper presents the results of in-depth interviews conducted with 26 experts who have been directly involved in Nigerian construction industry for several years, in order to identify the main motivations, success factors, and barriers to the adoption of OSM in Nigeria.

2. RESEARCH METHODOLOGY

The fundamental concept of epistemology relates to the nature and study of knowledge. This includes rationality (belief), philosophy (nature of knowledge), and more fundamentally, justification (of this belief and nature of knowledge). Notwithstanding the debate on paradigm ‘wars’, one aspect of discovery is known as “pragmatism” or the pragmatic maxim, where an ideology or proposition is ‘grounded’ through practical consequences in order to reconcile claims through evidence. Acknowledging this, the research lens and framing for this study

adopted a pragmatism research philosophy. For wider discourse, and applicability to contexts and positioning, see (Mertens, 2015); Creswell (2013); Fellows and Liu (2015); and Holt and Goulding (2015). This philosophy was adopted as the research sought to understand the problems of housing in Nigeria, including sustainable ways of addressing these problems using pluralistic approaches. A combination of deductive (quantitative) and inductive (qualitative) approaches [see Bryman, 2015] were deployed in order to not only achieve greater understanding on the appropriateness of data-collection and data-analysis, but also on the approaches needed to secure data veracity. Given this, an explicit mixed-methods approach was adopted to eliminate arbitrary boundaries or assumptions; thereby creating replicable recipes for future studies of this type.

The aim of this study was to determine the motivation, success factors, and barriers of OSM adoption in Nigeria. As such, the literature review identified the main problems affecting housing delivery in Nigeria; moreover, it also highlighted the globally capabilities of OSM for addressing these issues, including the barriers for effective transformation. Research findings were used to develop an outline theoretical roadmap, including the main constructs, factors and variables associated with this study.

One of the key challenges in this study was securing confirmation. In particular, affirmation of developed theories matched with the tacit knowledge of stakeholders involved in the Nigerian housing industry. Research in this area is particularly limited, requiring the appropriation of suitably experienced actors in order to fully appreciate and understand the contextual boundaries. From a data collection perspective, in-depth interviews were deployed as the instrument for data collection. This was chosen to purposefully engage with the stakeholders in order to secure their views and opinions, whilst also capturing deeper knowledge on the nature of these issues.

From a sampling perspective, 26 high-level experts from various sectors of the Nigerian housing industry were selected and invited as participants for the in-depth interviews. These experts were purposefully sampled in accordance with their roles within the housing delivery value chain, and their engagement with Federal and State Government Institutions. These type of stakeholders have been identified as the main players of housing delivery value chain in Nigeria by Okonjo-Iweala (2014), and were thus targeted for this study. The full list of institutions and departments that participated in this study included: CITEC and ADKAN; ASO Savings and Loans PLC; Federal Housing Authority (FHA); Federal Mortgage Bank of Nigeria (FMBN); Federal Ministry of Lands, Housing and Urban Development (FMLHUD); Federal Ministry of Finance; and the Central Bank of Nigeria.

The criterion for selecting individual experts from the identified organisations was made on: managerial position; experience of the Nigerian housing sector; and involvement in shaping high-level policies, and controlling/guiding operations. The sample respondents of this study included: 9 participants from the real estate developers (as real estate developers are involved in the highest number of houses in Nigeria); 5 participants from the public housing providers (as they are the Government agencies responsible for building houses throughout the federation); 7 participants from mortgage banks (because of their role in the financing of housing of projects and also issuing mortgage in Nigeria); and 5 participants from the Federal Ministry of Lands, Housing and Urban Development (because of their role in formulating policies for the housing sector).

From the 26 interviewees, the experts from the real estate developers were managing directors, project managers and senior technical staff who help shape policies in these companies. The experts from the public housing providers were all general managers in charge of the 5 technical divisions of the parastatal. The mortgage bank experts were all managers responsible for policy making and approving loans for housing construction. Lastly, the experts from the ministry were responsible for formulating policies for the housing sectors and were all directors in charge of key departments (e.g. architectural services and land acquisition). They also had responsibility for shaping housing policies for the government.

This study followed Gu and London (2010) approach for shaping the main constructs of the study. Interview questions were framed around the three main dimensions of OSM, i.e. people, process and technology. As an additional dimension, cost was also included as a fourth construct, as this has been identified as a major component in previous studies. Interview questions were divided into three main categories, specifically: 1) Concerning the main problems of housing in Nigeria, 2) The potential capabilities of OSM, which can leverage housing delivery in Nigeria, and 3) The anticipated barriers to OSM adoption in Nigeria.

In order to assure maximum engagement with respondents, face-to-face meeting were selected as the method of conducting interviews, and a 30 minute time period was allocated for each session. Interview questions were adjusted to accommodate the expertise of each participant in order to develop deeper and more meaningful insight. Reaching theoretical saturation (Kumar & Phrommathed, 2005) was the main strategy for determining sample size of each set of interviews; i.e., the study continued with the interviews from each group until the point where no new data could be collected.

Data gathered from the 26 interviews was then transcribed and analysed using QSR - NVivo Data Analysis Software (V10.0.638). This was undertaken in order to gain insight into the main themes of the core issues of the study. Initially, a Word Cloud Query and exploratory analysis on the whole database of results was undertaken. From this, the importance of factors such as people, and existing policies, infrastructure, standards and technology in place were highlighted. Of particular note, was the concern from respondents that adopting offsite construction in Nigeria would not be an easy task due to several potential barriers.

In order to systematically investigate the core issues of housing delivery in Nigeria and evaluate the potential of OSM in addressing these, thematic content analysis (Sommer & Sommer, 1991) was used, engaging themes and coding adapted from similar studies (e.g. Femi & Khan, 2014; Makinde, 2014; Ndarni & Angbo, 2014). The identified themes concerning the problems of housing delivery in Nigeria were ascribed as follows: “financial issues”; “the construction sector”; and “the Government”. The study then developed a coding scheme for data analysis based on these themes. High-level themes and codes employed in this study are presented in Table 1. The main themes associated with how OSM could support the construction industry in Nigeria included Government initiatives and motivations of other stakeholders (with respect to potential benefits of OSM). The themes relating to barriers of OSM adoption were identified as being human barriers, technical barriers, and industrial barriers. The themes and codes related to these two parts of study were adopted from J. S. Goulding et al. (2014) which investigated nine core areas of concern for OSM adoption, representing the three major dimensions of OSM: Process, Technology and People, and their impact on: Design, Manufacturing and Construction. The study also adopted a snowball approach (Kumar & Phrommathed, 2005) for continually developing codes of analysis based on the responses received from interviewees.

Table 1: Themes on Problems of Housing Delivery in Nigeria

Problems of Housing Delivery in Nigeria	Financial Issues	High Cost
		Importation of Materials
		Poor Earning Power
	Construction Sector Related Issues	Lack of Innovation
		Lack of Construction Standards and Poor Ethics
		Lack of Research and Development
	Government Related Issues	Poor Government Policies
		Inflation of Contract Prices
		Sharp Practices

3. RESULTS AND DISCUSSION

3.1 The problems of housing delivery in Nigeria

From the exploratory analysis of the interview results, it can be seen that despite various mitigation attempts, the problem of housing deficit in Nigeria continues to remain. This was reaffirmed by the results of this study, particularly that a large housing deficit still exists in Nigeria, and currently, there is no immediate prospect for improvement. Several interviewees also noted that this problem was probably more serious than officially reported, and that nothing significant of note was being done to address this issue. The results identified “lack of collaboration among stakeholders”, “corruption” and “greed” as the three main factors contributing to development of this situation. These results concur with the findings of L.M. Olayiwola and Adedokun (2014). Other major factors identified in this research as being influential to the housing problems in Nigeria were: “high cost of infrastructure”, “over reliance on imported material”, “over reliance on cement”, “inadequate Government policies”, “skills shortages” and “slow pace of construction”. The following subsections present details on each of these issues in groups representing the main themes of this study.

- **Financial issues**

Respondents identified financial issues as a major hindrance to effective housing delivery in Nigeria. The high cost of construction was one of the key factors, which concurs with results of Odunjo (2013). One of the most crucial issues highlighted here was the overheads ‘imposed’ due to lack of appropriate infrastructure. Another subset of cost is the high cost of getting title documents in Nigeria, which has a corresponding impact on the overall building cost. Other subsets contributing to the high cost of construction include the importation of building materials.

- **Construction sector related issues**

In terms of construction sector related issues, the lack of construction standards and poor professional ethics were identified as two main codes under “construction sector” related issues. This resonates with the findings of an earlier study by Solaja (2015) which examined ethics within the Nigerian construction industry. Similarly, it also reaffirms the findings of Oseghale et al. (2015) who argued that the use of unqualified professionals, lack of maintenance culture, poor quality materials and inadequate funds were some of the major causes of building failure in Nigeria. The fragmented nature of the construction industry was also identified as a major contributor to hindrance of housing delivery in Nigeria. This directly relates to knowledge management related factors raised by (Kamara et al., 2004). Other sub

categories identified under this theme included a reluctance to innovate and lack of investment and research.

- **Government related issues**

The last theme identified in this section was Government related issues. This theme referred to issues concerning the Government's role in supporting or hindering housing delivery at all levels. Quality shelter was seen as a basic need of mankind (L.M Olayiwola et al., 2005). Respondents observed that the Government had not been successful in providing this in Nigeria. Other codes highlighted under this theme were the inflation of contract prices, poor Government policies and lack of control on corrupt practices. The results revealed that these three areas tended to significantly affect housing delivery in Nigeria. It was also asserted by the interviewees that Nigeria needed a robust mortgage system to assure continuity of supply and demand within the construction industry. This also relates to poverty, as it affects the acquisition of housing ownership in Nigeria and the Government's role on housing policies and mortgage availability.

3.2 Potential benefits and prospects of promoting greater use of offsite manufacturing in Nigeria

Notwithstanding the potential benefits previously highlighted, the impact and propensity of OSM within Nigeria is somewhat parochial and limited. This is not the case in many other countries. For example, Kamar et al. (2009) noted that the Malaysian Government provided various initiatives to encourage OSM (e.g. the setting up of the Construction Industry Development Board). Other affirmative action includes: the UK (Buildoffsite, 2006); USA (J. S. Goulding et al., 2014); Australia (Blismas et al., 2010); and many other parts of the world. These sorts of initiatives have been influential for driving through 'change', which have positively impacted the market, improved quality, reduced waste, and improved overall efficiency within the AEC sectors. Given these opportunities, this study posits that the Nigerian context could also leverage these benefits. However, this will require conjoined effort of the Government and influential stakeholders to make this happen. OSM adoption could transform housing delivery in Nigeria. The issue of industry readiness and shortage of skills were seen as prerequisites; but these could equally be addressed by dedicated curricula and training programmes which focus specifically on Design for Manufacture and Assembly (DfMA), OSM, MMC, and associated innovative construction techniques.

Research findings also highlighted the need for research to be carried out on the various aspects of OSM with respect to people, process and technology – especially from an end user's perspective. This included local sourcing of materials and logistics to reduce the overall cost of construction and reduce carbon footprint. Similarly, Government awareness programmes could help underpin these initiatives through support mechanisms, subsidies and wider industry engagement programmes. This could be reinforced by engaging other stakeholders (e.g., real estate developers, mortgage institutions and professional bodies in the AEC industry), as they have key roles to play in the promotion of OSM in Nigeria. Finally, training and development was seen as the integral 'glue' which conjoins product to process. Awareness is a key challenge here. This involves collaboration and encouragement of research/practice, to purposefully showcase success stories, promote innovation, and create new supply chain relationships etc. (Figure 1).

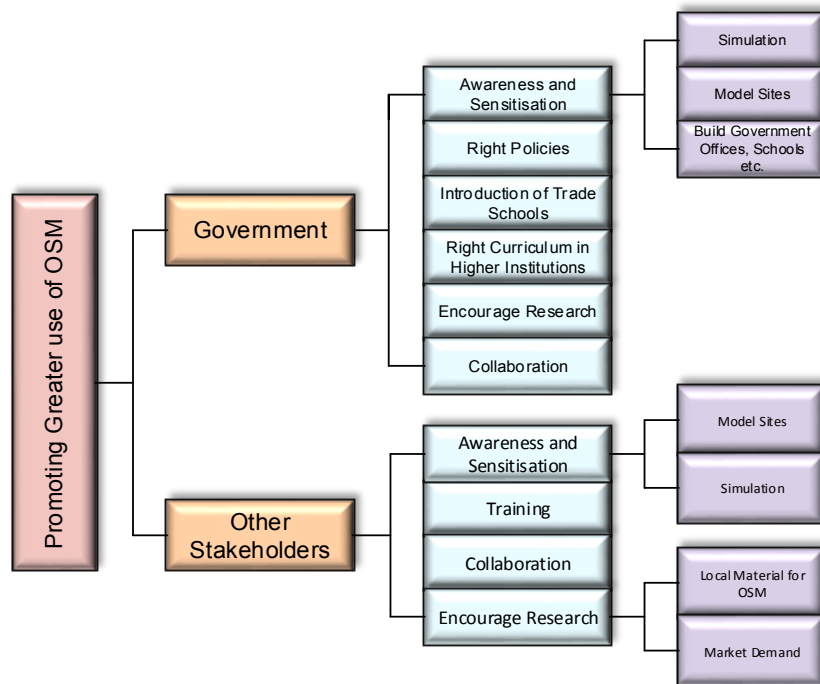

Figure 1: Major roles of Government and other stakeholders to promote OSM in Nigeria

3.3 Barriers to the use of offsite manufacturing in Nigeria

The lack of OSM presence in the Nigerian construction industry was seen as a major barrier. Critical mass is therefore needed. Part of the problem here is that OSM has not been formally (or informally) accepted as a viable delivery approach. Whilst OSM seemed to have a noticeable presence in Nigeria during the 1970s and 1980s, this gradually disappeared due to reduced demand for housing at that time, and reduced Government support. Anecdotally, respondents from this study noted that OSM and prefabrication was used in some civil engineering projects carried out by large construction firms in Nigeria, but not in the housing sector - which is heavily reliant on conventional brick/block construction. These challenges are not however unassailable – see (as per ascertained by M. Arif, 2012; Azman et al., 2010; PrefabNZ Incorporated, 2013). The real challenge for the successful adoption and uptake of OSM in Nigeria is a distinct need to identify the barriers (and priorities) that can hinder its adoption. In pursuance of this, three core themes (Pan et al., 2004) were identified as barriers to OSM adoption, namely: “human barriers”, “technical barriers” and “industrial barriers”.

- **Human barriers**

This theme covers barriers concerned with the stakeholders involved in the delivery of housing in Nigeria (including end-users). Previous studies highlighted negative perception on OSM as a major barrier for its adoption (e.g. M Arif et al., 2012a; Elnaas et al., 2014; Pan et al., 2004; PrefabNZ Incorporated, 2013); this was echoed by the respondents of this study. Other major codes identified under this category include: maintenance difficulties, client resistance, cultural issues and design flexibility.

- **Technical barriers**

Technical barriers refer to the barriers that can often hinder the construction process and the final product, i.e. a house. The main categories identified under this theme were lack of necessary infrastructure, lack of machinery, logistics and technical expertise. In terms of

Infrastructure development, respondents observed that Nigeria needed much better roads, transportation systems, and power grids in order to be able more able to adopt OSM. These results resonate with the results of a similar study by M Arif et al. (2012a), which identified infrastructure as a major challenge to OSM adoption in a similar context such as India.

• **Industrial barriers**

Industrial barriers included: the high cost of establishing factories; importation of materials; need for expatriate workers; and limitation of existing OSM factories as major barriers to OSM adoption in Nigeria. Although cost was identified as a major barrier, many respondents noted that some of the initial costs could be offset through areas such as: cost certainty; reduced risk; less overall life cycle costs due to better quality of products; reduced preliminaries and site overheads; and corresponding reduced construction time. This aligns to the findings of Gibb and Pendlebury (2006). Respondents also advocated that despite OSM being capital intensive, investment in OSM could be very beneficial for Nigeria, especially in the longer-term.

4. FUTURE DEVELOPMENT ROADMAP

Figure 2 presents a development roadmap based on the findings from this research. This roadmap summarises the motivations, success factors, and barriers associated with the adoption of OSM in Nigeria. This was initially developed from literature, and refined with the engagement of principal stakeholders from Nigeria. This roadmap is the first of its kind to specifically focus on: Barriers, Actions, Stakeholders and Goals (within the context of Nigeria). The barriers to OSM adoption in Nigeria were derived from expert opinions. This opinion included major stakeholders who had significant roles to play in OSM, and by default, any future actualisation of a roadmap of this nature. From this roadmap each barrier (green), mitigation actions (yellow), stakeholder involvement (purple), and goals (blue) are identified to deliver this roadmap.

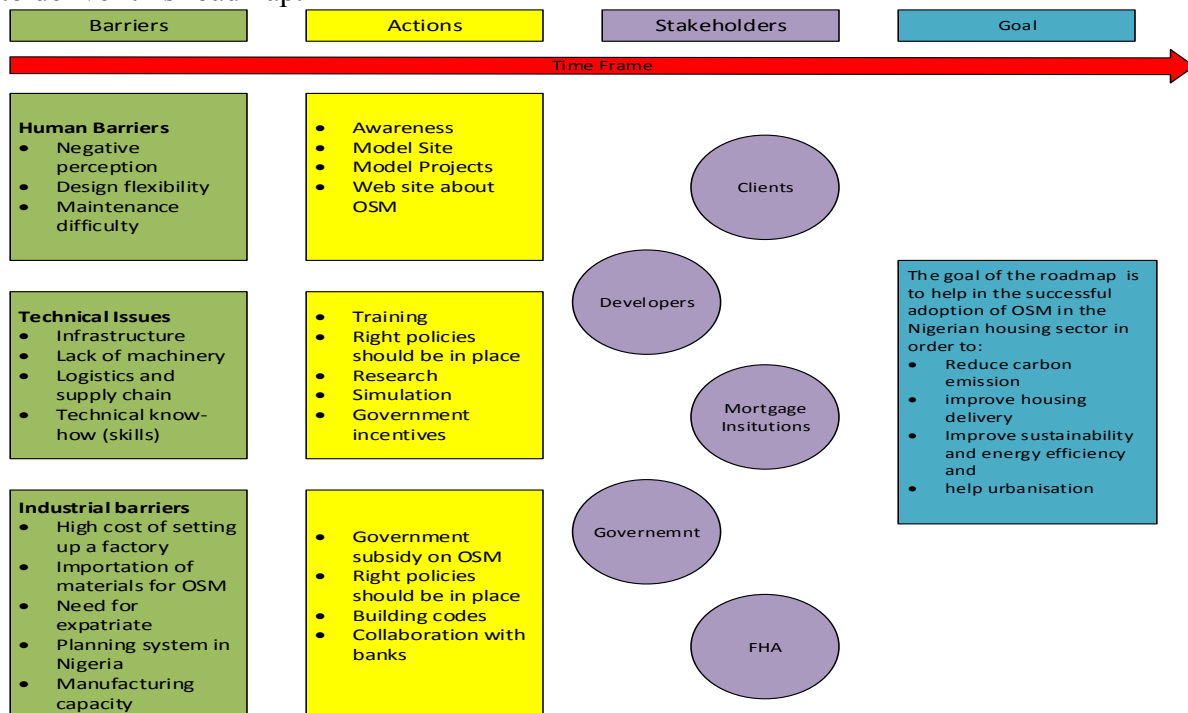

Figure 2: Outline Roadmap for the Adoption of Offsite Manufacturing in the Nigeria

5. CONCLUSION

Research findings indicate that whilst there is still a large housing deficit in Nigeria, there are currently no significant measures implemented to address this challenge. However, OSM has been proffered as a potential solution, particularly though its ability to meet volumetric delivery patterns with reduced costs and improved quality thresholds. That being said, contextual conditions need to be assessed before this can be considered a viable solution. In doing so, several barriers to OSM adoption were presented and discussed. Low-impact construction methods (such as OSM) are considered viable methods for both improving sustainability per se, but also feasible solutions for improving this housing deficit.

This study presented a series of underpinning steps needed to address the housing challenge, which included the concepts and possibility of OSM adoption in Nigeria. Whilst the context-specific OSM challenges presented in the outline roadmap highlighted barriers, actions, stakeholders involved and goals required, this research can only be considered the starting point for future studies. There is an exigent need to investigate these issues further, as it is important to proffer bespoke solutions to this environment e.g. infrastructure and local suitable materials for OSM. For this to be achieved, the experience garnered from other contexts need to be evaluated regarding their suitability and potential embeddedness.

The outline roadmap presented in this paper embeds the views and opinions of a number of high level stakeholders and respondents. This was needed to not only shape the boundaries (scope), but also focus on specific priorities and deliverables. For example, the barriers to OSM adoption in Nigeria are highly contextualised, multi-layered and complex. This roadmap is the first step in capturing these variables. It will however need to be refined and populated in more detail with specific, measurable, achievable, realistic and time-framed (SMART) objectives – so that clear priorities and directions can be established. Given this, from a generalisability and repeatability perspective, interpretation is confined, limited to the data set and context highlighted in this study.

6. REFERENCES

- Arif, M. (2012). Special Issue on Off-Site Construction. *Journal of Architectural Engineering*, 18(2), 67-68. doi:doi:10.1061/(ASCE)AE.1943-5568.0000090
- Arif, M., Bendi, D., Sawhney, A., & Iyer, K. C. (2012a). State of offsite construction in India-Drivers and barriers. *Journal of Physics: Conference Series*, 364(1), 012109.
- Arif, M., & Egbu, C. (2010). Making a Case for Offsite Construction in China. *Engineering Construction and Architectural Management*, 17(6).
- Arif, M., Goulding, J., & Rahimian, F. P. (2012b). Promoting off-site construction: Future challenges and opportunities. *Journal of Architectural Engineering*, 18(2), 75-78.
- Azman, M. N. A., Ahamad, M. S. S., Majid, T. A., & Hanafi, M. H. (2010). *Perspective of Malaysian Industrialized Building System on the Modern Method of Construction*. Paper presented at the 11th Asia Pacific Industrial Engineering and Management Systems Conference, Melaka, Malaysia. <http://www.apiems.net/archive/apiems2010/pdf/MM/427.pdf>
- Blismas, N., Wakefield, R., & Hauser, B. (2010). Concrete prefabricated housing via advances in systems technologies: Development of a technology roadmap. *Engineering, Construction and Architectural Management*, 17(1), 99 -110. doi:10.1108/09699981011011357
- Buildoffsite. (2006). Vision, Mission, Metrics & Goals. from Buildoffsite http://www.buildoffsite.com/market_strategy.pdf
- CERF. (1995). *National Construction Sector Goals: Industry Strategies for Implementation*. Retrieved from Washington D.C, USA: <http://fire.nist.gov/bfrlpubs/build95/PDF/b95068.pdf>

- Dada, A. (2013). Housing Deficit: Experts Canvass New Construction System, Newspaper. *The Punch*. Retrieved from <http://www.punchng.com/business/homes-property/housing-deficit-experts-canvass-new-construction-system/>
- DISR. (1999). *Building for Growth: An Analysis of the Australian Building and Construction Industries* (1999/041). Retrieved from Canberra, Australia: <http://www.tececo.com/files/sustainability%20documents/BuildingsForGrowth06122001.pdf>
- DPW. (1998). *Creating an Enabling Environment for Reconstruction, Growth and Development in the Construction Industry*. Retrieved from Pretoria, South Africa: [http://www.publicworks.gov.za/PDFs/documents/WhitePapers/White%20Paper-Reconstruction Growth and Development in the Construction Industry.pdf](http://www.publicworks.gov.za/PDFs/documents/WhitePapers/White%20Paper-Reconstruction%20Growth%20and%20Development%20in%20the%20Construction%20Industry.pdf)
- Egan, J. (1998). *Rethinking Construction: Report of the Construction Task Force* (1851120947). Retrieved from London, UK:
- Elnaas, H., Gidado, K., & Ashton, P. (2014). Factors and drivers effecting the decision of using off-site manufacturing (OSM) systems in house building industry. *Journal of Engineering, Project, and Production Management*, 4(1), 51 - 58.
- Femi, A. B., & Khan, T. H. (2014). Bridging the Gap between Housing Demand and Housing Supply in Nigerian Urban Centres: A Review of Government Intervention So Far. *British Journal of Arts and Social Sciences*, 18(2), 94-107.
- Gibb, A., & Pendlebury, M. (2006). Buildoffsite Glossary of Terms. from Buildoffsite http://www.buildoffsite.org/pdf/BuildoffsiteglossaryV1.3revised_july06.pdf
- Goulding, J. S., & Lou, E. C. W. (2013). E-readiness in construction: an incongruous paradigm of variables. *Architectural Engineering and Design Management*, 1-16. doi:10.1080/17452007.2013.775099
- Goulding, J. S., Pour Rahimian, F., Arif, M., & Sharp, M. D. (2014). New offsite production and business models in construction: priorities for the future research agenda. *Architectural Engineering and Design Management*, 11(3), 163-184. doi:10.1080/17452007.2014.891501
- Gu, N., & London, K. (2010). Understanding and facilitating BIM adoption in the AEC industry. *Automation in Construction*, 19(8), 988-999.
- Ibimilua, A. F., & Ibitoye, O. A. (2015). Housing Policy in Nigeria: An Overview. *American International Journal of Contemporary Research*, 5(2), 53-59.
- Kamar, K. A. M., Alshawi, M., Hamid, Z. A., Naw, M. N. M., Haron, A. T., & Abdullah, M. R. (2009). *Industrialised Building Systems (IBS): A Review of Experience in UK and Malaysia Construction Industry*. Paper presented at the 2nd Construction Industry Research Achievement International Conference (CIRAIC), Kuala Lumpur, Malaysia.
- Kamara, J. M., Augenbroe, G., Anumba, C. J., & Carrillo, P. M. (2004). Knowledge Management in the Architecture, Engineering and Construction Industry. *Construction Innovation*, 2(1), 63 -67. doi:10.1108/14714170210814685
- Kolo, S. J., Pour Rahimian, F., & Goulding, J. S. (2014). *Housing Delivery in Nigeria and the Opportunity for Offsite Manufacturing*. Paper presented at the Creative Construction Conference 2014, Prague, Czech Republic.
- Kumar, S., & Phrommathed, P. (2005). *Research methodology*: Springer.
- Latham, M. (1994). *Constructing the Team* (011752994X). Retrieved from London, UK: <http://www.cewales.org.uk/cew/wp-content/uploads/Constructing-the-team-The-Latham-Report.pdf>
- Makinde, O. O. (2014). Housing Delivery System, Need and Demand. *Environment, Development and Sustainability*, 16(1), 49 - 69. doi:10.1007/s10668-013-9474-9
- Mertens, D. M. (2015). *Research and Evaluation in Education and Psychology*. London, United Kingdom: SAGE Publications, Inc.
- Mullens, M. A., & Arif, M. (2006). Structural Insulated Panel: Impact on the Residential Construction Process. *Journal of Construction Engineering and Management (ASCE)*, 132 (7), 786-794.
- Nadim, W. (2012). Modern Methods of Construction. In A. Akintoye, J. Goulding, & G. Zawdie (Eds.), *Construction Innovation and Process Improvement* (pp. 209-233): Wiley-Blackwell.
- Nadim, W., & Goulding, J. S. (2010). Offsite Production: A Model for Building Down Barriers: A European Construction Industry Perspective. *Journal of Engineering, Construction and Architectural Management*, 18(1), 82-101.
- Ndarni, G. G., & Angbo, Y. B. (2014). Sustainable Housing for Poor People in Nigerian Urban Areas. *World Journal of Building Technology, and Estate Management*, 1(1), 6-9.
- Njoku, J., & Adegboye, K. (2015). Experts List Obstacles to Provision of Mass Housing. *Vanguard*. Retrieved from <http://www.vanguardngr.com/2015/06/experts-list-obstacles-to-provision-of-mass-housing/>
- Odujoko, O. O. (2013). *Laterite Building Material and Sustainable Housing Production in Nigeria*. Paper presented at the Sustainable Building and Construction Conference, Coventry University, Coventry, UK. http://www.irbnet.de/daten/iconda/CIB_DC26438.pdf

- Okonjo-Iweala, N. (2014). *Unleashing the Housing Sector in Nigeria and in Africa*. Paper presented at the 6th Global Housing Finance Conference, World Bank Headquarters, Washington DC, USA. http://www.housingfinanceafrica.org/wp-content/uploads/2014/06/6th_Global_Housing_Finance_CME_Keynote_Speech.pdf
- Olayiwola, L. M., & Adedokun, A. (2014). Housing Problems in Nigeria: The Way Forward. *Swiss Journal of Research in Business and Social Sciences*, 1(2), 27 - 41.
- Olayiwola, L. M., Adeleye, O., & Ogunshakin, L. (2005). *Public Housing Delivery In Nigeria: Problems And Challenges*. Paper presented at the World congress on Housing, Pretoria, South Africa. <http://repository.up.ac.za/bitstream/handle/2263/10438/Public%20Housing%20Delivery%20In%20Nigeria%20Problems%20And%20Challenges.pdf?sequence=1>
- Omotayo, T., & Keraminiyage, K. (2014). *The Widening Knowledge Gap in the Built Environment of Developed and Developing Nations: Lean and Offsite Construction in Nigeria and the UK*. Paper presented at the International Conference on Construction in a Changing World, Heritance Kandalama, Sri Lanka.
- Oseghale, G. E., Ikpo, I. J., & Ajayi, O. D. (2015). Causes and Effects of Building Collapse in Lagos State, Nigeria *Civil and Environmental Research*, 7(4), 34 - 43.
- Pan, W., Dainty, A. R. J., & Gibb, A. G. F. (2004). *Managing innovation: a focus on off-site production (osp) in the UK housebuilding industry*. Paper presented at the 20th Annual ARCOM Conference, Heriot Watt University, Edinburgh, Scotland
- PRB. (2014). 2014 World Population Data Sheet. In Population Reference Bureau (Ed.), World Population Data Sheet. Washington DC, USA: Population Reference Bureau. Retrieved from http://www.prb.org/pdf14/2014-world-population-data-sheet_eng.pdf.
- PrefabNZ Incorporated. (2013). *Prefab Roadmap: A Way Forward for Prefabrication in New Zealand (2013-2018)*. Retrieved from Wellington. New Zealand: <http://www.prefabnz.com/html/blob.php/Prefab%20Roadmap%20March%202013.pdf?attach=false&documentCode=6885>
- Rahim, M. S. M., & Haron, N. A. (2013). Construction Cost Comparison Between Conventional and Formwork System for Condominium Project. *International Journal of Advanced Studies in Computer Science and Engineering*, 2(5), 1 - 25.
- Rahimian, F. P., & Ibrahim, R. (2011). Impacts of VR 3D sketching on novice designers' spatial cognition in collaborative conceptual architectural design. *Design Studies*, 32(3), 255-291.
- Solaja, G. (2015). Tackling Corruption in the Construction Industry. *Nigerian Tribune*. Retrieved from <http://tribuneonlineng.com/tackling-corruption-in-the-construction-industry>
- Sommer, B., & Sommer, R. (1991). *A practical guide to behavioral research: Tools and techniques*: Oxford University Press.
- Taylor, S. (2009). *Offsite Production in the UK Construction Industry, A Brief Overview*. Retrieved from London: <http://www.buildoffsite.com>

W113: LAW AND DISPUTE RESOLUTION

THE LEGAL FORMATION, GOVERNANCE AND REGULATION OF INTERNATIONAL CONSTRUCTION PRODUCT SALES CONTRACTS: A CASE STUDY VIGNETTE

A. Agapiou

Department, of Architecture, University of Strathclyde, James Weir Building, Glasgow, G1 1XJ, Scotland

Email: andrew.agapiou@strath.ac.uk

Abstract: The traders in construction products and legal advisers require knowledge of the legal system that governs a particular contract; and whether the court or forum of a particular country has jurisdiction over the contract in question. Nevertheless, there is scant knowledge, awareness and analysis of the body of law that governs the trade in products associated with Construction Asset development. The aim of this case study vignette is to critically examine the application, governance and performance of the United Nations Convention on the International Sale of Goods (CISG) to agreement between a French-based enterprise and three other companies based in the USA, Ghana and Nigeria respectively for the sale of construction products. The paper will also scrutinise the extent to which the provisions of the CISG apply or otherwise in circumstances where disputes might arise between the contracting parties. This paper has examined key aspect of private international law, focussing primarily on jurisdiction, recognition and enforcement and choice of law under the CISG, drawing on case study analysis of a construction product sales transaction. The paper demonstrates the need for traders and lawyers to have a comprehensive understanding of the problems of conflict of laws in transnational commerce and how they may be addressed in an international setting.

Keywords: Construction Product Sales Contracts, Governing Law, UN Convention

1. INTRODUCTION

The objective of the paper is to examine the nature of the contractual relationship between the parties, including the extent to which the relationship is governed by the UN convention (CISG) and other rules regulating international trade and the extent to which the provisions of the convention could be applied in circumstances where disputes may arise between the contracting parties. Four firms are parties to the contract. Two of the companies located in states that are members of the UN convention, France and the USA. One of the parties is based in a state that has a civil law legal system (Ghana); the other is in a state which has a common law legal system (Nigeria). The case study is structure around the following main questions:

- What law will govern this contract? Can the parties agree that CISG will govern the relationship?
- The contract involves the sale of goods (including parts and assembled products) as well as the supply of services. Can the CISG regulate the entire contract? If not, hat parts?
- In the event that the parties agree that CISG will be the governing law, what aspects of the contract will be governed nevertheless by local law
- If the parties agree that the CISG will be the governing law, how will the provisions of the CISG be interpreted in the vet there is some dispute about their meaning? If some provisions of the contract is unclear, how will it be interpreted?

- What criteria will be used to determine if a party has breached? If a party does breach, can the other parties avoid their obligations to perform? Can all of the provisions of the contract – including the choice of law clause – be avoided?
- If a party fails to perform, can a court intervene and order the party to perform? Are there any limits on what a court may order a party to do?
- What duty does a party have to keep damages caused by another party's breach to a minimum? What excuses are available for a breaching party to justify non-performance?

2. THE GOVERNANCE OF THE CONTRACTUAL RELATIONSHIP

We are told that there are four parties to the contract and that it involves the sale of goods as well as the supply of services. There is, however, no mention of the nature of the relationship between the parties. Indeed, what is the buyer-seller relationship between the parties? Let us presume that the French-based subsidiary is the provider of construction products for the purposes of illustration. The principles of the CISG are well-understood by legal scholars and practitioners as the basis for governing international sales trade (Gabriel, 1994), but do the rules apply in all circumstances?

According to Carr (1999);

'The CISG does not apply to all international sales contracts. Each agreement must be examined with reference to four important qualifications to its operation' (Carr, 1999)

What exactly are these four qualifications? According to Klotz (1997) the assessment must be based on firstly, whether the parties are in CISG contracting states; secondly, whether the contract is for the sale of commercial goods; thirdly whether materials and services also being provided within the agreement; and finally, whether the CISG covers only matters at hand. Let us now examine the agreement between the four parties against the above criteria. We know that of the four parties to the agreement only two are based in CISG signatory states; one in France and the other in the US. Does this mean that the Convention cannot govern the agreement? Not necessarily. We know that under Article 1 (1) (a) if both parties' place of business are within countries that have adopted the Convention, then the rules of CISG would apply to the contract. In our case, only two of the four parties have a place of business in signatory countries. Could the CISG still apply to the agreement between the parties? The answer is potentially, yes (1). If, on one hand, we presume that the contract between the parties is governed by French international law, then CISG would apply to the agreement unless of course the parties have explicitly expressed otherwise within the contract itself; under Article 1(1) (a). On the other hand, if the law of Nigeria or Ghana governed the contract, then CISG would not apply under the rules of the Convention. What about if the law of the US applied to the agreement between the parties? We know that the US is a signatory to the Convention (Amandpour, 2005), but does this provision apply in all circumstances? It would seem not as the US has explicitly excluded the provision of Article 1(1) (b) of CISG under an Article 95 declaration (Lookofsky, 2004).

2.1 The regulation of the contractual relationship under CISG

Let us now consider whether the contract is for the sale of commercial goods. We know that the Convention does not apply to the sale of all goods (2). Goods bought for personal, family

and household goods are excluded under Article 2(a), as are sales by auction, ships, and aircraft. We do not know exactly what the goods are in our scenario. According to Crawford (1988) it would be wise to be specific about the nature of the goods for sale when drafting the contract.

We are told that the contract involves the sale of goods (including parts and assembled products) as well as the supply of services. It is unclear whether the CISG would apply in our scenario as regulated by Article 3(1) of the Convention. How much of the goods have the buyers undertaken to supply necessary for manufacture and production, if at all? Is the obligation of the seller, say the French-based subsidiary, to provide *mainly* services for the manufacture of the product (s)?

We know that under Article 3(2), this type of provision would be disqualified from CISG application. We would need to establish, as Klotz (1997) describes it '*whether the total price of the goods sold exceeds the total price of the installation services*'. It may be necessary for the *services* provision to be excluded from the agreement. In other words, CISG would be able to regulate a mixed transaction of the sale of goods and services, only if the services-element did not constitute a *preponderant* part of the contract. Perhaps, the contract is for the supply of goods to be manufactured? If this was the case then the Convention would apply to the contract in our scenario (Bernstein and Lookofsky, 2003). Let us assume that the contract between the parties is governed by the Convention. Does the CISG cover all aspects of the agreement? What matters are governed by local laws? According to Article 4 the rules only govern... *the formation of the contract of sale and the rights and obligations of the seller and the buyer arising from such a contract. In particular, except as otherwise expressly provided in this Convention.....*

The wording in Article 4, nevertheless, would seem to point to a number of exemptions. Indeed, there would appear to be situations where the CISG does deal with matters of validity, as for example in Articles 11 and 29 of the Convention that deal with the provisos covering contracts evidence in writing and modifications to agreements respectively. Nevertheless and in light of the foregoing, it would seem that the Convention is generally not concerned with validity. The courts would therefore have to resolve matters relating fraud, duress, mistake, reasonableness of contract terms in accordance with domestic rules of law. According to Klotz (1997) there are 2 further matters at hand apart from validity that would not be governed by the CISG. Under Article 4 (b), the convention is not concerned with the '*effect which the contract may have on property in the goods sold*', nor the '*liability of the seller for death or personal injury caused by the goods to any person*' under Article 5. In our scenario, the parties would need to state which law governed these matters in the agreement. The rules of private international law would probably apply in this situation and would have to be resolved through French domestic law. Let us suppose that parties have agreed that the convention will govern the contract how then would the provisions of CISG be interpreted in the event there is a dispute about their meaning? We would need to look to Article 8 for guidance on these matters (3). It would seem that there are both objective and subjective tests in respect to the statement and conduct of parties as regards to the application of Article 8 (Zeller, 2002).

The application of Article 8(1) seems to point to a subjective test of one party's statements and conduct, whereby the other party knew or could not be completely unaware of the first party's intention. In contrast, Article 8 (2) seems to impose an objective test to statements of one party in which the other party neither, as Bernstein et al (2003) describes it, '*knew nor could have been aware of the intent, subject to the understanding of a reasonable person in the same circumstances would have had*'(Bernstein and Lookofsky, 2003).

3. GOVERNANCE UNDER CISG AND THE RESOLUTION OF DISPUTES

In our case, where there are disputes about the meaning of some of the provisions of the Convention, then their interpretation will be governed by Article 8, accepting that there may be situations where the courts may need to refer to domestic law in matters relating to the validity of the contract (as above), such as for example, disclaimers that limit or exclude liability (Ziegel, 1981).

3.1 Offer, acceptance and written provisions

According to Schlechtriem (1998) the Convention is divided into three parts, Parts I, II and III. A cursory examination of the text reveals that Part I focuses on the application of the Convention, Part II on the formation of the contract and Part III on the rights and obligations of the different parties to a contract. We know that a contract involves the creation of a legal relationship between parties (Turner, 2003). We also know that contracts can be made orally, in writing or implied in conduct. There would seem to be no formal requirement for either intentions, under Article, 11 (4), the sales contract itself under neither Article 13 (5) nor contract modifications under Article 29 (6) to be in writing. Nevertheless, if the specific contract points to a modification being in writing, then this requirement is binding on the parties under Article 29(2). The need for formal writing requirements also seems to be the case a number of countries in which the requirement is a matter under their own domestic law. This requirement is covered by Article 96. According to Lookofsky (2004) an offer to buy or sale goods must meet minimum requirements under the CISG. The precise details of these minimum requirements are covered in Article 14 (7). It would seem that the offer be addressed to *specific person(s)*, but that it must also be *sufficiently definite, as well as the intention of the offeror to be bound*. It would seem that there must be a clear definition of goods involved and implicitly or expressly how the quantity and price of goods are fixed (8).

Let us assume that, in our case, when would the offer take effect? More specifically if one of the parties makes an offer and promises to keep it open for a period of 30 days; can it change its mind and withdraw the offer? The issue of when an offer becomes effective is covered under Article 15. It would certainly seem that an offer becomes effective when it reaches offeree and that the offer can be withdrawn at any point up *'before or at the same time as the acceptance'*. In our case, we are told that one party makes an offer and promises to keep it open for a period of 30 days. If it were a written offer then according to Bernstein et al (2003), it would take effective as soon as it reaches the offeree place of business. In these circumstances it would then not be possible for the offer to be revoked. What however, if the offer was never effective under the Convention? Can it be withdrawn under these circumstances? It would seem that under the French Civil Code, most relevant to our situation, that an offer, once communicated remains binding for a reasonable time (Murray, 1998). Is 30 days a reasonable time? Article 16 would seem to capture the essence of the former point. It would also seem, in our case, that the party has made an irrevocable statement in regards to the offer. That being the promise to *'keep it open for a period of 30 days'*.

Under the rules of the Convention such an offer cannot be revoked during that period, even if the party had changed its mind during that time. Let us now focus on the issue of acceptance. When does an acceptance become effective? Matters concerning acceptance of an offer are covered under Articles 18-22 (Schlechtriem, 1998). Under Article 19 for an acceptance becomes effective, then it must match the terms of the offer (10). As regards whether a *'call for minor*

changes or modification to terms of an offer' would represented a counter-offer rather than an acceptance, it would seem that as long as the as the 'purported acceptance', as Lookofsky (2004) describes it, does not materially affect the terms of the offer then it would still constitute an acceptance. This point is reflected in Articles 19(2) and (3) (11).

3.2 Performance obligation and breach

It seems fairly clear that the seller is required to deliver the right good and documents at the right time in accordance with the terms of the contract. All these obligations would seem to be covered by Articles 31-34 (Schlechtriem, 1998). There would seem to be rules under these particular Articles that govern default situations in which the contracts are silent the place and the timing of deliveries. It seems that if the contract is silent on where the seller should deliver the goods, for a contract providing carriage (i.e., requires the seller to hand the goods over to a third-party carrier for transmission to the buyer), Article 31 (a) requires delivery to the carrier. If however, the contract does not involve carriage, the place for delivery 'is the place where the goods are to be manufactured or to be drawn from specific stock (if so indicated in the contract) or otherwise at the place where the seller had its place of business when the parties contracted', under Article 31 (b). Article 31 (c) would seem to provide a fall-back position, not covered by either Article 31 (a) or (b). In this case, the seller is required to '*place the goods at the buyers' disposal at the place where the buyer had his business at the conclusion of the contract*'.

The obligation of the seller to deliver the appropriate documents in respect of the goods is another matter governed by the Convention. This obligation would seem to be covered by Article 34 of the CISG (12). There would not seem to be a 'backstop' provision, unlike the situation governing the delivery of goods; the time, place and form of delivery of documents are not governed by the provision of the Convention. How would a court act if a dispute arose in respect to this matter? Would there be any need to interpret the intentions of the parties? In all likelihood, yes, through prior dealings and trade customs, under Article 9 of CISG (Patrick, 1998). Nevertheless, this approach does not cover all issues concerning documentation. What about documents of title concerning the goods? We know that the seller is required to transfer the goods to the buyer as regulated by Article 30, but that all matters concerning the transfer are not governed by the Convention is highlighted in Article 4. The rules governing private international law would govern this matter (Ferrari, 2005). So far we have focused on the place of delivery, what about the timing of delivery? How is this dealt with under the Convention? The timing issues would seem to be covered by Article 34 (13). In our case where the contract is silent, then it would seem that delivery should take place within a reasonable time. What is a reasonable time? This, we know, is a question of fact and a matter to be determined taking all circumstances in account relating to the contract. Let us now consider some of the buyer's obligations under the Convention. Notably, when must the buyer make payment? What must a buyer do to reject non-conforming goods? At what point do buyers become liable for any accidental loss or damage suffered by the goods?

3.3 Breach, damages and non-performance

It seems fairly clear that the obligations of the buyer under the Convention are to pay the price, and to take delivery of the goods. In terms of the buyer's obligation to pay the price, the Convention states that '*the buyer must pay the price on the date fixed by or determinable*

from the contract and the Convention, irrespective of whether the seller has requested payment or not, as governed by Article 59. Having considered the matter of payment how about if the buyer had decided to reject non-conforming goods? What is the procedure under these circumstances?

While it seems that under Articles 35-37 the seller is required to deliver goods that conform to the contract, under Article 38, *'the buyer would be under an obligation to examine the goods as soon as practicable and notify the seller of any lack of conformity within a reasonable time after a defect has been discovered, or at the latest, within two years of delivery. Failure to conduct this examination or make the complaint forfeits the buyer's right to reject the goods and, more significantly, the right to claim damages or a price reduction'*, (14) as governed by Article 39. Again, under Article 38, what exactly is a reasonable time is question of fact and circumstances surrounding the transaction. Clearly, the loss of goods can occur for whatever reason at any point during transit, at the time of delivery and after delivery (Bund, 2004). Which of the parties should bear this loss? The Buyer or the Seller? At what point will the buyer become liable for any loss or damage suffered by the goods? It is probably safe to assume that this would be at time of delivery, but does this notion apply to all circumstances? If the Convention applies to an agreement, then the matter is regulated by Article 67 (15).

What if the goods are already in transit? Who would be liable in these circumstances? It would seem, under Article 68, that the risk of loss passes to the buyer at the point where the agreement was concluded, otherwise at the time when the goods were transferred to the carrier. It is noteworthy that once the risk has passed to the buyer, the discharge of any responsibility to pay the price for the goods, in the event of any loss or damage to the goods, is not possible unless of course the loss and damage was due to any act or omission of the part of the seller, as governed by Article 68. All contracts are concerned with rights and obligations of parties to an agreement. In circumstances where one party fails to perform an obligation arising under a contract then the party we can say that the party is in breach of contract (Turner, 2003). Part III of the Convention focuses on both the obligation of the seller and buyer, as well as remedies for either party in circumstances where there is a breach of contract (Schlechtriem, 1998).

Under Article 30, the seller is under the obligation to *'deliver the goods, hand over any documents relating to them and transfer the property in the goods.'* He must do so *"within a reasonable time after the conclusion of the contract"*, under Article 33 (c). If a date or a period of time is fixed the delivery must take place *'on that date'*, under Article 33 (a) or *'within that period'* under Article 33 (b). Under Article 35, the seller is required *'to deliver goods 'which are of the quantity, quality and description required by the contract and which are contained or packaged in the manner required by the contract'*. In particular the goods must be fit for the ordinary or particular purpose known to the seller, under Article 35(2) (a) (b); possess the quality of a sample or model held out to the buyer, under Article 35(2) (c); and be contained in a usual manner or adequate to protect and preserve the goods Article 35(2) (d). According to von Caemmerer et al (1995) if the seller does not comply with one of the above requirements then they are in breach of the contract. What about the buyer's obligations? The buyer would seem to have certain obligations under Article 53, the most important being *'pay the price for the goods and take delivery of them'*. According to Lee (1993) if the buyer fails to do so he is in breach of contract (Lee, 1993). So what would happen if one party, either seller or buyer, does breach the contract? Can the other party avoid their obligation to perform in these circumstances? According to Magnus (2000) *'a simple breach of contract does not entitle the*

aggrieved party to avoid the contract' (16). Under the Convention, avoidance can only be granted in specific circumstance and is regulated by a number of Articles.

Primarily the breach must be fundamental as regulated by Article 25. Under Article 49 of the Convention the buyer may declare the contract avoided if the seller fails to perform his obligations. It would also seem that the same principle applies to the seller under Article 64. Article 72 points to avoidance where it is clear that and almost certain that either the seller or the buyer will fundamentally breach the contract. Article, 73 covers avoidance of the contract as a whole where the fundamental breach concerns the whole contract. It is worth noting at this point that there is a general duty on all parties relying on breach under Article 77 to take reasonable measures to mitigate the loss, otherwise the party in breach may claim a reduction in the damages in the amount by which the loss should have been mitigated. Seemingly, under Article 81 once a contract has been declared avoided, 'the contract is terminated and the parties are released from their obligations for the future'. This would mean that the buyer would lose the right to claim the delivery of goods and the seller cannot claim payment of the price anymore. Nevertheless, according to Bianca et al (1987) the aggrieved party would not lose the right to claim damages suffered as a consequence of the breach. Under Article 81 (2), '*a party who has performed the contract either wholly or in part may claim restitution from the other party of whatever the first party has supplied or paid under the contract.*' It is clear from the foregoing that the primary effect of the avoidance of the contract by one party is the release of both parties from their obligations under the contract. That being the seller need not deliver the goods and the buyer need not take delivery or pay for them. Does this mean that all of the provisions of the contract, including the choice of law, can be avoided? Article 81 (1) states that '*Avoidance does not affect any other provision of the contract governing the rights and obligations of the parties consequent upon the avoidance of the contract*'. This would seem to cover the choice of law provision within the contract (17).

According to Starzmann (2006) '*specific performance is recognized as a prior remedy except where the performance has become impossible or illegal in civil law jurisdictions*'. In which case would it not appear unreasonable to grant specific performance, for example, in the case where the costs to make performance possible would be higher than the value of the goods sold? The extent to which a court can intervene and order a party to perform is covered under Article 28. Moreover, if the seller does not perform one of his obligations under the contract of sale or this Convention, the buyer may require performance by the seller as regulated by Article 46. It would also seem that Article 62 empowers the seller to require the buyer to pay the price, take delivery or perform his other obligations. In what circumstances can the aggrieved party obtain the aid of a court to enforce the obligation of the party in default to perform the contract? Article 28 does not authorises a court to be bound to enter a judgment providing for specific performance, except where it would be possible for a court to do so under domestic law in respect to similar contract not governed by CISG (18). Does this mean that Article 28 supersedes the application of Article 46 or 62? The answer is no. Article 28 limits, as the UN Secretariat describes it, '*their application only if a court could not under any circumstances order such a form of specific performance*' (19).

How about if the buyer had decided to reject non-conforming goods? What is the procedure under these circumstances? While it seems that under Articles 35-37 the seller is required to deliver goods that conform to the contract, under Article 38 of the Convention, the buyer would be under an obligation '*to examine the goods as soon as practicable and notify the seller of any lack of conformity within a reasonable time after a defect has been discovered, or at the latest, within two years of delivery*'. Failure to examine the goods or make a complaint would forfeits

the buyer's right to reject the goods and, more specifically, the right to claim damages or a price reduction as governed by Article 39 (Honnold, 1999).

The Convention makes a number of remedies available to parties in the event of a breach. Clearly, Avoidance and specific performance are two notable, remedial options, but what about damages for breach of contract? Does avoidance or specific performance preclude parties from seeking damages? It would seem that Article 45(2) that the buyer is not forced to elect between claiming damages and exercising the other remedies conferred on him under the convention, that being specific performance and avoidance. This would seem to align with common law positions (20). In other words that '*a buyer who rejects non-conforming goods or cancels the contract on some other ground is not thereby deprived of his entitlement to damages*' (21). Moreover, it would seem under Article 74 that a buyer who requires the seller to perform, under Article 46, may also recover *damages 'for the loss resulting from the delay or other deficiency in the seller's performance'*. The seller's right to damages is protected by Article 61(2) which parallels Article 45(2).

4. CONCLUSIONS

The UN Convention on contracts for the International Sale of Goods 1980 is the result of over 50 years of negotiations at international level. It is an attempt to harmonise the law of international sale of goods between civil and common law practices. The primary aim of this case study vignette was illustrative; to scrutinise the body of law that would govern the trade of construction goods and services between a French-based subsidiary and three other companies based in the US, Ghana and Nigeria respectively. The case study serves as an example to traders in construction products and legal advisers how the body of law that would govern the trade of construction goods and services between contracting parties based in various civil and common law jurisdictions. In this case, we know that that France and the US are contracting states to the CISG. On the other hand we know that, Ghana and Nigeria are not signatories to the Convention. There is little to indicate, notwithstanding the latter, that the provisions of the CISG do not apply to the transaction; pointing thereby to the application of the Law of France and the provisions therein to the contractual relationship.

5. REFERENCES

Cases

Filanto S.p.A. v. Chilewich Int'l Corp

Heuze, Vente Internationale no. 118.

Oberlandesgericht Koln, 19 U 282/93; Recht der Internationalen Wirtschaft (RIW) 1994, 970;

Supreme Court of Austria Parties Unknown, (27 October 1994) 8 Ob 509/93 (Germany); Zeitschrift für Rechtsvergleichung 1995, 159; Case 105, Case Law on UNCITRAL Texts (CLOUT), United Nations.

Publications

Ahmadpour, A (2005) Economic hardship in performance of contracts: A comparative study of English, American, French and German law and the CISG, the UNIDROIT Principles and PECL Thesis (Ph.D.) University of Aberdeen

Bernstein, H and Lookofsky, J (2003) Understanding the CISG in Europe, 2nd Edition, Kluwer Law International, The Hague

Bianca, C.M. and Bonell, M.J (1987) "Commentary on the International Sales Law - The 1980 Vienna Sales Convention", Milan, at Article 74, 2.2

Carr, I (1999) Principles of international trade law 2nd edition, Cavendish Publishing Limited, London

- Crawford, B (1998) Drafting considerations under the 1980 United Nations convention on contracts for the international sale of goods, *Journal of Law and Commerce*, 8, 187-205
- Ferrari, F (2005) What Sources of Law for Contracts for the International Sale of Goods? Why One Has to Look Beyond the CISG, *International Review of Law and Economics*, 25, September, 328-330
- Gabriel, H (1994) Practitioner's guide to the Convention on Contracts for the International Sale of Goods (CISG) and the Uniform Commercial Code (UCC) Oceana Publications, Inc
- Honnold, J.O (1999) *Uniform Law for International Sales under the 1980 United Nations Convention*, 3rd ed., Kluwer Law International, The Hague.
- Lee, R (1993) The UN Convention on Contracts for the International Sale of Goods: OK for the UK? *Journal of Business Law*
- Lookofsky, J (2004) *Understanding the CISG in the USA*, 2nd Edition, Kluwer Law International, The Hague
- Lookosky, J (2000) Article 45 Remedies for Breach of Contract by the Seller, in *International Encyclopaedia of Laws - Contracts*, J. Herbots and R. Blanpain (eds), Suppl. 29, December, 1-192.
- Schlechtriem, P (1998) *Commentary on the UN Convention on the International Sale of Goods*, 2nd Edition, Clarendon Press, Oxford
- Turner, C (2003) *Contract Law*, Hodder and Stoughton, Oxford
- Von Caemmerer, E. and Schlechtriem, P (1995) "Kommentar zum Einheitlichen UN-Kaufrecht", 2nd edition, Munich, at Article 25 - 7
- Zeller, B (2002) Determining the Contractual Intent of Parties under the CISG and the Common Law - A Comparative Analysis, *European Journal of Law Reform* (4/2002) 629-643

Internet Resources

- Patrick X. Bout (Netherlands), Article 9 of the Convention on Contracts for the International Sale of Goods, Pace paper (1998) available at <http://www.cisg.law.pace.edu/cisg/biblio/bout.html>
- Brandner, Gert, University of Aberdeen September 1999: Admissibility of Analogy in Gap-filling under the CISG. Published on the internet at <http://www.cisg.law.pace.edu/cisg/biblio/brandner.html>
- Bund, Jennifer M.: Force majeure Clauses: Drafting Advice for the CISG Practitioner. Published on the internet at <http://www.cisg.law.pace.edu/cisg/biblio/bund.html>
- Fritz Enderlein (Germany (DDR)), Rights and Obligations of the Seller under the UN Convention on Contracts for the International Sale of Goods (General obligations: Art. 30), in Sarcevic / Volken ed., *International Sale of Goods: Dubrovnik Lectures*, Oceana (1996) at 198-199; available at <http://www.cisg.law.pace.edu/cisg/biblio/enderlein1.html>
- Klotz, J(1997)Critical Review of the ICC Model International Sale Contract (Review of a "Model" contract whose clauses have been prepared based on the assumption that the contract is governed by the CISG), CISG W3 Database, Pace University School of Law (<http://www.cisg.law.pace.edu>) November 1997, pp 1-8
- The remedy of avoidance of contract under cisg—general remarks and special cases, *Ulrich Magnus, Hamburg*; available at www.uncitral.org/pdf/english/CISG25/Magnus.pdf
- Secretariat Commentary on article 28 of the UN Convention; available at www.cisg.law.pace.edu/cisg/text/secomm/secomm-28.html
- Starzmann, K (2006) The relationship between the use of the Unidroit Principles and the CISG in a comparative view and how the Unidroit Principles contribute to the interpretation of the CISG, Unpublished Research Dissertation for LL.M programme, University of Cape Town, available at http://www.lawspace.law.uct.ac.za:8080/dspace/bitstream/2165/299/1/StarzmannK_2006.pdf
- Report to the Uniform Law Conference of Canada on Convention on Contracts for the International Sale of Goods, Professor Jacob S. Ziegel, University of Toronto, July 1981 and available at <http://www.cisg.law.pace.edu/cisg/text/ziegel8.html>

6. FOOTNOTES

- (1) Under Article 1(1)(b) of the Convention the rules can extend to 'contracts for the sale of goods between parties whose places of business are in different States ... when the rules of private international law lead to the application of the law of a Contracting State'.
- (2) see Oberlandesgericht Köln, 19 U 282/93; *Recht der Internationalen Wirtschaft (RIW)* 1994, 970;
- (3) Article 8 (1) & (2) states that ('1) For the purposes of this Convention statements made by and other conduct of a party are to be interpreted according to his intent where the other party knew or could not have been unaware what that intent was. (i) If the preceding paragraph is not applicable, statements made by and other conduct of a party are to be interpreted according to the understanding that a reasonable person of the same kind as the other party would have had in the same circumstances'

- (4) Article 11 states: *'A contract of sale need not be concluded in or evidenced by writing and is not subject to any other requirement as to form. It may be proved by any means, including witnesses'*.
- (5) Article 13 states: *'For the purposes of this Convention "writing" includes telegram and telex'*
- (6) Article 29 states: *'(1) A contract may be modified or terminated by the mere agreement of the parties. (2) A contract in writing which contains a provision requiring any modification or termination by agreement to be in writing may not be otherwise modified or terminated by agreement. However, a party may be precluded by his conduct from asserting such a provision to the extent that the other party has relied on that conduct'*
- (7) Article 14 states *(1) A proposal for concluding a contract addressed to one or more specific persons constitutes an offer if it is sufficiently definite and indicates the intention of the offeror to be bound in case of acceptance. A proposal is sufficiently definite if it indicates the goods and expressly or implicitly fixes or makes provision for determining the quantity and the price.*
(2) A proposal other than one addressed to one or more specific persons is to be considered merely as an invitation to make offers, unless the contrary is clearly indicated by the person making the proposal.
- (8) Article 15 states *(1) 'An offer becomes effective when it reaches the offeree.*
(2) An offer, even if it is irrevocable, may be withdrawn if the withdrawal reaches the offeree before or at the same time as the offer.
- (9) Article 16 states: *'(1) until a contract is concluded an offer may be revoked if the revocation reaches the offeree before he has dispatched an acceptance.*
(2) However, an offer cannot be revoked: if it indicates, whether by stating a fixed time for acceptance or otherwise, that its irrevocable; or if it was reasonable for the offeree to rely on the offer as being irrevocable and the offeree has acted in reliance on the offer'
- (10) Article 19(1) states: *'(1) A reply to an offer which purports to be an acceptance but contains additions, limitations or other modifications is a rejection of the offer and constitutes a counteroffer'.*
- (11) Articles 19(2) and (3) of the Convention states: *'(2) However, a reply to an offer which purports to be an acceptance but contains additional or different terms which do not materially alter the terms of the offer constitutes an acceptance, unless the offeror, without undue delay, objects orally to the discrepancy or dispatches a notice to that effect. If he does not so object, the terms of the contract are the terms of the offer with the modifications contained in the acceptance.*
(3) Additional or different terms relating, among other things, to the price, payment, quality and quantity of the goods, place and time of delivery, extent of one party's liability to the other or the settlement of disputes are considered to alter the terms of the offer materially'.
- (12) The first sentence of Article 34 states: *'If the seller is bound to hand over documents relating to the goods, he must hand them over at the time and place and in the form required by the contract'*.
- (13) Article 34 states *'The seller must deliver the goods: (a) if a date is fixed by or determinable from the contract, on that date;*
(b) if a period of time is fixed by or determinable from the contract, at any time within that period unless circumstances indicate that the buyer is to choose a date; or
(c) in any other case, within a reasonable time after the conclusion of the contract'
- (14) <http://www.cisg.law.pace.edu/cisg/biblio/lorenz.html>
- (15) Article 67 states:..... the risk passes to the buyer when the goods are handed over to the first carrier for transmission to the buyer in accordance with the contract of sale'
- (16) The remedy of avoidance of contract under CISG—general remarks and special cases, *Ulrich Magnus, Hamburg; available at www.uncitral.org/pdf/english/CISG25/Magnus.pdf*
- (17) See for example, the decision of the United States District Court for the Southern District of New York in *Filanto S.p.A. v. Chilewich Int'l Corp.*, for an analysis of the point.
- (18) Article 28 states *'If, in accordance with the provisions of this Convention, one party is entitled to require performance of any obligation by the other party, a court is not bound to enter a judgement for specific performance unless the court would do so under its own law in respect of similar contracts of sale not governed by this Convention'.*
- (19) Fritz Enderlein (Germany (DDR)), Rights and Obligations of the Seller under the UN Convention on Contracts for the International Sale of Goods (General obligations: Art. 30), in Sarcevic / Volken ed., *International Sale of Goods: Dubrovnik Lectures*, Oceana (1996) at 198-199; available at <http://www.cisg.law.pace.edu/cisg/biblio/enderlein1.html>
- (20) According to Lookofsky (2000) *'under some domestic legal systems, a (serious) delay in delivery does not necessarily give the buyer the right to avoid the contract, in that the seller may apply to a court for a delay of grace (délai de grâce) which - if granted - effectively establishes a new delivery date. Under the Convention, however, the buyer's right to avoid for fundamental breach cannot be defeated by such a délai de grace. Indeed, Article 45(3) expressly provides that no period of grace may be granted to the seller by a court or arbitral tribunal when the buyer resorts to any remedy for breach of contract'*.
- (21) <http://www.cisg.law.pace.edu/cisg/text/anno-art-45.html>

COLLABORATIVE BUSINESS RELATIONSHIPS: A MEANS TO AN END OF CONSTRUCTION DISPUTES OR FUEL FOR THE FIRE?

A. Agapiou and Z. Chen

Department, of Architecture, University of Strathclyde, James Weir Building, Glasgow, G1 1XJ, Scotland

Email: andrew.agapiou@strath.ac.uk

Abstract: Collaboration under BS11000 provides an opportunity for clients, designers, contractors and other parties to construction projects to come together from a very early stage and form relationships in advance of any actual physical work being carried out on site. With the introduction of a standard for collaborative business relationships which defines the processes, this paper aims to investigate how contractual relationships can be supported by building a collaborative working relationship underpinned by BS11000 and, if, by building these relationships, disputes that would traditionally arise out of construction contracts can be resolved between the parties before they become a dispute or whether the parties to a construction contract are lulled into a false sense of security where they are more relaxed in the relationship, failing to take due cognisance of the terms and conditions of the contract until a dispute has crystallised and they find that the required supporting information is not available. The findings of the investigation indicate that for collaborative relationships to be successful under the BS11000 standard, the Relationship Management Plan (RMP) plays a significant role in the process of preventing issues crystallising into disputes if properly implemented.

Keywords: BS11000, Collaboration, Disputes, Review

1. INTRODUCTION

Since the publication of the Latham Report (1994) and the Egan Report (1996) collaborative working relationships have been in and out of vogue in the construction industry. In the period 2000 to 2005 there was a marked increase in the implementation of information and communication technologies (ICT). The introduction of ICT enabled collaborative working to form part of the construction industry's everyday practices. Collaboration was established as being key to improving the industry in the Latham Report. However, throughout the recent recession, the industry resorted to "jungle warfare" with suicidal tendering practices. Very quickly after the start of the recession in 2007, many organisations reverted back to their previous practices, setting aside all that they had learnt after from the Latham Report (Gardiner, 2014). The construction industry has a history steeped in disputes which often arise as a result of the parties interpreting matters contained in the contracts differently. Collaboration under BS11000 provides an opportunity for clients, designers, contractors and other parties to construction projects to come together from a very early stage and form relationships in advance of any actual physical work being carried out on site. Where disputes do arise, it is all too often the case that the relationships have become so broken down that the only hope of concluding a dispute is to enter into dispute resolution methods such as mediation, adjudication, arbitration or litigation. Each can be costly and it can take time to resolve the dispute and, although adjudication in particular is promoted as being a speedy method of dispute resolution, it has to be more beneficial for organisations to work together to try and prevent differences becoming a crystallised dispute. In order to establish the potential benefit of a collaborative working relationship it is critical to consider common construction disputes and how BS11000 could be adopted to reduce the number of differences reaching a dispute which two parties cannot resolve between them.

Consideration also needs to be given as to whether it is sufficient for parties to agree to work collaboratively or if it is essential that the contract underpins the basic principles of BS11000. The paper is divided into three sections: The first part provides a brief insight into collaborative business relationships; encompassing the basis, aims and objectives of BS11000. The second section focuses on whether it is the nature of the construction industry that leads to the industry being highly litigious or whether it is the mannerisms and attitudes of the key players in the industry that fuel the disputes. The final section draws together the most common disputes and the basic principles of BS11000 to consider whether the benefits of working collaboratively introduce the possibility of utilising BS11000 to help prevent differences becoming crystallised disputes.

2. COLLABORATIVE WORKING RELATIONSHIPS AND BS11000

There have been a great number of studies carried out over the years in relation to collaborative working. However, it is clear from the research that has been carried out that there is no one single agreed definition of collaboration. Some writers use the terms “partnering” and “alliance” as being synonymous with collaboration, often using the terms interchangeably. The collaborative process seeks to bring together parties to a construction project together at the earliest possible point in the process with a view to building an open and honest relationship as the works progress. BS11000 is the first standard to be produced for collaborative working and introduces itself as having the aim of providing a strategic framework to establish and improve collaborative relationships in organisations of all sizes, addressing the requirements for collaborative relationship to ensure they are effective, optimised and deliver enhanced benefit to the stakeholders.

2.1. Principles of BS11000

In essence, BS11000 creates an alternative business model that promotes the sharing of knowledge, skills and resources in order to meet mutually-defined objectives and helps bring new levels of value creation whilst aiming to help create an environment of trust that supports the delivery of joint improvements. BS11000 recognises that the spectrum of organisations that may choose to implement it is vast and it has not been written with the intention of establishing a “one-size fits all” solution to the building of collaborative relationships but instead it is intended to be a consistent framework that can be applied to organisations and collaborative relationships of all sizes. The standard is based on an eight stage framework. The eight stages are grouped into 3 phases: strategic, engagement and management.

Awareness

The first stage of the framework is awareness. During this stage organisations must review their overall strategic corporate policy and processes. By raising awareness of these policies and processes the organisation can establish how collaborative relationships will be able to add value to their business. In order to successfully implement collaborative business relationships, the BS11000 framework highlights the requirement to appoint a Senior Executive Responsible (SER) to have responsibility for the development and implementation of the organisation’s collaborative business relationships and the processes involved with this. Under the framework, the SER is responsible for the organisation’s collaborative business relationship policy and defining the scope of the organisation’s collaborative working management system.

Knowledge

Once the initiating organisation has created awareness of the benefits of collaborative relationships and how this can be implemented to add value to the organisation, the next stage of the framework is identified as the knowledge stage, during which the initiating organisation is required to develop their strategy and business approach for the collaborative opportunities that have been identified. The framework outlines the need for the development of a specific business strategy which can be used to evaluate and document each new collaborative opportunity, determining specific objectives and key drivers. During the knowledge phase, organisations should address competencies of their individuals and the roles that they perform, identifying their skills and training requirements. The final stage within the strategic phase is the Internal Assessment stage. This stage requires the organisation to assess their readiness to implement collaborative business relationships and gain an understanding of their internal capabilities in order that they can define their expectations of external parties. Once the first three stages have been undertaken the framework progresses to the engagement phase and stage 4 focuses on the partner selection stage. During stage 4 the initiating organisation sets out the process that they will undertake in order to identify and select their collaborative partners. Initiating organisations nominate their potential collaborative partners then evaluate each one using their defined process and their predetermined selection criteria. Once due process has been followed, collaborative partners can then be chosen and the Relationship Management Plan updated to reflect this. Once the collaborative partners have been identified the fifth stage of the process begins. During this stage the focus moves from purely the initiating organisation to a more joint approach between the initiating organisation and the collaborative partners putting onus on each of the parties to accept the collaborative responsibility for managing an integrated process. The final phase of the engagement stage is in relation to value creation, focusing the initiating organisation and their collaborative partners to ensure that the works or services have enhanced value through the implementation of the collaborative business relationship.

Management

The final two phases in the standard are grouped in to the management stage. This stage looks at how the parties work together to ensure that the relationship stays together and how the parties leave the relationship once the deliverables have been met. Staying together is considered in phase 7 while the exit strategy is governed by phase 8. Phase 7 looks at the ongoing management, monitoring and measurement of the collaborative relationship encouraging parties to be aware of the collaborative processes that are to be maintained while the works or services progress whilst looking for innovative ways to achieve the deliverables and create value within the relationship.

3. CONSTRUCTION DISPUTES – NATURE OR NURTURE?

It has been said that the adversarial nature of the construction industry has created a hostile and litigious environment (Bishop et al, 2010) where disputes are common place. There are numerous studies that support this assertion however; there is also a growing number of studies that promote more positive business relationships, highlighting an acceptance that there is a need for change within the industry. Over the last few years, Arcadis have undertaken an annual study of the types of disputes arising out of construction contracts to establish an understanding of the construction industry both geographically and globally. In their Global Construction Disputes Report 2015 (Arcadis, 2015) they conclude that, in 2014, the 5 most common causes of construction disputes in the UK were:

1. A failure to properly administer the contract
2. Employer, contractor or subcontractor failing to understand and/or comply with its contractual obligations
3. Poorly drafted or incomplete and unsubstantiated claims
4. Conflicting party interests (subcontractor / main contractor / employer or Joint Venture partner)
5. Incomplete design information or Employer Requirements (for Design and Build)

In order to establish if the implementation of collaborative business relationships can have a positive impact in preventing construction disputes, it is beneficial to have an understanding of why construction disputes arise, whether the nature of the industry means that disputes are always going to be there requiring input from third parties to resolve or whether differences of opinion crystallise into a dispute because that's historically the mind-set that develops in those working in the industry, passed down through the generations.

3.1 The nature argument

Akintan and Morledge (2013) brought together research to conclude that traditional procurement is the dominant procurement form in the UK construction industry and has been since the industrial revolution in the nineteenth century. The RICS draft guidance note advises that the traditional approach is perhaps still popular with those in the construction industry because it is something that they are familiar with as opposed to because it is fit for purpose, listing some advantages and disadvantages of its use (RICS, 2015). There is no shortage of case law covering all manner of disputes in relation to construction projects. That, coupled with the numerous research papers that refer to the construction industry as “fragmented”, give the impression that it is the nature of the industry that leads many contracts down the dispute route. In a study by Kale and Arditi (2001) it is suggested that it is the quality of the relationship between the contractor and the subcontractor that affects the contractor's ability to perform on projects. Akintan and Morledge (2013) also suggest that the current construction industry is so specialised that there is no one organisation that can provide all of the specialisms required therefore there is a dependence by the main contractor on the smaller, specialist subcontractors to deliver their contracted works. By taking these two facts together it can be concluded that it is essential for these two parties to form a strong working relationship for the project to be measured as a success. A similar view is taken by Batt and Purchase (2004). They suggest that performance is dependent on activities and performance of others and therefore the quality of the relationship impacts on this. Black *et al* (1999) report that there are 4 main perceived failings of traditional adversarial relationships: exploitation is common; specifications are rigid decisions are made with limited knowledge and; there is a focus on the short term. Part of the logic behind collaborative relationships is that there is a focus on building lasting relationships that are driven by the promise of a future workload. However, Cox and Thompson (1997) draw comparison to the collaborative models in the manufacturing industry and note their limited use in construction based on their opinion that, in the construction industry, repetition is rare and works are typically procured on a one-off basis. They also consider the fact that traditionally, relationships in the construction industry have been conducted from afar, where contracts are often awarded through competitive tender, procuring the lowest priced supplier, leading to adversarial relations and opportunistic behaviour. The construction industry is primarily driven by time and cost. All projects have a timeframe in which they are to be built and a budget that is determined often long before the project commences. Quite often it is the case that this focus on time and cost that can lead to disputes arising.

3.2 The nurture argument

The other argument is that it is not the nature of the industry that leads to disputes but more so the attitudes and expectations of those involved in the industry that lead to such a high number of disputes arising in the industry. It is possible that, as it is evident that there is a long history of disputes in the construction industry, the crystallising and defending of the dispute is passed down through the generations that often success is measured on one's ability to "win" in a claim situation. Barlow *et al* (1997) conclude that that partnering is not purely the implementation of a set of practices or techniques but its success is reliant on attitudes being changed along with behaviours. One of the key factors in preventing construction disputes is trust. Briscoe *et al* (2001) highlight that, in order for there to be significant improvements in the construction supply chain operation, there is a need for investment in new skills with an emphasis being placed on open relationships to reduce the distrust that is common within the industry. Interviews were undertaken during this study and the analysis of these interviews revealed that there were significant attitudinal barriers between the subcontractors and the main contractors. These barriers included a perception that main contractors took advantage of the weaker subcontractors and that these were unlikely to improve as "*the leopard could not change its spots*". Humphries *et al* (2003) draw on other research to conclude that, in the context of construction, working behaviour is often negatively affected by the fact that main contractors realised that by driving down the price of their subcontractors they are increasing their potential cost savings therefore it is common place for unfair practices to prevail with most relationships still being dominated by the perceived power of the participants. With this in mind, the atmosphere of suspicion that is founded on previous behaviour, has resulted in many companies being reluctant to work to build closer relationships with their adversaries (Moore *et al*, 1992). Another essential factor which can impact on the presence of disputes in the construction industry is co-operation. It is all very well when a company is vociferous in its support of working with the other players in a project and this process has support from senior management however, if there is a lack of willingness to co-operate at interpersonal or operational levels within the organisation then the entire process can be undermined (Bresnan and Marshall, 2002). Communication is also a key contributor to the crystallising of disputes. It is commonly understood that contractors are used to being secretive with their information (Wood *et al*, 2005).

3.3 The case law story

Where consultants are employed there is scope for disputes to arise. An example of this is in the case of *Costain v Charles Haswell* (*Costain v Charles Haswell & Partners* [2009] EWHC B25 (TCC)) whereby a claim was brought against Haswell in relation to damages for breach of contract and/or negligence, with Costain alleging that Haswell had produced a design that was defective and that they had incurred significant additional cost and delay to the works as a result. Although Costain came out of the case victorious, they were subject to criticism over an over-inflated claim and their conduct during the proceedings and both parties being criticised over their attitude to settling the dispute, both parties appear to have put self-interest before making a reasonable attempt to settle the dispute without litigation. Agreement of final account sums can result in dispute particularly where there are cost and time over-runs. These disputes often arise over the valuation and agreement of entitlement to variations. In the case of *St Austell v Dawnus* (*St. Austell Printing Co. Ltd v Dawnus Construction Holdings Ltd* [2015] EWHC 96 (TCC)) there were 115 variations disputed within the final account submission and the final account discussions were protracted and did not progress smoothly.

Matters were not helped by a change of contract administrator whose replacement was not openly accepted by the contractor. Issues also arise in agreeing entitlement to an Extension of Time when the works are completed after the agreed contract completion date. In construction, late delivery brings costs and it is often who bears the burden of these costs that lead to dispute, particularly where there are liquidated damages that can be applied. One of the major recent cases relating to this is *City Inn v Shepherd Construction* (*City Inn Ltd v Shepherd Construction Ltd* [2010] ScotCS CSIH_68) and the matter is also raised in the case of *Balfour Beatty v Shepherd Construction* (*Balfour Beatty Engineering Services (HY) Ltd v Shepherd Construction Ltd* [2009] EWHC 2218 TCC, 127 Con LR 110). Another factor that has the potential to impact on disputes is the complexity of the contractual arrangements. This is particularly so when contractors are passing on risk to the supply chain. There can be references made to main contract documents and provisions which can lead to disputes arising over the proper construction of the subcontract (*Bovis Lend Lease Ltd v Cofely Engineering Services* [2009] EWHC 1120). The complexity of the arrangement causing dispute is also highlighted in the case of *Hyder v Carillion* (*Hyder Consulting (UK) Ltd v Carillion Construction Ltd* [2011] EWHC 1810 (TCC)) where there was a mechanism in the contract for work being undertaken on a lump sum basis and time related charges for work not covered by the lump sum price. The main contract was based on a target cost and disputes arose over the build-up to the fee claimed by Hyder in relation to the target cost. Framework contracts are also not without their problems. In the case of *Amec v Thames Water* (*AMEC Group Ltd v Thames Water Utilities Ltd* [2010] EWHC 419 (TCC)) there was an encompassing framework agreement in place between the parties and a dispute arose over payment which resulted in a further dispute as to whether it was the terms of the works order or the framework agreement that were relevant to the payment issues.

4. COLLABORATIVE BUSINESS RELATIONSHIPS AND CONSTRUCTION DISPUTES

It has been widely discussed that the construction industry needs to move away from the fragmented process that is it historically renowned for, the fragmentation of the industry that is seen as the critical factor that results in its poor performance (Xue *et al*, 2010), and find a solution for reducing the amount of time and money that is expended through the crystallisation of disputes during the lifecycle of projects. Until the publication of BS11000, although there was much research carried out into collaborative working encompassing its various iterations, there was a gap in the knowledge base that may have prevented a more widespread acceptance of collaboration as a process in that the term collaboration was, in literary terms, used as an umbrella term (Hughes *et al*, 2012) and the actual collaborative process was not particularly well defined. Now that there is a British Standard in place to guide organisations through a defined process for implementing a collaborative business relationship, can collaboration be used as a tool to reduce construction disputes?

4.1 Common disputes and the collaborative solution

In an ideal world, collaboration would provide the mechanism to eradicate dispute altogether. However, in reality this is unlikely to ever be achieved. In a study undertaken by Ross (2009), it is concluded that conflicts will occur during a project and that a process that sets out conflict prevention and resolution is essential within the partnering process. By forming the Relationship Management Plan (RMP) as described in BS11000, organisations can agree at the

commencement of their relationship how these matters will be dealt with. BS11000 recommends that the RMP include a section that details the intervention process that includes issue resolution. This is further emphasised in Clause 9.7 which states that a defined procedure for issue resolution is to be implemented by the joint management team and that issues should be identified, addressed, and resolved at the earliest opportunity and at the optimum level with an escalation procedure that should only be invoked when it becomes absolutely necessary. In order for this to be successful, the senior management teams for the collaborative partners must give the necessary authority at the optimum level.

Dispute catalysis

In order to work to prevent disputes, or at least work to agree differences before they escalate into a full blown dispute, it is logical to first consider what circumstances are most likely to cause disputes. As stated by Hawkins (2013) there are 4 frequent basis of disputes: Market Changes; Processes; Communication and; the Breakdown of Trust.

Market changes

Hawkins defines market changes as a change to the demands of the market that the collaborative partners are working in. He suggests that changes in demand in the market may result in organisations reconsidering how they operate and redefining what is important to them. Following the recession that was prevalent through the late 2000's and into the early 2010's it was reported by Hughes *et al* (2012) that, due to the economic crisis, partnering saw diminishing support. This could have been the result of clients resorting to the traditional relationships that they were familiar and comfortable with, or it could have been the result of organisations either not having the resources to invest in the development of the process or that they were unwilling to invest the resources during the period of economic uncertainty. One of the major benefits of a collaborative relationship is that the relationships are built up over time and are strengthened by the promise of future work between the collaborative partners. Many projects in the construction industry are single in nature and it has been reported that partnering relationships can only form over the long term and therefore are unsuitable for single projects (Cox & Thomson, 1997). That is not to say that collaborative relationships cannot work on single projects. BS11000 advocates that effective collaboration will, over time, be able to create an environment that engenders trust between organisations. The inclusion of a joint exit strategy at the outset of the relationship which clearly defines how the relationship will be disengaged has the benefit of assisting in creating a culture of openness and honesty which recognises changing market dynamics over time. Clause 10 of BS11000 encourages the collaborative partners to consider future opportunities and be aware that the relationships that they build may be created, dissolved and rebuilt over time to their mutual benefit.

Processes

Every individual organisation will have its own policies and procedures which determine the ways in which tasks and processes are undertaken. Conflicts often arise in construction due to the different attitudes created as a result of the differing policies and procedures contracting organisations have. As has previously been discussed, stage 5 of BS11000 is where the collaborative partners establish the right environment to support their collaborative working environment. However, the need to implement a joint strategy for the relationships is not without its own set of problems. Conflicts can arise within a collaborative partnerships when individuals have a desire to continue working with the systems and processes with which they are familiar. Conflict can also arise when organisations have to implement processes that do not align with their internal procedures and they are put under pressure by their internal management to follow their own procedures as opposed to those of the collaborative

partnerships. In order for collaboration to provide a positive solution to the problem of conflicting processes, it is essential for the collaborative process to be supported by senior management. Support of senior management has been identified as being vital in making a collaborative approach both credible and legitimate (Bresnen & Marshall, 2000). In the study carried out by Bresnen and Marshall, it was concluded that in instances where collaborations received strong senior management support, it was often the case that there were considerable difficulties reported in the cascading of the concept down through the organisation and it then being translated into practice. This theory was supported by the research undertaken by Alderman and Ivory (2007). In order that collaborative working can facilitate a reduction in the number of disputes that arise over processes, it is required that parties agree a common vision and priorities for the collaboration (Shelbourn et al, 2007).

Communication

Communication is a key player in the success of any working relationship. However, if information is not passed on to the people or processes that need it or if it is shared in a restricted form, problems can occur (Hawkins 2013). There is a plethora of data which identifies that one of the key factors in disputes arising is a lack, or breakdown in, communication. A study carried out by Rahman, *et al* (2013) established that communication is one of the important facets of collaboration, as identified by the sample that they surveyed. Lambert and Cooper (2000) highlights that information sharing in the relationship between main contractors and sub-contractors will improve the performance of the project. It has been identified that, by effectively communicating throughout the supply chain, there can be a sharing of ideas and visions that can result in fewer misunderstandings (Cheng and Love, 2000). Furthermore, communication can be further enhanced by the implementation of 2-way communication as this can minimise misinterpretation (Chen and Chen, 2007). Not only is the sharing of information and the communication between the parties important but the timing of the communication is also important to the success of the collaboration. This requires direct lines of communication among all team members (Larson, 1995). Successful communication also relies on problems being highlighted as soon as they become apparent and solved by the relevant people at the lowest possible level. If only routine matters are communicated to all concerned and important issues are simply banded about between head office and site without proper interaction, partnering will fail (Moore *et al*, 2002).

Breakdown of trust

Another key factor that causes disputes in construction is trust. This can be either when one or both of the parties to the agreement fail to establish trust or where a trust that was once there is gone. It is often true that, once the trust in the relationship is gone, there is little that can be done to restore that faith between the parties and that, as a result of this, relationships become so fragmented that there is no going back. Trust is a multi-faceted, complex concept. Trust is opined as being dynamic in that it is either growing or diminishing (Hawke, 1994) and is set out by Hartman (2003) as having three bases within a construction context: competence trust; integrity trust and; intuitive trust. Historically, there is a lack of trust between parties in the construction industry. As a result of this fact it is little wonder that the implementation of collaborative working, where the emphasis is on trust and knowledge sharing, this new found desire to be open and honest is viewed by contractors with an air of scepticism. Trust is one of the main themes of BS11000 and the whole ethos of collaborative working is to be able to grow a long term relationship that is built on a mutual trust. BS11000 encourages its users to openly share information and work together to create a win-win solution to the problems that are encountered. It is important that the trust is cascaded down through all levels of the supply chain in order that the success of collaboration in preventing disputes can be maximised. The

success of collaborative relationships is based on trust from client level down through contractors to specialist contractor and subcontractor level.

4.2. Top 5 construction dispute areas and collaboration

Above, this research looked at the top 5 categories of construction disputes in 2014. It was noted that there has been little significant change in these categories over recent years and, generally, the UK construction industry's categories are comparable with the global construction market. It is accepted that there will always be differences of opinion throughout the life cycle of construction projects. How then do the principles of collaboration as defined by BS11000 seek to encourage a reduction in crystallised construction disputes?

Contract administration

The ethos of collaboration is not built on contractual provisions therefore BS11000 does not prescribe how to manage contractual relationships. Indeed, BS11000 leaves the decision on the requirement for a formal contractual agreement being implemented to be at the discretion of the collaborative partners. That said, by implementing the collaborative ethos within construction projects and openly and honestly sharing information and escalating issues as soon as they become apparent, there is scope for minimising dispute in this area. By making others aware of the issues, it is possible to resolve the matter constructively at the correct time and, by effectively communicating the issues, there is a clear communication trail and there are no nasty surprises for the other party. By adopting these principles, the administration of the contract should not be brought into question therefore reducing the number of disputes of this type.

Failure to understand contractual obligations

Part of the thinking towards collaborative relationships is that the consultants, contractors, subcontractors and specialist contractors are brought in to the discussion process much earlier than they would be under traditional construction contract. By implementing this process parties will become more aware of what is expected of them within the delivery process. By creating joint objectives and a joint relationship management plan, parties become familiar with their obligations much earlier than they would have traditionally. Part of the collaboration process under BS11000 focuses the attention of the organisations on the skills, competencies and abilities of their people. By establishing their requirements at an early stage in the partnering process, it is possible for the organisations to put the right people in the right positions within the relationship. Having the right people in the right positions allows the right questions to be asked at the right point in the process, resulting in more awareness of what is required of each party to the agreement. By working together to form joint goals and objectives, the collaborating organisations are building common understanding of their requirements which should potentially reduce the scope for uncertainty in contractual obligations.

Claims

Poorly drafted claims or claims that are unsubstantiated are frustrating for all parties. Often organisations will know that they have an entitlement for matters connected to their contract but often will not have the historical data in place to substantiate what they desire to obtain. In essence, the collaborative relationship framework seeks to minimise the number of differences culminating in a formal dispute. By encouraging good relationship management between the parties to the agreement and implementing a process for dispute resolution as early as possible in the process and at as low a level as is practical, collaboration seeks to have

differences resolved at the most practical level, minimising the impact and the costs associated with the process. Often, organisations identify the need to submit a claim much further down the line than is required of them under the contract conditions. The gathering of information and compilation of the facts is time-consuming and often costly. In order to maximise their return, organisations often introduce claim specific resources who have not been directly involved in the project as events occur and often have to search for the facts to make the argument that they want to present stack up. By implementing a collaborative relationship, endeavouring to resolve issues when they arise should address these matters long before the parties reach stalemate.

Conflicting party interests

Often, in a traditional contracting arrangement, there is suspicion and mistrust between organisations. Despite the parties ultimately working to reach a common goal, the mistrust between the organisations often results in them pulling in opposite directions, forcing them to work against each other. Implementing the principles of BS11000, organisations agree on a set of joint objectives and a clear set of objectives and goals it is hoped that any conflicting party interests can be removed. By continually managing the relationship, assessing its development and generally being aware of how the relationship is progressing, organisations have the opportunity to be aware if conflicting interests are developing and work to engineer a solution before the conflict takes over and the possibility of resolution dwindles. By building a working relationship between organisations and their people, the trust dynamic can be improved and parties will become less suspicious of the other parties intentions.

Incomplete design information

Arguably, one of the areas where collaboration could provide benefit in preventing construction disputes is in relation to incomplete design information. As has been previously discussed, collaborative relationships promote early contractor involvement. This involved bringing contractors and specialist contractors into the process at an early stage, often when the design development stage is in its infancy. By engendering this culture, organisations are able to knowledge share and this can result in specialists being able to introduce design solutions before the process is too far developed, encouraging innovation and value engineering. Also, by bringing the parties together early, the risks can be allocated to the partner best placed to deal with that risk. Instead of trying to pass all risk down the supply chain, the risk can then sit with the party who can manage that risk most effectively.

5. CONCLUSION

Collaborative working can have a positive impact on preventing disputes from crystallising in the construction industry. However, it is important that a clearly defined process is established and followed. By implementing a collaborative framework such as BS11000, there is the potential for improving relations and preventing issues that would traditionally crystallise into a dispute reaching this stage. It has been identified through studies that collaborative projects still encounter problems along the way, and not all are insignificant. However, the test of the procedure was the way in which the problems were addressed. In research undertaken by Bresnen and Marshall (2000) there was evidence that these significant problems were resolved without recourse to claims and litigation which is intimated that would have been the case under a traditional arrangement. There was however evidence in their study that contractors absorbed additional costs simply to maintain the relationship. When the parties to a collaborative working arrangement do not have a thorough understanding of the type of

relationship that they are expected to develop with those that they are working with, collaboration can be used as a method of trying to coerce one party into submitting to the demands of another, commercially bullying that party into giving up. By using collaboration in this way, it is likely that a high proportion of contracts adopting a collaborative working process will culminate in a dispute of some sort. However, if the parties fully embrace the collaborative working relationships and work in the true spirit of collaboration, with the intention of forming lasting relationships that are not simply in place for a single contract but are long term with the intention of working together in the future then collaborative working can have a positive effect of the number of construction disputes requiring third party involvement to resolve. In order for collaborative relationships to be successful, the Relationship Management Plan (RMP) plays a significant role in the process. By creating and maintaining the RMP, it becomes a dynamic document that is fit for purpose and is useful as a tool to assist with preventing the issues becoming disputes.

6. REFERENCES

Cases

- AMEC Group Ltd v Thames Water Utilities Ltd [2010] EWHC 419 (TCC)
 Bovis Lend Lease Ltd v Cofely Engineering Services [2009] EWHC 1120
 City Inn Ltd v Shepherd Construction Ltd [2010] ScotCS CSIH_68
 Costain v Charles Haswell & Partners [2009] EWHC B25 (TCC)
 Hyder Consulting (UK) Ltd v Carillion Construction Ltd [2011] EWHC 1810 (TCC)
 St. Austell Printing Co. Ltd v Dawnus Construction Holdings Ltd [2015] EWHC 96 (TCC)
- Alderman, N. and Ivory, C., (2007), Partnering in major contracts: Paradox and metaphor, *International Journal of Project Management* 25 (2007) 386-393
 Akintan, O.A. and Morledge, (2013), Improving the Collaboration between Main Contractors and Subcontractors within Traditional Construction Procurement, *Journal of Construction Engineering*, Volume 2013, article ID 261236
 Arcadis (2015) *Global Construction Disputes Report 2015 The Higher the Risks, The Bigger the Risk*, Arcadis.
 Batt, P.J. and Purchase, S (2004), Managing collaboration within networks and relationships, *Industrial Marketing Management* 33 (2004) 169-174
 Balfour Beatty Engineering Services (HY) Ltd v Shepherd Construction Ltd [2009] EWHC 2218 TCC, 127 Con LR 110
 Barlow, J., Cohen, M., Jashapara, A. and Simpson, Y, (1997) *Towards Positive Partnering*, The Policy Press, Bristol
 Black, C., Akintoye, A. and Fitzgerald, E (1999) An analysis of success factors and benefits of partnering in construction, *International Journal of Project Management* 18 (2000) 423-434
 Bresnen, M & Marshall, N (2000) Partnering in construction: a critical review of issues, problems and dilemmas, *Construction Management and Economics*, 18:2, 229-237, DOI: 10.1080/014461900370852.
 Bresnen, M. and Marshall, N., (2010), Building Partnerships: case studies of client-contractor collaboration in the UK construction industry, *Construction Management and Economics*, 18:7, 819-832.
 Briscoe, G., Dainty, A.R.J. and Millett, S, (2001), Construction supply chain partnerships: skills, knowledge and attitudinal requirements, *European Journal of Purchasing & Supply Management* 7 (2001) 243-255
 British Standards Institute (2010) *BS11000 Collaborative Business Relationship – Product Guide*, BSI Group
 Cox, A. and Thompson, I. (1997) ‘Fit for purpose’ contractual relations: determining a theoretical framework for construction projects, *European Journal of Purchasing and Supply Management*, Vol 3, No. 3 pp 127-135
 Egan, J (1998) *The Egan Report – rethinking construction; report of the construction industry task force to the deputy prime minister*, London, HMSO.
 Gardiner, J. (2014), *Latham’s Report: Did it change us?* *Building*, <http://www.building.co.uk/lathams-report-did-it-change-us/?/5069333.article> visited 25 May 2015
 Hawke, M. (1994), Mythology and reality – The perpetuation of mistrust in the building industry, *Construction Papers of the Chartered Institute of Building* Vol. 41, 1994 pp 3-6
 Hawkins, D.E. (2013) *Disputes: Conflict or Catalyst (Assessing the true impact of disputes in a business environment and the potential to harness constructive conflict in collaborative business models*. October.

- Humphries, P., Matthews, J. and Kumaraswamy, M. (2003) Pre-construction project partnering: from adversarial to collaborative relationships, *Supply Chain Management: An International Journal*, Vol. 8 Iss 2 pp 166-178
- Kale, S and Arditi, D (2001) General contractors' relationships with subcontractors: a strategic asset, *Construction Management and Economics*, Vol 19, No. 5 pp 541-549
- Lambert, D.M. and Cooper, M.C (2000), Issues in supply chain management. *Industrial Marketing Management*, Vol 11. No. 1 pp 65-83
- Latham, M. (1994) *Constructing the Team*, London: HMSO
- Moore, C., Mosley, D. and Slagle, M. (1992) Partnering: guidelines for win-win project management, *Project Management Journal*, Vol. 23 No. 1, pp 18-21
- Rahman, S.H.A, Endut, I.R., Faisal, N. and Paydar, S. (2013) The Importance of Collaboration in Construction Industry from Contractors' Perspective, *International Conference on Innovation, Management and Technology Research*, Malaysia, 22-23 September 2013, *Procedia – Social and Behavioural Sciences* 129 (2014) 414-421
- RICS Draft Guidance Note – Comparative construction and engineering contracts, <https://consultations.rics.org/consult/ti/comparative.construction/view?objectId=2425044> visited 12 September 2015
- Shelbourn, M. Bouchlaghem, C. and Carrillo, A.P. (2007), Planning and implementation of effective collaboration in construction projects, *Construction Innovation*, Vol 7 Iss 4 p 357-377
- Taylor (2012) BS11000 (the new standard for collaborative business relationships) – What is your motive? Posted November 13, 2012 by Bill Taylor www.thinksignam.co.uk/BS11000-the-new-standard-for-collaborative-business-relationships-what-is-your-motive/ Visited 01 September 2015
- Wood, G.D. and Ellis, R.C.T., (2005), Main contractor experiences of partnering relationships on UK construction projects, *Construction Management and Economics* 23 (3), pp 317-325
- Wu, S. Greenwood, D. and Steel, G. (2008) Exploring the Attributes of Collaborative Working in Construction Industry. *Northumbria Built Environment Working Paper Series*, Vol. 1 No. 2, 2008
- Xiaolong Xue, Qiping Shen and Zhaomin Ren, Critical Review of Collaborative Working in Construction Projects: Business Environment and Human Behaviours (2010), *Journal of Management in Engineering* 2010.26:196-208

THE ENVIRONMENTAL LAW CHALLENGES TO THE REGENERATION OF BROWNFIELD LAND

J. Charlson and J. Donovan

School of Architecture and the Built Environment, University of Wolverhampton, UK

Email: j.charlson@wlv.ac.uk

Abstract: This paper addresses the environmental law challenges to the regeneration of brownfield land. There is a focus on housing in the West Midlands but the issues are applicable to other developments across the country. The contaminated land legal regime and environmental law issues including waste, water and environmental impact assessments are analysed. The political agenda is then examined. Finally, conclusions are reached for practice and academia. Developers may be discouraged from developing brownfield land due to the risk of being served a remediation notice and committing a water pollution offence. Construction operations may require a waste treatment permit and an expensive environmental impact assessment. The majority of environmental law applying in England originates from Europe so the opportunity to revise this area of law has arisen. The contaminated land regime could be changed to remove liability from subsequent owners or occupiers of the land. However, the benefits of the remediation of brownfield sites for housing seem to be a political priority but reform of challenging environmental law issues less so. Understandably, the legal complexities of Brexit will take higher precedence.

Keywords: Brownfield Land, Contaminated Land, Environmental Law, Political Agenda, Water Pollution

1. INTRODUCTION

This paper examines the environmental law challenges to the regeneration of brownfield land. The introduction sets the issues within the political context. There is a focus on housing in the West Midlands but the issues are applicable to other developments across the country.

The second section analyses contaminated land challenges including the legal regime, case law, critique of the legal system, the Environmental Liability Directive and funding. The third section examines environmental law issues including waste, water, environmental impact assessments and environmental liabilities on insolvency.

The fourth section explores the political agenda including West Midlands priorities, Brexit implications, better regulation and the priority of environmental law reform. Finally, conclusions are reached for practice and academia.

1.1 Political context

Wong and Schulze-Baing (2010) explain that the reuse of brownfield land for housing has been a major policy objective in England since the late 1990s. They conclude that this re-use helps improve income and employment prospects for the most deprived areas in Britain.

In January 2015, the Department for Communities and Local Government (2015) published their consultation proposals for building more homes on brownfield land. The consultation (p.9) explained that 'Brownfield' (previously developed) land is defined in Annex 2 of the

National Planning Policy Framework as: *“Land which is or was occupied by a permanent structure, including the curtilage of the developed land (although it should not be assumed that the whole of the curtilage should be developed) and any associated fixed surface infrastructure.”*

The Campaign to Protect Rural England (2016) argues that their research shows that brownfield sites across England can provide at least 1.1 million new homes.

The Chancellor (2016), in his Autumn Statement (on 23 November 2016), announced £2.3 billion for a new Housing Infrastructure Fund. *“The fund will be used for projects such as roads and water connections that will support the construction of up to 100,000 new homes in the areas where they are needed most. On top of that, £1.4 billion will be used to provide 40,000 new affordable homes, including some for shared ownership and some for affordable rent. And another £1.7 billion will be used to speed up the construction of new homes on public sector land.”*

The Housing and Planning Minister (2017), Gavin Barwell, confirmed on 3 April 2017 that Councils will have new tools to speed up development of derelict and underused land for new homes. He explained that local authorities across the country will now have to produce and maintain up-to-date, publicly available registers of brownfield sites available for housing locally. He added that the £3 billion Home Builders Fund will be used to support the development of brownfield sites, with an additional £1.2 billion provided to unlock at least 30,000 Starter Homes on brownfield land.

There is therefore a national political focus on developing housing on brownfield land.

2. CONTAMINATED LAND

This section explains the contaminated land legal regime illustrated by case law. The system is then critiqued and the requirements of the environmental liability directive outlined. The funding implications are then explored.

2.1 Legal regime

The purpose of Part 2A of the Environmental Protection Act 1990 (EPA 1990) is to identify and remediate contaminated land which poses an unacceptable risk to human health or the environment which is not being remediated voluntarily. Contaminated land is defined by section 78A(2) as:

“any land which appears to the local authority in whose area it is situated to be in such a condition, by reason of substances in, on or under the land, that—

(a) significant harm is being caused or there is a significant possibility of such harm being caused; or

(b) pollution of controlled waters is being, or is likely to be, caused”

The person primarily liable for the remediation costs is the “polluter” (Class A person) with the owner or occupier (Class B person) secondarily liable. Also, statutory successors will take on the liabilities of their predecessor entities (Lowther, 2006).

As Lees (2016, p. 12) explains, “*The [secondary] liability is justified not by fault or causation, but by a direct relationship with the land. The guidance on the contaminated land provisions in the UK demonstrates that the primary objectives of the regime are not to ensure that the polluter who caused damage is made to pay for that damage, but rather that the damage is remediated.*”

Under the statutory guidance, local authorities were required to devise and then implement an inspection strategy but no deadline was imposed. Therefore, local authorities have made slow progress inspecting their areas resulting in a lack of data on the extent of contaminated land in England and Wales (Fogleman, 2014b). Nevertheless, Part 2A imposes a duty on a local authority to serve a remediation notice on an appropriate person if the authority decides that land is contaminated (Fogleman, 2014a). Failure to comply with a remediation notice is a criminal offence.

A developer who purchases brownfield land runs the risk of the local authority subsequently serving a remediation notice on them as a Class B person. Their potential liability is uncapped and failure to comply could result in a criminal conviction.

2.2 Case law

Developers have indeed been served remediation notices as illustrated by the following cases concerning Circular Facilities (London) Ltd and Crest Nicholson Residential Ltd.

Circular Facilities

Circular Facilities (London) Ltd (CFL) built a residential estate on a site which was discovered by Sevenoaks District Council to be causing significant risk of harm to the residents from significant levels of methane and carbon dioxide seeping from pits filled with now decomposing organic material. In 2002, Sevenoaks DC served a remediation notice on CFL as a class A appropriate person (Brown, 2016). In *Circular Facilities (London) Ltd v Sevenoakes District Council* [2005], CFL appealed against the remediation notice. The case was confidentially settled out of court and the notice was revoked.

St Leonard’s Court

St Leonard's Court is a residential estate near St Albans in Hertfordshire. The site was previously a chemical works which was purchased by a developer. Bromate and bromide was discovered by St Albans DC to have leached into the soil contaminating the water source. The Environment Agency served remediation notices on both the former chemical works operator and the developer.

In *R (Redland Minerals Ltd) v Secretary of State for Environment, Food and Rural Affairs* [2010], the judge concluded “*not only that a manufacturer of chemicals had caused chemical contaminants to enter soil and groundwater, but that a developer that subsequently removed buildings and hardstandings from the site during its re-development for housing, had caused the chemicals to enter the groundwater due to rain falling directly on the ground and accelerating the entry of contaminants to lower levels in the ground*” (Fogleman, 2014a, p.50).

The related case was *R (Crest Nicholson Residential Ltd) v Secretary of State for Environment, Food and Rural Affairs* [2010]. The judge found both parties liable and apportioned liability between them.

2.3 Critique of the legal system

Brown (2016) argues that *Circular Facilities (London) v Sevenoakes District Council* [2005] illustrates the inadequacy of the contaminated land regime. Firstly, developers may be discouraged from developing contaminated land due to the risk of introducing pathways and receptors during construction. Secondly, local authorities are concerned about the expense of possible appeals to remediation notices including legal fees and funding the remediation costs themselves.

Fogleman (2014a) argues that Part 2A of the EPA 1990 is unfit for purpose. She found that (p.43) “*the introduction of a contaminated land regime that delegates primary implementation and enforcement authority to local authorities, and that severely limits their discretion in doing so, has resulted in a regime that has proven to be unworkable in practice and that has failed to meet its objectives.*”

2.4 Environmental Liability Directive

The contaminated land legal regime does not derive from Europe. Nevertheless, the Environmental Liability Directive (ELD) aims to create a framework of environmental liability, based on the “polluter pays” principle, to prevent and remedy environmental damage. The ELD does not impose remediation liability on the owner or occupier of land who did not cause or permit the contamination. But, the ELD does allow Member States to maintain or adopt more draconian provisions (Lees, 2016).

Lees (2016, p.7) identifies five models of liability of remediating contaminated land:

1. *The polluter should pay and no one else should pay. If the polluter cannot be found, there will be no liability for remediation.*
2. *As a priority, the polluter should pay, but where the polluter is not found, it may be possible for residual liability to rest elsewhere on, for example, owners or occupiers of the land or the State.*
3. *As a priority, the right sort of polluter should pay, but if the polluter does not meet those criteria (eg. fault), then others may also be liable. Causation is not the only test for being a polluter.*
4. *Liability is based primarily on fault, not causation.*
5. *The polluter may be liable, but so equally may others be, regardless of fault.*

The United Kingdom together with Austria, Bulgaria, Estonia, Finland, France, Hungary, Romania, Slovakia, Spain and Sweden has adopted the model 2 approach. However, an opportunity has arisen to evaluate this choice and perhaps consider a different framework.

2.5 Funding

Brown (2016, p. 211) argues that “*Public sector incentives have been cut so significantly that the potential uptake of contaminated sites by private sector developers is likely to decrease.*” The introductory section identifies potential sources of public sector funds but access to them seems unlikely to be straightforward.

Fogleman (2014a) identifies a key issue that remediation costs can exceed the value of the land itself.

3. ENVIRONMENTAL LAW ISSUES

Waste, water and environmental impact assessment issues are explored in this section. The implications of environmental liability on insolvency are then identified.

3.1 Waste

The Environmental Permitting (England and Wales) Regulations (2010) derive from the Waste Framework Directive 2006/12/EC. In England and Wales, if you wish to carry out a waste treatment activity on a site, you will need to get a permit from the Environment Agency or Local Authority.

Operations on brownfield sites may be considered to be waste treatment and have been subject to judicial scrutiny. In *Kent CC v Queenborough Rolling Mill Co Ltd* [1990], where an area subject to subsidence was filled with a mixture of ballast, china, china clay and broken pottery this was found to be waste.

By contrast, in *Cheshire CC v Armstrong’s Transport (Wigan) Ltd* [1995], building site rubble returned crushed to the original site to assist in rebuilding works was found not to be waste.

Construction operations on brownfield sites may require a waste treatment permit.

3.2 Water

The Water Resources Act 1991 aims to prevent and minimise pollution of water. The Act is enforced by the Environment Agency. Under the Act, it is an offence to cause or knowingly permit any poisonous, noxious or polluting material, or any solid waste to enter any controlled water.

Silt and soil are included in the definition of polluting material. If soil is found to be polluting a water body or watercourse, the Environment Agency may prevent or clear up the pollution, and recover the damages from the landowner or responsible person (Department for Environment Food and Rural Affairs, 2017).

In addition, many of the remediation declarations made have been regarding water pollution (Fogleman, 2014b):

- Warrington Borough Council, in 2008, issued a remediation declaration for the pollution of shallow groundwater and a nearby brook (controlled waters).
- Congleton Borough Council, in 2011, decided that Malkins Bank Golf Course was contaminated land. However, the council simultaneously issued a remediation declaration stating that it would be disproportionate to remediate the site because groundwater pollution was having limited impact on the quality of nearby surface waters.
- Cornwall Council, in 2011, issued remediation declaration for a former gasworks site where pollutants were entering the Fal Estuary through the harbour wall.

Thames Water Utilities Limited was fined £1 million (in respect of two related offences) arising from pollution of a canal in Hertfordshire during 2012 and 2013. The Environment Agency brought the case against Thames Water in relation to repeated discharges of polluting matter from a sewage treatment works into the Grand Union Canal in Hertfordshire. Thames Water pleaded guilty to two offences under the Environmental Permitting (England and Wales) Regulations 2010.

The development of brownfield land risks such offences as pollutants may already be present in the ground which may be released into controlled water by construction operations.

3.3 Environmental Impact Assessment

Environmental Impact Assessments (EIAs) are mandated for some developments by the 2011 EIA Directive.

Department for Communities and Local Government (2014) guidance explains that “*The aim of EIA is to protect the environment by ensuring that a local planning authority when deciding whether to grant planning permission for a project, which is likely to have significant effects on the environment, does so in the full knowledge of the likely significant effects, and takes this into account in the decision making process.*”

Glasson, Therivel and Chadwick (2012) explain that EIA is a process that examines that the environmental consequences of development in advance. There are five main steps: screening; scoping; preparing an environmental statement; making a planning application and consultation and finally decision making.

In *R (Bateman) v South Cambridgeshire District Council* [2011], the Court of Appeal gave important guidance on the need for sufficiently clear reasons to be given for a local authority’s decision on a screening opinion that an environmental impact assessment is not required.

Changes to the 2011 EIA Directive are detailed in Directive 2014/52/EU which was required to be implemented by 16 May 2017 (Holmes, 2016). Arabadjieva (2016) considers that the 2014 Directive is a significant evolutionary (though perhaps not revolutionary) step in the development of the EIA regime which is now a more detailed, structured and sophisticated instrument.

Development of brownfield sites may require expensive environmental impact assessments.

3.4 Environmental liabilities on insolvency

Mamutse (2016) warns that there is no special status for environmental claims in insolvency. So, administrative proceedings can be used to sell the profitable parts of a business, together with liquidation proceedings avoiding environmental liabilities. In *Re Celtic Extraction Ltd* [2001] the Court of Appeal concluded that a liquidator could disclaim a waste management licence on the grounds that it was onerous property thus shifting the costs onto its unsecured creditors.

4. THE POLITICAL AGENDA

This section examines the political agenda including West Midlands priorities, Brexit implications, better regulation and the priority of environmental law reform.

4.1 West Midlands priorities

Housing and brownfield sites are a political priority in the West Midlands; as evidenced by the Reeves (2017) booklet produced in accordance with The Combined Authorities (Mayoral Elections) Order 2017. The following statements were made by the mayoral candidates:

- *“It’s a plan to make sure we get the right level of housing that’s needed, without concreting over green spaces.”* (Andy Street, Conservative)
- *“Housing – I will ... incentivise the use of brownfield sites & protect greenbelt.”* (Pete Durnell, UKIP)
- *“Double the number of affordable new homes – and end the Tory scandal of homelessness, backed by a £500 million fund to clean up derelict sites.”* (Sion Simon, Labour)

The Conservative candidate, Andy Street, was elected as the first mayor of the West Midlands combined authority on 4 May 2017. Details of his housing plan are eagerly awaited.

4.2 Brexit implications

The result of the United Kingdom European Union membership referendum held on 23 June 2016 was 51.9% of voters in favour of leaving the EU (Pocklington, 2016). As a consequence, the UK government initiated the official EU withdrawal process on 29 March 2017 by serving notice under Article 50 of the Treaty on European Union (2007).

The majority of environmental law applying in England originates from Europe (Kellett, 2016 and Pocklington, 2016). However, the contaminated land regime does not derive from Europe.

4.3 Better regulation

Kellett (2016), who is the Director of Legal Services for the Environment Agency for England, outlines governments’ progress towards better regulation. The Coalition Government’s 2014 Regulators’ Code perpetuated the requirement that regulators perform their duties in a

business-friendly way. Furthermore, Section 108 of the Deregulation Act 2015 mandates regulators to have regard to the desirability of promoting economic growth so undertaking only necessary and proportionate regulatory action. A systematic review of existing legislation is proposed but this demands resources to generate the benefit of less regulation.

The Coalition Government's red tape challenge review of environmental law resulted in proposals to "*abolish 67 regulations, recast and improve 151 rules and uphold a number of other environmental laws*" (Kellet, 2016, p. 203). The most significant impact (saving £8.7 million per year) was a new system of electronic waste transfer notes.

Fogleman (2014b) advocates transferring implementation and enforcement of Part 2A of the EPA 1990 to the Environment Agency and imposing modified joint and several liability as the default for all persons who caused or knowingly permitted contaminated land.

The Housing and Planning Act 2016 contains provisions to grant automatic planning permission in principle on brownfield sites identified on statutory registers but secondary legislation and statutory guidance is essential for implementation. The previous government's regulatory priorities in England were deregulation and simplification.

There many initiatives to improve regulation but their impact merits analysis.

4.4 Priority of environmental law reform

The future direction of environmental policy and law in an independent UK will be determined by new trading agreements, international treaty obligations and national governments and administrations (Holmes, 2016). In particular, the extent to which current EU environmental laws will continue to apply to the UK is subject to review. "*The sheer scale of environmental law within the UK and its reliance on EU law would make a law-by-law assessment of changes a significant and time-consuming task*" (Holmes, 2016, p. 39). Nevertheless, Brexit will allow UK jurisdictions the freedom to develop their own agendas.

Voluntary agreements could be developed but Deanesly et al. (2016) highlight that such an agreement on the increased use of secondary aggregates failed resulting in the introduction of the Aggregates Levy.

The benefits of the remediation of brownfield sites for housing seem to be a political priority but reform of challenging environmental law issues less so. Understandably, the legal complexities of Brexit will take higher precedence.

5. CONCLUSIONS

In this section, conclusions are reached for practice and academia.

5.1 Practice

There is a national political focus on developing housing on brownfield land. However, developers face many environmental law challenges when endeavouring to progress housing

on brownfield sites including contaminated land, funding, waste treatment permits, water pollution, environmental impact assessments and insolvency:

1. Developers may be discouraged from developing contaminated land due to the risk of introducing pathways and receptors during construction. Also, local authorities are concerned about the expense of possible appeals to remediation notices including legal fees and funding the remediation costs themselves.
2. A developer who purchases brownfield land runs the risk of the local authority subsequently serving a remediation notice on them. Their potential liability is uncapped and failure to comply could result in a criminal conviction. Case law demonstrates that developers have been served remediation notices.
3. Potential sources of public sector funds have been identified but access to them seems unlikely to be straightforward. A key issue that remediation costs can exceed the value of the land itself.
4. Construction operations on brownfield sites may require a waste treatment permit.
5. The development of brownfield land risks water pollution offences as contaminants may already be present in the ground which may be released into controlled water by construction operations.
6. Development of brownfield sites may require expensive environmental impact assessments.
7. There is no special status for environmental claims in insolvency. So, administrative proceedings can be used to sell the profitable parts of a business, together with liquidation proceedings avoiding environmental liabilities.

5.2 Academia

There are many topics which merit future research including:

1. Details of the new West Midlands Mayor's housing plan.
2. The majority of environmental law applying in England originates from Europe so the opportunity to revise this area of law has arisen.
3. Previous researchers have argued that Part 2A of the EPA 1990 is unfit for purpose. In the United Kingdom, as a priority, the polluter should pay, but where the polluter is not found, it may be possible for residual liability to rest elsewhere on, for example, owners or occupiers of the land or the State. However, an opportunity has arisen to evaluate this choice and perhaps consider a different framework.
4. There many initiatives to improve regulation but their impact merits analysis.

The benefits of the remediation of brownfield sites for housing seem to be a political priority but reform of challenging environmental law issues less so. Understandably, the legal complexities of Brexit will take higher precedence.

6. REFERENCES

- Arabadjieva, K. (2016) Better Regulation In Environmental Impact Assessment: The Amended EIA Directive. *Journal of Environmental Law*, **8** (1), pp.159-168
- Brown, L. (2016) The contaminated land regime and austerity. *International Journal of Law in the Built Environment*, **28** (3), pp.210-225
- Campaign to Protect Rural England (2016) *More than a million homes possible on suitable brownfield land* [Online]. [Accessed 22 May 2017]. Available at: < <http://www.cpre.org.uk/media-centre/latest-news-releases/item/4414-more-than-a-million-homes-possible-on-suitable-brownfield-land?highlight=WyJicm93bmZpZWxkiwiJ2Jyb3duZmlbGQlLCJzaXRlcylsInNpdGVzJyIsInNpdGVzJywiLCJicm93bmZpZWxkiIHNdGVzI10=>>
- Chancellor (2016) *Autumn Statement 2016: Some of the things we have announced* [Online]. [Accessed 22 May 2017]. Available at: < <https://www.gov.uk/government/news/autumn-statement-2016-some-of-the-things-weve-announced>>
- Circular Facilities (London) v Sevenoakes District Council* [2005] EWGC 865 (Admin)
- Cheshire CC v Armstrong's Transport (Wigan) Ltd* [1995] Env. LR 62
- Council Directive (EC) (2004), “35 on environmental liability with regard to the prevention and remedying of environmental damage”
- Council Directive (EC) 2006, “12 on waste”
- Council Directive (EC) (2011), “92 on the assessment of the effects of certain public and private projects on the environment”
- Council Directive (EC) (2014) 2014 “52 amending Directive 2011/92/EU on the assessment of the effects of certain public and private projects on the environment Text with EEA relevance”
- Deanesly, C., Evers, A., Mitchener, R., Potter, A. and Stone, H.(2016) Implications of the UK leaving the European Union: Waste Management: Strategic Issues – England and Wales. *Environmental Law and Management*, **8** (3), pp.42-45
- Department for Communities and Local Government (2014) *Guidance: Environmental Impact Assessment*. London: Department for Communities and Local Government
- Department for Communities and Local Government (2015) *Building more homes on brownfield land: Consultation proposals*. London: Department for Communities and Local Government
- Department for Environment Food and Rural Affairs (2017) Water Resources Act [online]. [Accessed 24 May 2017]. Available at:< <http://adlib.everysite.co.uk/adlib/defra/content.aspx?doc=18800&id=18802>>
- Deregulation Act (2015), c.20
- Fogleman, V. (2014a) The contaminated land regime: time for a regime that is fit for purpose (Part 1). *International Journal of Law in the Built Environment*, **6** (2), pp.43-68
- Fogleman, V. (2014b) The contaminated land regime: time for a regime that is fit for purpose (Part 2). *International Journal of Law in the Built Environment*, **6** (2), pp.129-151
- Glasson, J., Therivel, R. and Chadwick, A. (2012) *Introduction to Environmental Impact Assessment*. 4th ed. London:Routledge
- Holmes, S. (2016) Brexit and environmental law: Strategic Issues – England and Wales. *Environmental Law and Management*, **28** (1), pp.37-41
- Housing and Planning Act (2016), c.22
- Housing and Planning Minister (2017) *New measures to unlock brownfield land for thousands of homes* [Online]. [Accessed 22 May 2017]. Available at: < <https://www.gov.uk/government/news/new-measures-to-unlock-brownfield-land-for-thousands-of-home>>
- Kellett, P. (2016) Better regulation, deregulation and environmental law. *Environmental Law and Management*, **27** (5), pp.200-207
- Kent CC v Queenborough Rolling Mill Co Ltd* [1990] 154 J.P. 530
- Lees, E. (2016) The polluter pays principle and the remediation of land. *International Journal of Law in the Built Environment*, **8** (1), pp.2-20
- Lowther, J. (2006) The appropriate person for remediation: successor liability for contaminated land. *Environmental Law and Management*, **18** (3), pp.131-135
- Mamutse, B. (2016) Environmental liabilities in insolvency – an area ripe for reform? *International Journal of Law in the Built Environment*, **8** (3), pp.243-268

Pocklington, D. (2016) Brexit, Article 50 and the future. *Environmental Law and Management*, **28** (2), pp.102-107

R (Bateman) v South Cambridgeshire District Council [2011] EWCA Civ 157

R (Crest Nicholson Residential Ltd) v Secretary of State for Environment, Food and Rural Affairs [2010] EWHC 1561 (Admin)

R (Redland Minerals Ltd) v Secretary of State for Environment, Food and Rural Affairs [2010] EWHC 913 (Admin)

Re Celtic Extraction Ltd [2001] Ch 475

The Conservative and Unionist Party Manifesto (2017) “*Forward Together: Our Plan for a Stronger Britain and a Prosperous Future*”

Reeves, M. (2017) Election of Mayor for the West Midlands Combined Authority. *Combined Authority Returning Officer for the West Midlands*. 4 May 2017

The Environmental Permitting (England and Wales) Regulations (2010), SI 2010/675

Water Resources Act (1991), c.57

Wong, C. and Schulze-Baing A. (2010) *Brownfield residential redevelopment in England What happens to the most deprived neighbourhoods?* York: Joseph Rowntree Foundation

W117: PERFORMANCE MEASUREMENT IN CONSTRUCTION

GROSS MARGIN RISK ASSESSMENT IN CONSTRUCTION PROJECTS: THE INFLUENCE OF INDIRECT COSTS DEVIATIONS

S. Domingues, N. Almeida and V. Sousa

Department of Civil Engineering, Architecture and Georesources, IST-University of Lisbon, Av. Rovisco Pais 1, 1049-001, Portugal

Email: sonia.domingues@tecnico.ulisboa.pt

Abstract: From the contractors' point of view, cost and time deviations affect the financial performance of individual construction projects and ultimately the sustained success of construction companies as a whole. The formal implementation of risk management by construction companies is a way of addressing the construction projects uncertainties, including those affecting their financial performance, maximizing the opportunities and minimizing the hazards. Previous research on quantitative risk assessment of construction projects has focused mainly on the owners' perspective. This communication describes a case study conducted on a large construction company in Portugal, and offers an approach for the quantitative risk assessment, monitoring and reviewing of the gross margin in construction projects due to indirect cost deviations, from the contractor's perspective. The results show that the indirect costs and project duration play an important role on the overall economic performance of construction projects.

Keywords: Gross Margin, Indirect Cost, Quantitative Risk Assessment, Risk Management, Time And Cost Deviations,

1. INTRODUCTION

Financial performance is a major area of concern and a pillar for the sustained success of any organization. Maintaining a profitable activity is therefore one of the major objectives for a construction company: the balance between cost and revenue must be positive, or at least null, in order to ensure business continuity. As so, net profit, which is in general the result of the expression "*total revenue – total expenses*", is an important indicator of the company's performance, and one important management goal is to maximize it (Mohamad et al., 2013).

For construction companies, whose core business are construction projects, the balance between revenues and expenses is evaluated at each project. The costs can be divided into overheads, which account for the costs with the construction company head office and any other cost not directly related with any construction project in particular, and the construction cost, entailing the costs with each construction project. The latter can be further divided into direct, linked to a specific construction activity, and indirect cost, related with the construction project as a whole. The difference between the contract amount and the production costs is frequently reported as the project gross margin. The gross margin entails the (net) profit and, usually, an amount reserved for unforeseen events. This structure is dynamic and uncertainties may result in variations both on the costs and the contract amount (revenue) affecting the project gross margin.

The financial performance depends not only on the cost and revenue amounts, but also on time. In particular, indirect costs such as construction site cost and financial cost (interests and taxes) are time-dependent and have been reported (Mohamad et al., 2013) amongst the most significant factors affecting the gross margin. It is known that time overruns are very frequent in construction projects (Serpella et al., 2014; Idrus et al., 2011; Laryea and Hughes, 2008), but

their consequences in terms of indirect cost are not often addressed. Indirect costs are recognised to be an important part of total construction cost (Ng and Tiong, 2002) and have been shown to be time related and their increase to reduce the gross margin (Domingues et al., 2012). Therefore, cash-flow forecasts are the basis to assess the financial performance and allow the evaluation of the companies' financial liquidity (Ng and Tiong, 2002).

The present communication is a contribution to improve the financial risk management from the contractor's perspective by providing a quantitative evaluation of the indirect costs influence on the gross margin of construction projects. This contribution is mainly on the initial assessment of the financial risk, but also on the monitoring and reviewing phase, by assessing the indirect cost behaviour throughout and up to project completion. The objective is to capacitate construction managers with a quantitative evaluation of risk and thus to support decisions on risk treatment options. These treatment options, such as mitigation of risk or other, are not part of the present study. The scope of the study is the indirect costs variations only, including time-related effects on these variations.

2. METHODOLOGY

Financial forecasts are usually different from the actual results due to the uncertainty underlying every construction project. The effects of the uncertainty on the project objectives in areas of concern such as cost, time or quality represent risks (Thevendran and Mawdesley, 2004; Yildiz et al. 2014). Amongst these risks, cost and time overruns are known to lead to poor financial performance of construction projects (Tah and Carr, 2001; Baloi and Price, 2003; Akintoye and Macleod, 1997; Yildiz et al., 2014; Zeng et al., 2007). As such, various authors have addressed the topic of the risks on the financial performance of construction projects, either dealing with the cash flow globally (e.g., Jarrah et al., 2007; Kaka and Price, 1991; Kaka, 1996; Kaka et al., 2008; Kenley and Wilson, 1986, 1989), or focusing on cost (e.g., Enshassi et al., 2009; Knight and Fayek, 2000) or on time deviations (e.g., Al-Kharashi and Skitmore, 2009; Assaf and Al-Hejji, 2006) individually.

The majority of the studies to date, use qualitative or semi-quantitative approaches, dealing in many cases with risk identification and their relative importance based on expert opinion. The existing quantitative studies are either conceptual models (e.g., Han and Diekmann, 2004; Knight and Fayek, 2002; Ökmen and Öztaş, 2008, 2010) and/or assume an owners perspective (e.g., Aibinu and Odeyinka, 2006; Creedy et al., 2010; Flyvberg 2007; Flyvberg et al., 2003, 2004; Hegab and Smith, 2007; Kim et al., 2008). However, the differences of the owner's and the contractor's point of view has not been sufficiently addressed. When addressing margin variation it is indeed important to make the distinction, since the project cost for the owner is the revenue for the contractor. For instance, a variation on the quantities of some construction activities can be more costly for the owner, but from the contractor's point of view it can also mean more revenue, if the owner is responsible for the change. These type of changes may affect not only the direct costs of the contractor but also the construction schedule, depending on whether these activities are in the critical path, and thus impact on the indirect costs. From the contractor's perspective, a variation on the revenue does not necessarily imply a variation in the construction project cost, and when it does, it may not be in the exact same proportion. On the other hand, a construction project with no revenue variation can, and often does, have a cost variation.

The proposed methodology is a contribution to fill in this gap. Based on a fault-tree analysis, it provides a framework to evaluate the impact of indirect costs on the contractor's gross margin. Figure 1 presents the fault tree summarizing the main events leading to gross margin variation (positive or negative) in construction projects from the contractor's point of view. Level 1 events (top level event) are cost variation or revenue variation. Level 2 comprises the most relevant events leading to either cost or revenue variations. The overheads were excluded from the cost variation since they are not related to a specific project but to the overall activity of the company.

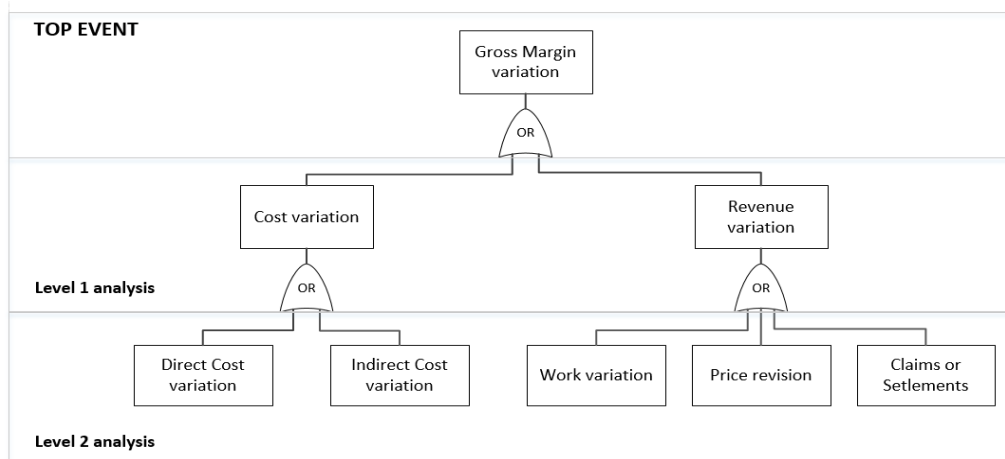

Figure 18: Fault-tree of events leading to gross margin variation in construction projects.

Revenue variation usually occurs with the existence of differences in work quantities, derived from mistakes in measurements or change orders. It can also occur due to price revision (when bid prices are updated accordingly to the market fluctuations) or has a result of claims or settlements (where compensations are due for maintaining the financial balance of the contract).

A cost variation event can be triggered either from direct or indirect cost variation. Even though these two cost categories are interrelated, it is useful to analyse them separately, since they have different deviation causes. Direct cost cover the resources for producing the construction work (labour, materials, equipment, subcontracts). Indirect costs are related to construction site management and facilities installation and maintenance, which directly depend on construction project time, and also related to insurances, bank or deposit guarantees, legal contract or finance fees.

3. CASE STUDY

The case study is based on an initial sample of 67 construction projects of a large Portuguese construction company. Domingues et al. (2012) observed that 96% of these projects suffered schedule overruns, with the majority having additional duration of more than 50% of their initial time estimate. Within the subset of projects that experienced time overruns, 73% had a negative gross margin variation, for which the indirect cost increase contributed.

In order to gain insight on this variations, a sub-sample of construction projects was selected, according to the following constraints: i) construction site located in Portugal; ii) contract value over 1 million euro; iii) no association with other contractors; iv) projects started and finalized

between 2004 and 2014; v) available detailed analytical accounting information; and vi) information on cost estimation for bid closure. The appliance of these constrains, resulted on a restricted sample of 17 projects.

The restricted sample is composed by 10 building projects, 5 transportation infrastructure construction projects (roads and railroads), one water supply construction project and one platforms construction project. Some of the analysis presented ahead were made by grouping the projects according to these characteristics, resulting in two groups: one group, for the 10 building projects and another for the 5 transportation infrastructure construction projects. However, in this second group, one of the projects was ruled out from the observations since it presents a different behavior within the projects in his group (significantly higher deviations and different time-behavior), as so, the results presented for the roads and railroads group were obtained from a subset of 4 cases. The remaining 2 projects on the restricted sample (water supply and platforms) couldn't be grouped, since they have different natures. This restricted sample allows a better understanding on how past projects information can be used as a tool for the assessment, treatment and monitoring of gross margin related risks in construction projects. Despite the limited application for deriving statistical probabilities due to its size, the restricted sample enables the demonstration of a methodological approach for developing a framework for the gross margin risk management.

To measure and categorize the deviations that lead to gross margin variation, the information on final cost and revenue for the 17 construction projects was gathered from analytical accounting data and the estimated cost and revenue were collected from each project's bid closure files. The gross margin variations were obtained by comparing the initial estimates with the final costs and revenue and the comparisons were done both in relative and absolute terms. Gross margin variation was measured in relative terms, by the expression: *Gross Margin variation (%) = Predicted gross margin / Predicted revenue - Final gross margin / Final revenue*. As for indirect cost, its variation was measured both in relative and absolute terms. The relative variation of indirect cost, was measured by the expression: *Final Indirect Cost/ Final Work Revenue - Estimated Indirect Cost/ Estimated Work Revenue*. The value of *Work Revenue*, was obtained by summing the initial contract revenue with the change orders revenue and price revisions revenue. The principle assumed is that indirect cost is part of the work cost payed by the owner, hence, whenever there is a variation on the contract value, there should be a proportional variation in indirect cost, so that its percentage towards contract value stays equal. Price revision was also considered in this equation, since it reflects the costs update in time, therefore, in can also be applied to indirect cost prices. The indirect cost absolute variation, measured in relation to initial estimates, was also considered in the study as it was necessary to analyse level three events of the fault-tree.

4. RESULTS AND DISCUSSION

4.1 Influence of indirect cost variations in gross margin

Table 1 resumes the results for indirect cost variation on the 17 construction projects of the restricted sample. All the cases present indirect cost variation. In 88,2% of the cases, this variation represents an increase of its estimated percentage over work revenue.

Even in those cases where the indirect cost increase originated due to the owner's responsibility and, therefore, a financial compensation was due to the contractor, this cost increase always had a direct impact in the gross margin. Therefore, whether the final result was a positive or

negative variation in gross margin, indirect cost increase always meant to the contractor either the occurrence of a threat or the loss of an opportunity.

Table 1: Variation of IC percentage in work revenue.

	Number of cases	percentage of cases
Total Sample	17	
Gross margin decrease	11	64,71%
Gross margin increase	6	35,29%
Indirect Cost increase	15	88,24%
Subset for gross margin decrease		
Indirect Cost increase	11	100,00%
Indirect Cost decrease	0	0,00%
Subset for gross margin increase		
Indirect Cost increase	4 (*)	66,67%
Indirect Cost decrease	2	33,33%

Note: () in two of these projects, the contractor received a financial compensation due to a variation in time, which was the owner's responsibility.*

4.2 Indirect cost variation breakdown

Figure 2 presents the development of the fault-tree presented on Figure 1, by including the frequencies of occurrence of the variation events, whether in total or regarding the effect of these variations in gross margin (GM), and expanding to levels 3 and 4 of the tree. The variation of indirect cost was due either to variation of costs such as warranties, loyalties or taxes (other indirect costs – OIC), or to the variation on the costs accountable to site facilities installation and maintenance and to the management team (IC-FM). The later represent, in average, 93% of total indirect cost for the case study sample. Their variation was triggered by the combination of one or more of the following events: i) the variation of the project's schedule (due to contractor's responsibility, owner's responsibility or both); ii) the variation of the resources cost (either by a difference in their number or their individual cost); and iii) the unfulfillment of the commercial strategies adopted in the bid closure. The commercial strategies include shortening the time of construction, optimization resources usage over the possibility of gaining new construction contracts on the same or related construction project, or reducing the indirect cost by increasing the weight of subcontracting (transferring indirect costs to the subcontractors). Although these assumptions are time or resource related, and their effect is accounted in resources cost variation or time variation cost, they are also represented as a third branch since they contribute to IC-FM variation.

Figure 3 shows the normal distribution of the indirect cost (IC) variation in the restricted sample. It also shows the distribution of the variation of the indirect costs related to the IC-FM and of OIC related to warranties, loyalties or taxes. The two contributions make the total variation of indirect cost. From the analysis of the normal distributions presented in Figure 3, it is possible to infer that the variation of those costs classified as "Other Indirect Cost" plays a minor role on indirect cost variation, despite its 94% frequency of occurrence. In fact, the overall result for this sample tends to be null. On the other hand, facilities and management cost variation, which comprise the time cost and the resources cost variation events, are significantly close to the results of the total indirect cost variation and deserve further analysis.

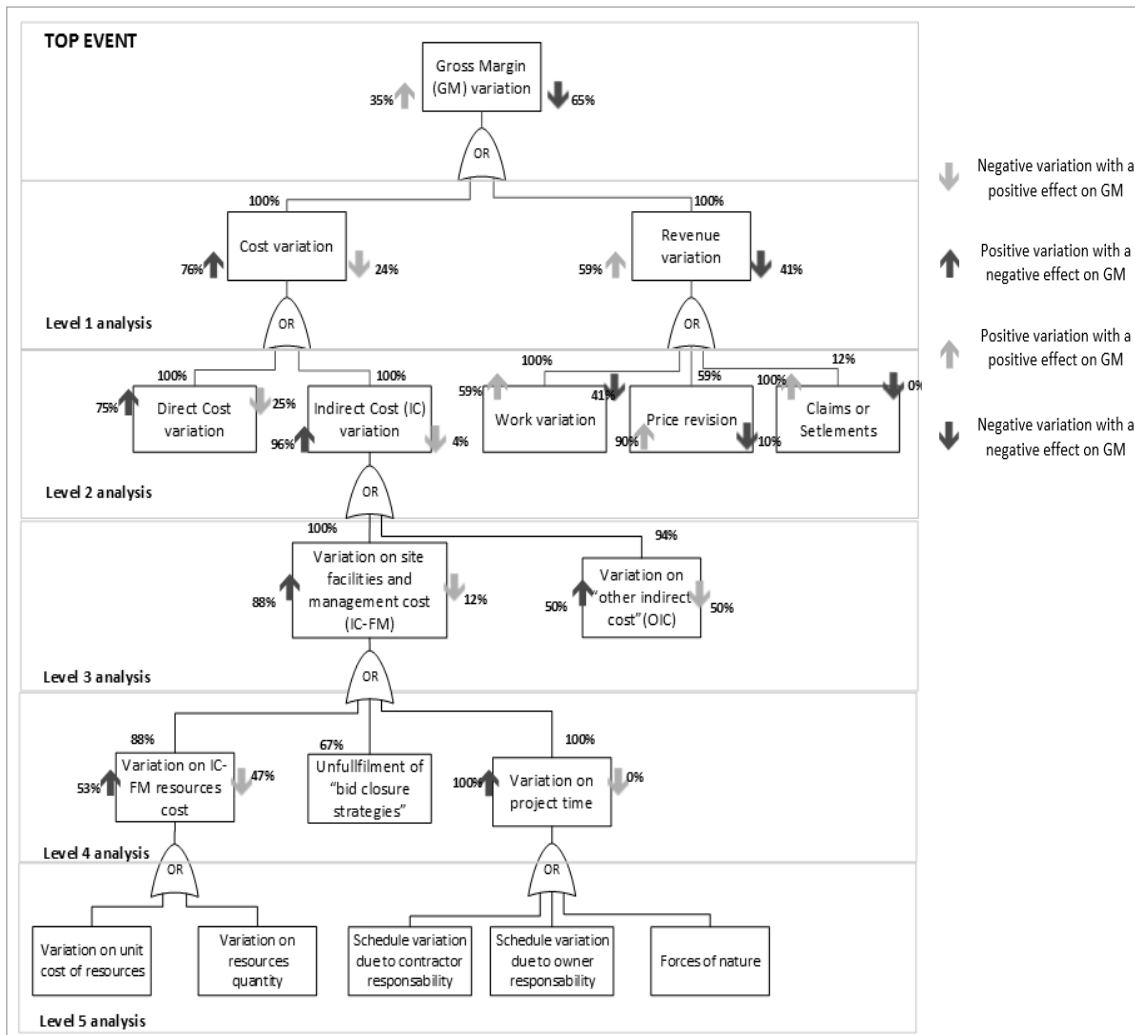

Figure 2: Fault-tree of events leading to gross margin variation in the present case study, showing the development of the "Indirect Cost Variation" event.

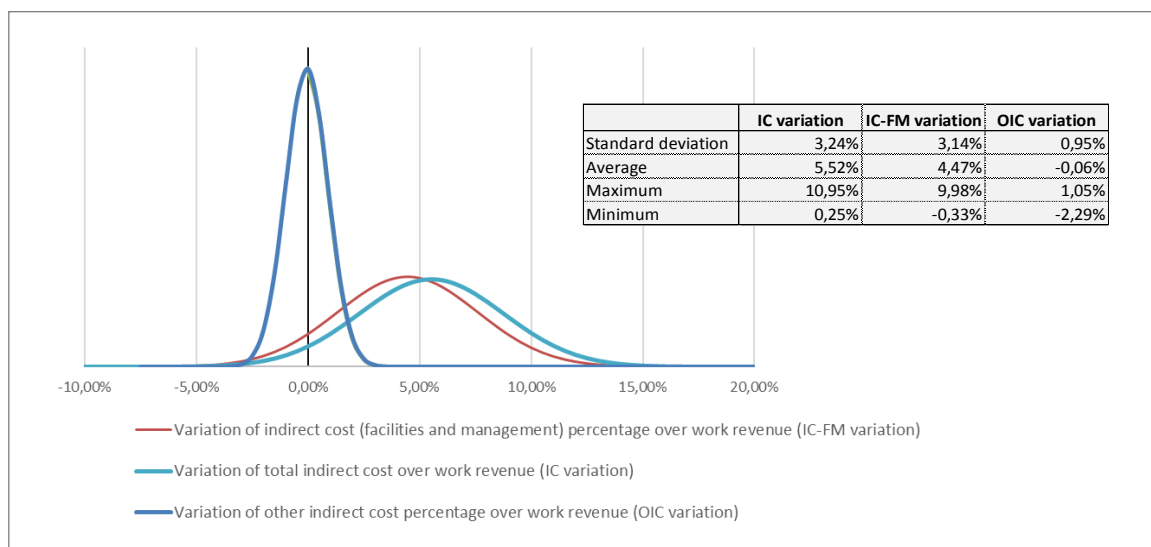

Figure 3: Normal distribution curves for variation of indirect cost percentage (IC%) in work revenue.

Figure 4 presents the individual variation of IC-FM for each construction project, showing its decomposition on the time related or resource related variation. The decomposition was made by comparison of the estimated costs for the predicted project schedule with the actual costs that occurred within that time. This variation was classified as resources cost related. The remaining cost, that occurred in the period from predicted due date until project end, was classified as time related. This enables the observation of the notorious contribution of project time overruns towards the increase of indirect cost.

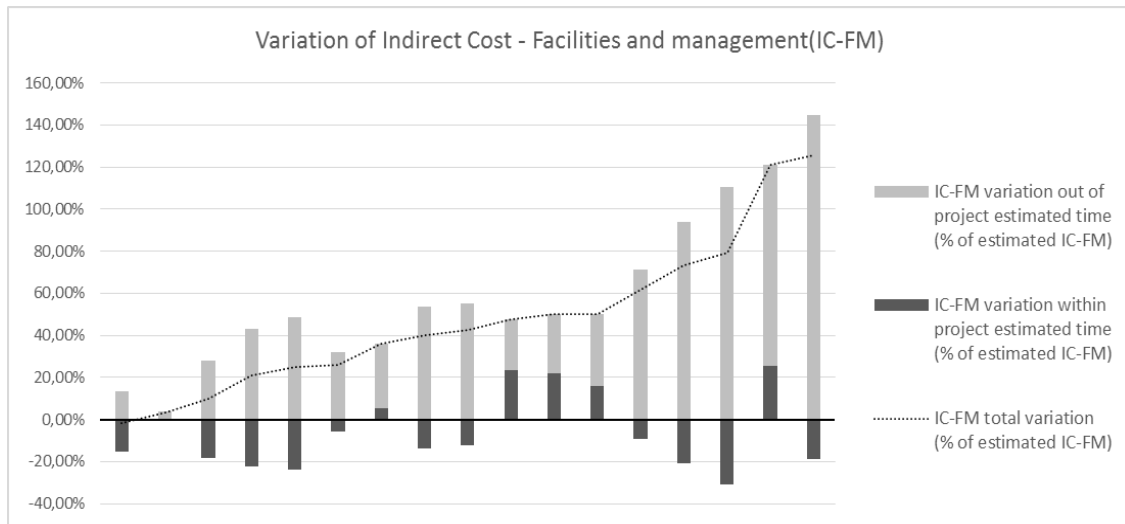

Figure 4: Variation of indirect cost decomposed on time related variation and resources cost related variation.

In fact, schedule overruns, which have occurred in all the cases of the restricted sample are the most influencing factor on indirect cost, as evidenced by the analysis of the contribution of level 3 and 4 events of the fault-tree, to the level 2 event (indirect cost variation), shown on Figure 5.

4.3 Assessing the risk of indirect cost variation

Figure 6, presents the normal distribution curves for facilities and management initial cost estimates, actual cost and cost variations, for all the projects on the restricted sample and grouped by projects nature.

It is clear that the initial estimates are, in the majority of cases, far from the actual results. For the total restricted sample, the average indirect cost percentage for site facilities and management is estimated in 9,4% and its actual value is 13,9%. This represents an average variation of 4,5% of the work revenue spent in indirect cost, and an equal loss of gross margin. In fact, since average gross margin estimate is, for the restricted sample, of 5,6% over work revenue, this average indirect cost increase represents an average loss of 80% of the predicted gross margin. Furthermore, even when not considering the optimizations from the bid strategies, the difference is still of 3,7%, which leads to conclude that the problem is not an aggressive commercial strategy, but can be either a failure on the estimate basis or assumptions, or poor project management during construction phase, amongst others.

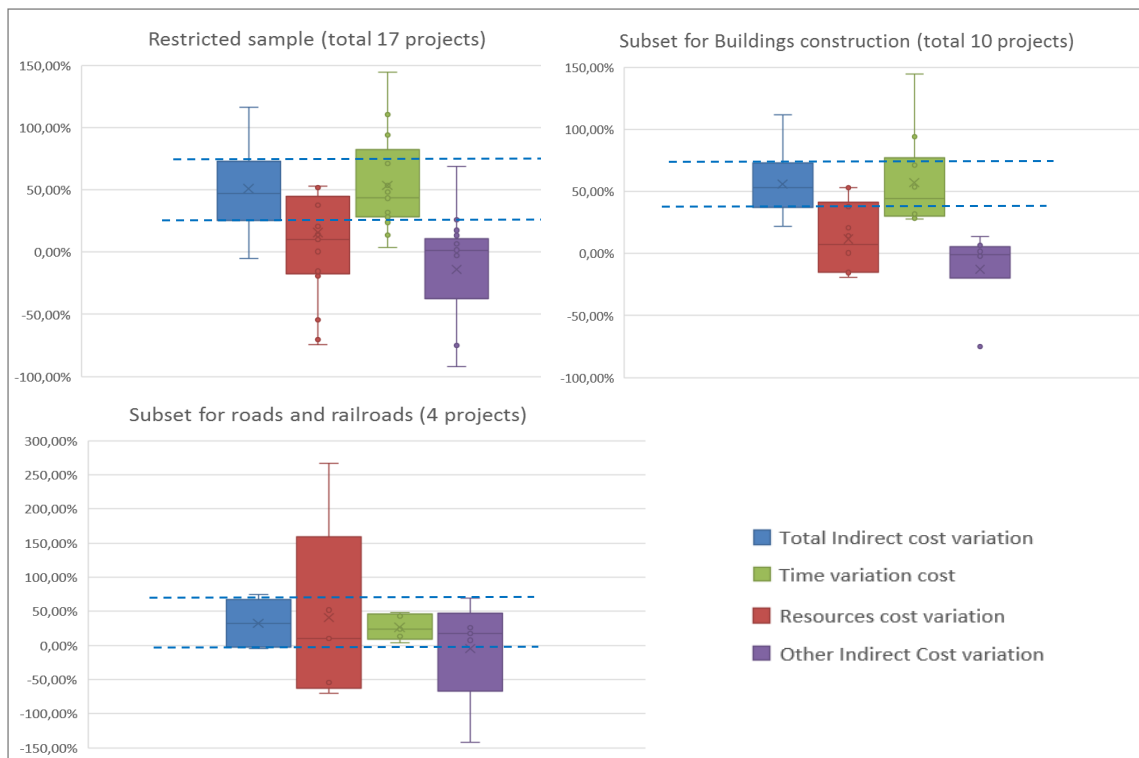

Figure 5: Box and whisker representation of variation of indirect cost (percentage of initial estimate) and its triggering events contribution (measured in percentage of indirect cost estimate). The boxes represent the most frequent values – interquartile range.

The differences between estimates and actual costs are even wider in the subset for buildings construction, raising to a 5,6% average variation of IC%, and an average loss of 85% of this projects predicted gross margin. On the other hand, the subset for roads and railroads projects present smaller variations, with an average of 1,07% of increase in indirect cost, which represents an average loss of 31% of those projects predicted gross margin. The smaller dispersion on the results introduced by using subsets of the sample, when construction projects were grouped according to their nature, suggests that the projects characteristics influence indirect cost estimates and their variation. Therefore, the type of project should be considered in the gross margin variation risk assessment.

However, as presented in section 4.2, it is possible to assess the risk of this variation, for each construction project, right from the bid closure stage, by comparison of the estimated indirect cost with the expected final indirect cost obtained from historical data, according to the project nature. This allows the company management to either correct the estimate or assume an informed risk of its deviation, and consider it on the company's cash-flow projections.

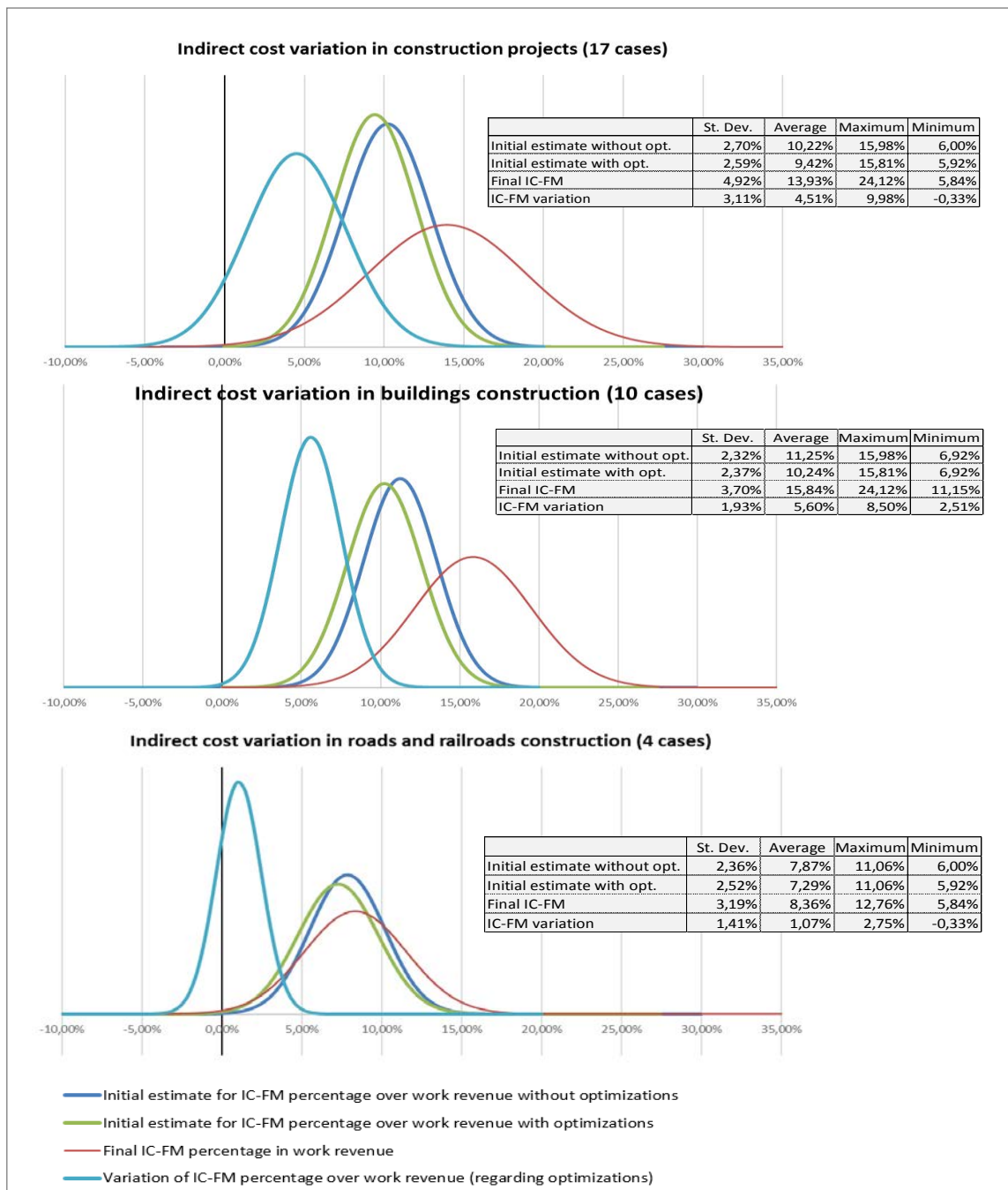

Figure 6: Normal distribution curves for indirect cost percentage in work revenue, only regarding facilities and management cost – estimates, final cost and variation.

4.4 Indirect cost behaviour throughout project completion

Figure 7 shows the behaviour of the indirect cost (site facilities and management) throughout project completion for all the projects in the restricted sample. Three types of behaviours were found according to the final indirect cost variation, therefore, three subsets of cases are presented: I when final actual cost stays under 110% of initial estimate; ii) when final indirect cost stays between 110% and 150% of initial estimate; and iii) when final indirect cost is over 150% of initial estimate. The data for the presented curves was obtained by calculating, for

each monthly period, the total actual indirect cost and the corresponding project completion. Project completion was determined by the expression “Actual direct cost / Total direct cost”.

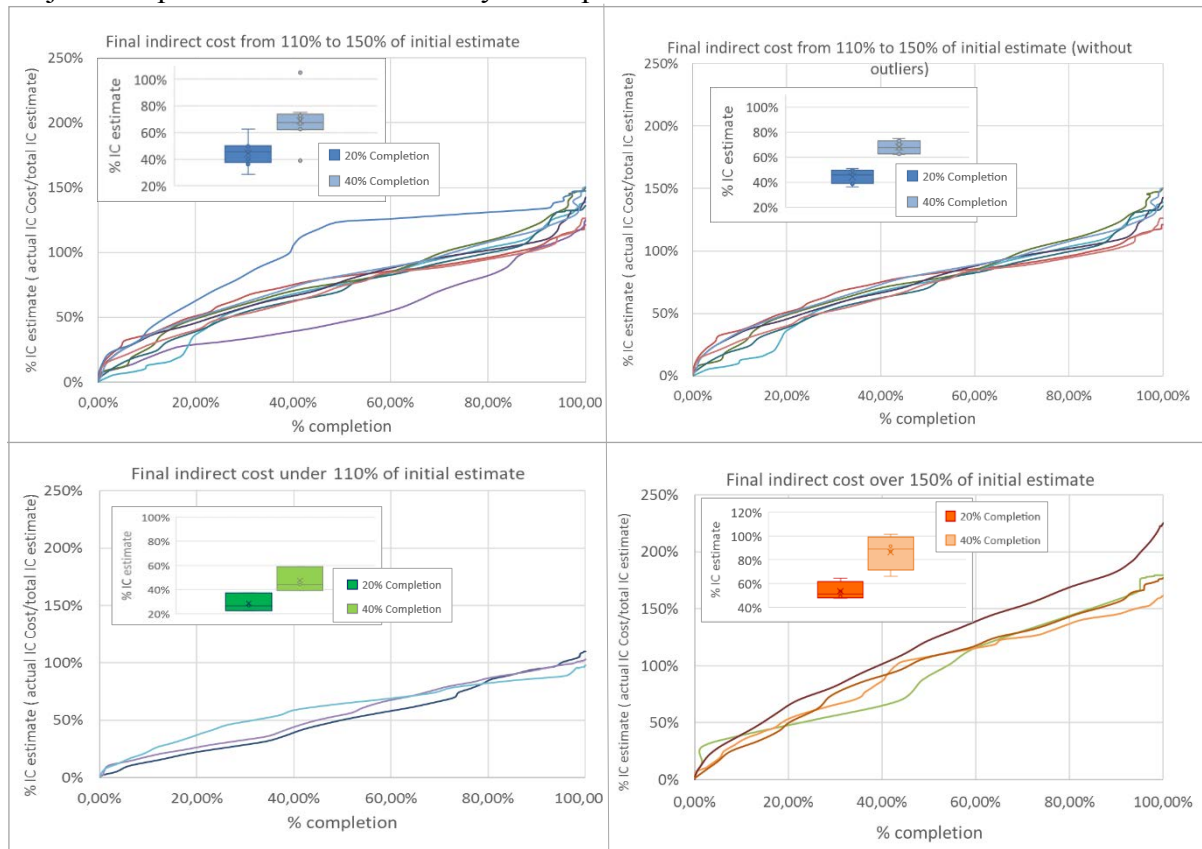

Figure 7: Indirect cost throughout project completion, measured in relation to total estimated indirect cost (site facilities and management only).

The observation of the curves suggest that there is a consistent behaviour in indirect cost throughout project completion, according to its final variation, which is also visible in the analysis made for each subset of curves with a box and whiskers plot at 20% and 40% of project completion (interquartile range is different for each subset). This consistency allows the determination of the expected indirect cost variation by comparison to the project actual indirect cost and the project completion. As an example, for the 20% and 40% project completion, Figure 8 shows the overlapped box and whiskers plots for the three sample subsets.

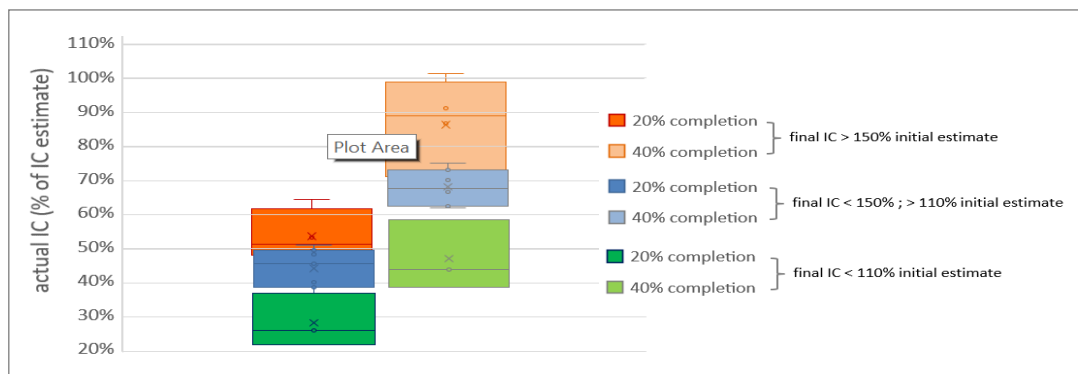

Figure 8: Overlapping box and whiskers plots, for each sample subset: projects with final IC over 150% of initial estimate, from 110% to 150% of initial estimate and under 110% of initial estimate. Results presented for actual indirect cost (measured in percentage of estimated indirect cost) at 20% and 40% project completion.

5. CONCLUSIONS

Financial performance is a major area of concern and a pillar for the sustained success of any organization, and cash-flow forecasts are the basis to assess the financial performance. However, financial forecasts are usually different from the actual results due to the uncertainty underlying every construction project. This paper presented the results of a case study conducted in a construction company, regarding the impact of the indirect cost variation on construction projects gross margin. It aims at enabling gross margin risk assessment since the early stages and throughout a construction project, namely from the estimation phase for the bid price to project completion.

Despite not often addressed, indirect cost variations is a major factor of concern for gross margin objectives in construction projects. In the case study presented in this paper, 88,4% of construction projects showed an increase of indirect costs. This increase, independently from the outcome on the gross margin, always meant to the contractor either the materialization of a threat or the loss of an opportunity. Its impact was, on average, for each project, the loss of 80% of the predicted gross margin. However, it is possible to assess the risk of this variation, for each construction project, right from the bid closure stage, by comparison of the estimated indirect cost with the expected final indirect cost obtained from historical data from similar projects. This allows the company management to either correct the estimate, or assume an informed risk of its deviation and consider it on the company's cash-flow projections.

Construction project risk management can be enabled by the observation of past experiences. The study presented in this paper shows that it is possible to infer the predicted indirect cost variation by comparison with past results, in a given point of the project completion, of the percentage of actual indirect costs measured towards total indirect cost estimate. This allows the project manager and the company management either to act upon the causes that may be driving the expected deviations, or to assume this risk, having better awareness of its possible impact.

Gross margin deviations usually have a negative impact on the construction companies' financial stability. Addressing this problem involves risk assessment, monitoring and reviewing activities. It is of the utmost importance to understand the risk root causes in order to enable its treatment. This paper shows that, for a representative sample of construction projects in Portugal, the most significant aspect in indirect cost deviation is time deviation. Although time overruns are known to be frequent and are often addressed in literature, their impact on the construction projects margin has not yet been sufficiently addressed. Indirect cost increase is one of those impacts. This time related cost increase was indeed found to be the major cause for indirect cost variation. The results and the analysis offered in this paper enables a better understanding of indirect cost variation and of the risk treatment options related with gross margin deviation.

REFERENCES

- Aibinu, A. A. & Odeyinka, H. A., 2006. Construction delays and their causative factors in Nigeria. *Journal of Construction Engineering and Management*, 132(7), pp. 667-677.
- Akintoye, A.S. & Macleod, M.J., 1997. Risk analysis and management in construction. , 15(1), pp.31-38.
- Al-Kharashi, A. & Skitmore, M., 2009. Causes of delays in Saudi Arabian public sector construction projects. *Construction Management and Economics*, 27(1), pp. 3-23.
- Assaf, S. A. & Al-Hejji, S., 2006. Causes of delay in large construction projects. *International Journal of Project*

- Management*, 24(4), pp. 349-357.
- Baloi, D. & Price, A.D.F., 2003. Modelling global risk factors affecting construction cost performance. *International Journal of Project Management*, 21(4), pp.261–269.
- Domingues, S., Almeida, N.M. de & Sousa, V., 2012. Gestão do Risco - A Perspectiva da Empresa de Construção. In Universidade de Coimbra, ed. Congresso Construção 2012.
- Enshassi, A., Al-Najjar, J. & Kumaraswamy, M., 2009. Delays and cost overruns in the construction projects in the Gaza Strip. *Journal of Financial Management of Property and Construction*, 14(2), pp. 126-151.
- Flyvbjerg, B., 2007. Cost overruns and demand shortfalls in urban rail and other infrastructure. *Transportation Planning and Technology*, 30(1),pp. 9-30.
- Flyvbjerg, B., Holm, M. K. S. & Buhl, S. L., 2003. How common and how large are cost overruns in transport infrastructure projects? *Transport Reviews*, 23(1), pp. 71-88.
- Flyvbjerg, B., Holm, M. K. S. & Buhl, S. L., 2004. What causes cost overrun in transport infrastructure projects? *Transport Reviews*, 24(1), 3-18.
- Han, S. H. & Diekmann, J. E., 2004. Judgment-based cross-impact method for predicting cost variance for highly uncertain projects. *Journal of Construction Research*, 5(2), pp. 171-192.
- Hegab, M. Y. & Smith, G. R. 2007. Delay time analysis in microtunneling projects. *Journal of Construction Engineering and Management*, 133(2), pp. 191-195.
- Idrus, A., Nuruddin, M.F. & Rohman, M.A., 2011. Expert Systems with Applications Development of project cost contingency estimation model using risk analysis and fuzzy expert system. *Expert Systems With Applications*, 38(3), pp.1501–1508.
- Jarrah, R., Kulkarni, D. & O'Connor, J. T., 2007. Cash flow projections for selected txdot highway projects. *Journal of Construction Engineering and Management*, 133, pp. 235–241.
- Kaka, A. P. & Price, A., 1991. Net cash flow models: are they reliable? *Construction Management and Economics*, 9, pp. 291–308.
- Kaka, A. P. 1996. Towards more flexible and accurate cash flow forecasting. *Construction Management and Economics*, 14(1), pp. 35–44.
- Kaka, A., Odeyinka, H. A. & Lowe, J., 2008. An evaluation of risk factors impacting construction cash flow forecast. *Journal of Financial Management of Property and Construction*, 13(1), pp. 5–17.
- Kenley, R. & Wilson, O., 1986. A construction project cash flow model - an ideographic approach. *Construction Management and Economics*, 4(3), pp. 213–232.
- Kenley, R. & Wilson, O., 1989. A Construction Project Net Cash Flow Model. *Construction Management and Economics*, 7(1), pp. 3–18.
- Kim, D. Y., Han, S. H. & Kim, H., 2008. Discriminant analysis for predicting ranges of cost variance in international construction projects. *Journal of Construction Engineering and Management*, 134(6), pp. 398-410.
- Knight, K. & Fayek, A. R., 2000. A preliminary study of the factors affecting the cost escalation of construction projects. *Canadian Journal of Civil Engineering*, 27, pp. 73-83.
- Knight, K. & Fayek, A. R., 2002. Use of fuzzy logic for predicting design cost overruns on building projects. *Journal of Construction Engineering and Management*, 128(6), pp. 503-512.
- Laryea, S. & Hughes, W., 2008. How contractors price risk in bids: theory and practice. *Construction Management and Economics*, 26(9), pp.911–924.
- Mohamad, H. H., Ibrahim, A. H. & Massoud, H. H., 2013. Assessment of the expected construction company's net profit using neural network and multiple regression models. *Ain Shams Engineering Journal*, 4(3), pp.375–385.
- Ng, G.H. & Tiong, R.L.K., 2002. Model on cash flow forecasting and risk analysis for contracting firms. *International Journal of Project Management*, 20(5), pp.351–363.
- Ökmen, Ö. & Öztaş, A., 2008. Construction project network evaluation with correlated schedule risk analysis model. *Journal of Construction Engineering and Management*, 134(1), pp. 49-63.
- Ökmen, Ö. & Öztaş, A., 2010. Construction cost analysis under uncertainty with correlated cost risk analysis model. *Construction Management and Economics*, 28(2), pp. 203-212.
- Serpella, A.F., Ferrada, X., Howard, R. & Rubio, L., 2014. Risk Management in Construction Projects: A Knowledge-based Approach. *Procedia - Social and Behavioral Sciences*, 119, pp.653–662.
- Tah, J.H. & Carr, V., 2001. Towards a framework for project risk knowledge management in the construction supply chain. *Advances in Engineering Software*, 32(10–11), pp.835–846.
- Thevendran, V. & Mawdesley, M.J., 2004. Perception of human risk factors in construction projects: an exploratory study. *International Journal of Project Management*, 22(2), pp.131–137.
- Yildiz, A.E., Dikmen, I. & Birgonul, M.T., 2014. Using Expert Opinion for Risk Assessment: A Case Study of a Construction Project Utilizing a Risk Mapping Tool. *Procedia - Social and Behavioral Sciences*, 119, pp.519–528.
- Zeng, J., An, M. & Smith, N.J., 2007. Application of a fuzzy based decision making methodology to construction

project risk assessment. *International Journal of Project Management*, 25(6), pp.589–600.

LIFE CYCLE COSTING IN OFFICE BUILDINGS: KEY PERFORMANCE INDICATORS FROM DGNB DENMARK

K. Haugbølle¹ and L. Raffnsøe²

¹ Danish Building Research Institute/Aalborg University, Fredrik Bajers Vej 5, 9100 Aalborg, Denmark

² Green Building Council, Frederiksborggade 22, 1360 København K, Denmark

Email: khh@sbi.aau.dk; lau.raffnsøe@dk-gbc.dk

Abstract: The purpose of this paper is to analyse and discuss lessons learned on life cycle costing (LCC) in office buildings certified according to the Danish version of the sustainable certification scheme DGNB. The methodology of this paper is based on an action research approach in which the authors have been actively engaged in developing and implementing the DGNB certification scheme. The findings of this study include sharing key performance indicators on life cycle costing from DGNB certified office buildings. The preliminary results indicate that the construction cost will cover half of the total life cycle costs in a 50 year period, while maintenance and operation costs may cover almost one-third of the total life cycle cost. The remaining one-fifth of the life cycle costs are divided between cleaning costs and supply costs for energy and water at a ratio of some 2:1, which implies that cleaning costs are more important than energy costs. While Danish clients and consultants generally have a strong focus on energy optimisation, this paper would like to suggest a need to redirect the attention of building professionals towards cleaning.

Keywords: Cleaning Cost, Key Performance Indicators, Life Cycle Costing, Maintenance, Sustainability,

1. INTRODUCTION

The Brundtland report (1987) “Our Common Future” set a new agenda for a sustainable development with its focus on a balanced development of the three pillars: environment, social affairs and economics. During the 1980s and 1990s Denmark was taking a leading position on sustainability, but that came to a standstill in the 2000s due to new political priorities. In the late 2000s the construction industry started pushing for a certification scheme for buildings. Among other this led to a thorough investigation of four major certification schemes, namely BREEAM, LEED, DGNB and HQE and a test of each of these on two office buildings (Birgisdottir et al., 2010). Following this foundational work, a joint committee of policy makers, business representatives and researchers was established to formulate the general requirements for a certification scheme in Denmark and to suggest either the development of a new national scheme or the adoption and adaptation of an existing scheme. The choice fell on the German certification scheme DGNB (Deutsche Gesellschaft für Nachhaltiges Bauen). Despite the scheme requiring more resources to do a certification of buildings, it was considered superior to the other schemes because: it is a second-generation scheme; it builds on the European standard for sustainable construction works EN15643; it focuses on performance rather than measures; it embraces a broad definition of sustainability rather than the hitherto prevalent narrow focus on energy and environment; and it weights economics on an equal footing with environment and social quality.

With overwhelming support from the industry, a new organisation Green Building Council Denmark (DK-GBC) was established to manage the DGNB scheme and promote sustainable construction more generally. Today DK-GBC has some 275 members covering the most prominent businesses, academia and public agencies across all the main stakeholders in

construction. The first English translation of the international guideline of DGNB for office buildings was published in 2012 and tested in seven pilot projects. Over the next two years the guideline was revised through several iterations, adapted to Danish building customs, and translated into Danish. Since 2014 the initial focus on office buildings has been expanded to include other building types like hospitals, residential buildings, educational and day care institutions, and urban areas. Further, the system is designed in a flexible manner making it possible to certify other less frequent types of buildings if needed and for major refurbishments. In late 2016 a new version of the guideline for office buildings was published to accommodate for recent changes in the building regulations. In addition, a new guideline on buildings in operation is now under preparation along with updated versions of the other existing guidelines for other types of buildings.

From 2014, the Danish version of the DGNB certification scheme has gradually moved into a more steady state of operation. This gradual development holds promising prospects as new certified projects are pouring in these years. These are not limited to office buildings but also include other building types. Hence, data are now becoming available for the first DGNB certified office buildings in Denmark, which offers a unique opportunity to look into the performance of office buildings in a consistent manner due to the standardised assessment procedure of DGNB.

As pointed out by Cole and Sterner (2000) the limited direct use of life cycle costing in green building design is mainly related to constraints in data accuracy and in current design practices. Hence, the purpose of this paper is to analyse and discuss lessons learned from key performance indicators on life cycle costing (LCC) in office buildings certified according to the Danish version of the sustainable certification scheme DGNB. This will accommodate for a stronger and evidence-based grounding of sustainable design in the future.

2. STATE-OF-THE-ART

This section will provide a brief overview of international standards and guidelines, describe shortly the link between sustainability and life cycle costing, provide an overview of the historical development and present trends in Denmark on life cycle costing, and introduce the use of life cycle costing in the Danish version of the certification scheme DGNB.

2.1 International standards and guidelines

Life cycle costing is about expanding the narrow focus on construction costs to include also the operating costs over time. Applying the principles of life cycle costing provides the ability to see the full picture including benefits and/or losses occurring during different stages of the lifetime of a building. Hence, life cycle costing can improve the decision-making process, ensure long-term thinking and fair comparison of design solutions with different cost profiles over time, and potentially create more attractive facilities.

Life cycle costing (and whole life costing) belongs to the broader field of strategic investment and financing (see e.g. Hedegaard and Hedegaard, 2008). While the term life cycle costing is generally recognised in construction, the term total cost of ownership is more widespread in other business sectors (see e.g. Ellram, 1993) and in the recent European directive on public procurement (Directive 2014/24/EU).

A range of different approaches and tools to manage life cycle costing or whole life costing already exist both nationally and internationally. Two international standards define life cycle costing: the international standard ISO15686 series on service life planning (ISO, 2008) followed by the European standard EN15643 series on sustainability of construction works (CEN, 2012). Part 5 of the standard ISO 15686 defines whole life costing as an:

“economic assessment considering all agreed projected significant and relevant cost flows over a period of analysis expressed in monetary value. The projected costs are those needed to achieve defined levels of performance, including reliability, safety and availability.” (ISO, 2008: 9)

Several guidelines have also been published over the years including:

- a Norwegian de facto standard for calculating life cycle costs in construction (Bjørberg et al., 1993);
- a comprehensive overview of different LCC models and engineering design issues within various business areas of application (Dhillon, 2010);
- a textbook for engineering students on economic analysis, estimation and management in product development of complex systems (Farr, 2011); and
- a practical guide to selecting materials from a whole life costing perspective (Caplehorn, 2012).

A ratio of 1:5:200 between construction costs, maintenance and operational costs, and business costs has frequently been quoted (Evans et al., 2004). As pointed out by Hughes et al. (2004) it is difficult if not outright impossible to reproduce this ratio. In general, historical analyses of building operations and maintenance costs are rare, but Bejrums et al. (1996) is a notable exception. A recent review of 45 peer-reviewed papers by Goh and Sun (2016) suggests that there is a renewed interest for LCC calculations, but much work still needs to be done towards extending LCC to include considerations for sustainability.

2.2 LCC and sustainability

As pointed out by Haapio (2008) examples that link life cycle costing, service life planning and environmental assessments are not very widespread. When it comes to the economic effects of sustainable construction through the use of LCC calculations, the government of California at Sustainable Building Task Force in 2003 conducted a study of the economy of green buildings (Kats et al., 2003). Data has been collected from 25 LEED certified office buildings and eight LEED certified schools located in the United States. Construction costs are compared with the costs of the same buildings, if they had been listed as conventional buildings. It is concluded that:

“In the most comprehensive analysis of the financial costs and benefits of green building conducted to date, this report finds that a minimal upfront investment of about 2 per cent of construction costs typically yields life cycle savings of over 10 times the initial investment. For example, an initial upfront investment of up to \$100,000 to incorporate green building features into a \$5 million project would result in a savings of at least \$1 million over the life of the building, assumed conservatively to be 20 years.” (Kats et al., 2003: 7)

A later study of 30 schools in USA examined the additional costs of building "green" and the effects on life cycle costs compared to traditional building (Kats, 2006). The increased costs of construction are less than 2 per cent and provide economic benefits that are 20 times greater. However, most gains will benefit society through better education, while only a small part of these gains in terms of e.g. reduced costs for consumption of energy, water and health insurance ends at the school. Nonetheless, these gains are four times higher than the additional costs.

In England, studies of "green office building" has demonstrated that the benefits of greater productivity and lower labour costs for the company amounts to six times the energy savings over a 20 years period (Edwards, 2006). Hence, there is considerable more to gain on productivity and health than on reduced energy costs.

Additional costs of building green can be reduced by choosing the right strategy at the planning and design stage (Syphers, 2003). In previous practice, the extra cost of new construction varied between 0-2.5 per cent for LEED Silver certification and up to 5-8.5 per cent for LEED Platinum certification. A study in Seattle – one of the leading municipalities on green buildings – documented a downward trend towards lower additional costs over time. In 2000 the additional costs of an LEED Silver certification varied between 4 per cent for large buildings and up to 6 per cent for small projects. In 2003 these costs for all projects was reduced to near zero per cent. It is therefore concluded that it is possible to build at normal costs and obtain a certificate by choosing the right strategy. An appropriate strategy includes careful programming of ambition, additional costs of design, interdisciplinary collaboration, early involvement of contractor and technical contractors, use of energy calculations and attention to daylight and good insulation.

2.3 LCC in Denmark – history and new trends

Life cycle costing has a long history in Denmark. The very first publication on life cycle costing or economic optimisation of insulation was issued by the national building research institute as its very first publication in 1949 (Becher, 1949). Over the years a number of publications on aspects of life cycle costing has been issued by the national building research institute among others on insulation of pipes (Becher and Engelsen, 1957), an SBI Direction on economic assessment of energy-saving measures (Johnsen and Andersen, 1982), an evaluation of ten demonstration projects on life cycle costing (Haugbølle and Henriksen, 2002), tables of service life times (Aagaard et. al., 2013) and the national calculation tool LCCbyg (Haugbølle et al., 2016).

To support the uptake and dissemination of life cycle costing in Denmark, a wide range of initiatives etc. have been taken for the past 20 years or more by many other actors in Danish construction. These include among others:

- the release of manuals and guidelines for designers and managers,
- development of ICT-based calculation tools,
- publication of reference books about service life times and depreciation tables for cooperative-housing and insurance,
- national standards for overall financial calculations, operating principles, and calculation of economic indicators,

- establishment of databases with key figures for the construction and operation of public housing, building defects and benchmarking of facility management, especially for office buildings, and
- collecting and evaluating experiences and lessons learned from national as well as international outlooks to for example England and the other Nordic countries.

Applying the principles of life cycle costing has for several years been mandatory in both social housing projects and governmental building projects. However, the approaches in the two separate sectors were quite different. While the social housing sector has since 1998 developed and applied a consecutive set of sector-specific tools, the government building agency effectively neglected its obligations to apply and disseminate knowledge on life cycle costing. This negligence, however, recently came to a sudden end when the agency was criticized in strong terms by the Danish National Audit Office and the Danish Public Accounts Committee. Since then, the government building agency has taken action on life cycle costing. These actions have been further fuelled by the recruitment of a new CEO, who came from a municipal building agency with a high profile on sustainability and life cycle costing.

In addition, three other recent trends have stimulated a wider use of life cycle costing in the built environment:

1. New governmental regulation on quality assurance, public-private partnerships and life cycle costing in public construction issued in 2013, which requires all public clients (including municipalities and counties) to apply life cycle costing in projects above certain thresholds.
2. The establishment in 2012 of the certification scheme DGNB adopted by the Green Building Council Denmark for sustainable buildings and urban areas in which economics have a very prominent position.
3. The new European procurement directive from 2014 that supports the use of total cost of ownership (TCO or life cycle costing) as an award criterion in competitive tendering rather than just lowest price.

2.4 LCC in DGNB Denmark

The concept of sustainability applied by the DGNB certification scheme addresses six criteria groups, which is further divided into approximately 50 individual criteria. The six criteria groups cover:

- environmental quality,
- economic quality,
- sociocultural and functional quality,
- technical quality,
- process quality, and
- site quality.

Each criteria and criteria group is scored according to predefined weights summing up to a total of 100 per cent. The criteria group on economic quality accounts for 22.5 per cent of the total score.

In the Danish version of the DGNB certification scheme, life cycle costing (LCC) is one of three criteria within the criteria group of economic quality. The other two criteria are flexibility and adaptability, and robustness. The LCC criteria accounts for 40 per cent of the score of economic quality, hence this one criteria alone accounts for 9.6 per cent of the total score in the Danish version of DGNB.

In order to ease the work with LCC calculations in certified projects and ensure compliance with the calculative assumptions, an LCC tool was developed specifically for DGNB certification by the national building research institute in cooperation with Green Building Council Denmark. The tool was developed as a spreadsheet solution based on Microsoft Excel.

3. METHODOLOGY

3.1 Action research approach

The methodology of this paper is based on an action research approach in which the authors have been actively engaged in developing and implementing the DGNB certification scheme in Denmark. The first author has been responsible for developing the spreadsheet tool for life cycle costing, executing educational activities and performing external third-party audits (conformity checks). The second author has been employed in Green Building Council Denmark since 2014 with the main responsibility of developing the DGNB guidelines and tools, planning and executing educational activities, managing the entire audit procedure, and undertaking promotional activities.

Action research as a concept was introduced by social psychologist Kurt Lewin (1946). He described action research as a spiral with each turn consisting of three stages: planning, action, and reflection on the results of the actions. In more current versions, this spiral has been extended to include other steps like problem formulation, research/study process, analysis and interpretation of results, and communication of results. Action research or participatory action research is an experimental type of research of interventions, development, and change in and of a practical situation. In action research, researchers work collaboratively with practitioners in the development of research questions, methodology, participatory processes and analysis to systematically implement and evaluate a change in practice. Participatory action research is not tied to any particular method, but can be seen as an empowering context where several methods may be included or even created as part of the research project (Launsø and Rieper, 2005).

3.2 Data material and analysis of data

The data material for this paper has been produced as part of the ongoing efforts of the DGNB certification scheme. This means that all data are gathered in a systematic manner from the same source.

The number of certified projects included in the study is rather small and therefore no advanced statistical tests have been applied in the analysis of the data. The number is small due to a deliberate highly selective approach in which only certified projects with the same overall characteristics were included. More projects could have been included but they were left out to ensure that they did not obfuscate the results due to differences in building types, time, version

of certification manual etc. Further, pilot projects with somewhat different calculative assumptions were left out even if the projects could have been recalculated using revised assumptions.

In total, 10 building projects were included. All projects are office buildings constructed in 2015-16. They all follow the directions set out in the DGNB guideline NBK2014 for new office buildings, version 2014. The size of the projects spans from 1,500 m² to 16,000 m² with an average of some 7,000 m². All projects pass the threshold for being certified at the highest possible level (Gold, now labelled Platinum) with regard to the criteria for economic quality, but the projects do not necessarily achieve the same overall score. The study only includes data from final certifications of projects, while preliminary certifications are left out.

3.3 LCC assumptions by DGNB Denmark

The life cycle costs are calculated using the method of net present value (NPV). It should be noted though that only costs and not revenues are included. Doing LCC calculations require a number of assumptions that are decisive for the results. Hence, DK-GBC established a technical committee for each building type to discuss and inform the selection of appropriate general calculation assumptions with regard to the calculation period, discounting rate and price developments for different cost groups. Further, costs and price development rates are calculated as nominal costs. The general calculation assumptions are:

- Calculation period: 50 years.
- Year of calculation: year of obtaining DGNB certificate.
- Nominal discount rate (flat): 5.5 per cent.
- General price development: 2 per cent pro anno.
- Potable water and sewage price development: 3 per cent pro anno.
- Energy price development: 4 per cent pro anno.

The LCC calculations of DGNB include four main cost groups:

- Construction costs.
- Costs of maintenance and replacements.
- Supply costs.
- Cleaning costs.

Construction costs are calculated per m² gross floor area. Only 50 per cent of the area of basements is included to reflect the lower unit price of these areas. As construction and maintenance costs vary with the location of the project, these costs are normalised with a correction factor for location in the interval of 0.85-1.05 in line with what is customary in Denmark. The construction cost groups is based on the most widespread and well-known classification system named SfB, which has been in operation in Denmark since its development in Sweden in the 1950s (Byggecentrum, 1988). Only the first six main SfB groups are included, while costs for site, consultancy fees, furniture and equipment, VAT etc. are excluded:

- (1.) Substructure.
- (2.) Structure, primary elements.

- (3.) Completions.
- (4.) Applied finishes.
- (5.) Sanitation and HVAC services.
- (6.) Electrical services.
-

The calculation of costs of maintenance and replacement is done according to the following principles:

- The reference service life time of building components follows the official table of service life times provided by the national building research institute.
- A component is replaced when its projected life time expires.
- Replacement cost is assumed to be a constant percentage and calculated as 125 per cent of the initial cost to include the costs of both reacquiring a new component and replacing and disposing of the worn out component.
- Maintenance cost is set as a constant percentage for each building component, but varying from one building component to another.

The supply costs are calculated as follows:

- Amounts of water and sewage are calculated using the DGNB ENV2.2 water and sewage calculator.
- The amount of energy for heating as well as electricity consumption for building services is extracted from the Be15 calculations that are mandatory to do in order to demonstrate compliance with the building regulations.
- Photovoltaic production of electricity is not included.

The cleaning costs are calculated based on standard cost of cleaning per m² and with a standard frequency. They are calculated for three subgroups:

- Grounds (although not applicable for offices).
- Building, exterior.
- Building, interior – spaces/type of rooms.

4. RESULTS

The LCC calculations of recently DGNB certified office buildings in Denmark has provided a number of observations and lessons learned with regard to the main cost drivers. Based on the assumptions specified in the previous section, Figure 1 illustrates the relative distribution of net present value divided into the four main cost groups for office buildings.

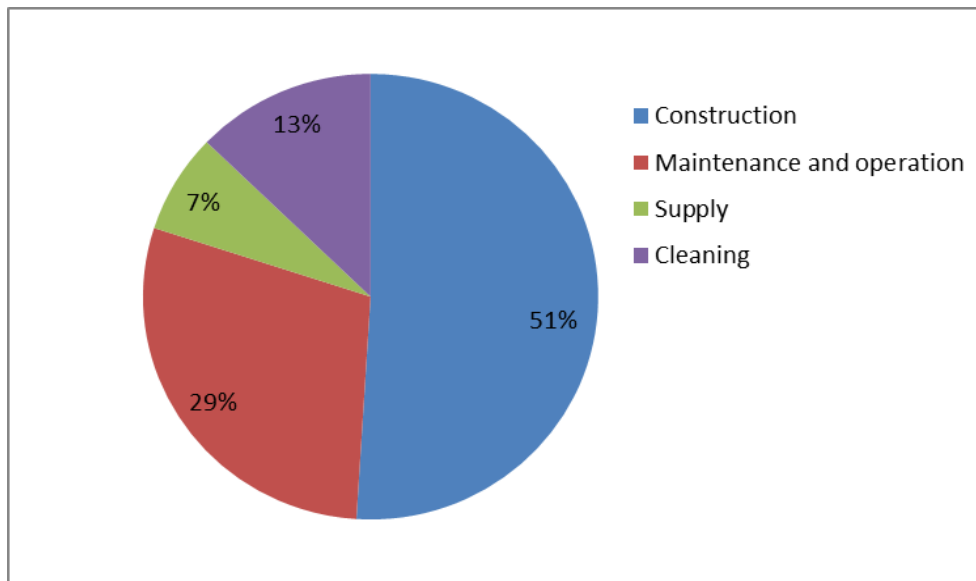

Figure 1: Distribution of main cost groups (per cent)

In a 50-year perspective the life cycle costs of each of the four main cost groups seem to be distributed with half of the NPV on construction costs, close to 1/3 of the NPV on maintenance and operational costs, and the remaining 1/5 of the NPV on supply and cleaning costs. The relative distribution of supply costs versus cleaning costs seems to be 1:2, meaning that cleaning costs are approximately twice as high as supply costs in total (water, sewage and energy including electricity consumption). Hence, construction costs seem to be of the same magnitude as maintenance and operational costs taken together. Business costs will surely outnumber both, but these costs are not included in the DGNB scheme.

The inventory of gross floor area, cleaning area etc. is essential as this is the denominator used in the calculations. In particular, special attention needs to be paid to the difference in costs associated with different types of space. On one hand e.g. parking areas and basements have comparably low construction costs and operational costs. On the other hand, other types of areas e.g. surgical theatres and laboratories with high intensity of installations have much higher costs than average with regard to both construction costs and operational costs. Hence, it seems prudent to differentiate between different types of spaces in the LCC calculations as the relative distribution between low, medium and high cost spaces will impact the resulting NPV.

Figure 2 shows the absolute net present values for each of the four main cost groups as well as the total sum in DKK/m². Figure 2 also shows the dispersion, in terms of the range of a set of data, as the difference between the largest and the smallest values for each of the four main cost groups as well as the total (marked with a black vertical line).

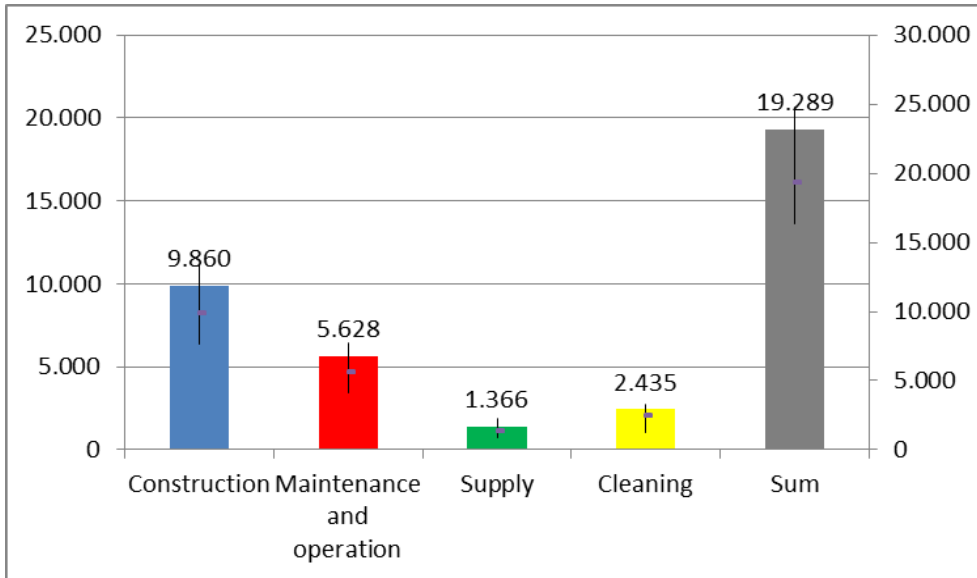

Figure 2: Distribution of main cost groups and the range of values (DKK/m²)

Figure 3 shows the distribution of construction costs on the six main groups of the SfB classification, while Figure 4 shows the distribution of the maintenance and operation costs of the same six groups. Taken together, Figure 3 and Figure 4 indicate some notable observations. First, while the first three SfB groups (substructure, structure and completions) account for more than half of the construction costs, they only account for 1/3 of the maintenance and operation costs. Second, the maintenance and operation costs of applied finishes are twice the construction costs. Third, the last two SfB groups on technical installations (sanitation and HVAC services and electrical services) accounts for approximately 1/3 of the construction costs but make up half of the maintenance and operation costs.

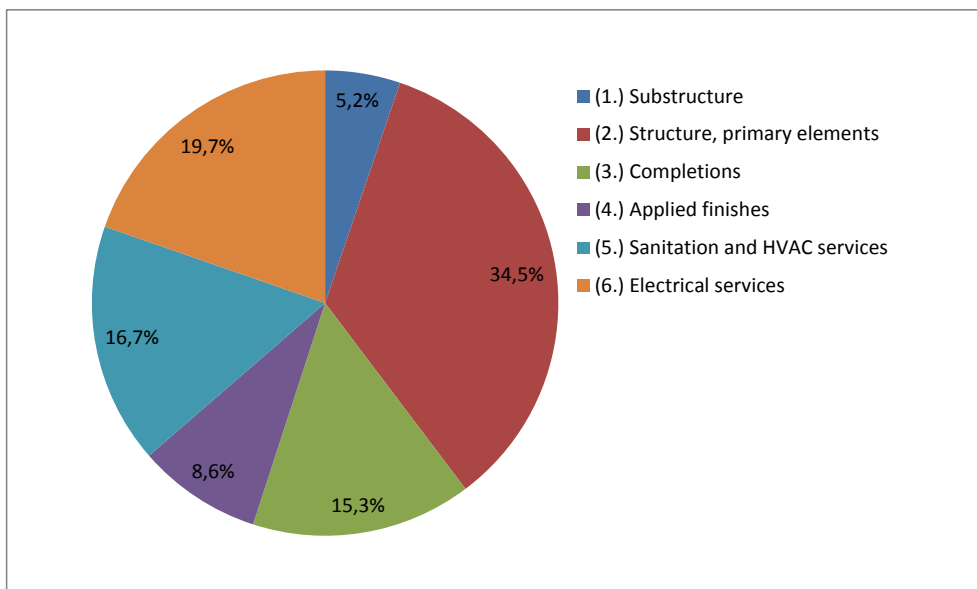

Figure 3: Distribution of construction costs (DKK/m²)

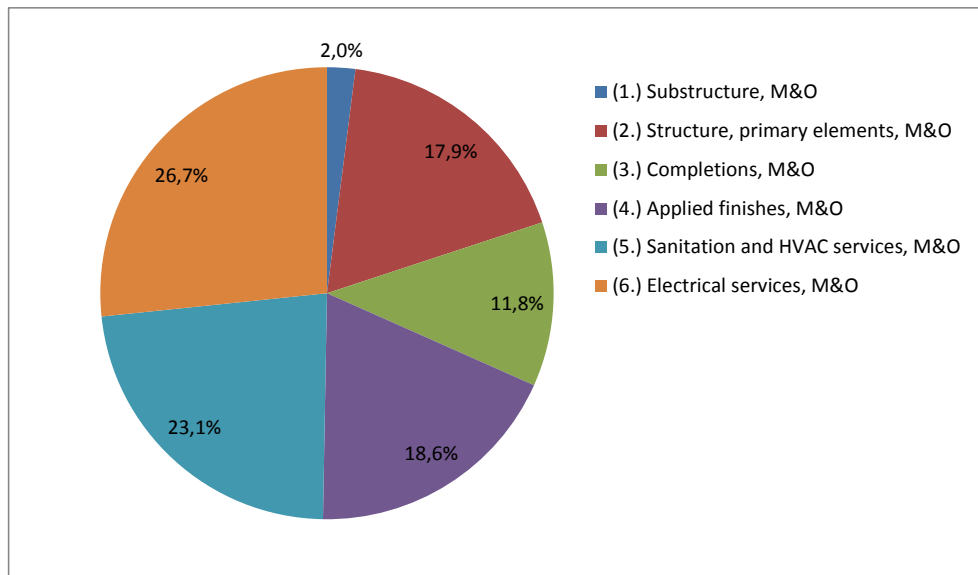

Figure 4: Distribution of maintenance and operation costs (DKK/m²)

The analysis of the key performance indicators in Figure 3 and Figure 4 has demonstrated that certain construction cost drivers compared to maintenance and operation costs are more important. In particular, special attention should be paid to technical installations with their relatively short lifetime expectancy and high maintenance and operation costs. Similarly, applied finishes are driving maintenance and operation costs disproportionately compared to the construction costs. This phenomenon is even more pronounced when the cost of cleaning is added.

5. CONCLUSIONS

The preliminary results presented here indicate that construction costs cover half of the life cycle costs in a 50 year period, while maintenance and operation costs may cover close to one-third of the life cycle cost. The remaining one-fifth of the life cycle costs are divided at a ratio of some 2:1 between cleaning costs and supply costs for energy, water and electricity, which implies that cleaning costs are more important than energy costs. While Danish clients and consultants generally have a strong focus on energy optimisation, this paper would like to suggest a need to refocus the attention of building professionals towards cleaning.

While the certification scheme DGNB Denmark is now gathering many valuable insights and is sharing them with the DGNB consultants as well as the construction industry in general, there are still a range of areas that needs attention in the future. To mention one, evidence-based experiences on the building envelope – one of the most important parts of any building – are still in short supply with regard to comprehensive optimisations taking into account sun shading systems, cleaning of windows, heating and cooling, indoor climate issues etc.

As the numbers of certified projects are increasing rapidly the authors are looking forward in the near future to be able to report on new developments and to solidify key performance indicators, not only with regard to office buildings but also when it comes to other types of buildings.

6. REFERENCES

- Becher, P., 1949, *Økonomisk varmeisolering (in Danish: Economic Optimisation of Heating Insulation)*. Statens Byggeforskningsinstitut Rapport Nr. 1, København, Teknisk Forlag.
- Becher, P. and Engelsen, K., 1957, *Økonomisk rørisolering (in Danish: Economic Pipe Insulation)*. Statens Byggeforskningsinstitut. Rapport nr. 18, København, Teknisk Forlag.
- Bejrums, H., Hanson, R. and Johnson, B. G., 1996, *Det levande husets ekonomi: livscykeleconomiska perspektiv på drift och förnyelse (in Swedish: Economics of the living house: life cycle economics perspective on operation and renewal)*, Stockholm, Byggeforskningsrådet.
- Birgisdóttir, H., Hansen, K., Haugbølle, K., Hesdorf, P., Olsen, I. S., and Mortensen, S. A., 2010, *Bæredygtigt byggeri: Afprøvning af certificeringsordninger til måling af bæredygtighed i byggeri (in Danish: Sustainable construction: Testing of certification schemes for measuring sustainability in construction)*, København, Byggeriets Evaluerings Center.
- Bjørberg, S., Eide, I. and Stang, E., 1993, *Årskostnader. Bok 1. Beregningsanvisning for bygninger (in Norwegian: Annual costs. Book 1. Calculation instructions for buildings)*, Oslo, Norges Byggeforskningsinstitut & Rådgivende Ingeniørers Forening (RIF).
- Byggecentrum, 2012, *BC/SfB 1988 Bygningsdelstavle (in Danish: BC/SfB 1988 Building component classification table)*, København, Byggecentrum.
- Caplehorn, P., 2012, *Whole life costing: a new approach*, London & New York, Routledge.
- CEN, 2012, *EN 15643-4:2012 Sustainability of construction works – Assessment of buildings – Part 4: Framework for the assessment of economic performance*, Brussels, CEN – European Committee for Standardization.
- Cole, R. J., and Sterner, E., 2000, Reconciling theory and practice of life-cycle costing, *Building Research & Information*, 28(5-6), 368-375.
- Dhillon, B. S., 2010, *Life Cycle Costing for Engineers*, Boca Raton, London & New York, CRC Press.
- DIRECTIVE 2014/24/EU OF THE EUROPEAN PARLIAMENT AND OF THE COUNCIL of 26 February 2014 on public procurement and repealing Directive 2004/18/EC*, Brussels, Official Journal of the European Union.
- Edwards, B., 2006, Benefits of Green Offices in the UK: Analysis from Examples Built in the 1990s, *Sustainable Development*, Vol. 14 (3), 190-204.
- Ellram, L. M., 1993, A Framework for Total Cost of Ownership, *The International Journal of Logistics Management*, Vol. 4 (2), 49-60.
- Evans, R., Haryott, R., Haste, N., and Jones, A., 2004, The long-term costs of owning and using buildings, in Macmillan, S. (ed.), *Designing Better Buildings: Quality and Value in the Built Environment*, Taylor & Francis, 42-50.
- Farr, J. V., 2011, *Systems Life Cycle Costing. Economic Analysis, Estimation, and Management*, Boca Raton, London & New York, CRC Press.
- Goh, B. H. and Sun, Y., 2016, The development of life-cycle costing for buildings, *Building Research & Information*, 44 (3), 319-333.
- Green Building Council Denmark, 2014, *DGNB system Denmark. Manual for Kontorbygninger 2014 (in Danish: DGNB system Denmark. Manual for Office Buildings 2014)*, Frederiksberg, Green Building Council Denmark.
- Haapio, A., 2008, *Environmental assessment of buildings*, Espoo, Helsinki University of Technology. TKK Reports in Forest Products Technology: Series A2.
- Haugbølle, K., and Henriksen, K. R., 2002, *Totaløkonomi: Evaluering af 10 forsøgsbyggerier (in Danish: Life cycle costing: Evaluation of 10 development projects)*. By og Byg Dokumentation Nr. 031, Hørsholm, SBI forlag.
- Haugbølle, K., Sørensen, N. L. and Scheutz, P., 2016, *LCCbyg. Version 2.1.9*. Available at: <http://lccbyg.dk/download> [accessed 19 April 2017]
- Hedegaard, O. and Hedegaard, M., 2008, *Strategic Investment and Finance*, Copenhagen, DJØF Publishing.
- Hughes, W. P., Ancell, D., Gruneberg, S. and Hirst, L., 2004, Exposing the myth of the 1:5:200 ratio relating initial cost, maintenance and staffing costs of office buildings, in: Khosrowshahi, F. (ed.), *Proceedings of the 20th Annual ARCOM Conference*, Heriot-Watt University, 373-381. Available at: http://www.arcom.ac.uk/docs/proceedings/ar2004-0373-0381_Hughes_et_al.pdf [accessed 19 April 2017]
- ISO, 2008, *ISO 15686-5:2008 Buildings and constructed assets - Service-life planning - Part 5: Whole-life costing*, Geneva, ISO – International Standardization Organization.
- Johnsen, K. and Andersen, H. S., 1982, *Økonomisk vurdering af energibesparende foranstaltninger. SBI-anvisning nr. 13 (in Danish: Economic assessment of energy-saving measures. SBI Instructions No. 13)*, SBI forlag, Hørsholm.

- Kats, G. H., Alevantis, L., Berman, A., Mills, A. and Perlman, J., 2003, *The costs and financial benefits of green buildings: a report to California's sustainable building task force*, Sustainable Building Task Force.
- Kats, G. H., 2006, *Greening America's Schools. Costs and Benefits*, U. S. Green Building Council. Available at: <http://www.usgbc.org/Docs/Archive/General/Docs2908.pdf> [accessed 19 April 2017]
- Launsø, L. and Rieper, O., 2005, *Forskning om og med mennesker – forskningstyper og forskningsmetoder i samfundsforskning. 5th edition (in Danish: Research on and with people – research types and research methods in social science. 5th edition)*, Nyt Nordisk Forlag Arnold Busck, Copenhagen.
- Syphers G., Baum M., Bouton D, and Sullens W., 2003, *Managing the Cost of Green Buildings. K-12 Public Schools, Research Laboratories, Public Libraries, Multi-family Affordable Housing*, State of California's Sustainable Building Task Force, the California State and Consumer Services Agency and the Alameda County Waste Management Authority and Consumer Services Agency, State of California. Available at: <http://www.calrecycle.ca.gov/greenbuilding/design/managingcost.pdf> [accessed 19 April 2017]
- Aagaard, N.-J.; Brandt, E.; Aggerholm, S. and Haugbølle, K., 2013, *Levetider for bygningsdele ved vurdering af bæredygtighed og totaløkonomi (in Danish: Lifetime of building components in assessing sustainability and lifecycle costing)*. SBI 2013:30, København, SBI Forlag.

FACTORS INFLUENCING THE OCCURRENCE OF REWORK IN CONSTRUCTION

S. Ndwandwa¹, E. K. Simpeh² and J. J. Smallwood¹

¹ Department of Construction Management, Nelson Mandela University, PO Box 77000, Port Elizabeth, 6031, South Africa

²Department of Construction Management and Quantity Surveying, Cape Peninsula University of Technology, PO Box 1906, Bellville 7535, South Africa

Email: ndwandwa.siya@gmail.com

Abstract: This study investigated the factors influencing the occurrence of rework and the impact on construction productivity so that an effective reduction strategy thereof can be developed. A quantitative approach was adopted and data was collected via a questionnaire survey targeting randomly selected construction professionals and stakeholders in the Nelson Mandela Bay metropolitan area in the Eastern Cape province. A total of 24 participants from both construction firms and consulting firms participated in this study. Descriptive statistics were used to analyse the data. The findings revealed that client induced changes, late design changes, poor communication, insufficient skill levels of construction workers, non-compliance with specification were the major factors influencing the occurrence of rework during construction. The results of the study also revealed that cost overruns, extension of supervision, and quality degradation impacted on project performance because of rework. The empirical research was limited to the Nelson Mandela Bay metropolitan area in the Eastern Cape province; therefore, the result cannot be generalised. Further research relative to other provinces would be useful to determine if similar findings would emerge. The research concludes by recommending that design and construction firms must incorporate all stakeholders in decision-making, particularly with regards to critical path works to reduce the effects of rework on project performance. More so, improving management-worker communication mediums would essentially improve the coordination of work; thus diminishing any chances of errors.

Keywords: Construction, Errors, Omissions, Project Performance, Rework

1. INTRODUCTION / BACKGROUND

The Republic of South Africa (RSA) has a vastly diversified economy with many contributors. Construction is an industry that contributes 3.9% to the country's Gross Domestic Product (GDP) (Statistics South Africa, 2015). This statistic is testament to the economic importance of the construction industry; however, the efficiency of the industry is marred by hindering factors such as rework. Rework is defined by Hwang *et al.* (2009) as the redundant exertion of efforts and misallocation of project resources that result in having to redo a process due to non-conformance to specification at the first time of asking. In a similar vein, Love, Edwards & Irani (2004) described rework as doing something at least one extra time due to non-conformance to requirements. Rework also known as waste, has been considered as non-value adding endemic symptoms that seriously affect the performance and productivity aspects in construction projects.

Han *et al.* (2007) contend that for rework to be successfully managed, it is necessary to identify and classify its root causes. Many researchers (see Hwang *et al.*, 2009; Palaneeswaran, 2006) have insinuated that one of the root causes of rework is often due to the complicated characteristics of the construction processes. This gives rise to multiple sub-components which result in the phenomenon of rework. For instance, O'Conner and Tucker (1986) stated that engineering rework is a result of owner scope and specification changes, design errors,

procurement errors, poor construction techniques and poor construction management techniques. Hwang *et al.* (2009) also revealed that design errors and omissions contributed much more to the increase in the construction phase than other sources for buildings. Love *et al.* (2008) stated that client and design consultant changes which cause rework, have consequently been identified as primary factors contributing to time and cost overruns on construction projects. Oyewobi *et al.* (2016) also argued that quality assurance is the main contributor to the occurrence of rework due to the unnecessary exertion of resources in efforts of redoing an activity that was subject to non-conformance of specification at the first time of asking. This is supported by McDonald (2015) that, quality failures in projects are a result of rework caused by errors, omissions and poor management practices. Palaneeswaran (2006) contends that where a project is identified to consist of rework characteristics related to additional time, additional cost to rectify the occurrence, more materials for rework and wastage and substantial increase in labour cost to fix the defect; the cost of rework is further influenced. These extra costs according to McDonald (2015) are deemed to be both unnecessary and avoidable.

Due to the perpetual disregard of the fundamental causes of rework on a global scale and particularly in the South African construction industry, this study tends to investigate the causes of rework pertaining to design changes, errors and omissions, as well as the impact that rework has in terms of overall project performance.

1.1 The research problem and questions

Rework has a direct correlation to project performance as it is a common occurrence in construction projects and has been identified as one of the factors that can degrade project performance (Li & Taylor, 2011). The hindrance of the completion of critical path activities thus results in direct time delays to the overall completion of the project. Due to a formulation of a new scope of activities, the project cost is also affected because of the extra allocation of labour and material for the works to be of specified standard and quality (Chester & Hendrickson, 2005). The Construction Industry Institute's (CII, 2005) research revealed that the direct costs caused by rework amount to approximately 5% of the total construction cost of projects. In a similar study in South Africa, it was established that rework contributed significantly to project cost overrun. The total rework cost as a percentage of the original contract value was discovered to be 5.12% (Simeph, Ndiokubwayo, Love & Thwala, 2015). Based on the evidence from the background and the problems cited in the South African construction industry, the problem to be addressed may be stated as follows:

The sources of rework due to human resources, design, information and documentation, and site operations have not been fully examined in terms of the various project phases. More so, the detrimental effect on project performance has been overlooked.

The specific research questions addressed include:

- To what extent do errors, omissions, and changes in scope of work influence the occurrence of design related rework?
- What are the factors that influence the occurrence of rework during the management of building construction projects?
- To what extent does the occurrence of rework affect project performance in terms of project cost, time, and quality?

2. REVIEW OF THE LITERATURE

2.1 Causes of rework

There are various effects and determinants of rework which have been identified in numerous studies. For instance, McDonald (2015) and Oyewombi *et al.* (2016), collectively give insight to the focus areas of the study which incorporate quality control, design errors, planning and scheduling. Figure 1 shows the fish-bone diagram adopted from Fayek *et al.* (2003) after a pilot study aimed at developing a standard methodology for measuring and classifying construction field rework. The fish-bone consists of five broad areas of rework and four probable causes in each of these areas. The five broad areas include the following: 1) human resource capability, 2) leadership and communication, 3) engineering and reviews, 4) construction planning, and schedule and 5) material and equipment supply (Love & Edwards, 2004). McDonald (2015), Oyewombi *et al.* (2016) and Love and Edwards (2004) all categorically identified the causes and effects of direct and indirect rework resulting in productivity and project performance defects. Whereas the study conducted by Mahamid (2016) sought to identify the main causes of rework as perceived by contractors in the construction industry, Palaneeswaran *et al.* (2005) argued that the root causes of rework in construction projects can result from a selection of influences namely errors, omissions, failures, changes, poor communication and poor coordination.

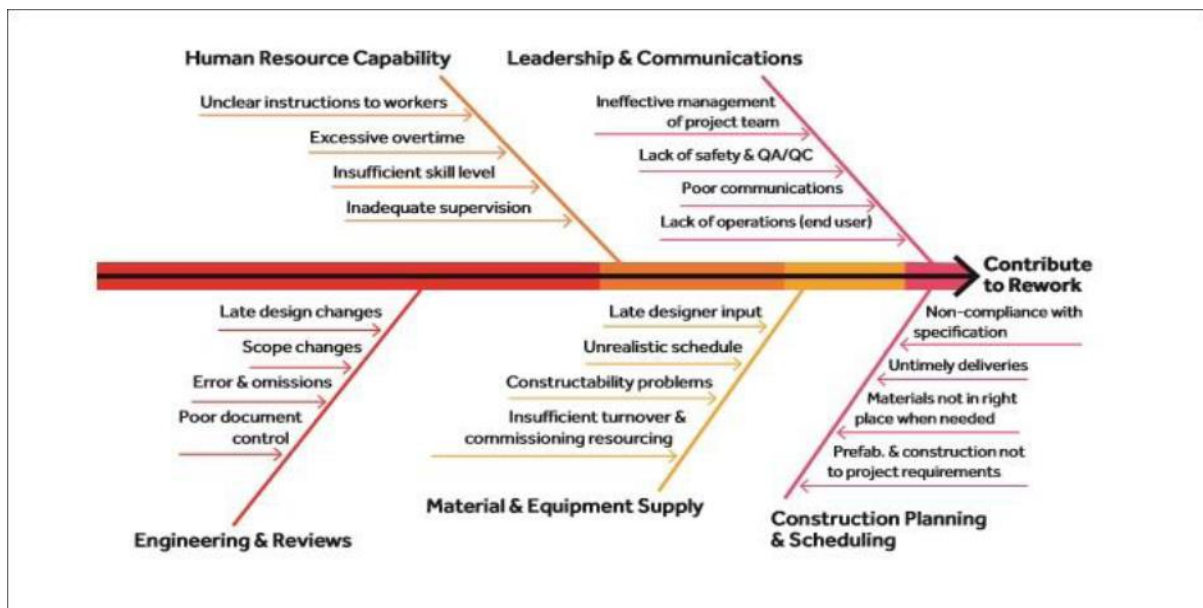

Figure 1: Model of the Root Causes of Rework by Fayek *et al.* (2003)

2.1.1 Errors and omissions

Errors and omissions play a crucial role in influencing the occurrence of rework on construction projects. This was determined and concluded in a study conducted by Hwang *et al.* (2009) using the data obtained from 359 construction projects to identify the root causes of rework in construction projects; where the researchers concluded that client changes and design errors and omissions were the root causes of rework presenting a relatively greater cost impact than other sources. Furthermore, errors and omissions that occur because of negligence by

construction and project managers are some of the most affecting sources of rework (Hwang *et al.*, 2009).

2.1.2 Design changes

The impact of design rework is only a fraction of the total construction rework, which is one of the most associated variables to project performance, and research by Li & Taylor (2011) and Olodapo *et al.* (2007) has illustrated that project managers experience difficulty in an attempt to reduce them (Li & Taylor, 2011). Design-induced rework from errors has been reported to contribute as much as 70% of the total amount of rework experienced in construction projects (McDonald, 2015). In addition, design related rework in the form of change orders is the major source of rework in construction projects, therefore successful mitigation of construction rework is purely dependent on the complexity of the project and the competency of the project team; however, there are strategies that are at the project manager's disposal to substantially improve design quality, assurance and control.

2.1.3 Poor communication and instruction

Cheung *et al.* (2011), Lynch (2012) and Abiola-Falemu (2012) argued that organisational culture could be viewed in the context of commitment, leadership style and management decision-making style. Furthermore, this provides an explanation to the manner used by an organisation as a means of offering multiple supports to its employees, in the form of training and leadership for them to accomplish greater performance and competitive advantage over other organisations (Oyewobi *et al.*, 2016). According to Fayek *et al.* (2003), one of the root causes of rework is inadequate leadership and communication. The authors meticulously accentuate how ineffective communication on construction projects is a contributor to rework. The relationship between management and the labour force is governed by these aspects which are further influenced by sub factors of ineffective management of the project team, inadequate health and safety (H&S), and poor communication (McDonald, 2015). Findings of a study conducted by Mahamid (2006) revealed that poor communication with the contractor presented the highest severity index among other ensuing factors such as, poor communication with the design consultant and lack of client involvement in the project. The results ranked the issue of poor communication with the contractor as the highest with a severity index (SI) of 84%, among eight other factors. Mahamid (2016) concluded that these causes of rework in construction projects could possibly lead to late changes in specifications and scope during the construction phase of the project.

2.2 Effects of rework

The effects of rework are a result of a cause, or a combination of two or more. Rework in construction can negatively influence project schedule (time), cost of the project, quality of work and consequently affect the overall project performance (Oyewobi *et al.*, 2011).

2.2.1 Project performance

Palaneeswaran *et al.* (2005) argued that the direct impact of rework on project performance is recognised to consist of the additional time to perform the rework, the additional cost to remedy the occurrence of the rework, the additional materials for rework and wastage, and a substantial increase in labour cost to correct the defect, including the related allowance for manpower supervision.

2.2.2 Time and cost overruns

Rework is a significant contributor to time and cost overruns which are incurred on construction projects thus will affect the overall project cost, resources and quality (Love, 2004). Rework costs are referenced from the time when the rework is identified to the time when the rework has been remedied according to specification, meaning that the activity has reverted to its original condition (Oyewobi *et al.*, 2011). The resources include the materials, plant and labour which are used on site. As per a study conducted by Oyewombi *et al.* (2011), which sought to determine building elements and their contribution to rework is according to a sample of 25 selected institutional building projects which were part of the study; including the total rework cost of each of the elements. Considering the percentage of rework cost in final cost per each of the elements, fittings and fixtures had the highest percentage of 12.9%. In translation, this means that approximately 13% of the total cost of this element constitutes rework cost. On the other side of the spectrum roof and covering had the lowest percentage contributing to rework cost at 1.17%.

2.2.3 Quality control

The issue of non-conformance has a direct influence on project value and time (McDonald, 2015). Where time is affected and project delays occur, the Construction Project Manager (CPM) is usually obligated to consider the feasible options of declining the quality, extra costs and possible rework. According to McDonald (2015), a reduction in quality will typically result to rework, including additional financial, labour and material resources to adhere to project schedule constraints. According to Wasfy (2010), rework's effect on quality is said to lead to client and contractor dissatisfaction on projects.

3. RESEARCH METHODS

The research method for this study is explained under research measurement instrument, population and sample size, sampling procedure, data collection and analysis techniques. The specific objectives are to: identify the factors influencing the occurrence of rework during construction in South Africa; and determine the impact of rework on project performance in terms of time, cost, and quality as well as on client's and contractors' satisfaction.

3.1 Measurement instrument

The questionnaire was divided into three sections as follows:

(1) General demographics of the respondents;

- (2) Respondents' opinion on the factors influencing the occurrence of rework; and
- (3) Impact of rework on project performance.

For both causes and impact of rework, the respondents were asked to rate the factors they perceived as influencing the occurrence of rework as well as the impact of rework on project performance, on a five-point Likert-scale (1 = minor extent, 2 = a near minor extent, 3 = to some extent, 4 = near to a major extent, and 5 = a major extent)

3.2 Population and sample size

Respondents included architects, quantity surveyors, engineers, project managers, construction managers and other related professionals in the construction industry within the Nelson Mandela Bay Municipality in the Eastern Cape Province. In order to determine a suitable size for the sample, the following formula from Czaja and Blair (1996) and Creative Research Systems (2003) was applied:

$$ss = \frac{z^2 \times p(1-p)}{c^2}$$

Where:

ss = sample size

z = standardised variable

p = percentage picking a choice, expressed as a decimal

c = confidence interval, expressed as a decimal

The sample size was computed as follows: $ss = \frac{1.96^2 \times 0.5(1-0.5)}{0.1^2} = 96.04$

Thus, the required sample size for the questionnaire survey is 96 professionals. However, this figure requires a further correction for finite populations. The formula for this is given in Czaja and Blair (1996) as:

$$\text{New } ss = \frac{ss}{1 + \frac{ss - 1}{pop}}$$

Where:

pop = population

$$\text{New } ss = \frac{96.04}{1 + \frac{96.04 - 1}{320}}$$

$$\text{New } ss = 73.88$$

The sample size is approximately 74 professionals. According to Takim, Akintoye & Kelly (2004) the response rate is believed to range between 20 – 30%. For this reason, it was necessary to adjust the sample size to account for non-response. Assuming a conservative response rate of 30%, the appropriate sample size to be surveyed was calculated as:

$$\text{Survey ss} = \frac{\text{new ss}}{\text{response rate}}$$

Survey ss=74/0.3=247 professionals

3.3 Sampling procedure and data collection techniques

A random selection of construction professionals from the professions and projects register (2016) and contractors in the general building category ranging from grade 3 to 9 who are registered with Construction Industry Development Board (cidb) was thus made to provide a list comprising at least 250 professionals and contractors by generating random numbers in Microsoft Excel 2013. It is worthy to note that out of 247 sent e-mails, 200 were delivered and 47 were not delivered. An internet based survey was used because of the geographical spread of the companies involved in the study (Saunders *et al.*, 2009). Although online surveys often encounter a low response rate (Wiseman, 2003; Archer, 2008), there are many benefits to web-based surveys, these include low cost, broad accessibility of survey design and application instruments, ease of execution including reminders, and builtin characteristics that make data cleaning easy and enhance the survey knowledge for both respondents and researchers (Boyer, Adams & Lucero, 2010; Dillman, Smyth & Christian, 2009; Israel, 2011). Out of the 200 delivered questionnaires, 24 were duly completed and returned, representing a response rate of 12%. Petchenik and Watermolen (2011) report that the response rates from online or web-based surveys are 11% less than postal and phone surveys, and response rates of response as low as 2% have been reported. This is supported by Eysenbach (2005) who indicates that response rates for online surveys are typically much lower than for traditional surveys; for example, questionnaires on websites often have a response rate of less than 1%. Therefore, the response rate in the current study was considered reasonable and within the range given in previous studies.

3.4 Data Analysis technique

The quantitative data was encoded using the Statistical Package for the Social Sciences (SPSS), and results were analysed statistically using the descriptive statistics. The Likert-scale type questions are discussed based on mean score comparisons shown below. The ranges were determined based on the fact that all the Likert-scale type questions used in the research were a five-point Likert-scale. Responses were evaluated based on a five-point Likert scale depicting the degree of influence of which each factor has in relation to rework. The scale ranges from 1 (minor) to 5 (major). The definition of scales relative to the mean scores (MSs) are as follows:

- $1.00 \geq MS \leq 1.80$: between a minor to near minor extent;
- $1.80 < MS \leq 2.60$: between a minor to near minor / near minor extent;
- $2.60 < MS \leq 3.40$: between a near minor extent to some extent / some extent;
- $3.40 < MS \leq 4.20$: between some extent to a near major extent / major extent, and
- $4.20 < MS \leq 5.00$: between a near major extent to a major extent / major extent.

4. PRESENTATION OF FINDINGS

The demographic results of the respondents are depicted in Table 1

Table 1: Demographic results

Criteria	Result
Gender	Out of the 24 respondents, 19 were males (79%) and only 5 were females (21%).
Experience of respondents	The respondents were asked to indicate the amount of time they have been actively involved in the construction industry. The results yielded an average of 13.6 years with most respondents (25%) having between 1 and 5 years of experience in the construction industry and 25% of them had between 10 and 15 years. 21% of them had between 5 and 10 years, 13% between 15 and 20 years and 17% had more than 20 years' experience.
Participant companies and role	The data was obtained from architects, clients, as well as other professionals. Participant firms included contractors (25%), quantity surveyors (25%), architects (8%), design agents (4%), and project managers (8%). Most respondents, 29% were from various fields classified within the 'other' option.

4.1. Causes of rework

The respondents were asked to rate design factors in terms of the extent to which they contribute to rework. The respondents were required to rate these factors on a 5-point scale ranging from 1 (minor) to 5 (major).

The results in Table 2 reveal that out of the 13 design-related factors, client induced changes and late design changes were ranked joint first with mean scores of 3.64. Errors and omissions in the design, and inadequacies in contract documentation were ranked third with mean scores of 3.41. $MSs > 3.40 \leq 4.20$ suggest that client induced changes, late design changes, errors and omissions in the design, and inadequacies in contract documentation can be deemed to have contributed between some extent to a near major extent / major extent to rework. The MSs of inadequate staff to complete the required task, and low fees for design works are $> 2.60 \leq 3.40$, which indicates they contributed between a near minor extent to some extent / some extent to rework.

Table 2: Extent to which design related factors contribute to rework

Factor	Response (%)						MS	Rank
	U	MinorMajor						
		1	2	3	4	5		
Client induced changes	0.0	0.0	9.1	36.4	36.4	18.2	3.64	1=
Late design changes	0.0	0.0	13.6	31.8	31.8	22.7	3.64	1=
Errors and omissions in the design	0.0	4.5	18.2	22.7	40.9	13.6	3.41	3=
Inadequacies in contract documentation	0.0	0.0	22.7	31.8	27.3	18.2	3.41	3=
Design errors	0.0	4.5	18.2	27.3	36.4	13.6	3.36	5=
Variation in scope of work	0.0	0.0	18.2	36.4	36.4	9.1	3.36	5=
Lack of designer's experience	0.0	9.1	22.7	22.7	31.8	13.6	3.18	7
Incomplete design at the time of tender	4.5	9.1	22.7	18.2	27.3	18.2	3.09	8
Insufficient time to prepare contract documentation	0.0	13.6	13.6	36.4	27.3	9.1	3.05	9
Poor planning of workload	0.0	13.6	22.7	40.9	0.0	22.7	2.95	10
Lack of client involvement	0.0	22.7	13.6	31.8	13.6	18.2	2.91	11
Inadequate staff to complete the required task	4.5	13.6	18.2	27.3	31.8	4.5	2.82	13=
Low fees for design works	0.0	13.6	36.4	18.2	18.2	13.6	2.82	13=

Table 3 indicates the extent to which planning and scheduling related factors contributed to rework. Of the 8 factors, ineffective management of the project team was ranked first with a MS of 3.50, and poor communication with the design consultant was ranked second with a mean score of 3.45 ($> 3.40 \leq 4.20$), which indicates they contributed between some extent to a near major extent / major extent to rework. Scope changes, and poor communication with the contractor were ranked joint third with MSs of 3.23. Lack of experience in the construction process achieved a MS of 2.77 ($> 2.60 \leq 3.40$), which indicates it contributed between a near minor extent to some extent / some extent to rework.

Table 3: Extent to which planning and scheduling related factors contribute to rework

Factor	Response (%)						MS	Rank
	U	MinorMajor						
		1	2	3	4	5		
Ineffective management of the project team	0.0	0.0	9.1	40.9	40.9	9.1	3.50	1
Poor communication with the design consultant	0.0	0.0	18.2	27.3	45.5	9.1	3.45	2
Scope changes	4.5	4.5	9.1	40.9	27.3	13.6	3.23	3=
Poor communication with the contractor	0.0	9.1	13.6	31.8	36.4	9.1	3.23	3=
Unclear instructions to workers	0.0	9.1	18.2	31.8	31.8	9.1	3.14	5
Lack of client involvement in the project	0.0	13.6	22.7	22.7	22.7	18.2	3.09	6
Lack of funding allocated for site investigation	0.0	13.6	22.7	22.7	27.3	13.6	3.05	7
Lack of experience in the construction process	0.0	22.7	13.6	36.4	18.2	9.1	2.77	8

Table 4 indicates the extent to which site related factors contribute to rework. Insufficient skill level of workers is ranked first with a MS of 3.64 ($> 3.40 \leq 4.20$), which indicates it contributed

between some extent to a near major extent / major extent to rework. Only three aspects yielded a MS less than three (< 3.00), namely the use of inefficient equipment (2.86), materials not in the right place when needed (2.59), and untimely deliveries (2.77). Materials not in the right place when needed, achieved a $MS > 1.80 \leq 2.60$, which indicates it contributed between a minor to near minor / near minor extent to rework.

Table 4: Extent to which site related factors contribute to rework

Factor	Response (%)						MS	Rank
	U	MinorMajor						
		1	2	3	4	5		
Insufficient skill level of workers	4.5	4.5	4.5	22.7	36.4	27.3	3.64	1
Inadequate job planning	4.5	9.1	4.5	22.7	36.4	22.7	3.45	2=
Ineffective use of quality control system	4.5	4.5	4.5	31.8	36.4	18.2	3.45	2=
Lack of labour skills	4.5	9.1	4.5	27.3	27.3	27.3	3.45	2=
Non-compliance with specification	4.5	13.6	0.0	22.7	31.8	27.3	3.45	2=
Inadequate supervision	4.5	4.5	9.1	31.8	27.3	22.7	3.41	6=
Poor site management	4.5	9.1	4.5	22.7	40.9	18.2	3.41	6=
Improper subcontractor selection	4.5	4.5	0.0	40.9	45.5	4.5	3.32	8
Use of non-conforming material	4.5	9.1	13.6	27.3	27.3	18.2	3.18	9
Prefabrication and installation not to project requirements	4.5	13.6	9.1	18.2	40.9	13.6	3.18	10
Excessive overtime	4.5	18.2	4.5	40.9	9.1	22.7	3.00	11=
Unrealistic schedule	9.1	9.1	9.1	27.3	36.4	9.1	3.00	11=
Use of inefficient equipment	4.5	18.2	4.5	31.8	40.9	0.0	2.86	13
Untimely deliveries	9.1	9.1	18.2	31.8	22.7	9.1	2.77	14
Materials not in the right place when needed	9.1	18.2	18.2	18.2	31.8	4.5	2.59	15

4.2 Impact of rework

Table 5 indicates the extent to which rework impacts on project performance. It is notable that all ten MSs are above the midpoint score of 3.00, which indicates that in general rework impacts on project performance to a major as opposed to a minor extent. Extra costs to remedy the incidence predominates with a mean score of 4.06, followed by cost overruns with a mean score of 3.94 and extension of manpower supervision hours with a mean score of 3.83. MSs $> 3.40 \leq 4.20$ indicate that the impact is between some extent to a near major extent / major extent. Both insufficient turnover and design team's dissatisfaction were ranked joint last with MSs of 3.05 ($> 2.60 \leq 3.40$), which indicates the extent is between a near minor extent to some extent / some extent.

Table 5: Extent to which rework impacts on project performance

Aspect	Response (%)						MS	Rank
	U	MinorMajor						
		1	2	3	4	5		
Extra costs to remedy the incidence	0.0	0.0	0.0	22.2	50.0	27.8	4.06	1
Cost overruns	0.0	0.0	0.0	38.9	27.8	33.3	3.94	2
Extension of manpower supervision hours	0.0	0.0	5.6	22.2	55.6	16.7	3.83	3

Increase in labour costs to repair the defect	0.0	0.0	5.6	33.3	44.4	16.7	3.72	4
Additional materials for the consequent rework and wastage	5.6	0.0	5.6	33.3	33.3	22.2	3.56	5
End-user / client dissatisfaction	5.3	5.3	5.3	15.8	52.6	15.8	3.53	6
Quality degradation	0.0	0.0	5.6	55.6	27.8	11.1	3.44	7
Contractor's dissatisfaction	5.3	5.3	0.0	63.2	5.3	21.1	3.21	8
Insufficient turnover	15.8	0.0	5.3	42.1	15.8	21.1	3.05	10=
Design team's dissatisfaction	5.3	5.3	10.5	42.1	31.6	5.3	3.05	10=

5.0 DISCUSSION OF FINDINGS

5.1 Causes of rework

The literature revealed that the factors influencing the occurrence of rework can be categorised as design related factors, planning and scheduling factors, and site management-related factors. Design related sources that influenced the occurrence of rework include; client induced changes, late design changes, errors and omissions in the design and inadequacies in contract documentation. The descriptive statistics suggest that the contribution is between some extent to a near major extent / major extent given that the MSs are $> 3.40 \leq 4.20$. This result confirms Love *et al.* (2008) contention and it is consistent with that of Hwang *et al.* (2009) who assert that client and design consultant changes, design errors and omissions contribute much more to the increase in the construction phase than other sources for buildings, and have consequently been identified as primary factors contributing to time and cost overruns on construction projects. Love, Davis, Ellis and Cheung (2010) identified inadequacies in contract documentation as one of the factors that contribute to rework. According to the authors, inadequate contract documentation can be influenced by lack of professionalism by design professionals, due to reduced design fees and may in the long run emerge as a dispute and consequently tarnish the image of participants.

The most significant sources of rework with respect to planning and scheduling include: ineffective management of the project team, poor communication with the design consultant, scope changes and poor communication with the contractor. The descriptive statistics indicate that ineffective management of the project team and poor communication with the design consultant can be deemed to contribute between some extent to a near major extent / major extent since their mean scores are $> 3.40 \leq 4.20$. These findings are akin to the studies of Hwang, Thomas, Haas and Caldas (2009) and Love and Li (2000) who established that ineffective management of the project team and poor communication are as result of poor leadership and poor coordination. Fayek *et al.* (2003) also identified the following probable causes pertaining to leadership and communication: ineffective management of project team; poor communication, and lack of operation persons' buy-in. For instance, Hwang *et al.* (2009) maintained that poor leadership and communication and ineffective decision-making cause rework. In a similar vein, Love, Edward, Irani and Walker (2009) stated that the underlying contributors of rework due to poor leadership; in other words known as ineffective management of the project team are strategic decisions taken by top management or key decision-makers who stimulate the conditions for the adoption of inappropriate structures, processes, practices and technologies for projects. Love and Li (2000) contributed to this debate by highlighting that poor coordination and integration between design team members hindered the flow of information among them. Scope changes and poor communication with the contractor were

ranked joint third with mean scores of 3.23, implying that they contributed between a near minor extent to some extent / some extent. Mastenbroek (2010) shares the same sentiment that scope changes and change in construction methods can lead to rework on site as well as numerous indirect consequences such as stress. Simpeh, Ndiokubwayor and Love (2011) affirm that rework and wastages arises from various sources and one such example is scope changes. Burati, Farrington and Ledbetter (1992) stated that changes can influence the aesthetics and functional aspects of the building, the scope as well as the nature of work, or its operational aspects.

Factors linked with site management include insufficient skill level of workers, inadequate job planning, ineffective use of quality control system, lack of labour skills, non-compliance with specification, inadequate supervision and poor site management. The MSs indicate that they contributed between some extent to a near major extent / major extent to rework, since the MSs are $> 3.40 \leq 4.20$. These findings are supported by Hwang *et al.* (2009) who identified inadequate pre-project planning as a contributing factor to rework. For instance, changes due to improper planning contribute significantly to rework cost as opined by Josephson, Larsson and Li (2002), costs which could be as high as 34%, wrong information (15%), and bad planning method (15%). Fayek *et al.* (2003) also identified lack of safety and quality assurance and control commitment as a major source of rework.

5.2 Impact of rework

The MSs indicate that extra costs to remedy the incidence, cost overruns, extension of supervision hours, increase in labour costs to repair the defects, contributed to poor project performance because of rework. Furthermore, additional materials for the consequent rework and wastage, end-user / client dissatisfaction, quality degradation, contractor's dissatisfaction, insufficient turnover and design team's dissatisfaction because of rework impacted on project performance. The descriptive statistics reveal that all the factors have MSs above the midpoint of 3.00, which indicates that in general which indicates that in general rework impacts on project performance to a major as opposed to a minor extent. These findings imply that the occurrence of rework clearly has an adverse impact on project performance. This view is supported by Oyewobi *et al.* (2011), Palaneeswaran *et al.* (2005), Love *et al.* (2008), and Wasfy (2010), who revealed that rework does in fact have a negative impact on project performance in terms of cost overrun, time overrun, quality, and dissatisfaction of the relevant project stakeholders. Palaneeswaran (2006) maintained that rework has both direct and indirect impact on project performance. For instance, Love (2002) identified reduced profit, diminished professional image, inter-organisational conflict, loss of future work, and poor morale, as indirect effects of rework. At the project level, work inactivity such as waiting time, idle time, travelling time and end-user dissatisfaction were identified as indirect consequences of rework.

6. CONCLUSIONS

To date there has been limited research that sought to determine the factors influencing the occurrence of rework and its consequences on project performance in the South African context. While the study presented in this paper has been exploratory in nature, it has demonstrated that the factors influencing the occurrence of rework are significant. The findings revealed that client induced changes, late design changes, poor communication, and insufficient skill levels of construction workers, non-compliance with specification were the major factors influencing

the occurrence of rework during construction. The results of the study also revealed that cost overruns, extension of manpower supervision and quality degradation impacted on project performance because of rework.

The research has established that many factors contribute to rework during construction, but the magnitude and frequency thereof can be minimised or prevented to enhance project delivery. Effective rework control and management will thus limit the factors which cause rework on construction projects and subsequently create an opportunity for timeous project delivery and end-user satisfaction.

7. RECOMMENDATIONS

Incorporating all stakeholders in decision-making, particularly with regards to critical path works, would reduce the effects of rework on project performance.

Improving management-worker communication mediums (whether written or verbal), would essentially improve the coordination of work, thereby diminishing any chances of errors.

The study has achieved part of its aim and objectives. Further research however can provide insight to the development of an effective reduction strategy of construction rework as well as measures to improve client's and contractor's satisfaction.

The empirical research is limited to data gathered within Eastern Cape (EC) region, besides, only commercial, residential, and industrialised buildings were examined therefore, the result cannot be generalised. Further research on other building projects, and in other provinces is recommended to establish if similar findings would emerge.

8. REFERENCES

- Archer, T. M. (2008). Response rates to expect from Web-based surveys and what to do about it. *Journal of Extension* [Online], 46(3) Article 3RIB3. Available from: www.joe.org/joe/2008june/rb3.php.
- Boyer, C. N., Adams, D. C., & Lucero, J. (2010). Rural coverage bias in online surveys: Evidence from Oklahoma water managers. *Journal of Extension* [Online], 48(3) Article 3TOT5. Available from: www.joe.org/joe/2010june/tt5.php
- Burati, J. L., Farrington, J. J., and Ledbetter, W. B. (1992). Causes of quality deviations in design and construction. *Journal of Construction Engineering and Management*, 118 (1), pp. 34–49.
- Chester, M. & Hendrickson, C. (2005). Cost impacts, scheduling impacts, and the claims process during construction. *Journal of Construction Engineering and Management*, 131(1), pp. 102-107.
- Cidb, (2015). Labour and work conditions in the South African construction industry; Status and Recommendations, Pretoria: cidb.
- Creative Research Systems, (2003). The survey system, <http://www.surveysystem.com/sscalc.htm> (accessed October 21, 2016)
- Czaja, R. & Blair, J. (1996). *Designing surveys: a guide to decisions and procedures*, Thousand Oaks, California; London, Pine Forge Press.
- Dillman, D. A., Smyth, J. D., & Christian, L. M. (2009). *Mail and Internet Surveys: The Tailored Design Method*, (3rd ed.). New York: John Wiley and Sons.
- Eysenbach, G. (2005). Using the Internet for Survey and Research, in Anderson, J.G. and Aydin, C.E. (eds.) *Evaluating the Organizational Impact of Healthcare Systems*, New York: Springer Science + Business Media, Inc.
- Fayek, A. R., Dissanayake, M., and Campero, O. (2003). Measuring and classifying construction field rework: A pilot study. Research Rep. (May), Construction Owners Association of Alberta (COAA), The University of Alberta, Edmonton, Canada.

- Han, S., Lee, S. & Pena-Mora, M. G. (2007). Modeling and representation of non-value adding activities due to the errors and changes in design and construction projects. *Proceedings of the 2007 Winter Simulation Conference*, pp. 2082-2089.
- Hwang, B.-G., Thomas, S. R., Haas, C. T. & Caldas, C. H., (2009). Measuring the Impact of Rework on Construction Cost Performance. *Journal of Construction Engineering and Management*, 135(3), pp. 187-198.
- Israel, G. D. (2011). Strategies for obtaining survey responses for Extension clients: Exploring the role of e-mail requests. *Journal of Extension* [Online], 49(3) Article 3FEA7. Available from: <http://www.joe.org/joe/2011june/a7.php>
- Josephson, P. E., Larsson, B. and Li, H. (2002). Illustrative benchmarking rework and rework costs in Swedish construction industry, *ASCE Journal of Management in Engineering*, 18 (2), pp. 76-83.
- Li, Y. & Taylor, T. R. (2011). The Impact of Design Rework on Construction Project. *Journal of Construction Management*, 1(1), pp. 1-15.
- Love, P.E.D., Davis, P.R., Ellis, J. M. and Cheung, S. O. (2010). Dispute causation: Identification of Pathogenic Influences. *Engineering, Construction and Architectural Management*, 17 (4), pp. 404-423.
- Love, P.E.D., Edwards, D. J., Irani, Z. and Walker, D.H.T. (2009). Project pathogens: The anatomy of omission errors in construction and engineering projects, *IEEE Transactions on Engineering Management*, 56 (3), pp. 425-435
- Love, P. E. D. & Edwards, D. J. (2004). Determinants of rework in building construction projects. *Engineering, Construction and Architectural Management*, 11(4), pp. 259-274.
- Love, P. E. D., Edwards, D. J. and Irani, Z. (2004). A rework reduction model for construction, *IEEE Transport Engineering Management*, 51 (4), pp. 426-440.
- Love, P. E. D. (2002). Auditing the indirect consequences of rework in construction: a case based approach, *Managerial Auditing Journal*, 17 (3), pp. 138-146.
- Love, P. E. D. and Li, H. (2000). Quantifying the causes and costs of rework in construction, *Construction Management and Economics*, 18 (4), pp. 479-490.
- Mahamid, I. (2016). Analysis of Rework in Residential Building Projects in Palestine. *Jordan Journal of Civil Engineering*, 10(2), pp. 197-208.
- Mastenbroek Y.C. (2010). Reducing rework costs in construction projects, Published Bachelor's degree Thesis, University of Twente.
- McDonald, R. (2015). *Root Causes & Consequential Cost of Rework*, New York: North America Construction.
- Oyewobi, L. O., Abiola-Falemu, O. J. & Ibiroko, O. T. (2016). The impact of rework and organisational culture on project delivery. *Journal of Engineering Design and Technology*, 14(2), pp. 1-30.
- Oyewobi, L. O. et al., (2011). The effect of project types on the occurrence of rework in expanding economy. *Journal of Civil Engineering and Construction Technology*, 2(6), pp. 119-124.
- Palaneeswaran, E. (2006). Reducing Rework to Enhance Project performance Levels. Hong Kong, Department of Civil Engineering, the University of Hong Kong, pp. 5.1-5.10.
- Petchenik, J., & Watermolen, D. J. (2011). A cautionary note on using the Internet to survey recent hunter education graduates. *Human Dimensions of Wildlife* 16(3), pp. 216-218.
- Saunders, M., Lewis, P., & Thornhill, A. (2009). *Research Methods for Business Students*, 5th Ed. Hallow: Prentice Hall.
- Simeh, E. K., Ndiokubwayo, R., Love, P.E.D., & Thwala, W.D. (2015). A rework probability model: a quantitative assessment of rework occurrence in construction projects, *International Journal of Construction Management*, 15(2), pp. 109-116
- Simeh, E.K., Ndiokubwayo, R. and Love, P.E.D. (2011) Field diagnosis of causes and effects of rework in higher education residential facilities, *Journal of Construction*, 4(1), pp. 17-24
- Statistics South Africa (2015). *Gross Domestic Product: Fourth quarter 2015*, Pretoria: Stats SA.
- Takim, R., Akintoye, A. & Kelly, J. (2004). Analysis of Performance Measurement in the Malaysian Construction Industry, In Ogunlana, S. O., Chareonngam, C., Herabet, P. & Hadikusumo, B. H. W. (Eds.) *Globalization and Construction*, AIT Conference Centre, Bangkok, Thailand, 533-546.
- Wiseman, F. (2003). On the reporting of response rates in Extension research. *Journal of Extension* [Online], 41(3) Article 3COM1. Available at: <http://www.joe.org/joe/2003june/comm1.php>

AN ANALYTIC NETWORK PROCESS MODEL TO ASSESS THE INTERNATIONAL COMPETITIVENESS OF CONTRACTING FIRMS

B. Ozorhon, C. Kus and S. Caglayan

Department of Civil Engineering, Bogazici University, Bebek, 34342, Istanbul, Turkey

Email: beliz.ozorhon@boun.edu.tr, cansu.kus@boun.edu.tr, semih.caglayan@boun.edu.tr

Abstract: Contracting firms need to assess their competitive position in order to sustain their existence under fierce competition and an increasingly globalized business environment. Besides the models developed at the industry level, many scholars have tried to investigate the competitiveness factors that affect construction firms. Despite the high number of studies investigating competitiveness at different levels, there is no model analysing the competitiveness of a contractor in the international markets by considering the interrelations among the determinants of competitiveness. This study aims to develop a framework to assess competitiveness of international contracting firms. In this context, competitiveness factors have been identified based on an extensive literature review. The initial list of variables included 76 competitiveness factors, which were then rearranged and refined into 47 factors. These factors were grouped under nine categories including effectiveness of strategies, managerial capabilities, organizational capabilities, efficiency of technical resources, efficiency of human resources, efficiency of financial resources, effectiveness of relationships, favourability of host country conditions, and favourability of market conditions. An Analytic Network Process (ANP) model was proposed to analyse the interrelations among the model parameters and to compute their importance weights. After the model was constructed, pairwise comparison matrices were formed based on the interdependencies between the factors. The pairwise comparisons are made using a nine-point scale. The experts were asked to evaluate these matrices, which were later used to compute the importance weights of the attributes. Analysis results suggest that “effectiveness of strategies” is the most influential cluster that contributes to the competitiveness of the contractors, followed by “organizational capabilities” and “managerial capabilities”, respectively. The findings of this study are expected to guide contractors in developing appropriate strategies to pursue in international markets and selecting right projects to bid for.

Keywords: Analytic Network Process, Competitiveness, Contracting Firms, International Construction.

1. INTRODUCTION

According to World Competitiveness Yearbook (IMD, 2013), competitiveness is “a field of economic knowledge, which analyses the facts and policies that shape the ability of a nation to create and maintain an environment that sustains more value creation for its enterprises and more prosperity for its people”. Competitiveness is an important research topic in construction business as well. There are many frameworks to analyse the competitiveness at the industry level including the Diamond Model (Porter, 1990), the Three Dimensions Model (Feurer and Chaharbaghi, 1994), the Double Diamond Model (Moon et al., 1995), the Nine-factor Model (Cho, 1994), Assets-Processes-Performance (APP) Model (Buckley et al., 1988), the Competitiveness Triange (Lall, 2001), and Total Value Competitiveness (Shen et al., 2003). Ofori (1993) used the Diamond framework to formulate a long-term strategy for Singapore’s construction industry. Momaya and Selby (1998) conducted a comparison of the competitiveness of the Canadian construction industry in relation to that of the USA and Japan by adopting the APP model. Oz (2000) applied the Diamond model to the Turkish construction industry. Shen et al. (2003) applied Total Value Competitiveness Framework to Chinese construction industry. Mutti (2004) adapted the Double Diamond for assessing the

competitiveness of Brazilian contractors in the international market. Deng et al. (2012) adopted Porter's Diamond Model to develop potential factors formulating the competitiveness of the construction industry, and uncovered the factors that formulate the competitiveness of the Chinese construction industry.

Contracting firms need to assess their competitive position in order to sustain their existence in an increasingly globalized and competitive environment. Besides the models developed at the industry level, many scholars tried to investigate the competitiveness factors that affect construction firms. For example, Hatush and Skitmore (1997) constructed five major attributes for assessing a contractor's competitiveness during the pre-qualification and bidding process, including financial soundness, technical ability, management capability, health and safety and reputation. Drew and Skitmore (2001) measured a contractor's competitiveness among bids according to the type and size of construction work and the type of client involved. Lai and Guan (2001) developed a model to assess a large contractor's competitiveness by using the parameters of organizational ability, marketing ability, technical ability, financial ability, and image ability. Shen et al. (2004) investigated the characteristics of construction business environment in China and identified the key parameters used in assessing contractors' competitiveness for awarding construction contracts in the market. El-Diraby et al. (2006) used analytic hierarchy process (AHP) to provide an understanding of how construction companies evaluate market attractiveness and company competitiveness. Ozorhon et al. (2006) used case-based reasoning to predict the level of competitiveness of a company based on a number of project, market, and host country related factors. Lu et al. (2008) identified critical success factors (CSFs) for determining the competitiveness of a contractor in China. Beelaerts et al. (2010) emphasized the importance of lean supply chain management. Sha et al. (2008) developed a competitiveness index to evaluate the industrial competitiveness of ten provinces in China. Orozco et al. (2011) presented a study to determine the critical variables that define the competitiveness of Chilean general contractors. Bai et al. (2011) proposed an AHP model to analyse essential competitiveness factors for international contractors.

Despite the high number of studies investigating competitiveness at different levels, there is no model analysing the competitiveness of a contractor in the international markets by considering the interrelations among the determinants of competitiveness. Given this background, the major objective of this paper is to propose an analytic network process (ANP) based competitiveness model for international contracting firms. The model explores the links among various parameters and thereby enables the computation of importance weight of each parameter.

2. COMPETITIVENESS MODEL FOR CONTRACTING FIRMS

There are two main theories of firm competitiveness: competitive advantage and resource-based view (RBV). According to Porter (1980), competitive advantage stems from the competitive strategy adopted to deal with the external forces such as opportunities and threats facing an organization (Lu et al., 2008). Based on this view, the competitive advantage originates from external sources rather than internal (firm-specific) sources. Porter (1985) later introduced the value chain analysis to define primary and supportive activities within a firm and proposed that the performance of those activities create competitive advantage. The second theory of firm level competitiveness that looks into the resources and capabilities/competencies of the firms is asserted by strategic management scholars. Lu et al. (2008) stated that this theory suggests the determinants of competitive advantage as firm-specific resources, which are valuable, rare, non-substitutable, and inimitable (Wernerfelt, 1984; Barney, 1991; Hamel and

Prahalad, 1994). Proponents shift the focus from the external to internal sources of competitive advantage, by claiming that a firm creates a competitive advantage through the accumulation, development, and use of its unique resources, capabilities, and knowledge.

This study aims to develop a framework that can assess contracting firms' competitiveness. For this purpose, firstly, competitiveness parameters affecting construction contractors were identified through an extensive literature review. Competitiveness is defined as the ability of the firms to win contracts in international markets. The initial list of variables included 76 competitiveness factors, which were then rearranged and refined into 47 factors. The final list was discussed with industry practitioners as well. Competitiveness factors for contracting firms are combined in 9 groups, namely "effectiveness of strategies", "managerial capabilities", "organizational capabilities", "efficiency of technical resources", "efficiency of human resources", "efficiency of financial resources", "effectiveness of relationships", "favourability of host country conditions", and "favourability of market conditions". Grouping of the variables is based on both the external and internal factors that have impact on competitiveness. It is proposed that competitiveness depend on both company resources and capabilities, and environmental conditions along with how well these factors are exploited through strategies. In this respect, it adopts a synthesis of Porter's (1980; 1985) work and RBV. Competitiveness factors used in this study are shown in Figure 1.

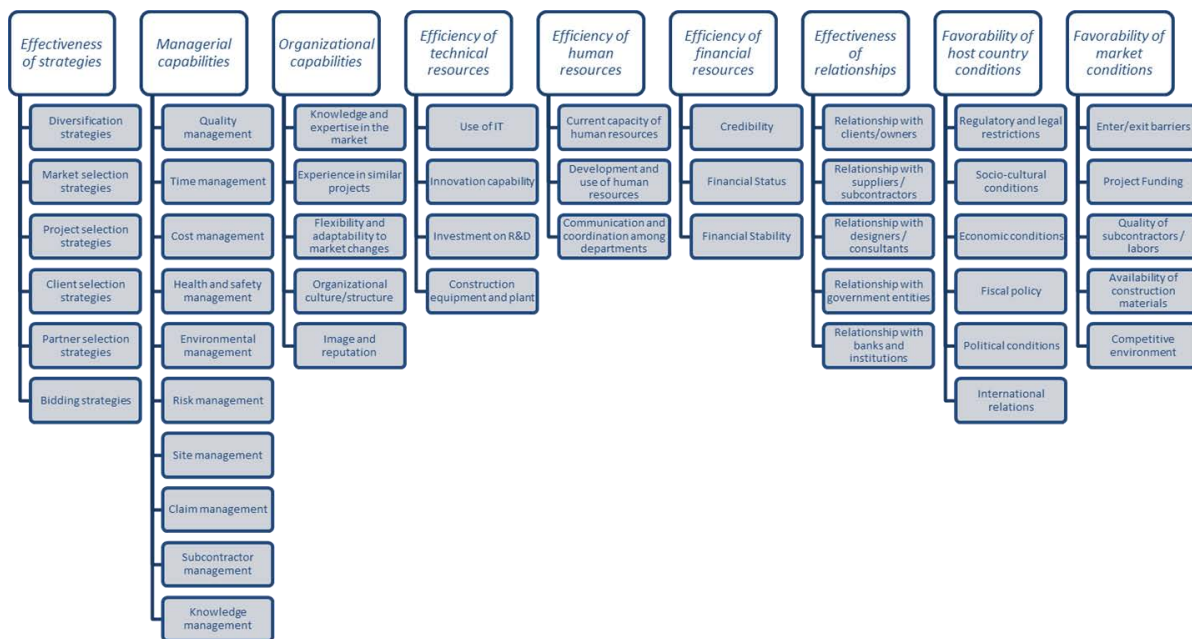

Figure 1: Competitiveness factors

The next step was to establish and analyse the interrelations among those factors, for which an ANP model was developed. The ANP is the most comprehensive framework that allows one to include all the factors and criteria, tangible and intangible (Saaty, 1996). It is an appropriate method to use when the performance assessment model contains a number of interrelated performance criteria, most of which are qualitative rather than quantitative (Ozorhon et al., 2007). ANP model consists of the control hierarchies, clusters, elements, interrelationship between elements, and interrelationship between clusters and it is a generic form of AHP (Saaty, 1996). AHP is known as a powerful and flexible multi criteria decision-making method to assist decision makers when both qualitative and quantitative aspects of a decision are considered. The major principle of AHP is the comparison of elements in a decision hierarchy with respect to the controlling criterion at the next higher hierarchical level. However, AHP

does not allow interdependencies between the components of a problem. The ANP, on the other hand, can accommodate interactions among the model parameters and therefore it is selected as the most appropriate tool for this research.

In the construction sector, ANP has been used by many researchers as the analysing tool for complicated multivariate decision making problems. Niemira and Saaty (2004) made use of ANP in their study of forecasting financial crisis. Dagdeviren et al. (2005) formed a model to identify total work load level of employees by ANP. Chen and Wong (2005) utilized ANP in developing a model for environmentally conscious construction planning. Ozorhon et al. (2007) developed an ANP model to examine the links between the determinants of performance and observed the influences of these factors on the international construction joint venture performance. Polat and Donmez (2009) proposed an ANP model to assist construction companies to select the marketing activities for which they should primarily allocate their limited resources. Dikmen et al. (2010) identified the determinants of business failure in construction and used their ANP model to predict the failure likelihood of construction companies by assessing their current situation based on both company-specific and external factors. Erdem and Ozorhon (2013) developed an ANP model to examine the links between the attributes of success and compute the importance weights of these variables on the real estate project success.

A 47x47 matrix was used to determine the links between competitiveness factors. Brainstorming sessions were conducted with a team of experts to discuss the interrelations between the model parameters. Then the results were validated with previous work in the literature. Respondents were chosen among experienced civil engineers, who are senior level managers. Their average experience in construction sector is 19 years. The average company age is 47.6, all companies are members of the Turkish Contractors Association (TCA) and ranked among the world's Top 225 International Contractors, according to the Engineering News-Record (ENR). The average company age is 47.6. Ten experts participated in the data collection. Although there is no minimum number for the panel size, it is common to conduct the ANP exercise with the participation of three or more experts (Dikmen et al., 2010). Table 1 provides brief information about the respondents, who attended the brainstorming sessions. It should be noted that all experts are chosen from different companies to obtain as diverse opinions as possible.

Table 1: Information about the respondents

No	Company's Age (Year)	Respondent's Experience (Year)	Respondent's Position
1	60	18	Deputy General Manager
2	50	15	Tendering and Project Development Coordinator
3	65	20	Business Development and Tendering Coordinator
4	21	12	Business Development Manager
5	20	30	Executive Committee Member
6	38	14	Business Development Manager
7	76	10	Business Development Manager
8	11	20	Business Development and Tendering Coordinator
9	67	20	Business Development Manager
10	68	35	Deputy General Manager

The network of interrelations was finalized based on both a synthesis of experts' opinions and literature survey. Categorization of the identified competitiveness factors leads to a two-level hierarchy, where the top level elements (clusters) are decomposed into lower level factors (node). The top level criterion, which is competitiveness, is composed of 9 clusters as mentioned above. Figure 2 depicts the interrelations among the clusters of the model.

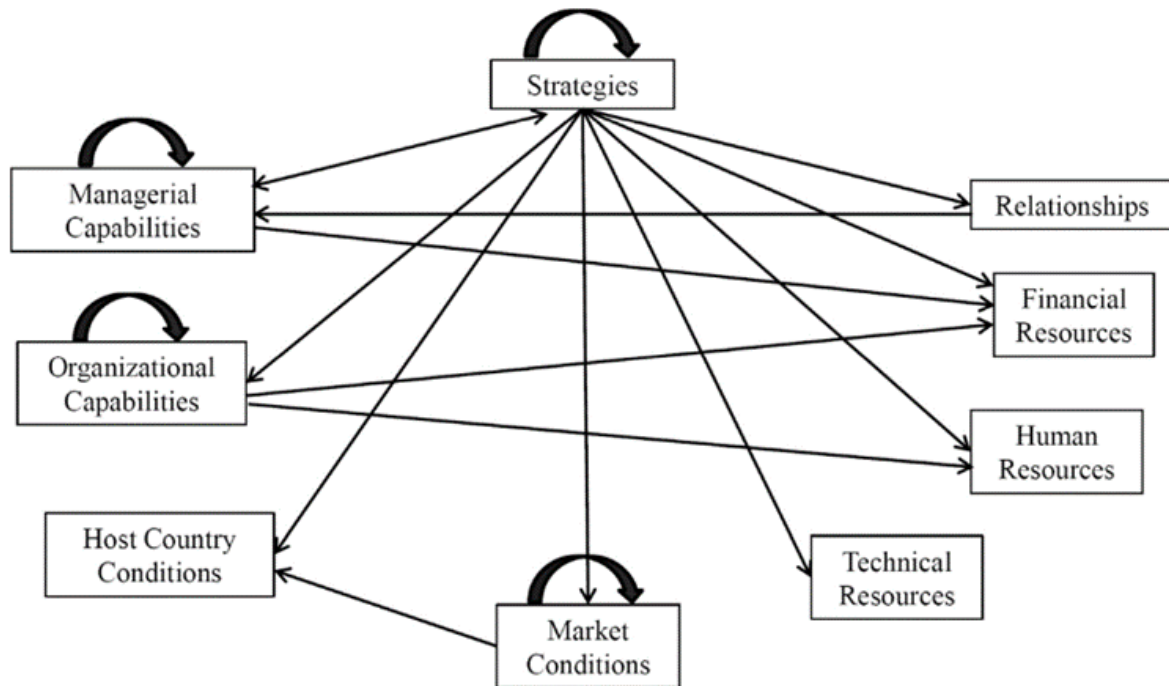

Figure 2: Interrelations among the clusters

Based on the model, the internal and external factors of competitiveness determine the level of “effectiveness of strategies”. Strategies and financial resources affect the “managerial capabilities”, whereas “organizational capabilities” depend on human resources and financial resources. “Market conditions” are affected by host country conditions. Besides the interrelations between these clusters, there are inner dependencies as well. Nodes within “strategies”, “managerial capabilities”, “organizational capabilities”, and “market conditions” interact with each other.

After the model was constructed, pairwise comparison matrices were formed based on the interdependencies between the nodes. The pairwise comparisons are made using a nine-point scale. The experts were asked to evaluate these matrices, which were later used to compute the importance weights of the attributes. To illustrate, some examples of comparison matrices are given in Table 2, 3, and 4. Table 2 shows the inter-dependencies between clusters with respect to the main goal, which is competitiveness level.

Table 2: Inter-dependencies between clusters with respect to competitiveness level

Competitiveness Level (Goal)	A	B	C	D	E	F	G	H	I
Effectiveness of strategies (A)		2	3	5	6	4	3	4	3
Managerial capabilities (B)	1/2		1/2	3	4	2	2	3	2
Organizational capabilities (C)	1/3	2		3	4	2	3	3	2
Efficiency of technical resources (D)	1/5	1/3	1/3		1/2	1/3	1/2	1/2	1/2
Efficiency of human resources (E)	1/6	1/4	1/4	2		1/4	1/4	1/3	1/4
Efficiency of financial resources (F)	1/4	1/2	1/2	3	4		3	3	2

Effectiveness of relationships (G)	1/3	1/2	1/3	2	4	1/3		4	3
Favourability of host country conditions (H)	1/4	1/3	1/3	2	3	1/3	1/4		3
Favourability of market conditions (I)	1/3	1/2	1/2	2	4	2	1/3	1/3	

Inter-dependencies between nodes with respect to effectiveness of strategies are shown in Table 3.

Table 3: Inter-dependencies between nodes with respect to effectiveness of strategies

Effectiveness of strategies (A)	A1	A2	A3	A4	A5	A6
Diversification strategies (A1)		5	1/3	1/4	1/5	1/6
Market selection strategies (A2)	1/5		4	4	2	1/3
Project selection strategies (A3)	3	1/4		1/2	1/2	1/4
Client selection strategies (A4)	4	1/4	2		1/2	1/4
Partner selection strategies (A5)	5	1/2	2	2		1/3
Bidding strategies (A6)	6	3	4	4	3	

It is also possible that a node from one category may depend on nodes from another category. Table 4 shows the inter-dependencies between nodes with respect to market selection strategies.

Table 4: Inter-dependencies between nodes with respect to market selection strategies

Market selection strategies (A2)	I1	I3	I4	I5
Enter/exit barriers (I1)		3	3	1
Quality of subcontractors/labour (I3)	1/3		1	1/2
Availability of construction materials (I4)	1/3	1		1/2
Competitive environment (I5)	1	2	2	

Pairwise comparisons between parameters were performed based on brainstorming sessions of the expert team. This collaborative approach was used to achieve a more reliable model through consensus among the experts. The consistency of judgment needs to be also computed, as it can be a problem during the ANP exercise. In this step, a software package called “Super Decisions” is used to calculate the consistency ratio values (as an indicator of inconsistency of the evaluations). Saaty (1994) set three acceptable levels for consistency: 0.05 for a 3 by 3 matrix, 0.08 for a 4 by 4 matrix, and 0.10 for other matrices. Consistency ratios for all matrices were found to be less than the recommended level of 0.10 as set by Saaty (1994).

Pairwise comparison matrices are combined by the program to form a synthesized matrix called the “supermatrix” that is constructed for the analysis of relationships between the nodes and clusters of the ANP model. A supermatrix is computed in three-step calculation; the unweighted supermatrix is formed based on scorings of pairwise comparison matrices among interacting elements as the first step, then the program calculates the weighted supermatrix by multiplying the values of the unweighted supermatrix with cluster weights on which nodes connect, and as last step a limiting supermatrix is achieved by raising the weighted supermatrix to powers until all the columns corresponding to any node concentrate on the same values. The values in the limiting supermatrix are equal to the resultant priorities (importance weights) of the parameters. The importance weights of clusters and importance weights of top 10 nodes are given in Table 5 and Table 6, respectively.

Table 5: Importance weights of clusters

Code	Cluster Name	Limiting
A	Effectiveness of strategies	0.26628
B	Managerial capabilities	0.13895
C	Organizational capabilities	0.16743
D	Efficiency of technical resources	0.03697
E	Efficiency of human resources	0.03248
F	Efficiency of financial resources	0.12334
G	Effectiveness of relationships	0.10441
H	Favourability of host country conditions	0.06689
I	Favourability of market conditions	0.06325

Table 6: Importance weights of top 10 nodes

Code	Node	Importance weight
A6	Bidding strategies	0.08991
C2	Experience in similar projects	0.07868
F2	Financial status	0.07578
A2	Market selection strategies	0.04454
C1	Knowledge and expertise in the market	0.04386
A5	Partner selection strategies	0.04349
G1	Relationship with clients/owners	0.03839
A1	Diversification strategies	0.03431
F3	Financial stability	0.03310
A4	Client selection strategies	0.03122

According to the analysis, “effectiveness of strategies” cluster is the most influential group of factors that contribute to the competitiveness level of the contractors. Effective strategies enable construction firms to match their activities to the changing environment and achieve superior performance in competition. Therefore, there is a need for studying contractors’ competitive strategies (Tan et al., 2012). “Effectiveness of strategies” is followed by “organizational capabilities” and “managerial capabilities”, respectively. By considering managerial capabilities such as time, cost, risk, claim, and site management, all relevant factors are rated as critical in affecting a contractor’s competitiveness, except for the environment and health and safety. Managerial capabilities reflect a contractor’s ability to provide clients high quality products or service. Good managerial capabilities help contractors maintain and improve their operational effectiveness and form the competitive advantages in bidding (Raftery et al., 1998). It should be noted that “efficiency of human resources” and “efficiency of technical resources” are found to be the least influencing factors affecting competitiveness. This might be because without proper strategies and skills, resources cannot be mobilized and they do not solely create competitive advantage.

In terms of the nodes, “bidding strategies” is found to be the most influencing competitiveness factor. Similar findings can be found in the literature as well (Lu et al., 2008). Good bidding technique will enable contractors to win more contracts, which in turn helps to sustain a contractor’s competitiveness (Lu et al., 2008). On the other hand, bidding is a process for a contractor to show competence through organizing its resources effectively. Contractors may not win in a bidding process if its resources are not properly organized even though they are very competent (Shen et al., 2004).

“Bidding strategies” is followed by “experience in similar projects”, and “financial status”. Experience in similar projects is traditionally known to be a very important source of competitive advantage, as it provides easy entrance to markets and lowers costs due to tried and proven practices/techniques (Dikmen and Birgonul, 2003). Kangari (1988) stated that lack of experience in the company’s line of work accounts for 18.2% of all failures. Therefore, experience is a critical issue in market entry decision and source of competitive advantage. For big-scale projects, prequalification stage is the first step of contractor selection process. It is used to investigate and assess the capabilities of the contractors to carry out a job if it is awarded to them. Financial status is one of the most important factors in the prequalification stage because financial status of a contractor indicates whether a contractor is suitable to meet obligations required by work. Dikmen and Birgonul (2003) found that experience and financial capability were the major strengths of Turkish contractors. This finding ensures the results found in this study.

According to the results, “market selection strategies” is following the top three factors. A firm requires comprehensive research and analysis on macro and microenvironment of the new market before market selection and then need to build strategies to enter new regions where a firm has not been active before. This finding is similar to what was reported previously by Lu et al. (2008).

“Knowledge and expertise in the market” follows “market selection strategies”. The more knowledge and expertise the companies have in the market, the easier it becomes for the companies to get prepared for the bidding process. This factor was cited in the literature in several studies, i.e. Shen et al. (2004) and Ajitabh and Momaya (2004).

“Partner selection strategies” comes after the mentioned factors. A key aspect of the globalization of construction activity is the increasing tendency for construction firms to cooperate strategically across national borders. Reasons for the formation of multinational consortia and joint ventures are to pool technical expertise, reduce the level of exposure to risk or to get round protectionist barriers (Andrews, 1984). Forming partnership combines the distinctive competencies and the complementary resources of each partner. Although it is advantageous to build a partnership, it is difficult to manage because of its complexity, therefore partner selection is very critical (Ozorhon et al., 2007).

“Relationships with clients/owners” is another crucial factor. In some markets, the clients prefer to do repeat business with the contractors, in such cases if the relationships with the clients are strong, then the companies have better chances of being awarded the contracts. Several studies have mentioned the significance of this factor, i.e., Dikmen and Birgonul (2003), Shen et al. (2003), and Tan et al. (2007).

“Diversification strategies” should also be mentioned. According to Cannon and Hillebrandt (1990), diversification is a major contributor to corporate growth. Firms need to adapt diversification strategies to completely utilize existing resources and capabilities. Although it is difficult and complex to coordinate different and related businesses, diversification has some advantages such as expanding product offerings or expanding into new regions. In addition, diversification creates opportunities to grow after a firm has matured and to reduce cyclical fluctuations in revenues and cash flows.

“Socio-cultural conditions of the host country”, “use of IT”, and “environmental management” are the least influencing factors affecting competitiveness of the contractors. It is interesting to

note that although highly cited in the literature (Pries and Janszen, 1995; Allen and Helms, 2006), the importance weight of “investment on R&D” was found to be very low. According to Pries and Janszen (1995), firms can gain competitive advantage by innovating and competing on the basis of product or process innovation. This finding may be attributed to the fact that contracting firms are reluctant to innovate, since the output of innovation is not always guaranteed (Ozorhon, 2013). Rather, contractors try to create competitive advantage by offering low cost and timely construction.

3. CONCLUSIONS

Competitiveness is not easily understood and measured because the definition is abstract and direct assessment cannot be obtained. In this study, a framework was developed to assess the competitiveness level of construction firms. A comprehensive list of competitiveness factors was identified for this purpose. A total of 47 factors were collected in 9 interrelated groups. An ANP model was used to analyse the influence of these factors on competitiveness. Data collection was based on the expert opinions from the Turkish construction sector. The analysis shows that “effectiveness of strategies” group of factors is the most influential cluster that contributes to competitiveness, followed by “organizational capabilities” and “managerial capabilities”, respectively. Besides, resources of the companies should be converted into capabilities that have the potential to increase competitiveness. Resources solely have limited capacity to create competitive advantage.

The factors presented in this study can be applied to build an orderly process to develop competitive strategy of a contracting firm. First of all, strategies employed by a firm serve as a tool to achieve firm’s goals and sustain its competitive advantage. Hence, building effective strategies is the most important factor in terms of competitiveness. Secondly, firm capabilities show how successfully it converts strategies into actions and directly reflect the results of the strategies adopted. Hence, the results in this study are reasonable in terms of the importance weights of the factors. Thirdly, a firm’s resources such as financial, technical, and human resources can be perceived as valuable assets that need to be mobilized to enhance competitiveness by employing appropriate strategies. Besides, relationships should be carefully managed since they affect a firm’s competitive advantage. Finally, external factors such as country conditions and market conditions should be carefully monitored by contracting firms. Environmental scanning is one of the most important components of strategic analysis; therefore, potential market search should be done to identify the opportunities and threats. A firm becomes successful to the degree to which the internal environment of the firm matches with the external environment. Therefore, a firm should analyse its capabilities and resources before entering into a new market and enhance these if necessary.

This study adopted ANP to develop an effective model to assess competitiveness. However, there are a number of limitations of the study. Firstly, the findings reflect the experiences of the Turkish contractors. A similar model may be developed to incorporate different views and experiences from other countries. As a future study, the model will be validated by the use of real construction projects so that the performance of the proposed model could be assessed.

4. REFERENCES

- Ajitabh, A. and Momaya, K., 2004, *Competitiveness of Firms: Review of Theory, Frameworks and Models*, Singapore Management Review, Vol. 26, No. 1, pp. 45-61.
- Andrews, J., 1984, *Construction Project Management in Joint Ventures in Developing Countries*, Unibeam, Vol. 15, pp. 43-47.
- Bai, S., Qi, B., Liu, Y. and Liu, G., 2011, *Research on the Competitiveness Analysis and Evaluation of International Contractor Based on the AHP Model*, In Management and Service Science (MASS), International Conference IEEE, August, pp. 1-4.
- Barney, J., 1991, *Firm Resources and Sustained Competitive Advantage*, Journal of Management, Vol. 17, No. 1, pp. 99-120.
- Beelaerts, W., Santema, S. C. and Curran, R., 2010, *Lean Supply Chain Management in Aerospace*, Encyclopedia of Aerospace Engineering.
- Buckley, P. J., Pass, C. L. and Prescott, K., 1988, *Measures of International Competitiveness: A Critical Survey*, Journal of Marketing Management, Vol. 4, No. 2, pp.175-200.
- Cannon, J. and Hillebrandt, P. M., 1990, *Diversification in the Management of Construction Firm: Aspects of Theory*, Mcmillan, London.
- Chen Z. and Wong, C. T. C., 2005, *EnvironalPlanning: Analytical Network Process Model for Environmentally Conscious Construction Planning*, Journal of Construction Engineering and Management, Vol. 131, No. 1, pp. 92-101.
- Cho, D. S., 1994, *A Dynamic Approach to International Competitiveness: The Case of Korea*, Asia Pacific Business Review, Vol. 1, No. 1, pp.17-36.
- Dagdeviren M., Eraslan, E. and Kurt, M., 2005, *A Model to Determine Overall Workload Level of Workers and its Applications*, Journal of Engineering and Architecture, Vol. 20, No. 4, pp. 517-525.
- Deng, F., Liu, G. and Jin, Z., 2012, *Factors Formulating the Competitiveness of the Chinese Construction Industry: An Empirical Investigation*, Journal of Management in Engineering, Vol. 29, No. 4, pp. 435-445.
- Dikmen, I. and Birgonul, M. T., 2003, *Strategic Perspective of Turkish Construction Companies*, Journal of Management in Engineering, Vol. 19, No. 1, pp. 33-40.
- Dikmen, I., Birgonul, M. T., Ozorhon, B. and Egilmezer, N., 2010, *Using Analytic Network Process to Assess Business Failure Risks of Construction Firms*, Engineering, Construction and Architectural Management, Vol. 17, No. 4, pp. 369-386.
- Drew, D. S. and Skitmore, R. M., 2001, *The Effect of Contract Type and Contract Size on Competitiveness in Bidding*, Construction Management and Economics, Vol. 15, No. 5, pp. 469-489.
- El-Diraby, T. E., Costa, J. and Singh, S., 2006, *How Do Contractors Evaluate Company Competitiveness and Market Attractiveness? The Case of Toronto Contractors*, Canadian Journal of Civil Engineering, Vol. 33, No. 5, pp. 596-608.
- Erdem, D. and Ozorhon, B., 2013, *Assessing Real Estate Project Success Using the Analytic Network Process*, Journal of Management in Engineering, Vol. 31, No. 4.
- Feurer, R. and Chaharbaghi, K., 1994, *Defining Competitiveness: A Holistic Approach*, Management Decision, Vol. 32, No. 2, pp. 49-58.
- Hamel, G. and Prahalad, C. K., 1994, *Competing for the Future*, Harvard Business Books, Boston.
- Hatush, Z. and Skitmore, M., 1997, *Criteria for Contractor Selection*, Construction Management and Economics, Vol. 15, No. 1, pp. 19-38.
- IMD, 2013, *World Competitiveness Yearbook, 2012*, Lousanne, Switzerland: IMD.
- Kangari, R., 1988, *Business Failure in Construction Industry*, Journal of Construction Engineering and Management, Vol. 114, No. 2, pp. 172-190.
- Lai, X. and Guan, K., 2001, *A Study of a Large-Scale Contractor's International Competitiveness*, Building Science Research of Sichuan, Sichuan Institute of Construction Science, Vol. 27, pp. 73-75.
- Lall, S., 2001, *Competitiveness, Technology and Skills*, Edward Elgar Publishing, Cheltenham, UK.
- Lu, W., Shen, L., Yam, M. C., 2008, *Critical Success Factors for Competitiveness of Contractors: China Study*, Journal of Construction Engineering and Management, Vol. 134, No. 12, pp. 972-982.
- Momaya, K. and Selby, K., 1998, *International Competitiveness of the Canadian Construction Industry: a Comparison with Japan and the United States*, Canadian Journal of Civil Engineering, Vol. 25, No. 4, pp. 640-652.
- Moon, C. H., Rugman, A. M. and Verbeke, A., 1998, *A Generalized Double Diamond Approach to the Global Competitiveness of Korea and Singapore*, International Business Review, Vol. 7, No. 2, pp. 135-150.
- Mutti, C. N., 2004, *The Drivers of Brazilian Contractors' Competitiveness in the International Market*, PhD, University of Reading.
- Niemira, M. P. and Saaty, T. L., 2004, *An Analytical Network process Model for Financial Crisis Forecasting*, International Journal of Forecasting, Vol. 20, pp. 573-587.

- Ofori, G., 1993, *Formulating a Long-term Strategy for Developing the Construction Industry of Singapore*, Construction Management and Economics, Vol. 12, No. 3, pp. 219-231.
- Orozco, F. A., Serpell, A. F., Molenaar, K. R. and Forcael, E., 2011, *Modeling Competitiveness Factors and Indexes for Construction Companies: Findings of Chile*, Journal of Construction Engineering and Management, Vol. 140, No. 4.
- Oz, O., 2000, *Sources of Competitive Advantage of Turkish Construction Companies in International Markets*, Construction Management and Economics, Vol. 19, No. 2, pp. 135-144.
- Ozorhon, B., Dikmen, I. and Birgonul, M. T., 2006, *Case-based reasoning model for international market selection*, Journal of Construction Engineering and Management, Vol. 132, No. 9, pp. 940-948.
- Ozorhon, B., Dikmen, I. and Birgonul, M. T., 2007, *Using Analytic Network Process to Predict the Performance of International Construction Joint Ventures*, Journal of Management in Engineering, Vol. 23, No. 3, pp. 156-163.
- Polat, G. and Donmez, U., 2009, *ANP-Based Marketing Activity Selection Model for Construction Companies*, Engineering, Construction and Architectural Management, Vol. 10, No. 1, pp. 89-111.
- Porter, M. E., 1980, *Competitive Strategy: Techniques for Analyzing Industries and Competitors*, Free Press, New York/Collier Macmillan, London.
- Porter, M. E., 1985, *Competitive advantage: Creating and Sustaining Superior Performance*, Free Press, New York/Collier Macmillan, London.
- Porter, M. E., 1990, *Competitive Advantage of Nations*, The Free Press, New York.
- Raftery, J., Pasadilla, B., Chiang, Y. H., Hui, E. C. M. and Tang, B. S., 1998, *Globalization and Construction Industry Development: Implications of Recent Developments in the Construction Sector in Asia*, Construction Management and Economics, Vol. 16, pp. 729-737.
- Saaty, T. L., 1996, *Decision Making with Dependence and Feedback: The Analytic Network Process*, RWS Publications, Pittsburgh, PA.
- Sha, K., Yang, J. and Song, R., 2008, *Competitiveness Assessment System for China's Construction Industry*, Building Research and Information, Vol. 36, No.1, pp. 97-109.
- Shen, L. Y., Li, Q. M., Drew, D. and Shen, Q. P., 2004, *Awarding Construction Contracts on Multicriteria Basis in China*, Journal of Construction Engineering and Management, Vol. 130, No. 3, pp. 385-393.
- Shen, L. Y., Lu, W., Shen, Q. and Li, H., 2003, *A Computer-Aided Decision Support System for Assessing a Contractor's Competitiveness*, Automation in Construction, Vol. 12, No. 5, pp. 577-587.
- Tan, Y., Shen, L. and Langston, C., 2012, *Competition Environment, Strategy, and Performance in the Hong Kong Construction Industry*, Journal of Construction Engineering and Management, Vol. 138, No. 3, pp. 352-360.
- Tan, Y. T., Shen, L. Y., Yam, M. C. H. and Lo, A. A. C., 2007, *Contractor Key Competitiveness Indicators (KCIs): A Hong Kong Study*, Surveying and Built Environment, Vol. 18, No. 2, pp. 33-46.
- Wernerfelt, B., 1984, *A Resource-based View of the Firm*, Strategic Management Journal, Vol. 5, No. 2, pp. 171-180.

W118: CLIENTS AND USERS IN CONSTRUCTION

COMPARATIVE ANALYSIS OF PUBLIC AND PRIVATE CLIENT VALUES FOR POST DISASTER RECONSTRUCTION SERVICES

S. Aliakbarlou¹, S. Wilkinson¹, S.B. Costello¹, and H. Jang²

¹ *Department of Civil and Environmental Engineering, The University of Auckland, 20 Symonds Street Auckland, 1010, New Zealand*

² *Department of Architecture, Seoul National University of Science and Technology, 232 Gongneung-ro, Nowon-gu, Seoul, 139-743, Republic of Korea*

Email: sali768@aucklanduni.ac.nz

Abstract: There is a common belief that continuous improvement in delivery of contracting services is to be achieved through analysing client values. The current paper aims to help contractors to provide better services to their clients by identifying key values for successful delivery of contracting services in post-disaster reconstruction projects. This study was conducted in two steps based on a review of the literature. The first step was about to identify client values for post-disaster reconstruction situations. In the second step, a comparative analysis was used to understand how the importance levels of the identified values differ between New Zealand public and private clients. A key recurring theme from this study is the recognition of the instrumental values as a key strategic variable to meet New Zealand client expectations in post-disaster situations. The study indicates that New Zealand public and private clients have similar perceptions regarding client values within post-disaster reconstruction services. Partnerships with all parties, efficiency of construction methods and techniques, security, health and safety, and willingness to use local resources are slightly more important for public clients. Also, efficient problem resolution procedures, lower contract price, providing necessary guarantees, accessibility and responsiveness are slightly more important for public clients.

Keywords: Client Values, Contracting Services, Contractors, New Zealand, Post-Disaster Reconstruction.

1. INTRODUCTION

Reconstruction after a disaster event, is viewed as undertaking the business-as-usual construction process of replacing the built environment, but over a very intense timeframe (Norling, 2013). After small-scale disasters, existing business-as-usual methods can be modified and used for reconstruction programs. However, for larger scale disasters, there is a greater imperative to have appropriate systems in place, in advance, to enhance effectiveness of reconstruction services delivery (Rotimi et al., 2009). Following disaster events, clients are required to develop a comprehensive procurement mechanism for reconstruction projects (Zuo, 2010). Contractual mechanisms include the client values within contracting services (Masterman, 2003), and contractors should comply with these values (Yang and Peng, 2008). While all contractual mechanisms used in business-as-usual construction have specific values effective for disaster reconstruction situations, it is the weightings of these values to specific circumstances that are more essential (Wilkinson et al., 2005).

In the construction literature, it has been widely accepted that post-disaster reconstruction is poorly managed and requires improvement (Pelling et al., 2004; Meding et al., 2011; Barakat, 2003; Von Meding, 2008; Zhang et al., 2015). It is not uncommon for reconstruction projects to fail to achieve their objectives (Lyons, 2009; Ika et al., 2012). This is due to the fact that reconstruction activities can be slow, expensive and complex (Koria, 2009). Improving

reconstruction programs needs better systems and methods (Sun and Xu, 2011), and updated management processes (Prieto and Whitaker, 2011; Rapp, 2011).

There is a common belief that continuous improvement in delivery of contracting services is to be achieved through analysing client values and satisfaction. For example, according to Sirkin and Stalk (1990) and Ahmed and Kangari (1995) having knowledge of what clients value, contractors are able to understand the causes of their services' issues, and provide changes to address these issues. However, the subject of understanding client values has not been well developed for post-disaster situations. This is because construction literature is focused on business-as-usual situations and rather than reconstruction situations.

While the New Zealand construction industry is very important for the overall economy of the country (Construction Strategy Group, 2015), it is particularly essential for the country's post-disaster reconstruction programs. The current paper aims to help contractors to provide better value to their clients by identifying key values for successful delivery of contracting services in post-disaster reconstruction projects. This study was conducted in two steps based on a review of the literature. The first step was about identifying client values for post-disaster reconstruction situations. In the second step, a comparative analysis was conducted to investigate how the importance levels of the identified values differ between public and private clients in New Zealand.

2. IDENTIFICATION OF CLIENT VALUES FOR DISASTER RECONSTRUCTION

In value theory, value definition is an issue (Perry, 1914), as value may have different meanings to different individuals such as internal and external construction stakeholders (Kelly et al., 2009). This is due to the subjective and ambiguous nature of value. According to Thomson et al. (2003) values are the principles and standards by which individuals live and by which the decisions of individuals and organisations are formed.

In construction literature, the term construction "refers to a process of delivering value to the client through a temporary production system" and the term client "is a representative for a number of – often conflicting – values, interests and time perspectives" (Bertelsen and Emmitt, 2005). Construction client values can be divided into two types such as process values and product values (Emmitt et al., 2005; Kelly, 2007). In construction value management theories, product value is a well-known discipline. However, process value is not paid the same amount of attention and, hence, "there is need for more focus on process values" (Wandahl and Bejder, 2003). Figure 1, shows the difference in perception of product values and process values from different stakeholder perspectives.

Product values are based on physical and environmental attributes (Emmitt et al., 2005). Process values are about giving the client the best experience over the construction project and includes soft values (such as communication and problem solution skills) and hard values (such within time and budget delivery). While the hard values are key to achieving client satisfaction, the soft values play an essential role in bringing satisfaction to the client (Volker, 2010). Clients perceive construction process values through the service provided by, for example, contractors. Wandahl and Bejder (2003) stated that little effort has been made to understand how process value can be used actively in construction value management.

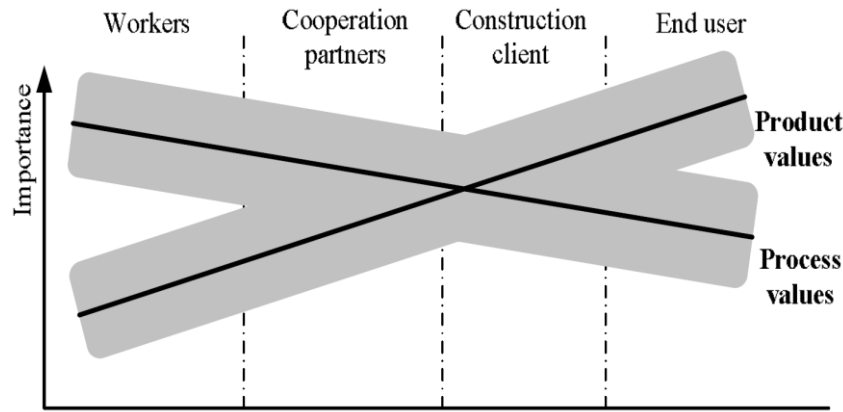

Figure 1: Different perception of values (Wandahl, 2002)

In construction literature, Boyd and Chinyio (2008) categorised values into instrumental and terminal values under the means-ends principle. They determined terminal values by referring to client final goals, while describing instrumental values as means to achieve the terminal values. The terminal values and instrumental values seem to explain the differences between two elements of process values such as hard values and soft values. Client satisfaction can be perceived by achievement of terminal values through instrumental values.

To develop a basis for identifying key client values, some important distinctions must be drawn between the various types of values that need to be considered. The following, using a literature review, highlights what clients value within contracting services in a post-disaster environment.

2.1 Conduct of the review

Continuous improvement of construction services requires concerted effort to deliver client values (Ahmed & Kangari, 1995). Client values should be the key point of reference for project participants throughout the project life cycle (British Standard Institute, 2014). To help achieve this, a comprehensive review of relevant literature on client values was conducted by Aliakbarlou et al. (2017a). Using systematic reviews, 171 (out of 898) research studies were critically analysed. A systematic review can assist in collecting empirical evidence in order to answer a specific research question (Higgins & Green, 2010). Employing such a methodology in construction studies could assist in reviewing the available literature and providing better solutions, particularly in construction management area. This helped in identifying the construction client values by which a service provider can manage the relationships and the service transaction. Further details, including the sample-selection procedure, can be found in Aliakbarlou et al. (2017a).

2.2 Results of the review

Based on a comprehensive literature review, a list of construction client values (140 in total) was developed. The identified values were then classified as either terminal values or instrumental values. The identified values were also validated by conducting interviews with seven expert practitioners from the New Zealand construction industry. The interviews confirmed that all identified values are important to ensure the success of construction services delivery. The list of the client values can be found in Aliakbarlou et al. (2017c).

Despite the availability of various studies that explore client values, they were focused on business-as-usual construction situations and, hence, limited research information exists that could assist participants in the post-disaster reconstruction situation. There are a number of guidelines for post-disaster reconstruction, “but hardly any which are widely endorsed and can be followed by humanitarian agencies” (Ahmed, 2011). Consequently, there is a need to conduct researches to develop critical factors for success in post-disaster reconstruction projects (Coffey & Trigunarsyah, 2012).

3. PRIORITISATION OF TERMINAL AND INSTRUMENTAL CLIENT VALUES FOR DISASTER RECONSTRUCTION

A concerted effort was required to identify the most important and suitable values for post-disaster situations. While client values in business-as-usual construction which be useful for post-disaster reconstruction, it is the weightings of these values to specific circumstances of reconstruction programmes that are lacking. The following, using interviews, highlights client values and their prioritisation within contracting services in a post-disaster environment.

3.1 Conduct of the interviews

After developing the 140 client values through the literature review, interviews with a total of 16 expert reconstruction practitioners in New Zealand were conducted with the aim of exploring client values within contracting services for post-disaster reconstructions (Aliakbarlou et al., 2017c). This is due to the fact that the client values and their prioritisation can be identified based on expert opinion. The significance of the project experts’ experience in relation to project results has been accepted in the literature to assess construction project outcomes (Ibrahim et al., 2014; Chua et al., 1999). “It would be legitimate then to assume that experienced practitioners could compose a set of critical success factors after testing against their experience” (Chua et al., 1999).

In total, 16 established experts, including senior managers and key decision makers from leading reconstruction-related public and private client organisations in New Zealand, participated in the interviews. The sample of participants shows a wide range of experts with significant experience in post-disaster reconstruction projects. The number of participants is dictated by the study characteristics, such as geographic representation and the number of available experts (Hallowell & Gambatese, 2009). Finally, the research sample depends on the participants’ expertise and the collective consensus outcomes, rather than statistical power (Ibrahim et al., 2013a; Okoli & Pawlowski, 2004).

Each interview was started by clarifying the research domain. The list of client values identified from the literature review was provided to the interviewees, who were requested to select the most important values for post-disaster reconstruction, from the list. They were also asked to recommend as many additional suitable and practical candidate values which were not included in the list (Aliakbarlou et al., 2017c). The interviews lasted about 45 to 60 minutes. The interviews were audio recorded and transcribed into written dialogue. Finally, the results were imported into NVivo for further analysis that helped in categorising the identified values.

3.2 Results of the interviews

The interview findings resulted in a substantial list of 39 values. The identified values were then grouped the identified values into terminal and instrumental values. Table 1 shows the terminal and instrumental client values identified from the interviews. Further details of the interviews can be obtained from a study conducted by Aliakbarlou et al. (2017c).

Table 1: Client terminal and instrumental values for post-disaster reconstruction services (Aliakbarlou et al., 2017c)

Category	Client values within contracting services
Terminal	Shorter contract time
	Timeliness
	Delivery speed in construction process & lead-time
	Lower initial contract price
	To budget delivery/appropriate to budget
	Whole life cost/Value for Money
	Higher of standard quality
	Information system adequacy
	Accuracy of decision making and process
	Improved organisational culture
Instrumental	Corporate commitment
	True friendship/partnerships with all parties
	Closer relationship/flexibility in relationship
	Building a trust based relationship
	Long-term business relationship
	Continuous learning & improvement
	Minimised aggravation & litigation
	Efficient problem resolution procedure
	Efficiency of construction methods & techniques
	Appropriate tangibles (site facilities, documentations, claims & reports)
	Competency (planning and implementing reconstruction programmes)
	Understanding client
	Accuracy of variations/invoices & claims
	Potential for innovation & creativity
	Internal teamwork development
	Productivity
	Efficiency of leadership & coordination
	Employee empowerment
	Perceived prosocial behavior
	Communication technique & documentation
	Accessibility & responsiveness
	Security, health & safety
	Environmental protection
	Providing necessary guarantees/assurance
	Financial strength & stability
	Risk management skills & techniques
	Availability of resources (material, labour, & plant)
	Capability of sourcing
Willingness of use of local resources	

The 39 identified values provide a comprehensive set of client values within contractor services and form the basis for developing good client-contractor working relationships in post-disaster reconstruction projects. Reviewing the interview results shows that there is emphasis on instrumental values, such as integration, procurement and communication in post-disaster reconstruction. This is due to the characteristics of post-disaster reconstruction, such as complexity, public pressure, limited resource availability, and unstable economic and chaotic conditions.

4. COMPARISON OF PUBLIC AND PRIVATE CLIENT PERSPECTIVES

Much has been written in the construction literature about the client-contractor relation and how clients perceive value in a contractual relationship. However, it is not clear how the identified values contribute and localise to the context in New Zealand, or challenge existing knowledge in the New Zealand construction industry. Hence, to understand construction client values, the perspective of different types of clients need to be taken into consideration. The following, indicates how the importance levels of values represented in the pervious section differ between public and private clients in New Zealand.

4.1 Conduct of the comparative review

The values identified from the interviews were incorporated into a questionnaire. The purpose of the questionnaire was to quantify the importance of the identified values. The questionnaire survey was then conducted with 59 participants from public and private sector clients. The five-point Likert scale was used to assess the importance of each value (on a scale of 1 to 5 where 1 = least significant, 2 = slightly significant, 3 = significant 4 = very significant, 5 = most significant). The Likert scale is used for rating the relative significance of factors, based on assessing experts' opinions (Chan & Kumaraswamy, 1996; Park, 2009). Further details of the questionnaire survey can be obtained from a study conducted by Aliakbarlou et al. (2017c).

The analyses of importance levels of the values obtained from the questionnaire survey showed a high degree of agreement between public and private client's perspectives. However, in this study, further comparative analysis, using quadrant analysis method, was conducted in order to help post-disaster reconstruction participants to better understand the client values.

The quadrant analysis, as a managerial tool (Sohn et al., 2014; Chapman, 1993; Chéron et al., 1989; Abeka and Ochieng'Abeka, 2012), was employed in this study to graphically compare the identified values. The analysis included two measurements, mean value scores from public clients' perspective and mean value scores from private clients' perspective, which provides four quadrants as shown in Figure 1.

Quadrant 1 includes values whose importance levels are higher than average as perceived by public clients, while their importance levels are lower than average as perceived by private clients. Quadrant 2 includes values whose importance levels are higher than average as perceived by both public and private clients. Quadrant 3 includes values whose importance levels are lower than average as perceived by both public and private clients. Quadrant 4 includes values whose importance levels are higher than average as perceived by private clients, however their importance levels are lower than average as perceived by public clients.

4.2 Results of the comparative review

The result of the comparative review, using the quadrant analysis, illustrated the similarities and differences exist between public and private client's perspective regarding the importance levels of the 39 client values. Figure 2 represents the importance levels of the values shown in Table 1. The values' importance for public clients is represented on the y-axis while the values' importance for private clients is represented on the x-axis. The importance levels of the values are obtained from a study by Aliakbarlou et al. (2017c).

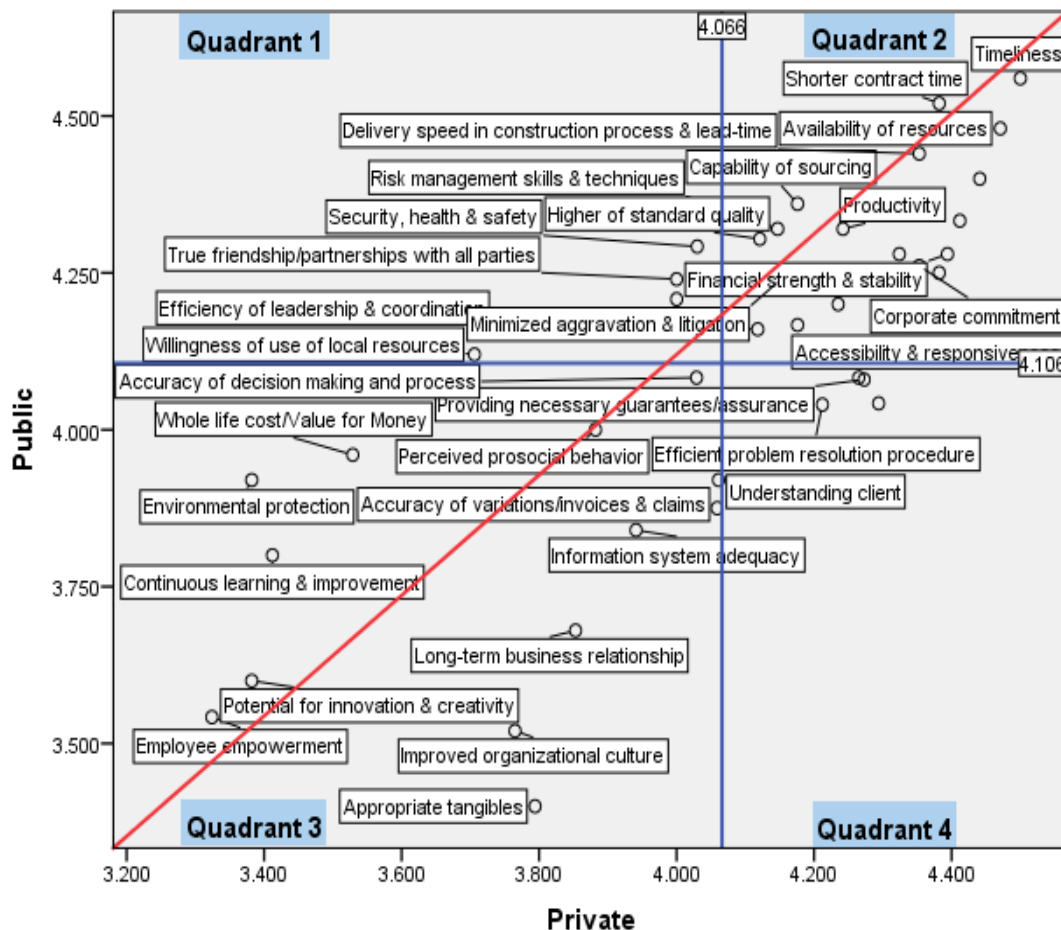

Figure 2: Comparison of public and private client perspective for importance levels of values

The values that fall into Quadrant 1 are true friendship/partnerships with all parties, efficiency of construction methods and techniques, security, health and safety, and willingness to use local resources. Quadrant 2, includes corporate commitment, flexibility in relationship, building trust based relationship, minimised aggravation & litigation, competency (planning and implementing reconstruction programmes), shorter contract time, timelines (progress schedule), delivery speed in construction process and lead-time, to budget delivery/appropriate to budget, higher standard of quality/exceed quality standards, teamwork development, productivity of resources, efficiency of leadership and coordination, communication technique and documentation, financial stability during a relationship, risk management skills & techniques, availability of resources (material, labour, & plant), and capability of sourcing. Quadrant 3, includes long-term business relationship, continuous learning & improvement, appropriate tangibles (site facilities, documentations, claims & reports), understanding client, accuracy of variations/invoices & claims, potential for innovation & creativity, whole life cost

and Value for Money, information system adequacy, accuracy of decision making, improved organisational culture, employee empowerment, perceived prosocial behavior (friendly environment, no blame culture, respect, fairness, good faith & attitude), environmental protection. Finally, values such as efficient problem resolution procedure, lower contract price, accessibility & responsiveness, and providing necessary guarantees/assurance were located in Quadrant 4.

In addition, the line of equality determines the points that have the same value from both a public and private client perspective. As shown in Figure 2, the diagonal line identifies two areas. The area above the diagonal line includes values that are more important for public clients. The area below the diagonal line includes values which are more important for private clients. Distance from the line indicates the extent to which the importance level of each value criterion is different based on public and private client perspective.

Analysing the four quadrants as well as the two areas determined by the line of equality indicate there is strong agreement between all public and private respondents. For example, 80 percent of the values (31 out of 39) fell into quadrants 2 and 3 which show these values are highly important for both types of respondents. Also, it appears from Figure 2, that most of the values are located close to the line of equality.

5. DISCUSSION

During post-disaster reconstruction projects clients deal with greater uncertainty (Hayles, 2010; Sun and Xu, 2010) and complexity (Bello, 2006; Boano and García, 2011; Coffey and Trigunarsyah, 2012; Ye and Okada, 2002), in comparison with business-as-usual situations. Hence, managing construction activities in post-disaster situations, are modified from business-as-usual situations (Le Masurier et al., 2006; Prieto and Whitaker, 2011) inducing changes to client prioritisations (Aliakbarlou et al., 2017d). For example, meeting client expectations, particularly within terminal values (e.g. time, cost, and quality), has been the focus of several studies in business-as-usual construction literature (Holt et al., 1994; Hatush and Skitmore, 1997; Topcu, 2004; Plebankiewicz, 2010; Shen et al., 2006; Marzouk, 2008). However, this study's findings indicate that the New Zealand client perception of contractor assessment for post-disaster reconstruction differs from business-as-usual. For example, one of the key recurring themes from this study is the recognition of the instrumental values as a key strategic variable to meet New Zealand client expectations in post-disaster situations.

In business-as-usual, where clients have a deep rooted cost driven agenda (Taylor, 1998), the lowest bidders are awarded the contracts. However, according to this study's findings price is not considered to be a core client value in the post-disaster situation. This highlights the need for the New Zealand construction industry to reduce its emphasis on lowest contract price and seek an approach which can provide better services to clients.

In post-disaster reconstruction situations, clients put more emphasis on values such as availability of resources, timeliness, competency, building a trust based relationship, financial stability, and communication techniques in comparison with contract price (Aliakbarlou et al., 2017c). Assessing instrumental values as intangible aspects of contractual relationships is of interest in various industries (Jin et al., 2013). Through this study its importance for New Zealand construction clients has also been highlighted. While terminal values can still remain as clients' important values within contacting services, assessing instrumental values as

intangible aspects of contractual relationships is essential for clients in post-disaster reconstruction projects (Aliakbarlou et al., 2017b). In other words, improving instrumental values within contractual relationships can be seen as a powerful strategic approach that service providers should use to improve their competitiveness, particularly for post-disaster reconstruction projects.

6. CONCLUSION

This study highlighted the client terminal and instrumental values within contracting services in post-disaster situations. It is suggested that developing appropriate strategies for delivering the identified values can help contractors to provide better value to their client. The findings indicate that contractors should not perform only based on terminal values, as there are other (instrumental) values, which make one contractor more valuable than another to clients.

The study's findings indicate that New Zealand public and private clients have similar perceptions regarding the importance levels of the identified values in assessing their post-disaster reconstruction contracting services. In addition, the study, using quadrant analysis, highlighted that partnerships with all parties, efficiency of construction methods and techniques, security, health and safety, and willingness to use local resources are slightly more important for public clients. Also, efficient problem resolution procedures, lower contract price, accessibility & responsiveness, and providing necessary guarantees/assurance are slightly more important for private clients.

The main research limitations and recommendations for further research are as follow. The client values identified in this study were based on New Zealand experts' perspective, which could be different from other countries. It would also be interesting to see how the result of this study can be generalised across other countries. In addition, investigating how contractors comply with the identified values in post-disaster situations is an important further research area.

7. REFERENCES

- Abeka, S. O. and Ochieng'abeka, E. (2012). "Percieved Importance and Perfomance of Information Systems in Azam Company-Dar Es Salaam." *International Journal of Learning and Development*. 2(3), 9-24.
- Ahmed, I. (2011). An overview of post-disaster permanent housing reconstruction in developing countries. *International Journal of Disaster Resilience in the Built Environment*, 2(2), 148-164.
- Ahmed, S. M., & Kangari, R. (1995). Analysis of client-satisfaction factors in construction industry. *Journal of Management in Engineering*, 11(2), 36-44
- Aliakbarlou, S., Wilkinson, S. and Costello, S. B. (2017a). "Exploring construction client values and qualities: are these two distinct concepts in construction studies?" *Built Environment Project and Asset Management Journal*. 7(3), forthcoming.
- Aliakbarlou, S., Wilkinson, S., Costello, S. B. and Jang, H. (2017b). "Achieving post-disaster reconstruction success based on satisfactory delivery of client values within contractor's services." *ASCE Journal of Management in Engineering*. under review.
- Aliakbarlou, S., Wilkinson, S., Costello, S. B. and Jang, H. (2017c). "Client values within post disaster reconstruction contracting services." *Disaster Prevention and Management: An International Journal*. 26(3), 1-15.
- Aliakbarlou, S., Wilkinson, S., Costello, S. B. and Jang, H. (2017d). "Conceptual Client Value Index for Post Disaster Reconstruction Contracting Services." *KSCE Journal of Civil Engineering*. forthcoming.
- Barakat, S. (2003). "Housing reconstruction after conflict and disaster." *Humanitarian Policy Group, Network Papers*. 43, 1-40.

- Bello, W. (2006). "The rise of the relief-and-reconstruction complex." *Journal of International Affairs*. 281-296.
- Bertelsen, S. and Emmitt, S. "The client as a complex system". 13th International Group for Lean Construction Conference: Proceedings, 2005 2005 Sydney. International Group on Lean Construction, 73.
- Boano, C. and García, M. (2011). "Lost in translation? The challenges of an equitable post-disaster reconstruction process: Lessons from Chile." *Environmental Hazards*. 10(3-4), 293-309.
- Boyd, D. and Chinyio, E. 2008. *Understanding the construction client*, John Wiley & Sons.
- British Standard Institute. (2014). PAS 1192-2: Specification for information management for the capital/delivery phase of construction projects using building information modelling. London: BSI Group
- Chapman, R. G. (1993). "Brand performance comparatives." *Journal of Product & Brand Management*. 2(1), 42-50.
- Chéron, E. J., Mctavish, R. and Perrien, J. (1989). "Segmentation of bank commercial markets." *International Journal of Bank Marketing*. 7(6), 25-30.
- Chua, D. K. H., Kog, Y.-C. and Loh, P. K. (1999). "Critical success factors for different project objectives." *Journal of construction engineering and management*. 125(3), 142-150.
- Coffey, V. and Trigunarsyah, B. "Rebuilding housing after a disaster: factors for failure". Proceedings of 8th Annual International Conference of the International Institute for Infrastructure, Renewal and Reconstruction (IIRR), 2012. Kumamoto University, 292-300.
- Construction Strategy Group. (2015). The NZ Industry. Retrieved from <http://www.constructionstrategygroup.org.nz/industry.php>
- Emmitt, S., Sander, D. and Christoffersen, A. K. "The value universe: defining a value based approach to lean construction". 13th International Group for Lean Construction Conference: Proceedings, 2005. International Group on Lean Construction, 57.
- Hallowell, M. R., & Gambatese, J. A. (2009). Qualitative research: Application of the Delphi method to CEM research. *Journal of construction engineering and management*, 136(1), 99-107.
- Hatush, Z. and Skitmore, M. (1997). "Criteria for contractor selection." *Construction Management & Economics*. 15(1), 19-38.
- Hayles, C. S. (2010). "An examination of decision making in post disaster housing reconstruction." *International Journal of Disaster Resilience in the Built Environment*. 1(1), 103-122.
- Holt, G. D., Olomolaiye, P. O. and Harris, F. C. (1994). "Evaluating performance potential in the selection of construction contractors." *Engineering, Construction and Architectural Management*. 1(1), 29-50.
- Ibrahim, C. K. I. C., Costello, S. B. and Wilkinson, S. (2014). "Establishment of quantitative measures for team integration assessment in alliance projects." *Journal of Management in Engineering*. 31(5), 04014075.
- Ika, L. A., Diallo, A. and Thuillier, D. (2012). "Critical success factors for World Bank projects: An empirical investigation." *International Journal of Project Management*. 30(1), 105-116.
- Jin, Z., Deng, F., Li, H. and Skitmore, M. (2013). "Practical framework for measuring performance of international construction firms." *Journal of Construction Engineering and Management*. 139(9), 1154-1167.
- Kelly, J. (2007). "Making client values explicit in value management workshops." *Construction Management and Economics*. 25(4), 435-442.
- Kelly, J., Morledge, R. and Wilkinson, S. J. 2009. *Best value in construction*, John Wiley & Sons.
- Koria, M. (2009). "Managing for innovation in large and complex recovery programmes: Tsunami lessons from Sri Lanka." *International Journal of Project Management*. 27(2), 123-130.
- Le Masurier, J., Rotimi, J. O. and Wilkinson, S. (2006). "Comparison between routine construction and post-disaster reconstruction with case studies from New Zealand."
- Lyons, M. (2009). "Building back better: the large-scale impact of small-scale approaches to reconstruction." *World Development*. 37(2), 385-398.
- Marzouk, M. (2008). "A superiority and inferiority ranking model for contractor selection." *Construction Innovation*. 8(4), 250-268.
- Masterman, J. 2003. *An introduction to building procurement systems*, Routledge.
- Meding, V., Kyle, J., Oyedele, L., Cleland, D., Spillane, J. and Konanahalli, A. (2011). "Mapping NGO Competency to Reduce Human Vulnerability in Post-disaster Communities: Comparing Strategies in Sri Lanka and Bangladesh." *International Journal of the Humanities*. 8(11).
- Norling, B. "Effective Time Management in Post-Disaster Reconstruction". Australian and New Zealand Disaster and Emergency Management Conference, 2013. 1-10.
- Okoli, C., & Pawlowski, S. D. (2004). The Delphi method as a research tool: an example, design considerations and applications. *Information & management*, 42(1), 15-29.
- Pelling, M., Maskrey, A., Ruiz, P., Hall, P., Peduzzi, P., Dao, Q.-H., Mouton, F., Herold, C. and Kluser, S. (2004). "Reducing disaster risk: a challenge for development."
- Perry, R. B. (1914). "The definition of value." *The Journal of Philosophy, Psychology and Scientific Methods*. 11(6), 141-162.

- Plebankiewicz, E. (2010). "Construction contractor prequalification from Polish clients' perspective." *Journal of Civil Engineering and Management*. 16(1), 57-64.
- Prieto, B. and Whitaker, C. (2011). "Post Disaster Engineering and Construction Program and Project Management." *PM World Today*. 13(9), 1-19.
- Rapp, R. R. 2011. *Disaster recovery project management: Bringing order from chaos*, Purdue University Press.
- Rotimi, J. O., Wilkinson, S., Zuo, K. and Myburgh, D. (2009). "Legislation for effective post-disaster reconstruction." *International Journal of Strategic Property Management*. 13(2), 143-152.
- Shen, L.-Y., Lu, W.-S. and Yam, M. C. (2006). "Contractor key competitiveness indicators: a China study." *Journal of Construction Engineering and Management*. 132(4), 416-424.
- Sohn, T.-H., Kim, H.-R. and Jang, H.-S. (2014). "An MDB business competency assessment of Korean construction companies." *KSCCE Journal of Civil Engineering*. 18(5), 1314-1321.
- Sun, C. and Xu, J. (2010). "Estimation of time for Wenchuan Earthquake reconstruction in China." *Journal of Construction Engineering and Management*. 137(3), 179-187.
- Sun, C. and Xu, J. (2011). "Estimation of time for Wenchuan Earthquake reconstruction in China." *Journal of Construction Engineering and Management*. 137(3), 179-187.
- Taylor, S. (1998). "Can partnering work for you." *Contract Journal*, pp18-19 January.
- Thomson, D. S., Austin, S. A., Devine-Wright, H. and Mills, G. R. (2003). "Managing value and quality in design." *Building Research and Information*. 31(5), 334-345.
- Topcu, Y. I. (2004). "A decision model proposal for construction contractor selection in Turkey." *Building and environment*. 39(4), 469-481.
- Volker, L. 2010. *Deciding about design quality: Value judgements and decision making in the selection of architects by public clients under European tendering regulations*, Sidestone Press.
- Von Meding, J. (2008). "Dynamic competency theory in post-disaster reconstruction."
- Wandahl, S. 2002. *Værdibaseret samarbejde-processtyring skaber højere produktværdier for alle (Value-Based Cooperation-process controls gains higher product value for everybody)*. M. sc.-thesis, Department of Production, Aalborg University.
- Wandahl, S. and Bejder, E. "Value-based management in the supply chain of construction projects". The 11th annual conference on Lean Construction, Blacksburg. Edt.: Martinez and Formoso, 2003. Citeseer.
- Wilkinson, S., Gupta, S. and Le Masurier, J. (2005). "The development of a contractual framework for disaster reconstruction." *Understanding the Construction Business and Companies in the New Millennium*. 44.
- Yang, J.-B. and Peng, S.-C. (2008). "Development of a customer satisfaction evaluation model for construction project management." *Building and Environment*. 43(4), 458-468.
- Ye, Y. and Okada, N. "Integrated relief and reconstruction management following a natural disaster". Second annual IIASA-DPRI meeting, Integrated disaster risk management: megacity vulnerability and resilience, 2002.
- Zhang, J., Zou, W. and Kumaraswamy, M. (2015). "Developing public private people partnership (4P) for post disaster infrastructure procurement." *International Journal of Disaster Resilience in the Built Environment*. 6(4), 468-484.
- Zuo, K. X. 2010. *Procurement and contractual arrangements for post-disaster reconstruction*. PhD thesis, University of Auckland, Auckland.

INTEGRATING SOCIAL SUSTAINABILITY IN THE SOUTH AFRICAN CONSTRUCTION INDUSTRY: BENEFITS AND BARRIERS

B. Awuzie and T. Monyane

Central University Of Technology, FS, South Africa

Email: bawuzie@cut.ac.za

Abstract: The concept of social sustainability often appears to be neglected in the construction industry's quest to optimally mainstream sustainability. The paucity of studies on this concept, especially in the developing country context, is indicative of this neglect. Reasons adduced for this neglect include the inability of stakeholders to identify benefits associated with social sustainability and the opportunities available for its integration during project procurement and delivery. This observation makes this study, imperative. This phenomenological study set out to identify benefits associated with the integration of social sustainability into delivery of infrastructure projects from a client's perspective. Semi-structured interviews were used to collect data from a purposively selected sample of infrastructure clients. Subsequently, the data was analysed using thematic analysis. Findings indicate that social sustainability integration in projects had the potential to bring about significant benefits, such as increased respect for people, sufficient buy-in by community, hence enabling successful project performance. Also, it was discovered that opportunities for such integration was available throughout the project delivery life-cycle. However, a low level of awareness pertaining to social sustainability in the South African construction industry was observed. It is expected that the study's findings will contribute to engendering improved levels of awareness among infrastructure clients on the utility of such integration in their projects, especially within the South African construction industry context.

Keywords: Clients, Construction Industry, Infrastructure, Social sustainability, South Africa

1. INTRODUCION

The concepts of sustainability and sustainable development (SD) have remained central to policy and academic discourse in the 21st century. Whereas sustainability in itself has been ascribed the status of a desirable state for society (utopia), SD on the other hand consists of the developmental strategies or processes required to attain such state (Boström, 2012). Renewed interest in these concepts can be traced to the Bruntland report published under the auspices of the World Commission for Environment and Development, three decades ago. Since then, the uptake of ideals associated with the drive for a sustainable society has intensified.

Yet, buy-in into these concepts within the developing country context only attained significant proportions only after the United Nations World Summit on Sustainable Development (WSSD) in 2002 (Rydin, 2012). This summit bought about increased awareness among nations, especially African nations, concerning the imperative nature of sustainability and SD respectively. Significant frameworks like the millennium development goals (MDG) and its successor, the sustainable development goals (SDGs) have been developed and adopted. The latter is expected to govern the actualization of a sustainable society between 2015 and 2030.

Processes within economic sectors like construction have since been targeted, resulting in new taxonomies like 'sustainable construction', 'responsible sourcing', 'sustainable procurement', 'green construction' etc. This is premised on the industry's reputation for making adverse contributions towards society's quest to become sustainable, given its anthropogenic nature.

Obviously, society requires the products delivered by the construction industry to attain and maintain sustainability (Sourani & Sohail, 2005). The relationship between infrastructure, improved productivity levels and economic growth has been reiterated in extant literature (Esfahani & Ramirez, 2003). Efforts are continually being made by stakeholders within the industry to mainstream SD dimensions into industry practices. Whilst developed countries have taken a lead in this aspect, developing countries appear to be lagging behind.

In seeking to adopt global best practices associated with the SD agenda, construction industry stakeholders in South African have made spirited attempts to integrate SD dimensions (Du Plessis, 2002). On the surface, it would appear that the country has fared differently from its peers in the developing world by focusing immensely on the environmental, social and economic dimensions during the procurement and eventual delivery of assets. This is evident in the various preferential procurement practices which have remained prevalent in the country till date (Bolton, 2006; Watermeyer, 1999; Watermeyer, Gounden, Letchmiah, & Shezi, 1998). However, a paucity of studies exploring the implementation of these sustainability dimensions in the country's construction industry has been observed. This is particularly so for the social sustainability (SS) dimension; hence prompting this inquest.

This study seeks to contribute to the emerging body of knowledge on SS dimensions within the construction industry and developing country context respectively by exploring its integration into the South African context. Furthermore, it is expected that findings from the study will elucidate the benefits, opportunities and barriers to the effective integration of social sustainability in the industry's project delivery pathways. However, this study seeks to focus only on the perspectives of relevant stakeholders within infrastructure client organisations (ICOs). This is in recognition of the critical role they assume in championing the sustainability agenda during infrastructure delivery.

To achieve its objective, the paper is structured into the following sections, namely; a review of relevant literature regarding the concept of SS and its application in the South African construction industry, as well as the role of ICOs in SS implementation. These will be followed by a brief description of the research methodology adopted in this study, a presentation and discussion of the findings as well as the conclusion.

2. OPERATIONALIZING SOCIAL SUSTAINABILITY IN THE SOUTH AFRICAN CONSTRUCTION INDUSTRY

The SS dimension evolved from the broadly accepted categorization of the sustainability into three pillars to enable the operationalization of the concept (Elkington, 1999). Prior to this categorization, sustainability as a concept had remained vague, being used by politicians and policy makers to score cheap political points (Christen & Schmidt, 2012; Sneddon, Howarth, & Norgaard, 2006). However, whereas the economic and environmental dimensions have been accorded significant attention by society, SS is only starting to get some attention (Boström, 2012; Peterson, 2016). Missimer, Robèrt, and Broman (2017) reiterate the non-integration of SS into the Framework for Strategic Sustainable Development (FSSD), a renowned framework for driving SD.

Defying any commonly accepted definition, SS has been considered context-specific unlike other pillars (Dempsey, Bramley, Power, & Brown, 2011; Littig & Griebl, 2005; McKenzie, 2004). Besides contributing to the attendant vagueness and interpretative flexibility associated

with the concept, this indefinability has adversely affected its realization and operationalization in economic sectors like construction (Boström, 2012). In addition, the realization and operationalization of SS is deterred by attempts of scholars to present the three sustainability dimensions as standing alone, rather than being mutually supportive and compatible (Peterson, 2016; Weingaertner & Moberg, 2014). According to Abdel-Raheem and Ramsbottom (2016), practicing green construction (environmental sustainability), results in savings in the operation cost on the long run (economic sustainability), and provide healthy work environment for the workforce (social sustainability). Scholars like Dempsey et al. (2011) have alluded to the dynamic and fluid nature of SS, insisting that what connotes SS within a particular context is likely to change over a particular duration. This makes for difficult comprehension of the concept. Boström (2012) categorizes these obstacles which exist in relevant literature into two broad categories namely; theoretical and practice-oriented obstacles. Whereas the theoretical obstacles encompass the notion of how to define and understand the concept of social sustainability, the latter is concerned with how to effectively operationalize and integrate the concept into projects.

Furthermore, scholars have evolved different ways of approaching SS. For instance, whereas Magis and Shinn (2009) view the concept from the human well-being, equity, democratic government and democratic civil society perspective, Murphy (2012) opines that SS rests on four dimensions, namely: equity, awareness, participation and social cohesion. Boström (2012) advocates for the consideration of SS as a conceptual tool for framing communication, decision-making, carrying out assessment of contemporary developments, among policy makers and stakeholders. Consequently, he categorizes SS aspects into substantive aspects-aspects dealing with what SS goals to achieve in a particular context; and procedural aspects-aspects dealing with SS elements that foster sustainable development. The challenges faced in the incorporation of SS has to do with the lack of attention by stakeholders to the extant synergy between these aspects. Whitton, Parry, Akiyoshi, and Lawless (2015) add that SS involves aspects such as community cohesion, human well-being, effective dialogue, and access of citizens to decision making levels within their respective communities.

Weingaertner and Moberg (2014) explore SS from the urban development, companies and products perspectives and conclude that there seems to be a common understanding of what SS entails across these sectors. They provide, three themes for developing such understanding, namely: social capital, human capital and well-being. Also, Vallance, Perkins, and Dixon (2011) attempt to provide clarity in the description of SS by proposing three paradigms namely, development, bridge, and maintenance sustainability respectively. Development sustainability focuses on the satisfaction of tangible or intangible needs of humans whilst bridge sustainability focuses on transforming negative societal behaviour towards the environment and bringing about stronger environmental ethics. Maintenance sustainability pertains to understanding how the social and cultural preferences and features are maintained over a certain duration in a certain context. From the foregoing, it is evident that a lack of consensus concerning the SS concept still persists in the extant body of knowledge. No doubt, this has further affected the development of a concise set of indicators for measuring the performance of SS integration in projects and thus, its optimal integration.

The construction industry, both globally and locally, is by no means immune from the import of the vagueness associated with SS. Valdes-Vasquez and Klotz (2013) attest to this, decrying the absence of a comprehensive and empirical framework for defining SS within the context of construction projects owing to its indefinability. Herd-Smith and Fewings (2008) propose that SS in construction be used to refer to the engagement among employees, local communities,

clients, and the supply chain to ensure meeting the needs of current and future populations and communities. Yet, Valdes-Vasquez and Klotz (2013) observe that an understanding of this definition was contingent on stakeholder type and the project’s lifecycle phase. They posit that one perspective of SS entails the estimation of the impact of construction projects in relation to where users habit, work and engage in various activities, a perspective usually catered for during environment impact assessment. Also, the application of corporate social responsibility (CSR) objectives by construction firms and client organizations was identified as another approach to SS. Other perspectives highlighted therein bother on design initiatives for engendering social inclusion for under-represented groups, and elimination of safety hazards from the work site, impact of temporary users like workforce and vendors as well as extant social interactions etc. Furthermore, they insist that SS was process-oriented, reiterating six key themes for exploring the incorporation of SS processes in the planning and design phase of the construction process. These key themes include stakeholder engagement; user considerations; team formation; management considerations; impact assessment, and; place context. Similarities were observed between the themes provided by Valdes-Vasquez and Klotz (2013) and those espoused by Sourani and Sohail (2005), Abdel-Raheem and Ramsbottom (2016), Herd-Smith and Fewings (2008). See Table 1.

Table 1: Social Sustainability Dimensions in Construction Themes

Stakeholder engagement	<p>Determine the expectations of the owner, designer, and public early in the project; Respond quickly to community concerns and perceptions; Engage local governments in design so that decision makers can understand and anticipate their needs; Generate a stakeholder management plan that encourages interaction, integration, and collaboration among Stakeholders; Inform stakeholders of the project constraints (e.g., budget, schedule, location, size, design, and construction standards); Ensure participation of final users in design so that decision makers can understand and anticipate their needs; Establish partnering strategies for resolving interpersonal conflicts among project stakeholders; Educate the public about the planning/design progress; Encourage neighborhood engagement in the design; Document and share the lessons learned during the planning and design phases with all stakeholders; Communicate the deliverables and intended project outcomes with each stakeholder group; Communicate the rationale for the commissioning process to the stakeholders.</p>
User considerations	<p>Use an evidence-based design process, basing decisions about the built environment on valid and reliable research; Adopt designs that increase the wellness and productivity of the final users; Establish a plan to evaluate progress on zero harm or zero accident targets for the project; Include security considerations for the final users in the project design; Establish requirements to assess the impact of the project on the health and safety of the final users; Provide a plan to minimize disruption caused by the construction process (e.g., traffic congestion, dust, and noise); Design to consider the job skills of the women, young people, unemployed, disadvantaged, racial, and ethnic minority groups in the area; Monitor and respond to incidents of corruption.</p>
Team formation	<p>Select a diverse design team including participants from various professions, genders, races, and firm sizes; Include health professionals in the design team to help analyze health impacts on the final users and the community; Select design and construction firms with a sustainability focus; Use local designers and professionals; Use an integrated design–construction process.</p>
Management Considerations	<p>Design to enable the use of local construction labor; Train designers to help them address future hazards during the construction and maintenance phases of the project; Establish zero harm or zero accident targets for the project; Incorporate safety prevention techniques that prevent or minimize occupational hazards and risks during construction (e.g., the analysis of the sequence of construction activities and the use of prefabrication techniques); Require a management plan for improving construction worker productivity; Require education, training, counseling, prevention, and risk-control programs to assist workforce members and their families or community members regarding serious diseases;</p>

	Use local material/product suppliers for the project;
Impact assessment	<p>Conduct a social impact assessment of the project;</p> <p>Conduct a social life cycle analysis of construction products and materials that considers workforce safety and health;</p> <p>Conduct a health impact assessment;</p> <p>Analyze the effect of the project on cultural, historical, and archeological resources;</p> <p>Incorporate social considerations (e.g., health, productivity, and quality of life) into a return on investment analysis (ROI);</p> <p>Assess the impact of introducing new social classes into the surrounding community (e.g., a community in which low-income housing is proposed might perceive the new social class as a threat based on stereotypes and misconceptions);</p> <p>Analyze new/additional community infrastructure needs resulting from the project (e.g., water, power, and emergency responders);</p> <p>Assess the results from post-occupancy evaluation of similar projects;</p> <p>Analyze the impact of the project on the cultural and ethnic identity of the surrounding community;</p> <p>Assess seasonal population changes in the surrounding community and their effect on employment patterns, business practices, and community infrastructure;</p> <p>Analyze the impact of the project location on access to public transit, biking opportunities, safe walking routes, and green spaces;</p>
Place context	<p>Include privacy considerations for the final users;</p> <p>Create design features that instill pride in ownership of the users and the surrounding community;</p> <p>Include human interaction (connectivity) considerations for the final users in the project design;</p> <p>Perform an asset-based design analysis of the surrounding community so that design solutions can convert social liabilities into assets;</p> <p>Assess the planning and zoning decisions of organizations/institutions with jurisdiction over the proposed project area;</p> <p>Develop a plan for ongoing evaluation of the impact of the project on surrounding communities once it is in operation;</p> <p>Maintain and/or restore natural habitat important to the final users and the surrounding community;</p>

Source: Adapted from Valdes-Vasquez and Klotz (2013)

It is pertinent to note that this particular study aligns itself to these views as espoused by Valdes-Vasquez and Klotz (2013) pertaining to SS as consisting of a set of processes required to improve on the construction industry’s contribution to the SD agenda. In addition, it concurs with the categorization proposed by Vallance et al. (2011) wherein an integration of the pillars is deemed to be essential to understanding the nature of SS as it applies to the need to sustain the interaction between humankind and the bio-physical aspects of society in manner that guarantees improved well-being and social equity. The contents of Table 1 further affirm the interwoven nature of these pillars.

South Africa is renowned for its apartheid struggles in the pre-1990 era. In the post-apartheid era, which also marked the escalation of the SD mantra, efforts have been made to achieve improved levels of social inclusion of hitherto under-represented groups in the country. Cross-sectoral efforts have led to promulgation of policies by government and stakeholders to curb agitations for social inclusion. Such policies have sought to provide economic emancipation for certain groups, provide increased access to employment opportunities, skill development, social housing, education, healthcare, etc. (Bolton, 2006). In the construction industry, the use of preferential procurement practices and the integration of social benefits in the decision making processes for new projects has been noted (Jacquet, 2002; Rogerson, 2012; Watermeyer, 1999). However, these agitations have continued unabated, hence prompting this exploratory study into the integration of SS in the construction industry’s processes. Additionally, the assets delivered by this sector have contributed in shaping the nature of society and can be applied towards transforming societal values (Hawkins & Wells, 2006).

However, the influence of stakeholders such as ICOs in bringing about such transformation through the successful integration of SS into the project delivery processes in the industry cannot be underestimated (Adetunji, Price, Fleming, & Kemp, 2003; Awuzie & McDermott, 2016). This was the major consideration in the decision of the authors to ascertain the perception of this group of stakeholders concerning this particular phenomenon.

2.1 Social sustainability and infrastructure client organisations

The fragmented nature of the construction industry and infrastructure delivery systems in particular, contributes significantly to the difficulty in implementing policy objectives during various phases of the project delivery lifecycle. The dynamics of power experienced during these stages among stakeholders further aggravates the levels of extant tension hence resulting in poor implementation of construction projects. However, scholars have attested to the powerful nature of clients in championing the implementation of project objectives during project delivery (Vennström & Erik Eriksson, 2010). Yet, this study is not oblivious of the difficulty surrounding client identification, especially within the realm of public infrastructure delivery systems (Boyd & Chinyio, 2008). Client status has been ascribed to the users of the infrastructural facility in some instances whilst the owners have been described as project owners or sponsors. In this particular study, the ICOs are referred to as project clients.

An ICO's ability to drive SS integration is evident, especially through their procurement strategies. According to Valdes-Vasquez and Klotz (2013), this can take place through consultation with the users, engagement of other stakeholders, formation of the appropriate team, conduct of impact assessment exercises amongst others. In consideration of the influence wielded by such entities in this regard, this study seeks to ascertain their perception regarding the integration of SS into their projects.

3. RESEARCH METHODOLOGY

This qualitative study adopts a phenomenological research design. The choice of this design was an afterthought as a qualitatively driven case study research design had initially been proposed. This was based on the case study's pre-eminence in the conduct of context dependent studies such as this (Stake, 2005; Yin, 2013). Furthermore, its reputation for engendering an in-depth investigation of a phenomenon within its natural context is legendary. The authors identified an ICO- an infrastructure and engineering services directorate, nested within one of the metro municipalities in the country. Organizational consent was sought through a letter to the head of the directorate. Although consent was readily obtained, attempts to assemble the various project teams proved onerous for focus group interactions, initially and one-on-one interviews, eventually proved unsuccessful. Although the authors initially agreed to rely on case studies of ICOs in South Africa and as it were, study their approach to SS integration the eventual choice of the phenomenological research design did not detract from validity of the study's findings.

The authors had to rely on the experiences of certain staff of this organization and other organizations who indicated willingness to be interviewed, when approached. In total, thirteen semi-structured interviews were conducted with such individuals between August, 2016 and November, 2016 in Port Elizabeth and Bloemfontein. These interviewees consisted of project managers and a head of directorate who shared a total of 142 years' experience in infrastructure

procurement and delivery in the public sector between them, suggesting an average of 17.75 years' experience. The choice of semi-structured interviews was predicated on its provenance as a reliable data elicitation technique which provided the interviewer with considerable levels of flexibility in his/her desire to explore the worldviews of interviewees concerning a particular phenomenon (Bernard & Ryan, 2009). Such flexibility was reflected in the use of similar and not identical questions thus enhancing the interviewer's ability to take the interviewer's level of experience into consideration in the choice of questions. The font size and style of the heading of the conclusion and references section is similar to first level heading font size and the styles. Leave two single spaces between the paragraph of the previous section and the conclusion heading.

These interviews held in the interviewees' offices, spanning an average of thirty minutes, each. The interview sessions were recorded with express permission of interviewees and subsequently transcribed, verbatim. Questions asked during the interviews were centred on their understanding of the SS concept as applied in infrastructure delivery systems and their perceptions of the barriers, benefits and opportunities derived therefrom. Thematic analysis was applied in making sense of the data (Kulatunga, Amaratunga, & Haigh, 2007). The emergent data is presented and discussed in subsequent sections.

4. PRESENTATION AND DISCUSSION OF FINDINGS

The presentation and discussion of the study's findings will be presented concurrently under the various themes and subthemes. Although a diverse set of subthemes were identified, only a few of them are reported in this section.

4.1 Barriers

The corpus of sustainability/SS/SD literature is replete with references to various factors which have served to undermine the effective mainstreaming of SS in various sectors of the economy, particularly construction and infrastructure delivery. The authors identified these impediments and relied upon them as subthemes for coding the interview transcripts.

4.2 Limited understanding of social sustainability

Several authors appear to concur that the lack of awareness concerning SS adversely affects its integration in on-going SD efforts (Littig & Grießler, 2005; Valenzuela Musura & Albarosa, 2017). Such low levels of awareness have been attributed to the inability of practitioners and policy makers and academics to arrive at a consensus concerning the definition of the concept. Herd-Smith and Fewings (2008) posit that such low levels is responsible for its neglect during the delivery of construction projects, when compared to other pillars. In the context of the South African construction industry, this statement holds through. From the interviews, a limited understanding was discovered regarding what SS connotes within the industry. The interviewer had to explain SS aspects to the thirteen interviewees during their interview sessions as most of them feigned ignorance of them.

For most of the interviewees, SS entailed improving access to employment for underrepresented races, widen communal sources of livelihood and providing skills for persons hitherto deemed economically inactive. Whilst these can be described as salient SS aspects as

shown in Table 1, no mention was made of other SS aspects of such as improved safety conditions on work site, fair labour conditions for workers; effective mainstreaming of women and foreign (migrant) workers as well as other underrepresented groups besides racial groups during construction etc. When the second author prompted some interviewees on their approach towards these issues, especially health and safety (H&S) related issues, they affirmed that adequate consideration was accorded to H&S issues on their projects. This further affirms the notion that there is a limited understanding among stakeholders on the nature and composition of SS. Also, the responses obtained from these interviewees, unintentionally indicate the presence of a nexus between economic and social sustainability dimensions without regard for the environmental dimension as the latter is treated as being separate.

4.3 Absence of standardized set of indicators for measurement

Another obstacle confronting SS integration is the absence of a universally accepted set of indicators for measuring implementation performance. Due to this, it is difficult for integration proponents to convince project owners to proceed champion integration unlike the case with the environmental and economic dimensions which have concrete indicators. The interviewers sought to know if the interviewees had applied any indicators in measuring the impact of SS aspects which had previously been explained to them by the interviewers, on project performance. Interviewees stated that they were not aware of any tools or set of indicators for measuring the impact of SS on project performance besides eliciting the reactions of the host community on the utility of the project during the various phases of the project delivery exercise through consultation exercises with residents of the host community where such projects were (being) situated. This does not come as a surprise as the interviewees had earlier showed limited awareness concerning SS and therefore not be able to provide indicators associated with SS integration besides the example rendered above.

4.4 Benefits

Although a plethora of benefits have been identified in the literature and the interview sessions as accruable from the effective SS integration and other SD dimensions in the construction industry, only a few of these benefits would be discussed herein.

4.5 Improved job creation opportunities for locals through alignment of contracting strategies to SS objectives

Contracting strategies have been described as enablers of the SS integration in construction projects and the construction industry in general (Hawkins & Wells, 2006; Watermeyer et al., 1998). The choice of which contracting strategy to utilize in the realization of a construction project should be aligned to the SS criteria being sought to be achieved by the project owners and end users. Evidence of this abounds within the South African context wherein the use of targeted/preferential procurement policies and work packages such as unbundling has been used in getting hitherto underrepresented communities in the construction industry. Interviewees regaled the interviewers with scenarios where they had applied preferential procurement strategies to assist contractors who were members of a particular community to tender, win and execute work packages in their respective organizations. The interviewers were further inundated by an interviewee (HoD) on how his department had initiated training

programmes for a select group of novice contractors from the local area. Such programmes which were referred to as Vukuphile (wake up and live) and Mangaung Community plumbers respectively were meant to develop technical, administrative and financial management competencies among contractors. In the aftermath of their tutelage, these individuals are availed opportunities on work packages owned by the directorate. It is beyond the scope of this study to ascertain the success of these schemes. However, it is pertinent to note once more that this instance highlights the nexus between social and economic sustainability from the client's perspective.

4.6 Increased societal acceptance of infrastructure projects

The incorporation of the views of stakeholders as well as the ensuring that tenets relating to respect for people is achieved during the early stages and subsequent stages of an infrastructure asset delivery lifecycle has been described as capable of inspiring high levels of societal acceptance by such stakeholders (Raven, Mourik, Feenstra, & Heiskanen, 2009; Suopajärvi et al., 2016; Whitton et al., 2015). They state that such levels of acceptance served as an operating capital for client organizations to proceed with their delivery exercise without hindrance hence resulting in improved levels of productivity and project performance. Furthermore, they affirm that effective management of social acceptance for new projects prevented the rise of potential problems. During the interview sessions, interviewees shared their experiences regarding how the consultation processes which are an essential part of the environmental impact assessment processes in South Africa for potential infrastructure projects enhanced the relationship between the local community, relevant stakeholders and the project delivery team. According to an interviewee, community participation in the early stages of their projects culminated in optimal project performance. The interviewees were unanimous on the pros of effective consultation processes, a significant SS aspect, yet when they were asked to identify processes for participant selection for these consultation exercises, they became hesitant to provide answers. Rather, they cited the Integrated Development Plan (IDP) and the Spatial Development Framework (SDF) prepared by different municipalities in South Africa as encapsulating the opinions expressed by stakeholders in the communities where relevant infrastructure and social housing were (being) situated. Owing to the reliance on the perspective of ICOs- a major shortcoming of this study, ascertaining the democratic nature of selection process becomes difficult. However, it is hoped that this shortcoming would be improved upon in subsequent studies into the same phenomenon.

4.7 Improved working conditions

The construction industry is renowned globally for the prevalence of poor working conditions (Lawrence, Gil, Flückiger, Lambert, & Werna, 2008). Workers in the industry have been exposed to long working hours with below market remuneration packages, especially for labourers. Also, the safety standards on site is often subject to incessant neglect by relevant stakeholders hence undermining health and safety issues on sight. Issues pertaining to access for disabled persons are often overlooked during site preparation. These are recurring issues within the construction industries in Sub-Saharan Africa, a community which South Africa forms an integral part. Upon further explanation of this benefit to the interviewees, they all acquiesced to the beneficial impact effective SS integration would have in restoring better working conditions in the construction industry and the construction sites in particular.

5. CONCLUSION

This study explored the mainstreaming of SS in the South African construction industry with emphasis on infrastructure delivery. To achieve its objective, it relied upon the worldviews of ICOs' representatives concerning their understanding of SS, their perception of barriers to optimal SS integration and the attendant benefits.

Findings corroborates extant literature concerning neglect of SS during SD implementation. Also, the indefinability of the concept and its context driven nature continues to pose significant obstacles to optimal integration. Furthermore, the consideration of the pillars of SD as distinct from one another was identified as a major barrier as all pillars were discovered to be mutually supportive and interdependent. However, within the context of the South African construction industry, much of the interdependence between the pillars was discovered to be between the social and economic sustainability dimensions leaving out the environmental dimension. Perhaps, this has contributed to the suboptimal SS integration. But, reasons can be readily adduced for this observation. The country's quest for unification and social inclusiveness has been predicated on economic empowerment of hitherto underrepresented groups, hence the relationship.

Summarily, the study highlights some salient barriers and benefits associated with SS integration in the South African construction industry. The study contributes towards developing the scant literature on SS integration in construction projects in developing countries. It is expected that its findings would raise stakeholder consciousness concerning the imperative nature of SS in sustaining the other pillars within SD implementation frameworks. Further studies will seek to explore the perspectives of all stakeholders in a systemic manner, and such information utilized in the development of a common definition for SS within the South African context. This, it is hoped will enable optimal integration.

6. REFERENCES

- Abdel-Raheem, M., & Ramsbottom, C. (2016). Factors Affecting Social Sustainability in Highway Projects in Missouri. *Procedia Engineering*, 145, 548-555.
- Adetunji, I., Price, A., Fleming, P., & Kemp, P. (2003). *Sustainability and the UK construction industry—a review*. Paper presented at the Proceedings of the Institution of Civil Engineers-Engineering Sustainability.
- Awuzie, B. O., & McDermott, P. (2016). The role of contracting strategies in social value implementation. *Proceedings of the ICE-Management, Procurement and Law*.
- Bernard, H. R., & Ryan, G. W. (2009). *Analyzing qualitative data: Systematic approaches*: SAGE publications.
- Bolton, P. (2006). Government procurement as a policy tool in South Africa. *Journal of Public Procurement*, 6(3), 193.
- Boström, M. (2012). A missing pillar? Challenges in theorizing and practicing social sustainability: introduction to the special issue. *Sustainability: Science, Practice, & Policy*, 8(1).
- Boyd, D., & Chinyio, E. (2008). *Understanding the construction client*: John Wiley & Sons.
- Christen, M., & Schmidt, S. (2012). A formal framework for conceptions of sustainability—a theoretical contribution to the discourse in sustainable development. *Sustainable Development*, 20(6), 400-410.
- Dempsey, N., Bramley, G., Power, S., & Brown, C. (2011). The social dimension of sustainable development: Defining urban social sustainability. *Sustainable Development*, 19(5), 289-300.
- Du Plessis, C. (2002). Agenda 21 for sustainable construction in developing countries. *CSIR Report BOU E*, 204.
- Elkington, J. (1999). Triple bottom-line reporting: Looking for balance. *Australian CPA*, 69, 18-21.
- Esfahani, H. S., & Ramirez, M. a. T. (2003). Institutions, infrastructure, and economic growth. *Journal of development Economics*, 70(2), 443-477.
- Hawkins, J., & Wells, J. (2006). Modifying infrastructure procurement to enhance social development. *African Technology Development Forum*, 4(4), 55.

- Herd-Smith, A., & Fewings, P. (2008). The implementation of social sustainability in regeneration projects: Myth or reality? Retrieved from doi:http://www.rics.org/site/scripts/download_info.aspx?fileID=3178&categoryID=525
- Jacquet, A. (2002). *Sustainable Contractor Development Through Coordinated and Focused Interventions*. Paper presented at the Proceedings, Built Environment Professions Convention.
- Kulatunga, U., Amaratunga, R., & Haigh, R. (2007). Structuring the unstructured data: the use of content analysis.
- Lawrence, R. J., Gil, M. P., Flückiger, Y., Lambert, C., & Werna, E. (2008). Promoting decent work in the construction sector: The role of local authorities. *Habitat International*, 32(2), 160-171.
- Littig, B., & Grießler, E. (2005). Social sustainability: a catchword between political pragmatism and social theory. *International journal of sustainable development*, 8(1-2), 65-79.
- Magis, K., & Shinn, C. (2009). Emergent principles of social sustainability. *Understanding the social dimension of sustainability*, 15-44.
- McKenzie, S. (2004). Social sustainability: towards some definitions.
- Missimer, M., Robèrt, K.-H., & Broman, G. (2017). A strategic approach to social sustainability—Part 1: exploring the social system. *Journal of Cleaner Production*, 140, 32-41.
- Murphy, K. (2012). The social pillar of sustainable development: a literature review and framework for policy analysis. *Sustainability: Science, Practice, & Policy*, 8(1).
- Peterson, N. (2016). Introduction to the special issue on social sustainability: integration, context, and governance. *Sustainability: Science, Practice, & Policy*, 12(1).
- Raven, R., Mourik, R., Feenstra, C., & Heiskanen, E. (2009). Modulating societal acceptance in new energy projects: towards a toolkit methodology for project managers. *Energy*, 34(5), 564-574.
- Rogerson, C. M. (2012). *Supplier diversity: A new phenomenon in private sector procurement in South Africa*. Paper presented at the Urban Forum.
- Rydin, Y. (2012). *Governing for sustainable urban development*: Earthscan.
- Sneddon, C., Howarth, R. B., & Norgaard, R. B. (2006). Sustainable development in a post-Brundtland world. *Ecological economics*, 57(2), 253-268.
- Sourani, A., & Sohail, M. (2005). Realising social objectives of sustainable construction through procurement strategies.
- Stake, R. E. (2005). Qualitative case studies.
- Suopajärvi, L., Poelzer, G. A., Ejdemo, T., Klyuchnikova, E., Korchak, E., & Nygaard, V. (2016). Social sustainability in northern mining communities: A study of the European North and Northwest Russia. *Resources policy*, 47, 61-68.
- Valdes-Vasquez, R., & Klotz, L. E. (2013). Social sustainability considerations during planning and design: Framework of processes for construction projects. *Journal of Construction Engineering and Management*, 139(1), 10.
- Valenzuela Musura, R., & Albarosa, F. (2017). Social Sustainability Aspects of Agile Project Management: An Exploratory Study of Social Sustainability Aspects in Agile Project Management.
- Vallance, S., Perkins, H. C., & Dixon, J. E. (2011). What is social sustainability? A clarification of concepts. *Geoforum*, 42(3), 342-348.
- Vennström, A., & Erik Eriksson, P. (2010). Client perceived barriers to change of the construction process. *Construction innovation*, 10(2), 126-137.
- Watermeyer, R. (1999). Socio-economic responsibilities: the challenge facing structural engineers. *The Structural Engineer*, 77(17), 22-28.
- Watermeyer, R., Gounden, S., Letchmiah, D., & Shezi, S. (1998). Targeted procurement: a means by which socio-economic objectives can be realized through engineering and construction works contracts: technical paper. *Journal of the South African Institution of Civil Engineering= Joernaal van die Suid-Afrikaanse Instituut van Siviele Ingenieurswese*, 40(4), 15-25.
- Weingaertner, C., & Moberg, Å. (2014). Exploring social sustainability: learning from perspectives on urban development and companies and products. *Sustainable Development*, 22(2), 122-133.
- Whitton, J., Parry, I. M., Akiyoshi, M., & Lawless, W. (2015). Conceptualizing a social sustainability framework for energy infrastructure decisions. *Energy Research & Social Science*, 8, 127-138.
- Yin, R. K. (2013). *Case study research: Design and methods*: Sage publications.

EXPLORING CONFLICTING VIEWS OF TIME IN CONSTRUCTION PROJECTS

D. Boyd and S. Madzima

School of Engineering and the Built Environment, Birmingham City University, Birmingham, UK

Email: david.boyd@bcu.ac.uk

Abstract: Time is central to the delivery of construction projects but it is normally assumed a simple measurable and manageable concept. Yet projects suffer from time overruns, cost overruns and client dissatisfaction. This paper explores the differing views of time on construction projects and analyses how these influence decision-making. The research involved interviews with construction professionals to establish their views and experiences of time focusing on their different experiences and interpretations of time in events. The analysis uses two theoretical distinction: that between Chronos and Kairos and that between linear and cyclical time, to help understand what drives individuals in their decision making. Chronos is the chronological quantitative grounding of time such as hours, days, months, whereas Kairos is the experiential opportuneness of a moment and so exhibits the qualitative aspects that brings meaning to the quantitative time. The discussion established: the domination of Chronos in construction, however, this is experienced differently by different professionals; the strong belief that time can be managed and speeded up and this inducing anxiety because of a formal abhorrence of uncertainty but a reality of time juggling. Thus, successful projects require much richer and dynamic view of time that balances Kairos and Chronos.

Keywords: Construction Projects, Chronos, Decision-Making, Kairos, Uncertainty

1. INTRODUCTION

The construction industry exists to produce buildings and infrastructure for society. The needs and conditions of this production are set within the social, economic, technical and political context of the era. These in particular define what is good and bad about both the finished product and the means of achieving this (Winch 2008). Construction has been seen for a long time as an industry that is unable to deliver to time, cost and quality and for centuries has been told to improve (Fernie et al., 2006). Time is a major area of interest in construction because it an important requirement that must be achieved on construction projects. A considerable amount of literature has been published on the causes of delays in the construction industry whilst considering time management amongst other characterised possible causes. Projects that are managed well in terms of time management from inception through to practical completion have the potential to succeed (Gransberg and Ellicott, 1997).

Although time informs the very fabric of our being, the phenomenology of time is rarely introduced into construction (see Rolfe et al, (2017) for a general review of phenomenology in projects). Phenomenology focuses on how we experience time which is dictated by our internal perceptions and our social and physical context. As this context has changed over the centuries so has our experience of time. For example, following the industrial revolution, life became gradually transformed using a much more organised and detailed view of time, and such ideas as labour time arose which is a commodity to be bought and sold alongside everything else, measured and chronicled by hours, minutes and seconds (Thompson, 1967). The construction industry has existed through these changes and still retains vestiges of past ideas and methods, as well as being influenced by new experiences of time. A much richer notion of time is required. This challenge was initiated by Chan (2012) who not only tried to reconceptualise

time for construction but introduced the idea that it is important to investigate 'the multiple ways that time and temporalities unfold'.

The construction industry is different from other productive sectors because construction projects are temporary, unique, large and built on site (Gould, 2002) therefore time is of essence for realisation of success. The temporary existence of construction projects in their limited time, are faced with various obstacles which may or may not obstruct the smooth function of all project participants depending on how the obstacles are dealt with (Acharya et al. 2004). For temporary undertakings such as construction projects, time handling is very complicated as it appears to be limited and therefore is always running out as a finite resource, limited by contracts and contextual conditions such as weather (Lundin and Soderholm, 1995). One characteristic that is typical of project organisations is their frequent encounter with unexpected events which require spur-of-the-moment solutions (Winch 2011). This makes the experience of time by participants in projects particularly important to the way that they make decisions.

To analyse this more complex understanding of time in projects, in particular the occurrence of unexpected events, this paper will present a review of current perspective on time in projects introducing the concepts of Chronos and Kairos. It uses interviews of professionals involved in projects to determine their experience of managing time and making decisions on construction projects. The findings show that time is not experienced in a simple way, nor even in the same way, by different project participants. This experience is not consistent with the formal measurement and management of time and so causes anxiety. A greater awareness of the kairology, that is the 'appropriate timing of actions in differentiated managerial situations and contexts' (Hedaa and Tornroos, 2002, p31), is required both for project delivery and personal balance.

2. LITERATURE

2.1 Concepts of time

Time is a complicated concept and there is disagreement amongst authors about the dimensions of time and approaches to its use. Conway (2004) argues that individuals' time perceptions are influenced by organisational and social culture. These cultures are defined by a shared view of time which emerges through direct communication between individuals (Conway, 2004). Emotions produce time distortions, for example Ratcliffe (2012) mentions how time slows down and lags behind world time in times of depression or goes faster than world time in happier times (Droit-Volet, 2013). In addition, Vasile (2015) argues the relationship between an individual's perception and psychological function, such as mood, is huge set by the orientation of people through their own space – time environment.

Several writers have also noted that the qualitative analysis of organisational time has been consistently overlooked yet most business processes in organisations rely on individual conceptualisation of time i.e. clock time or event time (Rindell and Iglesias, 2014). In some cases organisational time tends to dilute self-time perceptions due to the increased time pressure on delivery of projects such that opportunities for reflection are almost driven into extinction (Turnbull, 2004).

Clark and Rowlinson (2004) discussed that time has two principles: Chronos and Kairos. Chronos refers to the sequential quantitative measurement of clock time which produces the

ideal of chronological activities. Chronos moves inevitably out from a definite past towards a definite future and it is rigid. On the other hand, Kairos is a qualitative synchronous measure of the right and opportune moment (Clark and Rowlinson, 2004). Because Kairos determines what is appropriate to do or say at a given situation, it goes beyond chronology thereby opening rich opportunities for inspiration. The qualities of Kairos include opportunity, advantage, appropriateness, timeliness among others (Peeples *et al.* 2007). Kairos often deals with things that are of a temporary nature and it is often identified by questions such as when or at what time (Thaler, 2014).

Chronos as a quantitative time perspective is more aligned to the analytical decision making model and, in contrast, Kairos is aligned to the intuitive decision making model (Clark and Rowlinson, 2004). Moreover, it is not possible to plan for Kairos but one has to pay attention to events that attract them to the right moment (Peeples *et al.*, 2007). Otherwise, for many people the utmost potential regret arises from hanging on to a false sense of security instead of grabbing the moment and honoring it for what it is, when it is there.

There are three principles that make Kairos relevant for project management decision making: right time not possible time, critical and instant decision making and lastly, provision of opportunity for extraordinary actions (Thaler, 2014). That is why Müller *et al.* (2009) pointed out that behavioural differences normally indicate that there are more chances to use different decision-making styles in situations. Synchronous decision makers tend to multi-task and they view time as an opportunity provider, a desire and not as an absolute. This has led other authors to refer to Chronos as a strategic aspect which means standing before time and taking time to think and plan for different situations whereas Kairos stands in time and is more aligned to tactical operation (Peeples *et al.* 2007).

Linear time forms the bases of the western society whereby events are neatly segmented in intervals of varying durations thereby imposing some discipline on both the individual and the organisation (Rapport & Overing 2000). Despite the domination of linear time Davies, (1994) established that individuals find it difficult to maintain the strict linear frame of reference. Events follow in a logical order, but they are not controlled by an abstract system, there being no sovereign points of reference to which activities have to conform to precisely (Loy & Goodhew 2005). The aspect of personal identity was investigated by Turnbull (2004) who argued that people are mostly caught between the notion of linear time and cyclical time in search of self-identification; thus, individuals' perceptions of time forms their fundamental attitude and approach to social and organisational existence.

2.2 Time management in construction

Project management in construction is dominated by the notion that it needs to deliver to cost, time and quality with the idea that there is a balance to be struck in their achievement (Winch 2009). Of the many reasons of poor results, time management is ranked amongst the top problem factors. Acharya *et al.* (2004) concluded that time must be made a priority in order to enhance project success. The management of time becomes associated with project planning that lays out tasks within a timeline both to direct progress and to evaluate success. Much literature about time in construction is directed to this planning and the use of network analysis and critical path method (e.g. Vaziri, K, *et al.*, 2007; Hoffman *et al.* 2007). The realities of this are seldom challenged, thus it induces the belief that projects should run to the planned

programme and any deviation from this is an undesired delay. However, Davies (1994) showed that estimation varies in accuracy with the work being undertaken

Delays rarely occur as a result of a single catastrophic event but develop over the course of the process (Acharya et al. 2004). In an analysis of causes of delays in highway construction Ellis and Thomas (2002) concluded that unplanned changes and lack of accountability for timely completion ranked the highest factors.

The procurement route and the contract both limit the ability to manage project time (Eriksson, 2008; China and Hamid, 2015). Contract parameters usually guide professionals taking part in each project phase on the amount of time to spend in performing their roles (Kozlovska et al. 2010). Time is critically important to avoid contractual failure and also cost overruns (Driscoll, 2013). However, Covey (1992) criticised the notion of time management, when it became an obsession of managers through suggesting everyone has an equal amount of time, but instead came up with the idea of self-management of the time given to each and every one.

Managers like to be in control of time. Whipp et al. (2002) introduced the theory of timeliness which they described as the action required by managers in varied managerial situations and contexts. Therefore, timing in decision making is vital because it employs the different dimensions of time. The process of decision making involves selecting an option after consideration of consequences of all options.

3. METHODOLOGY

This research adopted a qualitative approach (Fellows and Liu, 2008) which aimed to elicit and understand people's perceptions and attitude towards time in their decision-making process. This is an exploratory study based on a limited sample but provides important insights into a poorly researched area (Knight and Ruddock, 2008). The research interviews used a narrative approach with dialogue (Boyd 2015) which allowed for a richer exploration of time perceptions. It also solicited detailed insights into the project teams' view of time and how time conceptions influence their decision making based on their feelings, emotions and processes (Flory and Iglesias, 2010). In using the narrative reflection, respondents used past events in making sense of their experience (Flory and Iglesias, 2010).

The questioning order assisted the openness of the interviewees (see Appendix 1). The initial questions eased them into the interview by reflecting on what time meant to them. This showed their reaction to events and issues to do with their role in the construction project. Secondly, there was a question on bad time management in order to focus on the problematic nature of time in current practices of professionals in the industry. Finally, the questions sought to inquire into how time practices impacted on the performance of their colleagues.

In order to get different perspectives on time, interviewees had to be from a variety of backgrounds. Eight respondents were found by the use of the snowball method and from personal contacts (see Appendix 2). These comprised of: two client project managers (PM1 and PM2), one client quantity surveyors (PQS) and one contractor's quantity surveyor (CQS), a contractor's construction managers (CM1), a contractor's senior design manager (SDM), a contractor's planner (CP1) and a site engineer (SE1). These represented a good spread with a focus on site activities as this was considered the most difficult time management situation. They all worked for large companies and had at least 5 years of experience in their roles.

4. FINDINGS

4.1 Different interests in time

The interviewees time interests clearly reflected their roles. The QS were concerned with monthly valuations, claims regarding extensions of time and issuing of certificates of practical completion. A lot of this referred to the time aspects inherent in the contract which set up certain duties and deadlines. Unsurprisingly they connect time to money all the time and these two are intimately connected in their thinking. Project managers were concerned with overall time and identified key involvement at project commencement and practical completion with information management concerns to see that things are happening at the time they expect. The design manager again had a time horizon concentrating at the beginning of the project with issues of information completeness and coherence.

The site engineer however, was absorbed by day to day practice and the way that this was affected by decisions and events. They saw themselves in a battle against time:

part of trying to win that battle is that we have to push for things to happen (SE1).

The planner also saw an overall time frame but, in particular, saw task durations and interdependencies. Their time-artefact is the project programme which they saw as theirs but also saw as the object they must create and recreate. They also have a reporting role about time, both saying where tasks are at in time but also what needs to be done in the future. There were multiple programmes: contract, target and acceleration some of which were public and some private. They also knew that their sub-contractors have different programmes and so are never sure which truth about time is being referred to. There is a lack of trust in others reporting time.

The reference points in all cases were to the programme with a secondary reference to the contract. These define a particular perspective on time and contain/constrain what is needed to be accomplished. The meaning and reality of the programme is a key problem which will be explored in the discussion. The relationship between task and time was always problematic. At a less formal level, these interests also define the anxieties and problems that time gives to the different roles. Thus, the engineer is to some extent in a battle with the programme but also it is something that they use to battle others. This duality of time particularly as it is formalised is that it is a pressure, but at the same time a resource, is key to a richer understanding of time. Thus, the programme is not a definitive document because there are multiple versions of it and these are in a process of constant change.

4.2 The management of time

One aspect of the chronological view of time inherent in the formal system is that it encourages a belief that it is possible to manage time or at least tasks in time. Indeed, issues to do with time are seen as issues to do with time management:

Time in management is fundamentally important in my job. (PM1),

Every morning I write a list of all key task that I have got to achieve that day and focus on those and try not get distracted on other tasks or other emails throughout the day (PM1).

The program is the key feature of time management:

Everything we do is referenced back to the construction program. If the program is telling me an item has to be on site by a certain time, we know that they have got a three month period to manufacture that information, you work back three months to the sign off of design so it gives them that period (DMI).

And even where this is wrong, it has to be taken as correct.

The program duration may not be right but it is a target on which we work towards so for instance if there is an operation meant to take two weeks, we will try and start it on time and aim to finish it on time. (CMI),

for example the tower crane with the wind, we now try and plan that we are not lifting anything during those months of October and November. (CMI).

No one ever thinks whether time durations are appropriate. Thus, one of the key aspects are delays:

a week delay during the tender phase of a project could result in a two to three week delay on delivery of a project (PM1).

Even worse, the chronological view makes people believe that is possible to do things faster:

there is always a faster way and there is always a better way (PQS),

we usually want to do things quicker because if we do them quicker we can make sure we complete our contract with time to spare (SE1).

However, it is recognised that this causes problems:

you are giving people unrealistic deadlines to work towards (PM2).

As seen here, the dominant rhetoric sees time as linear and manageable. This provides an explanation for the focus on delays and the belief that it is possible to drive a project faster. This sets the context for the phenomenological world of time (i.e. how participants experience time) which all participants struggled to articulate but it was evident from the interviews that they had anxieties about time and in particular about future uncertainties.

4.3 Time anxieties and uncertainties

The construction world is full of uncertainties because of aspects such as the ground conditions and weather, the complexities of its processes and the commercially strained business environment. In the discussion, we will reflect on how poorly this is conceptualised and managed.

There are some common uncertainties particularly on site:

we just hit a substructure [during foundation excavation] and if we just dig slightly deeper that will not matter or whether the substructure in that ground is huge therefore no amount of digging will help (CQS),

I was expecting to have new partitions this morning and they did not turn up; it has now given me a problem with the areas of work that they are supposed to be in and the other trades that are working around them have got to be kept busy on other parts (CMI),

when subcontractors haven't got an order, they will tell you what you want to hear, as at the end of the day they want the job 3 months down the line, they would then turn round and start reviewing dates (SPI).

This gets many to admit that there is a problem in planning and the adherence to the programme:

the best laid plan in the world has holes. (CQS 1),

my role is 60% firefighting so it is hard to plan out the day (CMI),

You cannot always get things right, not in this industry, sometimes you come with your day planned and for some reason that does not happen because suddenly something has come up that is more critical and everything you thought you would do that day, you end up doing sometime else (SPI).

These uncertainties and the difficulty of dealing with them induce anxiety. Even on normal work the thought of the uncertainties induces anxiety:

say we need bricks on site for a particular date and it takes ten weeks to get the bricks here and you need to order the bricks four weeks before so it is going to take 14 weeks in total to get the bricks on site. So every week you do not place the order is every week you do not get the bricks so you plan your time management around that you are going to procure them in time. Say something else came up on site that is more urgent than having the bricks in 14 weeks' time then you have to make a decision to work out things on site which obviously puts your plans out of sync. (CQS).

They will admit that the drive of the programme and belief in doing it faster causes problems:

usually everything is done quicker, faster but it is not usually the best way to do it. It puts pressure on the team sometimes pressure is good but too much pressure is not good because it is unrealistic, you won't get your documents to a good level (PM2),

There is always pressure to impact design program when things are not working as well as they are supposed to on site, decisions are made without being thought about and it might seem as the right thing to do at time but it will come back and hound you because you have not really worked it through, (DM1),

It obviously takes time to do the stage check and move forward with it and if you have only got a narrow window in which you have to make procurement done, sometimes you just have to make the decision to go with the subcontractor with the competitive role and what you have based your decision on. (CQS),

it is critical to find a fine balance between pushing a program and doing things right (CQS).

Interestingly, the idea of working together surfaces from this anxiety but this takes time:

work collaboratively trying to build those relationships and that in itself takes time. (PM2),

people in the office might have deadlines they need to hit so they would ask me to do something on their projects in order to facilitate them hit their deadlines (PQS).

But the bottom line about time is that:

It is never enough (SE1),

and people use their own time:

Often it results in doing overtime or coming in over the weekend to get something done by Monday morning (PQS)

5. DISCUSSION

The research investigated the personal perceptions of time of different professionals in construction projects. The findings reveal that different professional roles experience time differently, that there is a strong belief that time can be managed and controlled to do things faster thus creating delay as a problem, and finally this conception of time induces anxiety set by a formal abhorrence of uncertainty but in a reality of time juggling. It is the latter finding which will be explored in more detail. The way that these are conceptualised and managed in current construction projects is also considered as problematic and this is addressed.

As was shown, the participants struggled to articulate their problems with time other than their desire to work to the programme. This obvious finding then is that construction has become concerned obsessively with the chronological view of time to an extent that everyone is perturbed by any mishaps to the construction programme or the design programme. The programme assumes largely a linear arrangement, therefore, the Chronos and linear time elements prove to be the more prevalent. The programme is an interesting representation of the order and duration of tasks that take place within time. The simplification of the world, that it represents, allows it to be used as a tool; however, the assumptions behind it and the consequences of it are not understood by participants and so are seldom challenged. The programme is not just used as a tool to help people understand the relationship of tasks in time but it is an ideal that is used to drive tasks. The problem with such ideals are that they cope badly with things not going to plan; these are seen as sinful and insinuate against the character of the people involved (see Weber (1905/2003) on the religious basis of strict time discipline and its embedding in the protestant work ethic). What the programme does not deal with are the uncertainties with these being separated off into risk analysis or sensitivity analyses (although Monte Carlo simulations have been added to programmes e.g. Kwak and Ingall (2009) but these are not currently used in practice). Winch (2011) in his critique of lean construction redefines construction project management as the production of projects rather than the planned flow as presented by lean. He does this to emphasise that managing projects is fundamentally about managing risk and uncertainty. In this, he sees information exchange

as critical; we would agree but see information exchange as an understanding between people with different experiences of time.

However, of most importance is that the programme does not represent the different experiences of time of the various roles associated with the tasks. Chan (2015) suggests that “Rational methods need to be supplemented by an appreciation of how individuals scale their time in organisations and how this subsequently shapes the rhythm and pace of organisational practices”. This is exactly what is missing in the programme and is needed to more effectively acknowledge uncertainty. Essential to this exercise is the use of the concept of Kairos. This focusses on the right instant for doing something; thus, identifies events as important in social and individual experience. In these events, the emotional position needs to be recognised; in that sense, anxiety can be useful for undertaking a task but also problematic depending on the coincidence of other events. Thus the ‘timescape’ (Keenoy et al, 2002) of the project becomes what is managed. This is an emotional environment that indicates the most favourable time to undertake tasks. It is having an understanding of the course of events and stressors which make a particular time a good time to undertake challenging tasks. This, of course, moves away from the Chronos’s programme time which sees the sequences of activities as essential to be performed. However, the result from this Chronos view are poor conditions for undertaking stressful tasks, with differing anxieties about failure from within the team which can induce: avoidance, non-cooperation and blame. Thus, Chronos induces this failure and ‘loses time’, both because of this, and because of the destroyed relationships to recover the project.

A solution is offered by Hedaa and Tornroos (2015) who introduce the idea of Kairology to “denote a theory of timing (coinciding events) under conditions of uncertainty”. This does not reject Chronos but balances it with Kairos. As Hedaa and Tornross (2015) state “Seeing the future possibilities and the impact of surprises as an opportunity structure for corporate performance leads to a focus on flexibility and rapid reaction rather than a focus on being big and powerful”. It does not stop achieving buildings in time or not having this as important but it places this in a more realistic world that prevents the unrealities from being hidden and the positive opportunities of working together being delivered in a lower anxiety environment.

6. CONCLUSION

This research confirmed that time management in construction is dictated by the chronological, linear time driver of the project programme. This Chronos view is limiting and induces failure; the fear of which induces anxiety in project participants. Kairos on the other hand helps construction personnel act in the present acknowledging unplanned events. Kairos gives meaning to Chronos time. It revealed that different professionals experience time differently, that there is a strong belief that time can be managed and controlled to do things faster thus creating delay as a problem, and finally this conception of time induces anxiety set by a formal abhorrence of uncertainty but a reality of time juggling. Although from a limited sample, the analysis of time undertaken in this paper has extended knowledge of the different dimensions of time that influences different decisions and reactions in construction projects and other spheres of life. The study has raised important questions about the nature of the demands of organisational time on individuals which was found to be so dominant that it encroached on the ability of respondents to distinguish their personal views from those of the organisation. It was concluded that clients, project managers and project professionals need a much richer and dynamic view of time that balances Kairos and Chronos to deliver better management of projects such as presented by Hedaa and Tornroos’s (2015).

7. REFERENCES

- Acharya et al. (2004). Factors affecting timely completion of construction projects, Proceedings of the Fifth Asia Pacific Industrial Engineering and Management Systems Conference.
- Boyd, D. (2013), Using events to connect thinking and doing in knowledge management, *Construction Management and Economics* Vol. 31 , Iss. 11.
- Chan P.W. (2012) Constructing a sense of time in projects: implications of a Bergsonian view of time In: Smith, S.D (Ed) Procs 28th Annual ARCOM Conference, 3-5 September 2012, Edinburgh, UK, Association of Researchers in Construction Management, 497-507.
- China, L. S and Hamida, A. R. A. (2015). The practice of time management on construction project, *Procedia Engineering*, Vol 125, 32 – 39
- Clark, P. and Rowlinson. M. (2004), “The Treatment of History in Organisation Studies: Towards an ‘Historic Turn’?” *Business History*, 46(3), 331-352.
- Conway L.G. (2004). Social contagion of time perception, *Journal of Experimental Social Psychology*, Vol 40, 113 – 120.
- Covey, S. (1992), *Principle-Centred Leadership*, London, Simon and Schuster.
- Davies, G., (1994). What Should Time Be?, *European Journal of Marketing*, Vol. 28 (8/9) 100 – 113.
- Driscoll, T. J. (2013). Managing the Time Factor, *Construction Claims*, <http://www.constructionadvisoryreport.com/home/blog/2013/09/11/managing-the-time-factor/>. Accessed 10/08/2016.
- Droit-Volet, S. (2013). Time perception, emotions and mood disorders, *Journal of Psychology*, Vol 107, 255 – 264
- Ellis R.C. and Thomas, H.R. (2002) The Root Causes of Delays in Highway Construction. Paper Presented at the 82nd Meeting of the Transportation Research Board, Washington, DC.
- Eriksson, P.E. (2008), Procurement effects on competition in client-contractor relationships, *Journal of Construction Engineering and Management*, Vol 134 No. 2, pp. 103-111.
- Fellows, R and Liu, A. (2008) *Research methods for construction*, 3rd Ed, Sussex, Blackwell
- Fernie, S., Leiringer, R. and Thorpe, T. (2006) Rethinking change in construction: a critical perspective, *Building Research and Information*, Vol. 34, No.2, pp. 91-103
- Flory, M. and Iglesias, O.,(2010) "Once upon a time: The role of rhetoric and narratives in management research and practice", *Journal of Organizational Change Management*, Vol. 23 Issue: 2, pp.113-119
- Gould, F. E. (2002). *Managing the Construction Process*, 2nd Ed, Prentice Hall.
- Gransberg, D.D. and Ellicott, M.A., (1997), “Best Value Contracting Criteria” *Cost Engineering*, *Journal of AACE, International*, Vol. 39, (6), June, 1997, pp. 31-34.
- Hedaa, L., & Törnroos, J. -A. (2002). Towards a Theory of Timing: Kairology in Business Networks. In R. Whipp, B. Adams and I. Stabelis (Eds), *Making Time. Time and Management in Modern Organizations*, (pp. 31–45). Oxford, Oxford University Press.
- Hoffman, G. J., Thal Jr., A. E., Webb, T. S. and Weir, J. D. (2007) Estimating performance time in construction projects. *Journal of Management in Engineering*, 23(4), 193-199.
- Keenoy, T., Oswick, C., Anthony, P.D., Grant, D. and Mangham, I.L. (2002) ‘Interpretive Times: The Timescape of Decision-Making’, Chapter 13 in Whipp, R., Adam, B. and Sabelis, I. (eds.) *Making Time*, Oxford: Oxford University Press, pp.183-195.
- Knight, A and Ruddock, L. (2008). *Advanced research methods in the built environment*, Sussex, Wiley-Blackwell
- Kozlovska et al. (2010). Access to construction time objectiveness, *International Journal of Organization, Technology and Management in Construction*, Vol 2(2), 200 – 206.
- Kwak and Ingall (2009), Exploring Monte Carlo Simulation Applications for Project management, *IEEE Engineering Management Review*, 37(2)
- Loy, David, and Goodhew, Linda, 2005, “Consuming Time”, in, Kaza, Stephanie ed., *Hooked: Buddhist Writings On Greed, Desire, and the Urge to Consume*, Shambala, Boston
- Lundin, R. A. and Soderholm, A. (1995). A theory of the temporary organization, *Scandinavian Journal of Management*, Vol 11 (4), 437 – 455.
- Müller et al. (2009). Cultural differences in decision making in project teams, *International Journal of Managing Projects in Business*, Vol 2 (1), 70 – 93.
- Peebles, T., Rosinski, P., & Strickland, M., (2007), Chronos and Kairos: strategies and tactics: the case of constructing Elon University’s professional writing and rhetoric concentration, *Composition Studies*, Volume 35, Number 1, Spring
- Rapport, N., Overing, J. (2000), *Social and Cultural Anthropology: The Key Concepts*, London: Routledge.
- Rindell, A and Iglesias, O. (2014), Context and time in brand image constructions, *Journal of Organizational Change Management*, Vol 27 (5), 756 – 768.

Rolfe, B., Segal, S. and Cicmil, S. (2017) The wisdom of conversations: Existential Hermeneutic Phenomenology (EHP) for project managers. *International Journal of Project Management*, 35 (5). pp. 739-748

Thaler, M. (2014). On Time in Just War Theory: From Chronos to Kairos. *Polity*, 46(4), 520-546.

Thompson, E. P.,(1967), Time, Work-Discipline, and Industrial Capitalism, Past & Present, No. 38, pp. 56-97

Turnbull, S. (2004). Perceptions and experience of time-space compression and acceleration, *Journal of Managerial Psychology*, Vol 19 (8), 809 – 824

Vasile, C. (2015). Time perception, cognitive correlates, age and emotions, *Procedia - Social and Behavioral Sciences*, Vol 187, 695 – 699.

Vaziri, K, Carr, P G and Nozick, L K (2007) Project Planning for Construction under Uncertainty with Limited Resources. *Journal of Construction Engineering and Management*, 133(4), 268–76.

Weber, M.,(1905/2003) *The Protestant Work Ethic and the Spirit of Capitalism*, Dover Publications

Winch, G. M. (2008) *Revaluating Construction: Implications for the Construction Process*, in *Clients Driving Innovation* (eds P. Brandon and S.-L. Lu), Wiley-Blackwell, Oxford, UK.

Winch, G. M. (2009) *Managing Construction Projects: An Information Processing Approach*

Winch G. (2011). Towards a theory of construction as production by projects, *Building Research & Information* Vol. 34(2)

Whipp, R., Adams, B. and Stabelis, I.(Eds), *Making Time. Time and Management in Modern Organizations*, Oxford, Oxford University Press.

8. APPENDIX 1.

Interview questions

1. What is your role in construction and can you explain where in the project phases it is most active?
2. What is your view of time and how does it influence your decision making?
3. What challenges do you face in implementing time management? Give an example.
4. Have you experienced any bad time management in your job role?
5. How did bad time management affect your decision making?
6. How did your actions affect your colleagues' execution of their roles and the project timeline? What were their views?

9. APPENDIX 2

List of interviewees with their job titles, roles and responsibilities

Job title	Roles and responsibilities
Project manager 1 (client) (PM1)	Works with developers in delivering projects, tendering projects and is involved in the selection of a contractor. Acts as a middle person between client and contractor. Mostly active during pre- contract as well as post construction.
Project manager 2 (client) (PM2)	Works with developers in delivering projects, procurement, tendering projects and is involved in the selection of a contractor. Acts as a middle person between client and contractor. Mostly active during pre- contract as well as post construction.
Construction manager (contractor) (CM1)	Responsible for all site works and site production including site build. In charge of all contractors and site management personnel.
Site Engineer/ manager (CM2)	Set up of site controls and all temporary works mostly active post-contract. He is a link between designers and site managers and helps interpret the design information on site.
Senior design manager (SDM)	Heads the design delivery team, making sure design information is delivered on time for procurement.

	Heavily involved at the front-end of the project
Quantity surveyor 1 (client) (PQS)	In charge of construction finances as well as contract administration. Mostly active post-contract but has some involvement pre-contract.
Quantity surveyor 2 (contractor) (CQS)	In charge of construction finances as well as contract administration. Mostly active post-contract but has some involvement pre-contract.
Site Planner (contractor) (CP1)	Programme management with 12 years' experience. Mainly active post contract.

SHAPING FUTURE CONSTRUCTION-RELATED BUSINESS MANAGEMENT: A REVIEW OF 77 CONCEPTS

P. Huovinen

Department of Civil Engineering, Tampere University of Technology, P.O. Box 600, FI-33101, Finland

Email: pekka.huovinen@tut.fi

Abstract: The aim of this paper is to shape the validity of construction-related business management (BM) concepts and the effectiveness of BM practices within firms competing in construction markets. This shaping is based on the outcomes of the 17-year reviewing process, i.e., 77 construction-related BM concepts published during the years 1990-2016, primarily via 15 journals related to management in construction. Consequently, it is suggested that researchers shape future studies on highly valid BM concepts and highly effective BM practices, reject one-way applications of generic BM knowledge to construction-related contexts, take a proper distance from the eight schools of thought on generic BM, collaborate with business managers, and innovate construction-related, high-validity BM concepts. In turn, business managers could shape insights in contextual differences in construction markets, alertness to find means for dealing with deep uncertainty, such as using experts, own judgement, wisdom from crowds, and foresights to co-produce contextual BM knowledge together with key researchers. Thus, this pioneering review serves as a response to Leiringer and Dainty's (2017) editorial and the launching of a new section of state-of-the-art reviews of research on management in construction where published knowledge about sub-fields, one of them being construction-related BM, is analyzed and new perspectives are provided through syntheses.

Keywords: Applied Research, Business Management, Construction, Literature Review, Real Estate.

1. INTRODUCTION

The modern world is becoming connected and competition is being transformed by smart offerings. Companies are forced to find novel responses to key questions, such as “What businesses are we in?” and “How to set and attain business-level goals?” Especially business managers are facing new choices about how to manage value, how to collaborate, and how to secure advantages as smart offerings and new capabilities reshape business boundaries. Smart, connected offerings are freeing stakeholders to purchase only relevant offerings and to get more out of those offerings that they purchase, in part through offering sharing. New units focused on data management, smart offering development, and customer success management are starting to appear (Porter and Heppelmann, 2014 and 2015). In turn, *managing a single business (un)successfully* is herein seen as the most significant area of the expanding total domain of strategic management.

Today the field of strategic management is being criticized in terms of fragmentation, preference for novelty, lack of rigorous theory building, unwillingness to document and report empirical facts, inability to subject its many espoused theories to systematic empirical testing, and limited guidance that it provides to business managers. Consequently, many scholars are calling for a period of consolidation, integration, and redirection (Durand et al., 2017). In turn, it is herein posited that *business management (BM) research* is one of the most important areas within strategic management research.

Multiple significant business contexts are embedded within *construction markets*, including the contracting, design, construction, servicing, project-based, and life-cycle aspects of capital investments in natural resources usage, energy supply, telecommunications, transportation, infrastructure, manufacturing, general building, and other real estate concerns. Along the temporal dimension, these markets broadly integrate stocks of existing built assets, annual changes within these stocks through sales, new construction and renovation as well as continuous management, operations, and maintenance of such assets. Thus, the term construction markets covers herein also built environments, capital investment markets, and real estate sectors across the globe.

In turn, this paper deals with applied, theoretical, and contextual knowledge on *construction-related BM*. Managers and researchers alike aim at advancing highly applicable BM concepts and highly effective BM practices with focal contexts in construction. The conceptualization involves the setting and attainment of business goals, business ideation coupled with competitive strategizing, business process re-engineering, competitiveness development including smart offerings, the framing of business units as well as collaboration with stakeholders. The two-fold aim of the paper is to shape the validity of construction-related BM concepts and the effectiveness of BM practices within firms competing in construction markets. The aim is being attained via the eight steps as follows. Step 1 re-informs about the method of the conceptual review and the conduct of the 17-year reviewing process. Steps 2-7 include the reporting on the identified population of 77 construction-related BM concepts published during the years 1990-2016. Step 8 combines a discussion and conclusions on the dual shaping.

2. METHOD OF THE REVIEW OF CONSTRUCTION-RELATED BM RESEARCH

How rigorously has this review of construction-related BM concepts been conducted (Step 1)? The reviewing process was pioneered in the year 1999. The five review rounds have been conducted in the years 1999-2003, 2006, 2010-2012, 2014, and 2017. The past outcomes have been reported at many CIB-related conferences, such as in Toronto (Huovinen, 2004), Bahamas (Huovinen, 2006a), Rome (Huovinen, 2006b), Salford (Huovinen, 2010), London (Huovinen, 2015a), and Tampere (Huovinen, 2015b and 2016). This independent review investigates concepts in a targeted area, i.e., construction-related BM. The unit of review is a concept, which an author has designed for managing a business with a context embedded within construction markets and which this author has published in English via one of formal channels. Overall, the *17-year reviewing process aims* at (a) revealing a variety of BM approaches, (b) citing and discussing landmark concepts with(out) empirical evidence, (c) stating conclusions on research and concepts, (d) showing gaps, (e) pointing out to ways of closing such gaps, and (f) reaching recommendations (applying Hart, 1998).

The *six original limitations* of this review are as follows. (i) A reviewer should include all eligible units at the outset. Exclusion may be appropriate only when rules are defined *ex ante* and a number of concepts is large enough for substantiating conclusions (Cooper, 1998). Thus, the four relevance rules, the 14 elimination rules, and the five inclusion rules were specified in the year 1999 (Huovinen, 2003 and 2008). (ii) The assessment of causalities built inside BM concepts is excluded because only primary source-generated evidence based on experimental research allows one to make statements concerning causality (Cooper, 1998). Herein, only the existence of relations is recognized. (iii) A reviewer cannot judge objects, i.e., if one were to judge one would be making a commitment to one methodological position (Hart, 1998). Accordingly, the review of qualitative research methods is excluded. Only the types of

empirical evidence are recognized. (iv) Conceptual studies cannot be verified as long as researchers neither clearly report on methodologies, nor have conventions for verification (Miles and Huberman, 1994). When this is still the current state of focal research, the assessment of reporting is excluded. (v) The coherent nature of BM is maintained by focusing on research on firms based in the OECD countries, except that Singapore and Hong Kong are included due to these authors' British Commonwealth heritage and interests in global construction. (vi) Concepts are abstractions representing phenomena, herein BM (Ghauri and Grønhaug, 2002). An author must answer the question "What is a way of managing a business that enables managers to set challenging goals and attain them?" A population consists of (a) BM concepts that are directly related to business goals management, (b) BM concepts that are only indirectly or implicitly related to business goals, (c) competitiveness management concepts that enable performance and business goals attainment, and (d) competitiveness management concepts that are only indirectly or implicitly related to goals.

Hart's (1998) handbook on reviewing qualitative and conceptual research has been relied upon. The replicable, handbook-based, and invented-here ways for searching, browsing, in-/excluding, retrieving, coding, exposing, describing, analyzing, and interfering with conceptual BM knowledge have been documented, used, and reported upon in Huovinen (2003, 2006b, 2008, and 2010) to make this reviewing process open to criticism and debate.

The degrees of search comprehensiveness have varied markedly concerning the seven channels of publishing (see 1a, ..., 4a in Table 1). Only the 1990-2016 volumes of 23 journals related to CM have been browsed completely. No pre-limiting search words have been used. A hands-on search has implied the reading of thousands of lists of contents, titles, and abstracts as well as the browsing of hundreds of texts. So far, the review has resulted in the identification of 77 construction-related BM concepts published during the years 1990-2016. Thereof, 40 (52%) concepts have been published via 15 journals (Table 1 and Table 2).

Table 1: Publishing of 74 references containing 77 construction-related BM concepts via the seven channels (1a, ..., 4a) during the years 1990-2016.

Channel of publishing	Comprehensiveness of search rounds	No. of references		No. of concepts	
		No.	(%)	No.	(%)
1a Construction-related books and reports	1990-2002: 9 publishers 2003-2016: Selectively	6*	(8%)	9	(12%)
1b Other management books and reports	1990-2002: 18 publishers 2003-2016: Selectively	1	(1%)	1	(1%)
2a Chapters in edited, construction-related books and reports	1990-2002: 9 publishers 2003-2016: Selectively	3	(4%)	3	(4%)
2b Chapters in other edited books and reports	1990-2002: 9 publishers 2003-2016: Selectively	1	(1%)	1	(1%)
3a Construction-related journals	1990-2005: 25 journals 1990-2016: 23 journals	41#	(55%)	40	(52%)
3b Other journals in business administration	1990-2013: 42-45 journals 2014-2016: No search (yet)	8□	(11%)	9	(12%)
4a Construction-related conference proceedings	1990-2005: 22 conferences 2006-2016: Selectively	14	(19%)	14	(18%)
4b Other proceedings	No search	0	(0%)	0	(0%)
5a Construction-related databases	No search	0	(0%)	0	(0%)
5b Other databases	No search	0	(0%)	0	(0%)

Sum	-	74 (100%)	77 (100%)
-----	---	-----------	-----------

Key: * One book contains 4 concepts. # One concept is published via 2 articles and one report and one article are related to the same concept. □ One article contains 2 concepts.

Table 2: Publishing of 41 articles via 15 (out of 23 browsed) construction-related journals during the years 1990-2016, containing 40 construction-related BM concepts (1 concept has been published via 2 articles).

Journal, volumes published between 1990-2016 or 1st year- Publisher (during the browsing in April 2017)	Articles No. (%)
Construction Management and Economics, vol. 8-34 Taylor & Francis Group, Routledge	10 (24.4%)
International Journal of Project Management, vol. 8-34 Elsevier Ltd, IPMA, APM	5 (12.2%)
Journal of Corporate Real Estate, vol. 1-18 1999- Emerald Group Publishing	4 (9.8%)
Journal of Management in Engineering, vol. 6-32 ASCE	4 (9.8%)
Journal of Facilities Management, vol. 1-14 2002- Emerald Group Publishing	3 (7.3%)
Journal of Real Estate Research, vol. 5-38 ARES	3 (7.3%)
Project Management Journal, vol. 21-47 PMI and Wiley	3 (7.3%)
Engineering, Construction and Architectural Management, vol. 1-23 1994- Emerald Group Publishing	2 (4.9%)
Building Research & Information, vol. 18-44 Taylor & Francis Group, Routledge	1 (2.4%)
Construction Innovation, vol. 1-16 2001- Emerald Group Publishing	1 (2.4%)
Facilities, vol. 8-33 Emerald Group Publishing	1 (2.4%)
Journal of Construction Engineering and Management, vol. 116-142 ASCE	1 (2.4%)
Leadership and Management in Engineering, vol. 1-13 2001-2013 ASCE	1 (2.4%)
PM Network, vol. 4-30 PMI	1 (2.4%)
Project Perspectives, vol. XXVII-XXXVI 2004-2014 (PM vol. 1-9 1995-2003) Project Management Association Finland and IPMA	1 (2.4%)
Cost Engineering, vol. 32-58 AACE International	0 (0.0%)
Engineering Management, IEEE Transactions on, vol. 37-63 IEEE Technology Management Council	0 (0.0%)
Engineering Project Organization Journal, vol. 1-6 2011- Taylor & Francis Group and EPOS	0 (0.0%)
International Journal of Managing Projects in Business, vol. 1-9 2008- Emerald Group Publishing	0 (0.0%)
International Journal of Project Organisation and Management, vol. 1-8 2008- Inderscience Enterprises Ltd	0 (0.0%)
ITcon, Electronic Journal of IT in Construction, vol. 1-21 1996- CIB	0 (0.0%)
Journal of Real Estate Portfolio Management, vol. 1-22 1995- ARES	0 (0.0%)

Property Management, vol. 8-34 Emerald Group Publishing	0 (0.0%)
Sum	41 (100.0%)

The validity of this review has been protected through problem formulation, trade-offs in aims setting versus originality and review planning, comprehensive search for references, analytical reading and evaluation, BM concept analysis, and reporting (adopting Cooper, 1998; Huovinen, 2003, 2008, and 2016). In particular, a *concept author-reviewer bias* has been handled as follows. This reviewer has designed 13% or 10 out of 77 construction-related BM concepts. He is a member of the third, competence-based school of thought on generic BM. However, he has designed 3 organization-based, 3 dynamism-based, 2 Porterian, 1 knowledge-based, and only 1 competence-based concept. Two (out of 3) organization-based BM concepts have been co-designed. Future reviewers can test the inter-concept consistency of this reviewer's assessments in the case of his 10 concepts (the publications containing these assessments will be submitted on request). Instead, this reviewing process has been protected only in part against a *formal publication channel bias*, i.e., a difference between 77 identified BM concepts and a true population over the 27-year period of publishing. Today the latter may consist of 90-95 BM concepts. Thus, more channels should be covered, beginning with the 2014-2016 volumes of 47 journals in business administration.

3. OVERVIEW OF 77 CONSTRUCTION-RELATED BM CONCEPTS PUBLISHED DURING THE YEARS 1990-2016

What is the relatedness of 77 construction-related BM concepts to the schools of thought on generic BM (Step 2)? Each BM concept has been assigned to one school based on the author's rationale and reply to the question "What is the primary way (element) of managing that enables managers to set challenging business goals and also to attain them?" Moreover, every concept has its primary theoretical roots in one school. The combined share of 19 dynamism-based concepts, 17 Porterian concepts, 15 organization-based concepts, and 11 knowledge-based concepts is 81% (Table 3). None of the schools has triggered a coherent flow of construction-related BM concepts. The temporal pattern of the conceptualization of this contextual BM knowledge is emerging and the content pattern is fragmented.

Table 3: Relatedness of 77 construction-related BM concepts (published during the years 1990-2016) to the eight schools of thought on generic BM, by the three publishing periods.

School of thought on generic business management (BM)	BM concepts published in 1990-2002 (13 years)		BM concepts published in 2003-2009 (7 years)		BM concepts published in 2010-2016 (7 years)		All BM concepts published in 1990-2016 (27 years)	
	No.	(%)	No.	(%)	No.	(%)	No.	(%)
1 Porterian school	11	(29%)	4	(15%)	2	(15%)	17	(22%)
2 Resource-based school	1	(3%)	0	(0%)	1	(8%)	2	(3%)
3 Competence-based school	3	(8%)	2	(8%)	0	(0%)	5	(6%)
4 Knowledge-based school	7	(18%)	3	(12%)	1	(8%)	11	(14%)
5 Organization-based school	9	(24%)	5	(19%)	1	(8%)	15	(19%)
6 Process-based school	0	(0%)	7	(27%)	1	(8%)	8	(10%)
7 Dynamism-based school	7	(18%)	5	(19%)	7	(54%)	19	(25%)

8 Evolutionary school	0 (0%)	0 (0%)	0 (0%)	0 (0%)
Sum	38 (100%)	26 (100%)	13 (100%)	77 (100%)

What is the relatedness of 77 construction-related BM concepts to applied disciplines (Step 3)? The bulk of this applied, contextual BM knowledge has been conceptualized by the authors who belong to four disciplines in engineering sciences, i.e., 36 (47%) BM concepts are related to CM, 16 (21%) BM concepts are related to industrial management and international marketing, 13 (17%) BM concepts are related to corporate real estate services, and 12 (16%) BM concepts are related to PM. Only 10 (13%) BM concepts have been designed by the authors affiliated to business schools. So far, no construction-related BM research traditions, programs, or groups have been sustained inside the OECD countries.

For what business contexts have the authors designed 77 construction-related BM concepts, respectively (Step 4)? 26 (34%) concepts have been designed for construction or building, 25 (32%) concepts for project-based business, contracting, complex product systems, or engineering, purchasing, and construction (EPC) projects, 12 (16%) concepts for real estate development and services, 6 (8%) concepts for design and consulting services, 5 (6%) concepts for capital investments-based businesses, and 3 (4%) concepts for building products.

What are the home base contexts, the domestic market contexts, or the foreign target market contexts of focal firms for which the authors have designed 77 construction-related BM concepts, respectively (Step 5)? In total, the authors have specified 78 such geographically bounded contexts. There are 26 (33%) worldwide or global contexts, 16 (21%) UK contexts, 12 (15%) US contexts, 7 (9%) Finland-based contexts, 5 (6%) Swedish contexts, 3 (4%) generic contexts, 2 (3%) Australian contexts, 2 (3%) Dutch contexts, 2 (3%) Swiss contexts, 1 (1%) German context, 1 (1%) Irish context, and 1 (1%) Hong Kong –based context.

What are the levels of applied theoretical advancement among 77 construction-related BM concepts (Step 6)? As expected, no high-level or high-novelty BM concepts have been designed. Each of 77 authors has adopted one or more generic BM concepts and/or one or more international business (IB) management concepts (with contexts outside construction) as a theoretical basis for accommodating a focal construction-related context. Thereof, 32 (42%) authors have incorporated one or more applied, contextual elements into their concepts for managing businesses in focal construction-related contexts, respectively. 45 (58%) remaining authors have applied the generic BM concepts or the IB management concepts without adding or changing any elements, respectively (Table 4). It seems that these study designs correspond to the ones that most researchers in CM are drawing upon, i.e., models, maps, narratives, and classification schemes, originating to large extents from within mainstream management thinking and research (Bresnen, 2017).

Table 4: Thirty-two construction-related BM concepts (published during the years 1990-2016) designed with elements for focal contexts embedded within construction markets.

School of thought on BM	Concepts without elements designed for focal contexts		Concepts with elements designed for focal contexts		All construction-related BM concepts	
	No.	(%)	No.	(%)	No.	(%)
1 Porterian School	6	(35%)	11	(65%)	17	(100%)
2 Resource-Based School	1	(50%)	1	(50%)	2	(100%)
3 Competence-Based School	2	(40%)	3	(60%)	5	(100%)

4 Knowledge-Based School	9 (82%)	2 (18%)	11 (100%)
5 Organization-Based School	10 (67%)	5 (33%)	15 (100%)
6 Process-Based School	6 (75%)	2 (25%)	8 (100%)
7 Dynamism-Based School	11 (58%)	8 (42%)	19 (100%)
8 Evolutionary School	0 (0%)	0 (0%)	0 (0%)
Sum	45 (58%)	32 (42%)	77 (100%)

What are the degrees of practical applicability among 77 construction-related BM concepts (Step 7)? It seems that these degrees are quite low on average. Only those 32 (42%) BM concepts contain context-specific elements to accommodate business type-specific and other characteristics. In turn, only 21 (27%) BM concepts have been designed along the international dimension to correspond to the managing of aspects of an IB based on construction markets (Table 5).

Table 5: Twenty-one construction-related BM concepts (published during the years 1990-2016) designed along the international dimension.

School of thought on BM	BM concepts designed along the international dimension		BM concepts designed without the international dimension		All BM concepts	
	No.	(%)	No.	(%)	No.	(%)
1 Porterian school	6	(35%)	11	(65%)	17	(100%)
2 Resource-based school	1	(50%)	1	(50%)	2	(100%)
3 Competence-based school	1	(20%)	4	(80%)	5	(100%)
4 Knowledge-based school	2	(18%)	9	(82%)	11	(100%)
5 Organization-based school	2	(13%)	13	(87%)	15	(100%)
6 Process-based school	2	(25%)	6	(75%)	8	(100%)
7 Dynamism-based school	7	(37%)	12	(63%)	19	(100%)
8 Evolutionary school	0	(0%)	0	(0%)	0	(0%)
Sum	21	(27%)	56	(73%)	77	(100%)

Only 38 (49%) BM concepts are supported with *empirical, case-based evidence* on possible positive causal relationships between the adoption of focal BM concepts and case companies managing their focal businesses highly successfully in targeted contexts, respectively.

Moreover, the element-specific reviewing has revealed *severe biases in BM concept designs*. Namely, many authors have synthesized their concepts for managing IBs in construction markets by theorizing from cases and interviews. However, some of these authors have not designed any elements along a focal international dimension. It is evident that the negligence of this embedded IB domain has destroyed the practical relevance of these BM concepts.

4. DISCUSSION AND CONCLUSIONS

The dual shaping of construction-related BM concepts and practices in the future is herein dealt with as follows.

How to shape validity of construction-related BM concepts in the future (Step 8.1)? It is herein suggested that *construction-related BM researchers* (i) aim at theoretical developments and empirical analyses that subsume and integrate multiple theoretical streams, (ii) adopt different generic BM concepts to address the same areas of construction-related BM, (iii) develop single models, even narrow-range theories, and apply them to a range of separate but related phenomena, such as business types based on construction markets, (iv) develop new concepts to address construction-related BM phenomena, and (v) define BM concepts clearly, state assumptions explicitly, and logically derive causal relationships to support cohesive empirical progress (aligning with Durand et al., 2017).

This review has revealed that all the designers (authors) of 77 construction-related BM concepts have adopted generic BM and/or IB management perspectives, respectively. In other words, they have selected these concepts and research methods from within the eight schools of thought on generic BM and simply applied them to multiple contexts embedded within international and domestic construction markets, respectively. Especially, *justifications and relevance from the eight schools of thought should not be automatically inherited*. Instead, construction-related BM researchers should aim at theoretically novel conceptualizations. This more innovative behavior could be triggered by launching thorough discussions on the role of construction-related BM research, R&D&I methods to be used, and criteria to be set for the designs of future applied studies and concepts (aligning with Koskela, 2017). Indeed, some distancing from the eight schools of thought on generic BM would give a number of future opportunities, such as greater cross-fertilization of ideas and concepts between construction-related and generic BM/IB researchers (aligning with Bresnen, 2017).

Construction-related BM researchers and business managers should co-set aims in order to craft 10-15 first-ever contextual concepts for managing major businesses in construction, such as housing renovation contracting, housing development, real estate development, technology-intensive engineering and design services, and prefabricated building systems and products businesses. For this purpose, future researchers need to build ‘pre-understanding’ up to levels that enable them, in each case, to define a rationale and make purposeful choices concerning business types, semi-applications of generic BM concepts, and the design of semi-novel construction-related BM concepts.

How to shape effectiveness of BM practices within firms competing in construction markets in the future (Step 8.2)? The modern, built world is becoming more accessible, but also more diverse. When various stakeholders launch cross-border operations, local contexts are complemented with international or even global contexts connecting multiple countries. Construction-related BM will be more and more about understanding, incorporating, and exploiting contexts and contextual differences (aligning with Tallman and Pedersen, 2011).

What is really happening is not so much that construction-related businesses are becoming more risky, rather it is that construction markets are becoming more uncertain. The recognition of a difference between risk and uncertainty is critical for success in construction-related businesses. Uncertainty cannot be quantified in the same way that business managers do with risks, i.e., using probabilities. Business managers lack information and knowledge about the future even in the modern world of big data and rapid information dissemination. They may sense deep uncertainty vis-à-vis emerging smart built environments. Thus, both concepts and practices in construction-related BM need to be replaced, renewed, or complemented by insight, knowledge of experts, managers’ judgement, and wisdom from crowds inhabiting built environments across the globe (aligning with Teece and Leih, 2016).

Construction-related business managers themselves play an important part in the co-production of contextual BM knowledge and so they shape how to access BM ideas, translate them into practices as well as develop, share, re-produce, and recycle them. As a common object, construction-related BM knowledge is therefore not only subject to different readings from the eight schools of thought on BM, it is also constituted in truly contextual, complex, and constantly changing ways (aligning with Bresnen, 2017).

5. REFERENCES

- Bresnen, M., 2017, Being careful what we wish for? Challenges and opportunities afforded through engagement with business and management research. *Construction Management and Economics*, 35(1-2), 24-34.
- Cooper, H. M., 1998, *Synthesizing research. A guide for literature reviews*. 3rd edn. SAGE.
- Durand, R., Grant, R. M. and Madsen T. L., 2017, The expanding domain of strategic management research and the quest for integration. *Strategic Management Journal*, 38, 4-16.
- Ghauri, P. and Grønhaug, K., 2002/2005. *Research methods in business studies. A practical guide*. 2nd/3rd edn. Financial Times/Prentice Hall, Harlow, England.
- Hart, C., 1998, *Doing a literature review*. SAGE Publications, London.
- Huovinen, P., 2003, Firm competences in managing a firm's dynamic business in particular in construction markets. Unpublished Licentiate Thesis in Construction Economics and Management. TKK Helsinki University of Technology, Espoo.
- Huovinen, P., 2004, Applied business-management research: How do we incorporate this missing link into our "Revaluing Construction" agenda? In *Proceedings of CIB World Building Congress on Building for the Future*. CIB and NRC. 1-7 May 2004, Toronto, Canada.
- Huovinen, P., 2006a, Contextual platform for advancing the management of construction and engineering businesses: 52 concepts published between the years 1990-2005. In Songer, A., Chinowsky, P. and Carrillo, P. (eds.) *Proceedings of the 2nd Specialty Conference on Leadership and Management in Construction and Engineering – International Perspectives* (pp. 381-388). CIB, ASCE, University of Colorado, Virginia Polytechnic Institute and State University, and Loughborough University. 4-6 May 2006. Grand Bahama Island, Bahamas.
- Huovinen, P., 2006b, Theoretical 52-concept platform for advancing construction-related business management. In Pietroforte, R., De Angelis, E. and Polverino, F. (eds.) *Proceedings of the Joint International Symposium of CIB W55, W65, and W86 on Construction in the XXI Century: Local and Global Challenges*. CIB and La Sapienza, University of Rome, School of Engineering. Edizioni Scientifiche Italiane. 18-20 October 2006, Rome, Italy.
- Huovinen, P., 2008, Platform for advancing research in competence-based business management: A population of 84 concepts published between the years 1990-2002. In Sanchez, R. and Heene, A. (eds.) *A Focused Issue on Fundamental Issues in Competence Theory Development. Research in Competence-Based Management*, 4, 175-218.
- Huovinen, P., 2010, Enhancement of business management for a better construction world: A review of a 62-concept population in 1990-2009. In Barrett, P., Amaratunga, D., Haigh, R., Keraminiyage, K., and Pathirage, C. (eds.) *Proceedings of CIB 2010 World Congress on Building a Better World*. CIB and University of Salford. 10-13 May 2010, Salford, the UK.
- Huovinen P., 2015a, Leveraging concepts for environmentally sustainable business management in construction - a focused review. In Egbu C. (ed.), *Proceedings of CIB 2015 on Going North for Sustainability: Leveraging Knowledge and Innovation for Sustainable Construction and Development* (pp. 286-296). IBEA Publications Ltd. London South Bank University (LSBU) and CIB. 23-25 November 2015, London, the UK.
- Huovinen, P., 2015b, Theoretical 71-concept platform for advancing construction-related business management. In Kähkönen, K., Huovinen, P. and Keinänen, M. (eds.) *Proceedings of the 8th Nordic Conference on Construction Economics and Organization. Procedia Economics and Finance* (pp. 80-87). Vol. 21. Elsevier. RIL, Tampere University of Technology, Department of Civil Engineering, and CREON. 28-29 May 2015, Tampere, Finland.
- Huovinen P., 2016, Relevance of five generic business ideation approaches vis-à-vis contexts embedded within construction markets. In Achour N. (ed.) *Advancing products and services. Proceedings of the CIB World Building Congress 2016*, Vol. V (pp. 1129-1140). CIB, RIL, Aalto University, RYM Oy, Tekes, Tampere University of Technology, and VTT. 30 May – 3 June 2016, Tampere, Finland.
- Koskela, L., 2017, Why is management research irrelevant? *Construction Management and Economics*, 25(1-2), 4-23.

- Leiringer, R. and Dainty, A., 2017, Construction management and economics: New directions. *Construction Management and Economics*, 35(1-2), 1-3.
- Miles, M. B. and Huberman, A. M., 1994, Qualitative data analysis. 2nd edn. SAGE, Thousands Oaks.
- Porter, M. E. and Heppelmann, J. E., 2014, How smart connected products are transforming competition. *Harvard Business Review*, 92(11), 65-88.
- Porter, M. E. and Heppelmann, J. E., 2015, How smart, connected products are transforming companies. *Harvard Business Review*, 93(10), 96-114.
- Tallman, S. and Pedersen, T., 2011, The launch of global strategy journal: Comments from the co-editors. *Global Strategy Journal*, 1, 1-5.
- Teece, D. and Leih, S., 2016, Uncertainty, innovation, and dynamic capabilities: An introduction. *California Management Review*, 58(4), 5-12.

ANNEX. A LIST OF 74 REFERENCES CONTAINING 77 CONSTRUCTION-RELATED BM CONCEPTS PUBLISHED DURING THE YEARS 1990-2016

- Anderson, D. K. and Merna, A., 2005, Project management is a capital investment process. *Journal of Management in Engineering*, 21(4), 173-178.
- Anell, B., 2000, Managing project portfolios. In Lundin, R. A. and Hartman, F. (eds.) *Projects as business constituents and guiding motives* (pp. 77-88). Kluwer, Boston.
- Arto, K. A., 1999, Management across the organisation. Editorial. *Project Management*, 5(1), 4-9.
- Barrett, P., 2000, Achieving strategic facilities management through strong relationships. *Facilities*, 18(10/11/12), 421-426.
- Bashouri, J. and Duncan, G. W., 2014, A model for sharing knowledge in architectural firms. *Construction Innovation*, 14(2), 168-185.
- Bennett, J., 2000, *Construction – the third way*. Butterworth-Heinemann, Oxford.
- Betts, M. and Ofori, G., 1992, Strategic planning for competitive advantage in construction. *Construction Management and Economics*, 10, 511-532.
- Borner, R., 2004, Success factors in construction processes as a key for a benefit oriented knowledge management model. In *Proceedings of CIB World Building Congress on Building for the Future*. CIB and NRC. 1-7 May 2004, Toronto, Canada.
- Bos-de Vos, M., Wamelink, J. W. F. H. and Volker, L., 2016, Trade-offs in the value capture of architectural firms: The significance of professional value. *Construction Management and Economics*, 34(1), 21-34.
- Brege, S., Stehn, L. and Nord, T., 2014, Business models in industrialized building of multi-storey houses. *Construction Management and Economics*, 32(1-2), 208-226.
- Cheng, E. W. L. and Li, H., 2002, Construction partnering process and associated critical success factors. *Journal of Management in Engineering*, 18(4), 194-202.
- Chiang, Y.-H., Tang, B.-S. and Wong, F. K. W., 2008, Volume building as competitive strategy. *Construction Management and Economics*, 26(1), 161-176.
- Chinowsky, P. S. with Meredith, J. E., 2000, *Strategic corporate management for engineering*. Oxford University Press, New York.
- Davies, A. and Brady, T., 2000, Organizational capabilities and learning in complex product systems: Towards repeatable solutions. *Research Policy*, 29, 931-953.
- Davies, A., Brady, T. and Hobday, M., 2007, Organizing for solutions: Systems seller vs. systems integrator. *Industrial Marketing Management*, 36, 183-193.
- Flanagan, R., 1994, The features of successful construction companies in the international construction market. In Warszawski, A. (ed.) *Etkin International Seminar on Strategic Planning in Construction Companies* (pp. 304-318). CIB W65, NBRI, and Tecnion. 8-9 June 2004, Haifa, Israel.
- Girmscheid, G., 2010, Paradigm shift and client focus on industrialization. In Girmscheid, G. and Scheublin, F. (eds.) *New Perspective in Industrialisation in Construction. A State-of-the-Art Report* (pp. 131-137). CIB Task Group 57 Industrialisation in Construction. CIB Publication No. 329. Eigenverlag des IBB an der ETH, Zurich.
- De Haan, J., Voordijk, H. and Joosten, G.-J., 2002, Market strategies and core capabilities in the building industry. *Construction Management and Economics*, 20, 109-118.
- Hawk, D., 1992, *Forming a new industry – International building production*. Document D11. Swedish Council for Building Research, Stockholm.
- Hawk, D., 2006, Conditions of success: A platform for international construction development. *Construction Management and Economics*, 24, 735-742.

- Helander, A. and Möller, K., 2007, System supplier's customer strategy. *Industrial Marketing Management*, 36, 719-730.
- Heywood, C. and Kenley, R., 2008, The sustainable competitive advantage model for corporate real estate. *Journal of Corporate Real Estate*, 10(2), 85-109.
- Hobday, M., 2000, The project-based organization: An ideal form for managing complex products and systems? *Research Policy*, 29, 871-893.
- Huovinen, P., 1999, A recursive competence-based approach for managing a firm in capital investment markets. In Hannus, M., Salonen, M. and Kazi, A. S. (eds.) *Proceedings of 2nd International Conference on Concurrent Engineering in Construction: Challenges for the New Millennium* (pp. 167-176). CIB TG33 and VTT. 25-27 August 1999, Espoo, Finland.
- Huovinen, P., 2001, A framework for designing an international competitive strategy in the case of technology-intensive contractors. In Preece, C. N. (ed.) *Proceedings of 2nd International Construction Marketing Conference* (pp. 68-75). University of Leeds. 19-20 September 2001, Watford, the UK.
- Huovinen, P., 2002, Managing a firm's competitiveness in global capital investment markets. In Uwakweh, B. and Minkarah, I. A. (eds.) *Proceedings of 10th Symposium of CIB W65&W55 on Construction Innovation and Global Competitiveness* (pp. 330-344). University of Cincinnati and CIB. 9-13 September 2002, Cincinnati, the USA. CRC Press, Boca Raton.
- Huovinen, P., 2003, Knowledge-based management of a firm's business in capital investment markets. In Ofori, G. and Ling, F. Y. Y. (eds.) *Proceedings of CIB W55 et al. Symposium on Knowledge Construction* (pp. 367-381). Vol. 1. National University of Singapore and CIB. 22-24 October 2003, Singapore.
- Huovinen, P., 2004, Organization-based management of a project business in capital-investment markets. In *Proceedings of NORDNET 2004 Conference on Successful PM – Art, Science, and Culture*. PM Association in Finland. 29 September – 2 October 2004. Helsinki, Finland.
- Huovinen, P., 2005, Recursive management of a dynamic business in global capital-investment markets. In Kähkönen, K. and Porkka, J. (eds.) *Proceedings of 11th CIB W55, W65 et al. Symposium on Global Perspectives on Management and Economics in the AEC Sector* (pp. 142-153). Vol. 2. VTT, RIL, and CIB. 13-16 June 2005, Helsinki, Finland.
- Huovinen, P., 2011a, Advancement of sustainable development, contracting, design, and supply businesses vis-a-vis construction markets. In Wamelink, H., Geraedts, R., and Volker, L. (eds.) *Proceedings of the MISBE2011 International Conference on Management and Innovation for a Sustainable Built Environment*. CIB, Delft University of Technology, AESOP, and ENHR. 20-23 June 2011. Amsterdam, the Netherlands.
- Huovinen, P., 2011b, Managing of construction-related businesses in environmentally sustainable ways - a focused review of 62 concepts. In Wamelink, H., Geraedts, R., and Volker, L. (eds.) *Proceedings of the MISBE2011 International Conference on Management and Innovation for a Sustainable Built Environment*. CIB, Delft University of Technology, AESOP, and ENHR. 20-23 June 2011. Amsterdam, the Netherlands.
- Huovinen, P. and Hawk, D. L., 2003, Towards collaborative customer-supplier relationships in global building product businesses. In Reponen, T. (ed.) *Information technology-enabled global customer service* (pp. 143-162). Idea Group Publishing, Hershey.
- Jennings, M. J. and Betts, M., 1996, Competitive strategy for quantity surveying practices: The importance of information technology. *Engineering, Construction and Architectural Management*, 3(3), 163-186.
- Johnsson, H., 2011, The building system as a strategic asset in industrialized construction. In Haugbølle, K., Gottlieb, S. C., Kähkönen, K. E., Klakegg, O. J., Lindahl, G. A. and Widén, K. (eds.) *Proceedings of 6th Nordic Conference on Construction Economics and Organisation – Shaping the Construction/Society Nexus, Construction in Society* (pp. 541-552). Vol. 3. Danish Building Research Institute and Aalborg University. 13-15 April 2011, Copenhagen, Denmark.
- Kale, S. and Arditi, D., 2002, Competitive positioning in US construction industry. *Journal of Construction Engineering and Management*, 128(3), 238-247.
- Kaya, S., Heywood, C. A., Arge, K., Brawn, G. and Alexander, K., 2004, Raising facilities management's profile in organizations: Developing a world-class framework. *Journal of Facilities Management*, 3(1), 65-82.
- Keenan, J. M., 2016, From sustainability to adaptation: Goldman Sachs' corporate real estate strategy. *Building Research & Information*, 44(4), 407-422.
- Kendall, G. J., 2003, Profit-driven portfolios. *PM Network*, 17(5), 48-53.
- Kiiras, J. and Huovinen, P., 2004, The virtual project management (PM) services company – in the case of construction markets in Finland. In *Proceedings of CIB World Building Congress 2004*. CIB and NRC. 1-7 May 2004, Toronto, Canada.
- Kujala, S., Artto, K., Aaltonen, P. and Turkulainen, V., 2010, Business models in project-based firms - Towards a typology of solution-specific business models. *International Journal of Project Management*, 28, 96-106.
- Lampel, J., 2001, The core competencies of effective project execution: The challenge of diversity. *International Journal of Project Management*, 19, 471-483.
- Langford, D. and Male, S., 2001, *Strategic management in construction*. 2nd ed. Blackwell, Oxford.

- Leinberger, C. B., 1993, *Strategy for real estate companies*. The Urban Land Institute and The Association for Commercial Real Estate, Washington.
- Lindholm, A.-L., Gibler, K. M. and Leväinen, K. I., 2006, Modeling the value-adding attributes of real estate to the wealth maximization of the firm. *Journal of Real Estate Research*, 28(4), 445-475.
- Love, P. E. D., Li, H., Irani, Z. and Faniran, O., 2000, Total quality management and the learning organization: A dialogue for change in construction. *Construction Management and Economics*, 18, 321-331.
- Love, P. E. D., Irani, Z., Cheng, E. and Li, H., 2002, A model for supporting inter-organizational relations in the supply chain. *Engineering, Construction and Architectural Management*, 9(1), 2-15.
- Løwendahl, B., 1997/2001, *Strategic management of professional service firms*. 1st ed./2nd ed. Copenhagen Business School (Handelshøjskolens Forlag), Copenhagen.
- Macmillan, I. C. and Selden, L., 2008, The incumbent's advantage. *Harvard Business Review*, 86(10), 111-121.
- Meklin, J., Lahti, M., Kovanen, V., Arenius, M. and Artto, K. A., 1999, *FITPRO- A product-oriented approach to industrial project management*. PM Association in Finland, Helsinki.
- Metais, E. and Meschi, P.-X., 2005, Competence-based management and strategic flexibility: The case of Air Liquide. *Advances in Applied Business Strategy. Competence Perspectives on Managing Internal Processes*, 7, 91-107.
- Milosevic, D. Z. and Srivannaboon, S., 2006, A theoretical framework for aligning project management with business strategy. *Project Management Journal*, 37(3), 98-110.
- Mitchell-Ketzes, S., 2003, Optimising business performance through innovative workplace strategies. *Journal of Facilities Management*, 2(3), 258-275.
- Morris, P. W. G. and Jamieson, A., 2005, Moving from corporate strategy to project strategy. *Project Management Journal*, 36(4), 5-18.
- Mutka, S. and Aaltonen, P., 2013, The impact of a delivery project's business model in a project-based firm. *International Journal of Project Management*, 31, 166-176.
- Osgood Jr., R. T., 2004, Translating organizational strategy into real estate action: The strategy alignment model. *Journal of Corporate Real Estate*, 6(2), 106-117.
- Pinto, J. K., Rouhiainen, P. and Trailer, J. W., 2000, Project success and customer satisfaction: Toward a formalized linkage mechanism. In Lundin, R. A. and Hartman, F. (eds.) *Projects as business constituents and guiding motives* (pp. 103-115). Kluwer, Boston.
- Rapp, R. R., 2001, Business strategy: Ideas for construction Master's degrees. *Leadership and Management in Engineering*, 1(April), 37-42.
- Robinson, H. S., Carillo, P., Anumba, C. J. and Al-Ghassan, A. M., 2002, Knowledge management for continuous improvement in project organizations. In Uwakweh, B. and Minkarah, I. A. (eds.) *Proceedings of 10th Symposium of CIB W65&W55 on Construction Innovation and Global Competitiveness* (pp. 680-697). University of Cincinnati and CIB. 9-13 September 2002, Cincinnati, the USA. CRC Press, Boca Raton.
- Rogers, P. A., 2004, Performance matters: How the high performance business unit leverages facilities management effectiveness. *Journal of Facilities Management*, 3, 371-381.
- Roulac, S. E., 1999, Real estate value chain connections: Tangible and transparent. *Journal of Real Estate Research*, 17(3), 387-404.
- Roulac, S. E., 2001, Corporate property strategy is integral to corporate business strategy. *Journal of Real Estate Research*, 22(1-2), 129-152.
- Salonen, A., Gabrielsson, M. and Al-Obaidi, Z., 2006, Systems sales as a competitive response to the Asian challenge: Case of a global ship power supplier. *Industrial Marketing Management*, 35, 740-750.
- Sauer, C., Liu, L. and Johnston, K., 2001, Where project managers are kings. *Project Management Journal*, 32(4), 39-49.
- Singer, B. P., Bossink, B. A. G. and Vande Putte, H. J. M., 2007, Corporate real estate and competitive strategy. *Journal of Corporate Real Estate*, 9(1), 25-38.
- Tansey, P., Spillane, J. P. and Meng, X., 2014, Linking response strategies adopted by construction firms during the 2007 economic recession to Porter's generic strategies. *Construction Management and Economics*, 32(7-8), 705-724.
- Then, D. S. S., Tan, T. H., Santovito, R. and Jensen, P. A., 2014, Attributes of alignment of real estate and facilities management to business needs. *Journal of Corporate Real Estate*, 16(2), 80-96.
- Thiry, M. and Deguire, M., 2007, Recent developments in project-based organizations. *International Journal of Project Management*, 25, 649-658.
- Trejo, D., Shekhar, P., Anderson, S. and Cervantes, E., 2002, Framework for competency and capability assessment for resource allocation. *Journal of Management in Engineering*, 18(1), 44-49.
- Turner, R. and Keegan, A., 2000, The management of operations in the project-based organization. *Journal of Change Management*, 1(2), 131-148.
- Veshosky, D., 1994, Portfolio approach to strategic management of A/E firms. *Journal of Management in Engineering*, 10(5), 41-47.

- Walker, D. H. T., 2005, Having a knowledge competitive advantage (K-Adv): A social capital perspective. In Ribeiro, F. L., Love, P. D. E., Davidson, C. H., Egbu, C. O. and Dimitrijevic, B. (eds.) *Proceedings of Conference on Information and KM in A Global Economy* (pp. 13-31). CIB and IST. 19-20 May, Lisbon, Portugal.
- Whitla, P., Walters, P. and Davies, H., 2006, The use of global strategies by British construction firms. *Construction Management and Economics*, 24, 945-954.
- Wikström, K., Artto, K., Kujala, J. and Söderlund, J., 2010, Business models in project business. *International Journal of Project Management*, 28, 832-841.
- Winch, G. and Schneider, E., 1993, The strategic management of architectural practice. *Construction Management and Economics*, 11, 467-473.

SHAPING CLIENT-DRIVEN BUSINESS MANAGEMENT CONCEPTS FOR MODERN CONSTRUCTION MARKETS

P. Huovinen¹, K. Haugbølle² and M. Oostra³

¹ *Business Management in Construction, Civil Engineering, Tampere University of Technology, P.O. Box 600, FI-3310 Tampere, Finland*

² *Research Group on Construction Management and Innovation, Danish Building Research Institute (and Aalborg University), A.C. Meyers Vaenge 15, DK-2450 Copenhagen SV, Denmark*

³ *Research Centre for Built Environment NoorderRuimte, Hanze University of Applied Sciences, P.O. Box 3037, 9701 DA Groningen, The Netherlands*

Email: pekka.huovinen@tut.fi

Abstract: The pioneering review has revealed that various authors have designed and published 77 construction-related business management (BM) concepts during the years 1990-2016 (Huovinen, 2017). In turn, the two-fold aim of our paper is to explore the degrees to which these BM concepts have been designed along the client-driven dimension and to suggest the ways to shape future BM concepts to better accommodate client views in modern construction markets. Our focused review found that 49 (57%) authors have designed their BM concepts along the client-driven sub-dimensions, i.e., 7 to high degrees, 14 to medium degrees, and 28 to low degrees. A further scrutiny of the seven highly client-driven BM concepts revealed that the six sub-dimensions may be of particular importance to take into account when shaping future BM concepts to accommodate client perspectives. These sub-dimensions include (i) client needs, (ii) client base, (iii) buyer-seller collaboration, (iv) sellers' strategies, (v) buyers' strategies, and (vi) services' use, professional, and exchange values. It is envisioned that this focus on client-driven BM will trigger a flow of collaborative R&D&I programs.

Keywords: Business Management, Clients, Construction Markets, Literature Review, Marketing

1. INTRODUCTION

Research into clients and users in construction provides economic, social, and environmental benefits to society, business, government, and academia. The goal of client-focused research is to advance professional behavior among all kinds of clients on the construction demand side. Root clients like investors and owners are playing key roles under complex contractual settings (aligning with Haugbølle and Boyd, 2016). Herein, we are approaching clients traditionally via the supply side, i.e., sellers managing businesses and nurturing buyer relationships. In contractual chains, many parties assume dual roles of sellers and buyers.

The *nature* of our paper is that of reporting on the conduct and findings of a *focused review* of construction-related business management (BM) concepts designed along the client-driven dimension. The *main aim* is to shape the design and content of future BM concepts along the client-driven dimension vis-à-vis firms competing in modern construction markets. We have approached this aim via the answering to the *three research questions* as follows:

- What are the schools of thought on generic BM that guide the design of generic and applied BM concepts, including those with contexts in modern construction markets?
- What are the degrees up to which the authors have designed 77 construction-related BM concepts (published during the years 1990-2016) along the client-driven dimension?
- How to shape the design and content of client-driven, construction-related BM concepts?

The eight schools of thought on generic BM are introduced in Section 2. The review method is reported upon in Section 3. The findings are overviewed in Section 4. The seven highly client-driven BM concepts are briefed and the shaping of BM concepts along the six client-driven sub-dimensions is discussed in Section 5. The conclusions are put forth in Section 6.

2. EIGHT SCHOOLS OF THOUGHT ON GENERIC BUSINESS MANAGEMENT

Since the early 1980s, many distinguished authors have replied to the fundamental question “What is a principal way of managing a business that will enable managers to set challenging business goals and attain them?” One of the co-authors of this paper has been identifying an abundance of replies as assumptions, arguments, definitions, concepts, frameworks, models, explanations, predictions, prescriptions, and even some claimed theories. Consequently, he has arranged the converging and diverging replies into a typology of the *eight schools of thought on generic BM* as follows (Huovinen, 2003a and 2008):

1. Focused, (from markets) outside-in (firms) school of Porterian BM proposes that managers can achieve superior business performance by integrating a chain of causalities, including differentiation and cost leadership strategies (e.g., Porter, 1994).
2. Focused, (from a firm’s) inside-out (to markets) school of resource-based BM proposes that managers can sustain high performance in businesses by developing and exploiting valuable, rare, and inimitable resources (e.g., Barney, 2002).
3. Focused, inside-out school of competence-based BM proposes that managers can attain their business goals and sustain above normal rents by building and leveraging organizational competences (e.g., Sanchez and Heene, 2004).
4. Broad, inside-out school of knowledge-based BM proposes that managers can develop competitive advantages by creating and managing knowledge, nurturing intellectual capital, and enhancing learning (e.g., Nonaka and Takeuchi, 1995).
5. Broad, inside-out school of organization-based BM proposes that managers can achieve high performance by relying on organizational solutions in focal spheres of make/buy decisions, inter-/externalization, globalization, multiple markets, and multiple, networked stakeholders (e.g., Bartlett and Ghoshal, 1989/1998).
6. Broad, inside-out school of process-based BM proposes that managers can achieve high performance by running businesses as sequenced, deliberate, and/or emergent processes, such as incremental building, growth, change, and internationalization (e.g., Johansson and Vahlne, 2009).
7. Broad, inside-out and outside-in school of dynamism-based BM proposes that managers can achieve high performance by perceiving businesses as fast strategy games in unstable markets, nurturing core competences, innovating business models and disruptive technologies, and renewing edges (e.g., Hamel and Prahalad, 1994).
8. Focused, outside-in school of evolutionary BM proposes that managers can achieve high performance even in chaotic external environments by enacting internal and external forces that affect destinies of firms and businesses (e.g., Burgelman, 2002).

3. METHOD OF THIS FOCUSED, CLIENT-DRIVEN REVIEW

The conduct of the *17-year, total reviewing process* has been reported in Huovinen (2003a, 2008, and 2017). So far, the pioneering reviewing has resulted in the identification of 74 references that contain 77 construction-related BM concepts, published during the years 1990-

2016. In this paper, *client-driven BM* involves firms that are preferring clients as a dimension, outside-in founding blocks, or simply elements in managing of their construction-related businesses, respectively. This client-driven review was conducted as 77 concept-specific assessments. The *four degrees* of the design of client-driven BM concepts were pre-defined as follows:

- *High degree*: an author has designed a BM concept by choosing a client-driven dimension as one of the primary dimensions and by defining many key elements, such as client-driven goals, business ideas, offerings, strategies, processes, or contracting.
- *Medium degree*: an author has designed one or more client-driven key elements as part of a BM concept.
- *Low degree*: an author has only named client-driven issues in a reference, such as client orientation, client needs, or client requirements. No client-driven elements are included.
- *No degree*: an author is silent vis-à-vis clients as part of construction-related BM. Not even one explicit client-driven ‘phrase’ is included into a reference.

Overall, the assessment revealed that 49 (64%) *construction-related BM concepts include the client-driven dimensions, elements, or issues*. The *assessment validity* was protected against the three biases as follows. (B1) A *concept inclusion bias* is related to a fact that one of the three reviewers has (co-)designed 9 (12%) BM concepts along the client-driven dimension. This bias was minimized by assessing each reference in the same way and quoting exactly the minimum relevant parts. Future reviewers can test the inter-concept consistency, repeat the assessments, compare the degrees as well as possibly detect differences and therein reveal reasons for them. (B2) A *concept exclusion bias* is related to 28 no-degree assessments. Again, future reviewers may test these exclusions through the analytical reading of the same 74 references (see a list) containing 77 BM concepts. (B3) A *degree assessment bias* is related to the reliance on the four degrees (high, medium, low, and no) instead of one of more rigorous, quantitative scales. This 4-degree lens was selected to correspond to the explorative nature of this client-driven review. We could assign each BM concept to one degree, by using the pre-definitions. Future reviewers may specify degrees differently, like by dividing each degree into sub-degrees and differentiating among the current same-degree BM concepts.

4. SEVEN HIGHLY CLIENT-DRIVEN BUSINESS MANAGEMENT CONCEPTS

Ex ante, it was hypothesized that only some authors have incorporated client-driven elements to high degrees into their BM concepts. Indeed, *there are only 7 (14%) high-degree concepts, 14 (29%) medium-degree concepts, and 28 (57%) low-degree concepts* (Table 1). The 77 *concept-specific assessments* and quoted terms are compiled in Tables 2-8, school by school, except that no evolutionary BM concepts related to construction have been identified.

Table 1: Three-degree assessment of the design of 49 construction-related BM concepts (published during the years 1990-2016) along the client-driven dimension, by school of thought on BM.

School of thought on BM	High-degree BM concepts		Medium-degree BM concepts		Low-degree BM concepts		BM concepts with client-driven elements	
	No.	(%)	No.	(%)	No.	(%)	No.	(%)
1 Porterian school	3	(6%)	5	(10%)	5	(10%)	13	(27%)
2 Resource-based school	1	(2%)	0	(0%)	0	(0%)	1	(2%)

3 Competence-based school	1 (2%)	1 (2%)	1 (2%)	3 (6%)
4 Knowledge-based school	0 (0%)	2 (4%)	3 (6%)	5 (10%)
5 Organization-based school	1 (2%)	0 (0%)	8 (16%)	9 (18%)
6 Process-based school	0 (0%)	1 (2%)	3 (6%)	4 (8%)
7 Dynamism-based school	1 (2%)	5 (10%)	8 (16%)	14 (29%)
8 Evolutionary school	0 (0%)	0 (0%)	0 (0%)	0 (0%)
Sum	7 (14%)	14 (29%)	28 (57%)	49 (100%)

Table 2: Client-driven degrees of 17 construction-related Porterian BM concepts, published during the years 1990-2016 (1st school).

Author (Year)	BM concept and focal context	Assessed client-driven degree based on key quotations (page no.)
Winch, Schneider (1993)	2x2 matrix: Four strategies: strong delivery, experience, ideas, and ambition for UK architectural practices	<u>HIGH</u> : The primary dimensions are (i) clients' preference for quality (client review or peer review) and (ii) project type (complex or simple) (471)
Jennings, Betts (1996)	Model and 4 strategies: execution, expertise, efficiency, and experience for UK quantity surveying practices	<u>HIGH</u> : Primary dimensions: (i) regular, faithful client base (specific, varied) and (ii) level of service to meet clients' requests (simple, complex) (178-9)
Pinto et al. (2000)	Subcontractor's and clients' value chains, customer-based project success	<u>HIGH</u> : Subcontractor as a partner enhances clients' competitive advantages and operations (108)
Roulac (2001)	8 strategies and 7 contributions of superior corporate strategy to competitive advantages in US real estate	<u>Medium</u> : Places and spaces can enhance or frustrate access by customers (143). Creating and retaining customers as 1 (out of 7) contributions (145).
Huovinen (2001)	4-area framework for technology-intensive contractors to design strategies, to offer/tailor solutions	<u>Medium</u> : 3 dimensions include (i) foreign investors with business scope, procurement, need, contract, (ii) focal contractor, and (iii) competitors (69, 73)
Langford, Male (2001)	Adapted 5 forces shape the UK industry structure	<u>Medium</u> : Bargaining power of owners (clients) as 1 (out of) 5 competitive forces
Rapp (2001)	Adapted 5 forces (incl. speedy response) and a client value chain in the US construction	<u>Medium</u> : Bargaining power of clients as 1 (out of) 5 competitive forces (39). Client service follow-up as 1 (out of) 5 elements in value chains (40).
Singer et al. (2007)	Real estate and competitive strategies model in Dutch companies	<u>Medium</u> : Creating customer loyalty by selling unique product/service with a differentiation strategy. Serving customers with a focus strategy (29).
Veshosky (1994)	Analytical, applied framework for the design segment of the A/E/C industry in the USA	<u>Low</u> : Focus/niche strategies with differentiation involve responsiveness to clients' needs as 1 (out of 5) opportunity areas (43)
Roulac (1999)	Real estate (RE) value chains for supporting US firms' businesses	<u>Low</u> : RE supports a firm to deliver goods, services to customers and their customers (389). Buyers are attracted to a retail distribution system (398-389).
Kale, Arditi (2002)	Mode (cost, quality, time, innovation), scope (geography, delivery, clients)	<u>Low</u> : Improving communications with US clients and consultants, meeting needs effectively (240)
Huovinen (2011a)	4 sustainable businesses in 8 arenas in construction markets	<u>Low</u> : Each incumbent occupies 2 roles of a procurer and a seller (3)
Tansey et al. (2014)	Taxonomy of 60 response strategies of Irish and UK construction firms to recession	<u>Low</u> : 2 client-driven strategies: (i) service a specific client group to enhance reputation and relations (712); (ii) target less vulnerable clients (715)
Betts, Ofori (1992)	Use of Porterian concepts in construction firms in the UK	No degree
Milosevic, Srivannaboon (2006)	Framework for aligning PM and a firm's business strategy in US engineering, industrial firms	No degree
Chiang et al. (2008)	Volume building strategy of contractors in Hong Kong	No degree
Heywood, Kenley (2008)	Competitive advantage model for corporate RE in Australia	No degree

Table 3: Client-driven degrees of 2 construction-related resource-based BM concepts, published during the years 1990-2016 (2nd school).

Author (Year)	BM concept and focal context	Assessed client-driven degree based on key quotations (page no.)
Lowendahl (1997)	3 strategies, 4 resources, 4 dimensions for differentiation, and 3 phases for US professional service firms	<u>HIGH</u> : The three strategies based on (a) client relation, (b) solution or output, and (c) problem solving or creativity (120-130)
Johnsson (2011)	Building system as a strategic asset for industrialized companies in Sweden	No degree [Only the key client types and relations of the case company are reported upon.]

Table 4: Client-driven degrees of 5 construction-related competence-based BM concepts, published during the years 1990-2016 (3rd school).

Author (Year)	BM concept and focal context	Assessed client-driven degree based on key quotations (page no.)
Helander, Möller (2007)	Dynamic model for a complex system supplier's customer strategy and managing supplier-client relations	<u>HIGH</u> : A customer's 3 strategies are a basis for the design and coupling of a supplier's 3 roles, respectively (722-725)
Langford, Male (2001)	Strategies for international construction and the internationalization of UK firms	<u>Medium</u> : 1 (out of 9) sources of competitive advantage includes the identification of user/client needs via market research and partnerships with clients (137)
Davies et al. (2007)	Model of a pure systems seller vs. a pure systems integrator for organizing capital goods into systems, globally	<u>Low</u> : Customer demand for more complex solutions is an important driver behind the emergence of systems integrators offering multi-vendor solutions (188)
Huovinen (1999)	Recursive, competence-based framework for managing a firm in capital investment markets	No degree
Trejo et al. (2002)	Capability assessment for core competency development in US construction & engineering	No degree

Table 5: Client-driven degrees of 11 construction-related knowledge-based BM concepts, published during the years 1990-2016 (4th school).

Author (Year)	BM concept and focal context	Assessed client-driven degree based on key quotations (page no.)
Hawk (2006; 1992)	Continual learning system based on a learning capability in international building	<u>Medium</u> : 2 (out of 10) recommendations are (i) embracing changing consumer ideals and (ii) seeking new business ideas in customer relationships (737-8)
Borner (2004)	Project and success-oriented KM model for design-build contractors in Swiss markets based on the creation and re-activation of knowledge clusters for new projects	<u>Medium</u> : Incorporation of changing needs of the customer/flexibility as 1 (out of 7) cross-section knowledge clusters, coupled with the transparency of a design-build contractor (6). Customer satisfaction and loyalty as part of a strategic target level (8).
Love et al. (2000)	Conceptual model for a learning organization (LO) in construction	<u>Low</u> : Improved customer-supplier relations as 1 (out of 4) reasons for a LO
Love et al. (2002)	Model for a construction alliance founded on TQM and an integrated supply chain, contexts of Hong Kong	<u>Low</u> : Customer is 1 (out of 3) elements in a learning culture (7), satisfying requirements with quality products as 1 (out of 10) rules of an alliance charter (12)
Huovinen (2003b)	System for managing a 5-element, capital investments-based business in KM ways	<u>Low</u> : Value-adding knowledge enables to pre-empt or over-satisfy client needs. A front-line offers best solutions and manages contracts for high satisfaction (377)
Anell (2000)	Matrix for a Nordic firm's project portfolio management	No degree
Davies, Brady (2000)	Organizational learning-cycle model for UK firms offering complex product systems	No degree
Langford, Male (2001)	4 ways of knowledge-based management (use knowledge, learn from the	No degree

	past, develop management, anticipate staff turnover) in the UK construction	
Robinson et al. (2002)	KM framework including knowledge maps for continuous improvement in UK project organizations	No degree
Walker (2005)	Knowledge competitive advantage (K-Adv) concept for Australian construction firms	No degree
Bashouri, Duncan (2014)	Framework or model for knowledge sharing within architectural firms with communities of practice (CoPs)	No degree [The KM sharing model is only linked to a firm's overall business strategy, such as Winch and Schneider's (1993) four generic, Porterian strategies.]

Table 6: Client-driven degrees of 15 construction-related organization-based BM concepts, published during the years 1990-2016 (5th school).

Author (Year)	BM concept and focal context	Assessed client-driven degree based on key quotations (page no.)
Huovinen, Hawk (2003)	Model for global building product suppliers to manage collaborative customer-supplier relationships	<u>HIGH</u> : 4 (out of 5) elements: (i) select customers, (ii) master customers' procurement methods, (iii) meet preferences, and (iv) learn, master relationships (147).
Leinberger (1993)	Managerial systems change strategy in US process-oriented real estate	<u>Low</u> : 2 (out of 5) marketing characteristics; repeat business, satisfying similar customers (21-27, 63-75)
Flanagan (1994)	Successful UK construction company in the year 2000	<u>Low</u> : Closeness to customers, user markets (312). Customer care programs (318).
Artto (1999)	Organizational model for PM in a project-oriented company	No degree
Bennett (2000)	7 partnering pillars balance competition & cooperation in UK construction	<u>Low</u> : Organizations involve customers in their decisions (83), benchmarked value for customers (92)
Hobday (2000)	Project-based organization (PBO), a single project firm with complex product systems	<u>Low</u> : PBO responds flexibly to changing client needs (871). A customer is directly engaged in innovation and production (875).
Turner, Keegan (2000)	Four operations management models (i-iv) in a project-based organization (PBO), offerings vs. bespoke designs	<u>Low</u> : (i) Large projects for few clients (ii) large projects for many clients, (iii) small projects for few clients, (iv) small projects for many clients (139-144)
Huovinen (2004)	Managing 5-element, capital investments-based business in organization-based ways	<u>Low</u> : Value-adding front-line enables to preempt/over-satisfy needs, offer best solutions, manage contracts for high satisfaction (3-4)
Kiiras, Huovinen (2004)	From building contractors to a virtual CM company model	<u>Low</u> : Company and projects managers are responsible for client relationships (6).
Wikström et al. (2010)	3 models in project business: (i) projects, (ii) project networks, (iii) business networks	<u>Low</u> : Customer involvement is 1 (out of 14) elements. Core competences include customer knowledge and flexibility involves customer-oriented solutions (838).
Davies, Brady (2000)	Capability building and internal interactions, for complex product systems	No degree
Sauer et al. (2001)	PM-centered organization in the Australian construction	No degree
Cheng, Li (2002)	Customized process model of partnering in the construction in Hong Kong	No degree
Kendall (2003)	Support to PMO, project-driven firms	No degree
Thiry, De-guire (2007)	Integration in project-based organizations (PBOs)	No degree

Table 7: Client-driven degrees of 8 construction-related process-based BM concepts, published during the years 1990-2016 (6th school).

Author (Year)	BM concept and focal context	Assessed client-driven degree based on key quotations (page no.)
Salonen et al. (2006)	8-element process model of a global ship power systems integrator	<u>Medium</u> : Fulfilling needs with maximum value and communicating this value to buying centres (742-5)

Kaya et al. (2004)	World-class FM framework for UK-based firms	<u>Low</u> : Customer satisfaction as 1 (out of 3) factors influencing results (74).
Lindholm et al. (2006)	Model for value adding real estate in firms	<u>Low</u> : Model is linked to the customer perspective of balanced scorecards (469).
Then et al. (2014)	Firm's business-real estate/facility management alignment model	<u>Low</u> : To enable customers' success as 1 (out of 7) propositions; services as 1 (out of 4) parameters
Rogers (2004)	High performance FM services in NZ	No degree
Anderson, Merna (2005)	Business development process in PM services in the UK	No degree
Morris, Jami-esson (2005)	Linking corporate strategies and project strategies in firms	No degree
Whitla et al. (2006)	Global strategies for contractors based in Hong Kong	No degree

Table 8: Client-driven degrees of 19 construction-related dynamism-based BM concepts, published during the years 1990-2016 (7th school).

Author (Year)	BM concept and focal context	Assessed client-driven degree based on key quotations (page no.)
Bos-de Vos et al. (2016)	Applied framework for value capture and delivery by professional service firms (PSFs) and tradeoffs, in the contexts of Dutch architectural firms	<u>HIGH</u> : 3 value dimensions: (i) creating use value as quality or utility for customers, (ii) creating professional value for PSFs, (iii) capturing exchange value as paid prices (24, 32). Trade-offs via PSF-client interactions.
Mitchell-Ketzes (2003)	Workplaces linked to US businesses through innovative workplace strategies and balanced scorecard	<u>Medium</u> : In customer domain, (a) demonstrate new offerings, (b) shift to a partner, (c) design workplace as a showcase, (d) walk the talk, (e) change mindset (270)
Metais, Meschi (2005)	Core competence-based strategy for flexibility of a French (oil & gas) plant contractor via its value chain, architecture	<u>Medium</u> : Client-driven elements: Approaching customers, customers accept proposals (98), customer relationships and customer-specific solutions (99)
Macmillan, Selden (2008)	Incumbent's advantage in order to serve profitable customers' unmet needs with a customer-centric information base	<u>Medium</u> : Client-driven elements: A global building products supplier of Mexico understands and segments customers' needs, analyzes customers' profitability, organizes business units by these segments (111-112)
Girmscheid (2010)	Industrialization in construction based on 3 business models and an ability to adapt products to client requests	<u>Medium</u> : Client-driven elements: Innovations initiated by clients, individualized design, clients' requirements, loyalty, interfaces, clients' influence on design (133-6)
Kujala et al. (2010)	Typology of 5 solution-specific business models with 6 elements for power plant suppliers	<u>Medium</u> : Suppliers' increasing responsibility for customers' businesses (96). Customers and value propositions as 2 elements (100)
Lampel (2001)	EPC contractor's core project processes (modified core competencies) and 3 strategies	<u>Low</u> : Relational competencies for managing client relationships. Relational competencies are 1 of 4 EPC core competencies. (475)
de Haan et al. (2002)	5-element strategies (a fit btw. market, strategy, capabilities, ex-/ internal conditions in the Dutch building industry)	<u>Low</u> : Client-driven values: Customers are characterized. Contractor translates customer needs into standard products. Manufacturer approaches directly consumers. (117)
Huovinen (2002)	5-element competitiveness framework for firms in global capital investment markets	<u>Low</u> : Mastering clients' procurement strategies. Frontline offers best solutions to clients and manages contracts for high satisfaction
Osgood Jr. (2004)	5-area strategy alignment map and model for US real estate and businesses	<u>Low</u> : A business organization and corporate real estate are aligned via customers and markets as 1 (out of 5) areas (108)
Huovinen (2005)	Recursive, global, capital investments-based BM as 3 systems	<u>Low</u> : Client-driven values: Targeting, knowing attractive clients (149), caring global and local clients (151)
Huovinen (2011b)	High-sustainability BM concept for construction contexts	<u>Low</u> : Frontline as 1 (out of 5) elements offers best solutions, manages contracts for high satisfaction (11)
Mutka, Aaltonen (2013)	8-element business model framework for a (metallurgical) processing technology supplier	<u>Low</u> : Customers is 1 (out of 8) internal elements.

Brege et al. (2014)	3-part business model construct adapted for industrialized building of multi-storey dwellings	<u>Low</u> : End-user segments is (1 out of 5) business model elements, with a variance in standards and degrees of customer adaptation to fit types of living (214, 216)
Meklin et al. (1999)	Framework of a Finnish firm's project business management	No degree
Barrett (2000)	FM model with linking FM and core businesses in the UK	No degree
Chinowsky with Meredith (2000)	7 areas of strategic management, competency maps in US civil engineering organizations	No degree
Langford, Male (2001)	Contingency model for managing a UK construction company	No degree
Keenan (2016)	Integration of real estate, business continuum, adaptive capacity	No degree [The focus of the framework is on internal relations, aiming at sustainability.]

5. SHAPING OF FUTURE BUSINESS MANAGEMENT CONCEPTS ALONG THE SIX CLIENT-DRIVEN SUB-DIMENSIONS

The seven authors have designed their respective high-degree BM concepts along the *six client-driven sub-dimensions*, i.e., client needs, client base, buyer-seller collaboration, sellers' strategies, buyers' strategies, and services' use, professional, and exchange values. By sub-dimension, we are briefing the high-degree BM concepts as well as suggesting and discussing the shaping of the design and content of future construction-related BM concepts as follows.

(i) The *client needs sub-dimension* is drawn from Winch and Schneider's (1993, pp. 471-472) *four high-degree, Porterian strategies* for architectural practices in the UK that are based on project complexity and client quality preference. Strategy 1 is strong delivery of simple buildings. Strategy 2 is strong experience and value engineering related to complex or unusual buildings. Strategy 3 are strong ideas related to a limited market of prestige buildings. Strategy 4 is strong ambition used by new practices. In turn, we suggest that future BM concepts be shaped to accommodate various investment needs within a spectrum between complex and simple construction objects. Need-driven BM concepts enable firms to productize, servitize, customize, and digitalize their offerings based on both the foreseeing of evolving complex client needs and the recognition of affordable simple client needs in private, public, and third sectors across multiple regions and countries.

(ii) The *client base sub-dimension* is drawn from Jennings and Betts' (1996, pp. 178-179) *four high-degree, Porterian strategies* for quantity surveying practices in the UK that are based on (i) a regular, faithful client base (varied and specific) and (ii) service levels for meeting clients' requests (simple and complex). Strategy A is differentiation-based execution, suited to smaller practices with a varied, repeat client base and simple, tailored services. Strategy B is differentiation-based expertise, suited to larger practices with niche clients, new areas, and complex services. Strategy C is cost focus-based efficiency, suited to fairly new practices with simple, fixed projects. Strategy D is differentiation focus-based experience, suited to larger practices with bonded clients and complex projects. In turn, we suggest that future BM concepts be shaped by client groups, segments, types, investment behavior, or their procurement strategies. Client base-driven BM concepts enable firms to differentiate offerings and strategies to meet complex and simple situations among new and repeat clients.

(iii) The *collaborative buyer-seller sub-dimension* is drawn from the two concepts. Pinto, Rouhiainen, and Trailer's (2000, pp. 107-109) *high-degree, Porterian value chain analysis*, for

client-based project success, is based on project supplier-client partnering. A supplier redefines itself as a long-term partner for enhancing each client's operational advantages and eliminating disadvantages. A supplier tailors project bidding, engineering, design, fabrication, and delivery processes for prices that give clients advantages over using competing methods or contractors. Satisfaction is ensured via contract development. A supplier also enters cooperation with other subcontractors in order to offer superior services to clients. Huovinen and Hawk (2003 p. 147, 161) have designed their *high-degree, organization-based model* for the management of collaborative client-supplier relationships in the case of global building products suppliers. Suppliers can deepen collaboration by (a) selecting primary client groups, (b) learning clients' procurement methods and role requirements, (c) meeting clients' preferences, and (d) gradually mastering key states in relationships. In turn, we suggest that future BM concepts be shaped to accommodate the integration of joint value delivery systems or networks that serve also sellers' buyers' buyers and direct collaboration as part of buyer-seller contractual settings.

(iv) The *sellers' strategies sub-dimension* is drawn from Løwendahl's (2000, pp. 120-130) *three high-degree, resource-based strategies* that she has designed for US professional services firms. (a) Client relation based strategies are enabled by unique abilities to understand and help particular clients. (b) Solution or output based strategies are enabled by superior collective capabilities or organizational competences. (c) Problem solving or creativity based strategies are enabled by innovations in most complex firms. In turn, we suggest that future BM concepts be shaped to enable the concurrent exploitation of buyer relation based strategies by the servicing of buying centers, solution based strategies by integration and co-production, and problem solving based strategies by the joint commercialization of focal innovations.

(v) The *buyers' strategies sub-dimension* is drawn from Helander and Möller's (2007, pp. 722-725) *high-degree, competence-based model for a system supplier's client strategy* that is based on the three strategies of clients: A independence of suppliers, B shared expertise with suppliers, and C reliance on suppliers' expertise. A supplier assumes (a) an equipment/material supplier role with independent clients, (b) a solution provider role with sharing clients, and (c) a performance provider role with dependent clients. In turn, we suggest that future BM concepts be shaped based on the categorization of attractive, potential buyers in terms of each buyer's investment need and strategy, buying strategy, and contract form as well as the coupling and tailoring of a focal system seller's strategies to accommodate each of such buyer categories.

(vi) The *services' value sub-dimension* is drawn from Bos-de Vos, Wamelink, and Volker's (2016, p. 24, 27, 29, 32) *dynamism-based framework that they have designed for value creation and capture as well as handling tradeoffs in the case of Dutch architectural firms*. Value creation includes (a) use value as quality or utility for clients and (b) professional value for firms. Value capture involves (1) use value captured by clients, (2) professional value appropriated by firms, and (3) exchange value as prices paid by clients to firms. Firms use service offer strategies for creating potential use and professional values and for maximizing exchange value. Firms use service delivery strategies for safeguarding or maximizing the capture of professional value. In turn, we suggest that future BM concepts be shaped to enable professional service sellers to balance their value-driven strategies in terms of value types, contract parties, value creation processes, and value capture processes.

6. CONCLUSIONS

We are herein concluding that the theoretical advancement of each of these seven highly client-driven BM concepts is only moderate. The authors have adopted the school-specific generic bases (e.g., Porter's competitive strategies) and designed their applied BM concepts with many well-known context-based elements (e.g., architects as peers). In turn, we assess that the practical usefulness of these high-degree BM concepts could have been high in the case of the original case firm(s). By now, this case-based evidence has been outdated and no new, recent case studies that would have tested the same concepts have been reported upon.

The same critique concerns our suggestions for the theoretical shaping of future, client-driven BM concepts along those six sub-dimensions that we have drawn from the seven highly client-driven BM concepts, respectively.

Nevertheless, it is our intent that this client-driven review would trigger a flow of *collaborative research, development, and innovation programs (R&D&I)*, i.e., (a) CIB-related and generic stakeholder-oriented researchers jointly produce highly client-driven BM knowledge, concepts, and models. Contextual contributions resemble many lines of client account thinking such as client grouping and segmentation, life-cycle management, Internet of Clients, and collaborative contracting. (b) Research entities and firms jointly carry out R&D&I programs focused on owners, investors, developers, and other root client groups vis-a-vis (inter)national business types embedded within construction markets. (c) CIB-related researchers advance management concepts that benefit public and private clients alike.

7. REFERENCES

- Anderson, D. K. and Merna, A., 2005, Project management is a capital investment process. *Journal of Management in Engineering*, 21(4), 173-178.
- Anell, B., 2000, Managing project portfolios. In Lundin, R. A. and Hartman, F. (eds.) *Projects as business constituents and guiding motives* (pp. 77-88). Kluwer.
- Arto, K. A., 1999, Management across the organisation. Editorial. *Project Management*, 5(1), 4-9.
- Barney, J. B., 2002, *Gaining and sustaining competitive advantage*. 2nd edition. Prentice Hall.
- Barrett, P., 2000, Achieving strategic facilities management through strong relationships. *Facilities*, 18(10/11/12), 421-426.
- Bartlett, C. A. and Ghoshal, S., 1989/1998, *Managing across borders – the transnational solution*. 1st/2nd edn. Harvard Business School Press.
- Bashouri, J. and Duncan, G. W., 2014, A model for sharing knowledge in architectural firms. *Construction Innovation*, 14(2), 168-185.
- Bennett, J., 2000, *Construction – the third way*. Butterworth-Heinemann.
- Betts, M. and Ofori, G., 1992, Strategic planning for competitive advantage in construction. *Construction Management and Economics*, 10, 511-532.
- Borner, R., 2004. Success factors in construction processes as a key for a benefit oriented knowledge management model. In *Proceedings of CIB World Building Congress on Building for the Future*. CIB, NRC. 1-7 May 2004, Toronto.
- Bos-de Vos, M., Wamelink, J. W. F. H. and Volker, L., 2016, Trade-offs in the value capture of architectural firms: The significance of professional value. *Construction Management and Economics*, 34(1), 21-34.
- Brege, S., Stehn, L. and Nord, T., 2014, Business models in industrialized building of multi-storey houses. *Construction Management and Economics*, 32(1-2), 208-226.
- Burgelman, R. A., 2002, *Strategy is destiny*. Free Press.
- Cheng, E. W. L. and Li, H., 2002, Construction partnering process and associated critical success factors. *Journal of Management in Engineering*, 18(4), 194-202.
- Chiang, Y.-H., Tang, B.-S. and Wong, F. K. W., 2008, Volume building as competitive strategy. *Construction Management and Economics*, 26(1), 161-176.
- Chinowsky, P. S. with Meredith, J. E., 2000, *Strategic corporate management for engineering*. OUP.

- Davies, A., Brady, T., 2000, Organizational capabilities and learning in complex product systems. *Research Policy*, 29, 931-953.
- Davies, A., Brady, T. and Hobday, M., 2007, Organizing for solutions: Systems seller vs. systems integrator. *Industrial Marketing Management*, 36, 183-193.
- Flanagan, R., 1994, The features of successful construction companies in the international construction market. In Warszawski, A. (ed.) *Etkin International Seminar* (pp. 304-318). CIB W65, NBRI, Tecnion. 8-9 June, Haifa.
- Girmscheid, G., 2010, Paradigm shift and client focus on industrialization. In Girmscheid, G. and Scheublin, F. (eds.) *New Perspective in Industrialisation in Construction. A State-of-the-Art Report* (pp. 131-137). CIB Task Group 57 Industrialisation in Construction. CIB Publication No. 329. Eigenverlag des IBB an der ETH, Zurich.
- De Haan, J., Voordijk, H. and Joosten, G.-J., 2002, Market strategies and core capabilities in the building industry. *Construction Management and Economics*, 20, 109-118.
- Hamel, G. and Prahalad, C. K., 1994, *Competition for the future*. Harvard Business School Press.
- Haugbølle, K. and Boyd, D., 2016, *Clients and users in construction. Research roadmap summary*. Publ. 408. CIB.
- Hawk, D., 1992, *Forming a new industry – International building production*. D11. Swedish Council for Building Research.
- Hawk, D., 2006, Conditions of success. *Construction Management and Economics*, 24, 735-742.
- Helander, A. and Möller, K., 2007, System supplier's customer strategy. *Industrial Marketing Management*, 36, 719-730.
- Heywood, C. and Kenley, R., 2008, The sustainable competitive advantage model for corporate real estate. *Journal of Corporate Real Estate*, 10(2), 85-109.
- Hobday, M., 2000, The project-based organization. *Research Policy*, 29, 871-893.
- Huovinen, P., 1999, A recursive competence-based approach for managing a firm in capital investment markets. In Hannus, M., Salonen, M. and Kazi, A. S. (eds.) *Procs of 2nd International Conference on Concurrent Engineering in Construction* (pp. 167-176). CIB TG33, VTT. 25-27 August 1999, Espoo.
- Huovinen, P., 2001, A framework for designing an international competitive strategy in the case of technology-intensive contractors. In Preece, C. N. (ed.) *Procs of 2nd Int'l Construction Marketing Conf.* (pp. 68-75). Univ. of Leeds. Watford.
- Huovinen, P., 2002, Managing a firm's competitiveness in global capital investment markets. In Uwakweh, B. and Minkarah, I. A. (eds.) *Procs of 10th Symposium of CIB W65&W55 on Construction Innovation and Global Competitiveness* (pp. 330-344). University of Cincinnati, CIB. 9-13 Sep 2002, Cincinnati. CRC Press, Boca Raton.
- Huovinen, P., 2003a, Firm competences in managing a firm's dynamic business in particular in construction markets. Unpublished Licentiate Thesis in Construction Economics and Management. Helsinki University of Technology.
- Huovinen, P., 2003b, Knowledge-based management of a firm's business in capital investment markets. In Ofori, G. and Ling, F. Y. Y. (eds.) *Procs of CIB W55 et al. Symposium on Knowledge Construction* (pp. 367-381). Vol. 1. National University of Singapore, CIB. 22-24 Oct 2003, Singapore.
- Huovinen, P., 2004, Organization-based management of a project business in capital-investment markets. In *Procs of NORDNET 2004 Conference on Successful PM*. PM Association in Finland. 29 Sep – 2 Oct 2004. Helsinki.
- Huovinen, P., 2005, Recursive management of a dynamic business in global capital-investment markets. In Kähkönen, K. and Porkka, J. (eds.) *Procs of 11th CIB W55, W65 et al. Symposium on Global Perspectives on Management and Economics in the AEC Sector* (pp. 142-153). Vol. 2. VTT, RIL, CIB. 13-16 June 2005, Helsinki.
- Huovinen, P., 2008, Platform for advancing research in competence-based business management: A population of 84 concepts published between the years 1990-2002. In Sanchez, R. and Heene, A., eds., *A Focused Issue on Fundamental Issues in Competence Theory Development. Research in Competence-Based Management* (Vol. 4, pp. 175-218). Emerald Group.
- Huovinen, P., 2011a, Advancement of sustainable development, contracting, design, and supply businesses vis-a-vis construction markets. In Wamelink, H., Geraedts, R., and Volker, L. (eds.) *Procs of MISBE2011 Int'l Conference on Management and Innovation for a Sustainable Built Environment*. CIB, Delft University of Technology. 20-23 June 2011. Amsterdam.
- Huovinen, P., 2011b, Managing of construction-related businesses in environmentally sustainable ways - a focused review of 62 concepts. In Wamelink, H., Geraedts, R., and Volker, L. (eds.) *Procs of MISBE2011 Int'l Conference on Management and Innovation for a Sustainable Built Environment*. CIB, Delft University of Technology, 20-23 June 2011. Amsterdam.

- Huovinen, P., 2017, Shaping future construction-related business management: A review of 77 concepts. *Procs of International Research Conference on Shaping Tomorrow's Built Environment, Construction and Design for the Modern World*. School of Built Environment, University of Salford, CIB. 11-12 Sep 2017, Salford.
- Huovinen, P. and Hawk, D. L., 2003, Towards collaborative customer-supplier relationships in global building product businesses. In Reponen, T. (ed.) *Information technology-enabled global customer service* (pp. 143-162). Idea Group.
- Jennings, M. J. and Betts, M., 1996, Competitive strategy for quantity surveying practices: The importance of information technology. *Engineering, Construction and Architectural Management*, 3(3), 163-186.
- Johansson, J. and Vahlne, J.-E., 2009, The Uppsala internationalization process model revisited. *Journal of International Business Studies*, 40(9), 1411-1431.
- Johnsson, H., 2011, The building system as a strategic asset in industrialized construction. In Haugbølle, K., Gottlieb, S. C., Kähkönen, K. E., Klakegg, O. J., Lindahl, G. A. and Widén, K. (eds.) *Procs of 6th Nordic Conference on CEO. Vol. 3* (pp. 541-552). DBRI, Aalborg University. 13-15 April 2011, Copenhagen.
- Kale, S. and Ardit, D., 2002, Competitive positioning in US construction industry. *Journal of Construction Engineering and Management*, 128(3), 238-247.
- Kaya, S., Heywood, C. A., Arge, K., Brawn, G. and Alexander, K., 2004, Raising facilities management's profile in organizations: Developing a world-class framework. *Journal of Facilities Management*, 3(1), 65-82.
- Keenan, J. M., 2016, From sustainability to adaptation: Goldman Sachs' corporate real estate strategy. *Building Research & Information*, 44(4), 407-422.
- Kendall, G. J., 2003, Profit-driven portfolios. *PM Network*, 17(5), 48-53.
- Kiiras, J. and Huovinen, P., 2004, The virtual project management (PM) services company – in the case of construction markets in Finland. In *Procs of CIB World Building Congress 2004*. NRC. 1-7 May 2004, Toronto.
- Kujala, S., Artto, K., Aaltonen, P. and Turkulainen, V., 2010, Business models in project-based firms - Towards a typology of solution-specific business models. *International Journal of Project Management*, 28, 96-106.
- Lampel, J., 2001, The core competencies of effective project execution. *Int'l J. of Project Management*, 19, 471-483.
- Langford, D. and Male, S., 2001, *Strategic management in construction*. 2nd ed. Blackwell.
- Leinberger, C. B., 1993, *Strategy for real estate companies*. Urban Land Institute and ACRE, Washington.
- Lindholm, A.-L., Gibler, K. M. and Leväinen, K. I., 2006, Modeling the value-adding attributes of real estate to the wealth maximization of the firm. *Journal of Real Estate Research*, 28(4), 445-475.
- Love, P. E. D., Li, H., Irani, Z. and Faniran, O., 2000, Total quality management and the learning organization: A dialogue for change in construction. *Construction Management and Economics*, 18, 321-331.
- Love, P. E. D., Irani, Z., Cheng, E. and Li, H., 2002, A model for supporting inter-organizational relations in the supply chain. *Engineering, Construction and Architectural Management*, 9(1), 2-15.
- Løwendahl, B., 1997, *Strategic management of professional service firms*. 1st ed. Copenhagen Business School.
- Macmillan, I. C. and Selden, L., 2008, The incumbent's advantage. *Harvard Business Review*, 86(10), 111-121.
- Meklin, J., Lahti, M., Kovanen, V., Arenius, M. and Artto, K. A., 1999, *FITPRO - A product-oriented approach to industrial project management*. PM Association in Finland, Helsinki.
- Metais, E. and Meschi, P.-X., 2005, Competence-based management and strategic flexibility: The case of Air Liquide. *Advances in Applied Business Strategy. Competence Perspectives on Managing Internal Processes*, 7, 91-107.
- Milosevic, D. Z. and Srivannaboon, S., 2006, A theoretical framework for aligning project management with business strategy. *Project Management Journal*, 37(3), 98-110.
- Mitchell-Ketzes, S., 2003, Optimising business performance through innovative workplace strategies. *Journal of Facilities Management*, 2(3), 258-275.
- Morris, P. W. G. and Jamieson, A., 2005, Moving from corporate strategy to project strategy. *Project Management Journal*, 36(4), 5-18.
- Mutka, S. and Aaltonen, P., 2013, The impact of a delivery project's business model in a project-based firm. *International Journal of Project Management*, 31, 166-176.
- Nonaka, I. and Takeuchi, H., 1995, *The knowledge-creating company*. OUP.
- Osgood Jr., R. T., 2004, Translating organizational strategy into real estate action. *Journal of Corporate Real Estate*, 6(2), 106-117.
- Pinto, J. K., Rouhiainen, P. and Trailer, J. W., 2000, Project success and customer satisfaction. In Lundin, R. A. and Hartman, F. (eds.) *Projects as business constituents and guiding motives* (pp. 103-115). Kluwer.
- Porter, M. E., 1994, Toward a dynamic theory of strategy. In Rumelt, R. P., Schendel, D. E. and Teece, D. J., eds., *Fundamental Issues in Strategy* (pp. 423-461). Harvard Business School Press.
- Rapp, R. R., 2001, Business strategy. *Leadership and Management in Engineering*, 1(April), 37-42.
- Robinson, H. S., Carillo, P., Anumba, C. J. and Al-Ghassan, A. M., 2002, Knowledge management for continuous improvement in project organizations. In Uwakweh, B. and Minkarah, I. A. (eds.) *Procs of 10th Symposium*

- of CIB W65&W55 on Construction Innovation and Global Competitiveness (pp. 680-697). University of Cincinnati, CIB. 9-13 Sep 2002, Cincinnati. CRC Press, Boca Raton.
- Rogers, P. A., 2004, Performance matters: How the high performance business unit leverages facilities management effectiveness. *Journal of Facilities Management*, 3, 371-381.
- Roulac, S. E., 1999, Real estate value chain connections. *Journal of Real Estate Research*, 17(3), 387-404.
- Roulac, S. E., 2001, Corporate property strategy is integral to corporate business strategy. *Journal of Real Estate Research*, 22(1-2), 129-152.
- Salonen, A., Gabriëlsson, M. and Al-Obaidi, Z., 2006, Systems sales as a competitive response to the Asian challenge: Case of a global ship power supplier. *Industrial Marketing Management*, 35, 740-750.
- Sanchez, R. and Heene, A., 2004, *The new strategic management. Organization, competition, and competence.* Wiley.
- Sauer, C., Liu, L. and Johnston, K., 2001, Where project managers are kings. *Project Management J.*, 32(4), 39-49.
- Singer, B. P., Bossink, B. A. G. and Vande Putte, H. J. M., 2007, Corporate real estate and competitive strategy. *Journal of Corporate Real Estate*, 9(1), 25-38.
- Tansey, P., Spillane, J. P. and Meng, X., 2014, Linking response strategies adopted by construction firms during the 2007 economic recession to Porter's generic strategies. *Construction Management and Economics*, 32, 705-724.
- Then, D. S. S., Tan, T. H., Santovito, R. and Jensen, P. A., 2014, Attributes of alignment of real estate and facilities management to business needs. *Journal of Corporate Real Estate*, 16(2), 80-96.
- Thiry, M. and Deguire, M., 2007, Recent developments in project-based organizations. *International Journal of Project Management*, 25, 649-658.
- Trejo, D., Shekhar, P., Anderson, S. and Cervantes, E., 2002, Framework for competency and capability assessment for resource allocation. *Journal of Management in Engineering*, 18(1), 44-49.
- Turner, R. and Keegan, A., 2000, The management of operations in the project-based organization. *Journal of Change Management*, 1(2), 131-148.
- Veshosky, D., 1994, Portfolio approach to strategic management of A/E firms. *Journal of Management in Engineering*, 10(5), 41-47.
- Walker, D. H. T., 2005, Having a knowledge competitive advantage (K-Adv): A social capital perspective. In Ribeiro, F. L., Love, P. D. E., Davidson, C. H., Egbu, C. O. and Dimitrijevic, B. (eds.) *Procs of Conference on Information and KM in A Global Economy* (pp. 13-31). CIB, IST. 19-20 May, Lisbon.
- Whitla, P., Walters, P. and Davies, H., 2006, The use of global strategies by British construction firms. *Construction Management and Economics*, 24, 945-954.
- Wikström, K., Artto, K., Kujala, J. and Söderlund, J., 2010, Business models in project business. *International Journal of Project Management*, 28, 832-841.
- Winch, G. and Schneider, E., 1993, The strategic management of architectural practice. *Construction Management and Economics*, 11, 467-473.

W120: DISASTERS AND THE BUILT ENVIRONMENT

UNDERSTANDING DELAYS IN CONSTRUCTION IN CONFLICT ZONES

B. Razia, N. Thurairajah and P. Larkham

Faculty of Engineering and Built Environment, Birmingham City University, The Parkside Building, 5 Cardigan St, Birmingham B4 7BD, UK

Email: Bahaa.razia@mail.bcu.ac.uk

Abstract: Delay-related issues have been identified as one of the key inhibiting factors in the construction sector due to its significant impact on project performance and completion. As the construction industry faces these problems, the understanding of delays in construction needs to be improved in order to successfully meet project goals. This study focuses on understanding delays in construction projects in conflict zones, especially in Palestine. The situation in conflict zones is affected by several parties, external to the project. How project managers identify and respond to these delays varies immensely, probably based largely on their perception of risk. This situation in conflict zones introduces a different set of delays that needs to be considered carefully. Construction projects in Palestine face a high degree of problems, especially delays, due to the ongoing and prolonged Palestinian-Israeli conflict. This research aims to identify and understand delays caused by external factors arising from the situation in conflict zones in Palestine. Because of this conflict there is a lack of large-scale construction projects such as universities, airports, shopping centres or highways. Thus this research focuses on residential projects, for which there is a high demand. Most of these delays and problems affect time, cost and quality of constructing residential projects. Initially ten targeted expert interviews were carried out in order to identify types of external delays arising from the conflict situation. Then a wider survey was conducted to understand the scale, nature and impact of each delay on construction project performance. The research identifies factors that are specific to conflict zones that cause construction delays. It concludes that limited building areas, limited water resources, segmentation of land, lack of use of technology and fluctuation in material cost are the most critical factors that lead to construction delays in this conflict zones.

Keywords: risk perception, conflict zones, delays, construction.

1. INTRODUCTION

Construction projects are complex, dynamic, and characterised by risks. Projects differ in duration, size or objectives (Smith, 2014). The problems and risks that lead to delays in the construction industry, such as implementation risks, financial risks, disputes, project abandonment, litigations, late completion, waste or cost have been widely illustrated (Doloi et al., 2012; Enshassi et al., 2009 and Ramanathan et al., 2012). Moreover, construction projects usually suffer from unique causes leading to delays, such as lack of information, design problems, changes in scope and lack of management (Shehu et al., 2014). Delays occur in all stages of construction projects, leading to time and cost overrun (Yang et al., 2010).

Vyas (2013) claimed that construction delays make project participants stressed and unfocused, because they try to avoid the effect of any potential delay by extending the project time or accelerating the project work. This leads to consequences such as cost overrun, litigations or disputes (Salunkhe and Patil, 2014).

The demand of construction stakeholders in conflict zones for delivering projects on time has required more research to identify the cause of delays. Conflict zones suffer from different kind of risks and disputes. Implementing construction projects in those zones are challenging and

risky. The risks of working in conflict zones could be posed by war, financial issues or increased operational cost (Locaria, 2013). International and some local organisations are able to perform projects in conflicts with a lack of identifying and assessing potential delays. Understanding and identifying stakeholder's perspectives about delays help construction companies to deliver projects without delays.

Previous studies found that stakeholders including contractors, clients, consultants and workers perceive and deal with construction delays differently (Sweis, 2008; Akinsiku et al., 2012). All of those studies have been conducted in normal situations. This study in contrast was conducted in a zone of prolonged conflict. Therefore, this study aimed to explore how project participants perceive and deal with construction delays in conflict zones. This is useful to help project stakeholders to understand and deal with different perceptions of project delays, and to provide useful information for international organisations who are intending to work in conflict areas.

2. LITERATURE REVIEW

Construction projects greatly suffer from risks, delays and uncertainties. One of the indicators of measuring the efficiency of delivering a project is time. According to Alaghbari et al. (2007), construction project delay is one of the most complex, costly and risky problems affecting construction projects. Assaf and Al-Hejji (2006) claimed that it is very rare to deliver construction project on time. Delivering the project according to planned schedule is considered a major dimension of project success (Rwelamilla and Hall, 1995). Gandhak and Sabihuddin (2014) defined delay as the completion later than the time agreed by stakeholders. According to Megha and Rajiv (2013), delays were defined as time overrun after planned project schedule. Client may face loss in project revenue and contractors may be exposed to cost overheads due to project delays or time extension. Yang and Ou (2008) illustrated that reducing project time and cost is important to manage construction projects and deliver them successfully. They also stated that delays can increase the project duration and occur in all phases of the project.

Ali et al. (2012) claimed that factors of delays are related to four classifications, contractor, client, consultant and external. Moreover, Assaf and Al-Hejji (2006); Theodore (2009); Motaleb and Kishk (2010); Gandhak and Sabihuddin (2014) determined the causes on project delays and classified them into three classifications; consultant, owner and contractor.

First classification, factors related to the project owner, the previous authors identified the main causes of delay as; late progress payment, variation orders, late approvals for shop drawings, lack of communication among project parties, poor coordination, late design approval, delay in decision making, conflict among project stakeholders, delay in furnishing stage and suspension of work. Second classification, factors related to project contractor, the scholars also identified the causes of construction delays as; conflict among subcontractors, rework because of errors throughout construction phase, conflict between project parties and contractor, poor coordination, insufficient plans, ineffective project schedule, inadequate construction methods, incompetent contractor, lack in technical workers experience, frequent change of subcontractor, communication problems, late site mobilization, insufficient capital and other financial difficulties. Third classification, factors related to consultant, causes of delays identified by previous scholar as; late approvals, problems in communications and coordination, inadequate experience, errors in design approvals, late in producing shop drawing, unclear information in drawing, insufficient methods for data collection and shortage

in available resources (Assaf and Al-Hejji, 2006); Theodore (2009); Motaleb and Kishk, 2010); Gandhak and Sabihuddin, 2014).

Pourrostan and Ismail (2011) claimed that delays in construction projects cause time overrun and cost overrun, conflict, litigation and abandonment of projects. Based on those results, other scholar have conducted a study in delays in construction and identified the same results (Motaleb and Kishk, 2010).

Table 1: Causes of delays in construction projects

Author \ Cause	Akintoye and MacLeod (1997)	Mezher and Tawil (1998)	Sweis et al. (2008)	Love et al. (2005)	Alaghari et al. (2007)	Shehu et al. (2014)	Jennings (2012)	Lo et al. (2006)	Ahiaga-Dagbui and Smith (2014)	Odeyinka and Yusuf (1997)	Koushki et al. (2005)	Kaliba et al. (2009)	Walker and Vines (2000)	El-Razek et al. (2008)	Hwang et al. (2013)	Mahamid et al. (2011)	Marzouk and El-Rasas (2014)	
Poor performance	✓					✓							✓					
Lack of information							✓	✓	✓									
Variation orders										✓								
Lack of experience			✓								✓		✓					
Lack of coordination among various stakeholders	✓													✓	✓			
Lack of commitment and inefficient site management	✓			✓	✓													
Poor planning and scheduling			✓				✓										✓	
Equipment unavailability								✓					✓					
Labour disputes and strikes				✓									✓					
Political issues																	✓	
Late of approvals		✓																✓

Managing risks in construction projects depends on the consensus and collaboration of all stakeholders involved in the project. Toole (2002) acknowledged that various agreements and opinions among stakeholders in construction affect a project's success. Also, Thekdi and Lambert (2014) established that consensus of dealing with risk is difficult to accomplish among people within construction due to discrepancies in understanding, perspective and expertise. Arezes and Miguel (2008) claimed that most risks in construction projects are objective and can be recognized and observed. However, Flin et al. (1996) explored that risk perceptions are subjective and varied between individuals. Hallowell (2010) also addressed an important differences in perceiving risk in construction between workers, managers and contractors. Ouedraogo et al. (2011) added that people in construction react differently to the same consequences from various risk, and accomplished that perception of risks depends on experience, culture, society, and knowledge.

Conflict means widespread violence, war crimes, armed aggression or human rights abuses (OECE, 2012). Conflict zones are defined as an area where conflict is widespread. The area

might be country, region or an area locates within more than one country. Conflict is sometimes presented as a separate ‘issue’ that can be showed in isolation from other ‘issues’ such as the environment, human rights, or sustainable development. But conflict is a cross-cutting context or theme that is related with a violent manifestation of tensions that may have produced as a results of various reasons such; unjust governance, human rights abuses, environmental scarcity or economic insecurity. Therefore, Conflict sensitivity includes consideration of the range of problems that may cause trigger or violence in the future. There is a strong relation between doing business or investment in conflict zones and conflict. There are various relations that are related to a geographical scales and a level complicity. The interactions between investment and conflict happen at all geographical scales including the closest areas to the project (investment) up to the national scale (OECD, 2016).

Perceptions of risk are partly based on actual risk which is different across various locations (Huddy et al., 2002). But, risk perception is also affected by daily difficulties and changing in behaviours. Jonas et al., (2003) found that people who live in conflict areas feel less safe and this affect their behaviours in perceiving and dealing with risks. The purpose of studying risk perception is arisen from the observation that lay people and experts often have different views and disagreed about how identifying the risks in natural hazards and technologies. Research shows that risk perceptions are greatly affected by the emotional state of individuals (Bodenhausen, 1993). According to valence theory, there is a difference between negatives emotions such as anger and fear, and positive emotions such as optimism and happiness. Positive emotions lead individuals to perceive risks positively (optimism way), however negative emotions lead individuals to perceive risks negatively (pessimistic way) (Lerner and Keltner, 2000). Scholars also found that benefit and risks are negatively related with how people think and make decision, and they are positively related with risky activities (Slovic, 2006).

Numerous researchers studied delays in construction in different areas and countries. However, there is a lack in identifying causes of delays in construction in conflict zones. Due to that, this study aims to identify causes of delays and how individuals perceive them in construction in conflict zones.

3. RESEARCH METHODOLOGY

This study was carried out in Palestine. The country suffers from prolonged armed aggression, human right abuse, difficulties in travelling, weak infrastructure, restricted boundaries and lack of financial resources resulting from the prolonged conflict (Obeidi, 2008). This study is based on qualitative and quantitative approaches in order to identify different delays in conflict zones and find their level of occurrence. Hence, qualitative approach was carried out in order to identify different kind of causes of delays and how they perceive risks. 10 experts of construction industry in Palestine have been interviewed. Prior to the interviews, experts in construction projects were chosen depending on their contribution to the project. The experts were included consultants, contractors and clients who are involved in construction. The chosen participants were contacted via e-mails and telephone in order to attain their acceptance to participate in this the interview. The participants were informed about the aim of the interview and the research aim before conducting the interview. Also, the participants were assured about the confidentiality of their answers.

A questionnaire survey was also conducted in this study. The interviews were considered as a guideline for the interview. The questionnaire were distributed among 45 construction project participants. 15 were distributed to participant associated with owner, 15 with participant associated with consultant and 15 with participants associated with contractors. 31 were returned representing a response rate of 69 percent.

The causes of delays in construction residential projects were ranked and analysed by the measurement of severity index. Moreover, the following formula was used in order to rank them according to the views of the participants.

Severity Index (S.I.) % = $\sum A (F/N) \% *100/5$, where:

A is the constant expressing weighting given to each response (ranges from 1 for very low up to 5 for very high),

F is the frequency of the responses and,

N is total number of responses.

Table 2: Severity index scale

Percentage %	Severity level
0-20	Very low
20-40	Low
40-60	Moderate
60-80	High
80-100	Very high

4. DATA ANALYSIS

The interviewees claimed that there are three different types of categories for delays which are geographic, political and generic. Also, they presented causes of delays related geographic category such as inaccessibility to the projects, poor soil suitability, natural disaster, man-made disaster, limited building areas and limited water resources.

Furthermore, causes of delays related political such as restricted construction areas, restrictions in building design, limited electricity resources, investment risks, lack of transportations and market demand problems. The problems of market demand results pf in the lack of demanding on projects in some restricted areas, because customers do not prefer to live or invest in areas which are close to problems or conflicts. So, owners find difficulties to promote their business and sell it. According to Palestinian regulations, external investors or customers are not allowed to invest, sell or buy anything in Palestine. In term of investment risks, most investors worry to investing in areas in Palestine, as these areas are exposed to high risks due to Palestinian-Israeli conflict. So, they are unsure about achieving successful project completion and benefits.

In addition, there is a lack in transportation to reach some residential hoses using public or private transportations, as some roads are unsafe to be used in conflict areas. Quantitative approach was also carried out in order to identify delays with high severity and low severity index. These causes of delays were ranked on a scale from 1 (very low) to 5 (very high).

This study shows the current views of owners, consultants and contractors in construction project in the West Bank. 19 causes of delays in construction residential projects were identified and ranked. Based on interviews results, the causes of delays were classified into three different categories which are: geographical, political and generic categories (table: 3).

Table 3: List of delays and related category

Category	Cause of delay
Geographic	Inaccessibility to the projects, poor soil suitability, natural disaster, man-made disaster, limited building areas and limited water resources
Political	Restriction in construction areas, limited electricity, restriction in movements, restrictions in construction, design, investment risks, market demand problems and limited construction areas.
Generic	Shortage in labours, shortage in experts, lack of engineers, fluctuation in materials costs, monopoly and lack of using high-technology equipment.

5. RESEARCH RESULTS AND DISCUSSIONS

Table 4 presents the severity index and ranking for each cause of delay in the geographic category. Three different types of perspectives have been considered in order to rank these causes. Contractors and consultants identified that the limited building areas cause leads to highest amount of delay. However, the owner's perspective shows the highest amount of delay is the limited water resources cause. On the other hand, the perspectives of consultants and contractors claimed that the lowest amount of delays is related to the natural disaster cause. In contrast, the owner's indicated that the lowest ranked delay is in man-made disaster cause. Also, all perspectives were identified the same ranking for the inaccessibility to the projects cause.

Table 4: Ranking cause under geographic category

Cause of delay	Contractor's perceptive		Owner's perspective		Consultant's perspective	
	Severity index	Rank	Severity index	Rank	Severity index	Rank
Difficulties in travelling	84.98	1	81.56	2	78.18	1
Limited water resources	76.61	2	80.76	1	77.15	2
Poor soil suitability	40.57	4	38.72	4	36.43	5
Natural disaster	26.12	6	29.11	5	31.91	6
Man-made disaster	31.89	5	28.64	6	37.79	4
Inaccessibility to the projects	66.78	3	51.22	3	69.55	3

Table 5 shows the severity index and ranking for each cause of delay in the political category. 7 causes causing delay were identified under this category. According to the contractor, the highest amount of delay is the difficulties in travelling. However, owners claimed that the highest amount of delay is the restricted construction areas cause. According to consultants,

restrictions in construction design is considered one of the most important factor that leads to delay in construction projects.

On the other hand, all participants suggested that the lowest amount of delays is the lack of transportation factor. Also, there are more than one factor with severity index more than 50% such as: segmentation of the land, restricted construction areas, market demands problems, investment risks and lack of transportation. This means that the political situation has a high impact on construction project completion. Thus these causes are most likely leading to delay in construction residential projects.

Table 5: Ranking cause under political category

Cause of delay	Contractor's perceptive		Owner's perspective		Consultant's perspective	
	Severity index	Rank	Severity index	Rank	Severity index	Rank
Restriction in construction areas	73.85	3	83.44	1	69.43	3
Limited electricity	48.33	6	41.31	6	51.66	6
Restriction in movements	38.84	7	31.65	7	26.58	7
Restrictions in construction design	51.63	5	47.76	5	86.71	1
Investment risks	61.18	4	68.98	4	55.67	5
Market demand problems	74.61	2	71.79	3	69.55	3
Limited construction areas	88.34	1	82.18	2	76.32	2

Table 6 presents the severity index and ranking for different causes of delay which are related to generic category. Six causes were identified and ranked by participant's views. According to contractor, owner and consultant's perspectives, the highest amount of delay is the lack of using high-technology equipment cause. While the lowest amount of delay is the shortage in labour. All participants were claimed similar information about the amount of delays in each cause, therefore the delays were ranked similarly.

Table 6: Ranking cause under generic category

Cause of delay	Contractor's perceptive		Owner's perspective		Consultant's perspective	
	Severity index	Rank	Severity index	Rank	Severity index	Rank
Shortage in labours	27.76	6	23.71	6	19.57	6
Shortage in experts	53.52	4	59.81	4	56.52	4
Lack of engineers	41.62	5	37.29	5	46.52	5
Fluctuations in material costs	79.19	2	73.96	2	68.83	4
Monopoly	72.95	3	69.49	3	65.31	3
Lack of using high-technology equipment	83.48	1	79.39	1	85.82	1

6. CONCLUSIONS

This study concludes that delays greatly affect construction projects. This study aimed to identify and understand delays in construction project in conflict zones based on different perceptions. Three types of people perception have been used in this study; contractors, owners and consultants. Interviews and surveys were conducted to identify cause of delays and then rank them. Based on the three categorises of delays, the most critical causes that lead to delay

were: limited building areas, limited water recourses, difficulties in travelling and lack of using high technology.

Conflict zones people have different perceptions of causes of delays compared to non-conflict zones. Therefore, stakeholders in construction projects in conflict zones deal with delays differently. Researchers studied construction delays in non-conflict zones and found that the most significant causes of delay are lack of information and insufficient site management. However, this study was carried out in conflict zones and identified the most significant causes of delay as difficulty in travelling, limited construction areas and lack of using high-technology equipment.

Finally, the study showed that different people perceive delays differently depending on their knowledge and their relation with the project. Most delays in construction have been ranked and perceived differently by different individual's perception. However, there are some delays were perceived and ranked similarly. The results of this study may provide useful information for managing, perceiving and responding to risk in construction projects in conflict zones.

7. REFERENCES

- Akintoye, A S and Macleod M J (1997) Risk analysis and management in construction. "International Journal of Project Management", 15 (1), 31-38.
- Alaghbari, W, Kadir, M R and Salim, A (2007) The significant factors causing delay of building construction projects in Malaysia. "Engineering, Construction and Architectural Management", 14(2), 192-206.
- Assaf, S A and Al-Hejji, S (2006) Causes of delay in large construction projects. "International Journal of Project Management", 24(4), 349-357.
- Bodenhausen, G.V. (1993) Emotions, arousal, and stereotypic judgments: A heuristic model of affect and stereotyping. *Affect, cognition, and stereotyping: Interactive processes in group perception*, 12(3), 13-37.
- Doloi, H, Sawhney, A, Iyer B and Rentala, S (2012) Analysing Factors Affecting Delays in Indian Construction Projects. "International Journal of Project Management", 30(4), 479-489.
- Enshassi, A, Mohamed, S and Abushaban, S (2009) Factors affecting the performance of construction projects in the Gaza strip. "Journal of Civil Engineering and Management", 15 (3), 269-280.
- El-Razek, M E, Bassioni, H A and Mobarak, A M (2008) causes of delay in building construction projects in Egypt. "Journal of Construction Engineering and Management", 134 (11), 831-841.
- Faridi, A S and El-Sayegh, S M (2006) significant factors causing delay in the UAE construction industry. "Construction Management and Economics", Vol. 24 (11), 1167-1176.
- Hwang, B G, Zhao, X and Ng, S Y (2013) Identifying the critical factors affecting schedule performance of public housing projects. "Habitat International", 38 (4), 214-220.
- Gandhak, P and Sabihuddin, S (2014) Stakeholders' Perception of the Causes and Effect of Construction Delays on Project Delivery-A Review. "International journal of modern engineering", 4 (2), 194-200.
- Jennings, W. (2012), "Why costs overrun: risk, optimism and uncertainty in budgeting for the London 2012 Olympic Games. "Construction Management and Economics", 30 (6), 455-462.
- Kaliba, C, Muya, M and Mumba, K (2009) Cost escalation and schedule delays in road construction projects in Zambia. "International Journal of Project Management", 27 (5), 522-531.
- Koushki, P A, Al-Rashid, K and Kartam, N (2005), "Delays and cost increase in the construction of private residential projects in Kuwait. "Construction Management and Economics", 23 (3), 285-294.
- Lerner, JS; Keltner, D (2000) Beyond valence: Toward a model of emotion-specific influences on judgment and choice. *Cognition and Emotion*. 14 (3) 473-493
- Love, P E D, Tse, R Y C and Edwards, D J (2005), "Time-cost relationships in Australian building construction projects. "Journal of Construction Engineering and Management", 131 (2), 187-194.
- Long, L H, Lee, Y D and Lee, J Y (2008) Delay and cost overruns in Vietnam large construction projects: a comparison with other selected countries. "Journal of Civil Engineering", 12 (6), 367-377.
- Mahamid, I, Bruland, A and Dmaid, N (2011) Delay causes in road construction projects. "Journal of Management in Engineering", 28 (3), 300-310.
- Megha D, Rajiv B (2013) Critical Cases of Delay in Residential Construction Projects: Case Study of Central Gujarat Region of India. 4 (4) 762-766.

- Mezher, T M and Tawil, W (1998) Causes of delays in the construction industry in Lebanon. "Engineering, Construction and Architectural Management", 5 (3), 251-260.
- Odeyinka, H A and Yusuf, A (1997) The causes and effects of construction delays on completion cost of housing projects in Nigeria. "Journal of Financial Management of Property Construction", 29 (3), 31-44.
- Rwelamila, P D and Hall, K A (1995) Total systems intervention: an integrated approach to time, cost and quality management. "Construction Management and Economics", 13 (3), 235-241
- Sambasivan, M. and Soon, Y.W. (2007) Causes and effects of delays in Malaysian construction industry. "International Journal of Project Management", 25 (5), 517-526.
- Sweis, G., Sweis, R., Abu Hammad, A. and Shboul, A. (2008) Delays in construction projects: the case of Jordan. "International Journal of Project Management", 26 (6), 665-674.
- Salunkhe A A and Patil R S (2014) Causes of delays in any construction project. "International journal of science and research", 3 (1), 544-545
- Shehu, Z., Endut, I R, Akintoye, A, Holt, G (2014) cost overrun in the Malaysian construction industry projects: A deeper insight. "International Journal of project Management", 32 (8), 1471-1480.
- Slovic, P (2006) Risk perception and affect. *Current Directions in Psychological Science*, 15 (6), 322–325.
- The Organisation for Economic Co-operation and Development OCED (2012) conflict-affected and high risk areas. Available at: <http://www.oecd.org/fr/daf/inv/mne/mining.htm> [Accessed 25 July 2016].
- Walker, D.H.T. and Vines, M.W. (2000), "Australian multi-unit residential project construction time performance factors. "Engineering, Construction and Architectural Management", 7 (3), 278-284.

W121: OFFSITE CONSTRUCTION

BARRIERS AND CHALLENGES FOR OFFSITE CONSTRUCTION IN UK HOUSING SECTOR

M. Arif¹, P. Killian², J. Goulding³, G. Wood⁴ and A. Kaushik^{5*}

¹Professor, School of Built Environment, University of Wolverhampton, UK

²Knowledge Transfer Partnership Associate, University of Salford and Manchester city council

³Professor, Northumbria University, UK

⁴Senior Lecturer, School of Built Environment, University of Salford, UK

⁵Research Assistant, School of Built Environment, University of Wolverhampton, UK

*Email: a.k.kaushik@wlv.ac.uk

Abstract: Offsite construction (OSC) has been presented by researchers and practitioners all over the world as an efficient and effective way of delivering buildings. The benefits regarding time, cost and quality are well-documented. However, it has not been successfully implemented in housing, especially in the affordable housing sector. This paper uses the case study method from the affordable housing sector to document these challenges and proposes a way forward for the sector. Also, findings indicate that the high cost of production was identified as a major barrier to the proliferation of off-site housing in the UK. However, the research found that the effective implementation of processes and practices such as Design for Manufacture and Assembly (DFMA) could reduce the likelihood of cost escalation.

Keywords: Barriers, Challenges, Modular And Offsite Construction, UK Housing Sector

1. INTRODUCTION

UK's housing shortfall has triggered a re-evaluation of the nation's approach to building. The Construction Industry Council's Off-site Housing Review (Miles & Whitehouse, 2013) and The Lyons Review (Lyons, 2014) suggest that OSC technologies should be harnessed to facilitate increases in the supply of affordable homes. However, despite the potential of off-site, the UK's attitude towards innovation in home building is relatively conservative compared to other developed economies (Nadim and Goulding, 2010). For example, the majority of houses in the UK are still constructed with brick and concrete block walls because house builders have been slow to adopt modern methods of construction. Numerous studies have attempted to examine industry approaches to off-site building methods. Edge et al. (2002) found that potential home buyers hold negative perceptions of post-war prefabricated homes and often resist any products that do not resemble a traditional house. This perception barrier can also exist among architects and designers. While perceptions are important, Venables et al. (2004) suggest that the views of developers partly influence off-site manufacture and partly by wider market and regulatory factors. Technical difficulties such as site planning, logistics, and a fragmented supply chain can also inhibit the acceptance of OSC among industry professionals (Pan, Gibb & Dainty, 2007). These implementation issues were the focus of a 2012 study for the International Council for Research and Innovation in Building and Construction (CIB). A report by the World Energy Council (2013) estimates that up to 40% of the cost of a building is incurred through in-house energy consumption and maintenance. A study by McGraw-Hill Construction across a range of disciplines found that off-site can reduce defects, shorten delivery times, and provide a safer, more environmentally friendly mode of building (McGraw-Hill, 2011). A team of leading Off-site academics led a series of workshops with housing industry practitioners who identified that off-site building represents a new paradigm, and therefore different approaches to 'design, manufacture, and construction' are required to

achieve optimal outcomes (Arif, Rahimian, & Goulding, 2012). Also, a previous study by Goodier and Gibb (2007) found that the additional cost of OSC compared to traditional construction severely restricts UK off-site housing developments. Therefore, barriers relating to cost, perception, and implementation may be inhibiting the growth of OSC as modern methods of construction are not yet a significant feature of the UK homes market. The purpose of this paper is to look at offsite and present lessons learnt from two case studies of implementation of offsite construction in the housing sector. The rest of the paper has five more sections. The next section presents an overview of offsite construction. It is followed by a section on research methodology and then case study is presented. Fourth section presents research findings and last section outlines the conclusions of this paper.

2. OFF-SITE CONSTRUCTION

The use of prefabrication techniques in the UK can be traced back to the Industrial Revolution: London's Crystal Palace, built in 1851, is one well-known early example of OSC. Off-site can also be rapidly deployed to meet the needs of growing demand and resource scarcity. OSC harnesses practices from the manufacturing sector; this has included utilizing the advantages of the assembly line and mass production. The resulting benefits are often improvements in quality and productivity. Over the last twenty years, numerous state-funded reports have called for efficiency gains in the UK construction industry, including the government's Construction 2025 Paper (HM Government, 2014), which continues the themes discussed in the frequently cited Egan (1998) and Latham (1994) reports. OSC could potentially be used to tackle many of the shortcomings of the British construction sector. In summary, it is clear that off-site can offer many tangible benefits to clients. There are a series of options available when implementing off-site: for instance, panellist, volumetric, hybrid, and manufactured components. The hybrid methodology is commonly employed during the construction of multi-storey developments in the form of a prefabricated concrete building core. It can significantly speed up the construction process. However, research conducted by McKinsey (2015), highlighted that this method could not be used to deliver the full advantages of OSC as it does not represent a fully industrialised approach to building. For a complete manufactured solution, constructors can turn to the volumetric method: the assembly of three-dimensional modules within a factory, which are then delivered to the site. In a similar fashion, panelled building constitutes the production of separate sheets in a controlled environment that are assembled on-site to build a three-dimensional structure.

A chart was developed by the UK National Audit Office (NAO, 2005) using data supplied by the University of Salford. Despite the findings above, it highlights that the volumetric approach is advantageous regarding speed (Figure 1). For landlords such as housing associations, the shorter build duration of a volumetric scheme could enable the early receipt of rental income, or be utilised to deliver urgently needed housing. Furthermore, a recent study has shown that in addition to compressing time spent on site, housing developers in the UK have reported significant reductions in building defects through the use of off-site methods. Table 1 presents a summary of the primary improvements off-site can deliver over conventional construction and the resulting benefits to the house builders and clients.

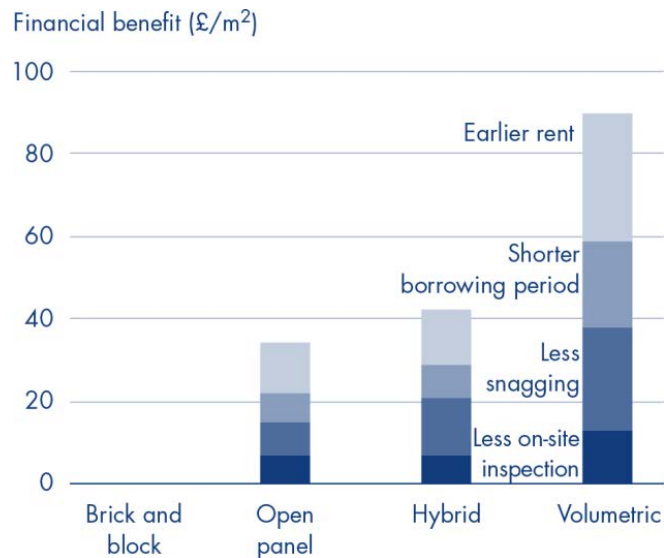

Figure 1 Economic advantage of off-site methods over traditional construction (NAO, 2005)

Table 1 Summary of the benefits of off-site for clients (Miles & Whitehouse, 2013)

Issue	Improvement Over Conventional Construction (Estimated)	Benefit to society	Benefit to house builder
Faster Construction	Up to 80% time compression on site	Significant	Large (reduced construction financing costs)
Fewer Defects	Up to 80%	Small	Significant

The advantages of prefabrication are not restricted to the short term benefit of improved delivery speed. There is evidence to suggest that off-site can be used as a tool to address environmental concerns. The research of Miles and Whitehouse, (2013) found that transferring onsite activities to the factory can reduce material waste by up to 90%. Furthermore, the energy used in site traffic movement can be reduced by up to 70% because fewer deliveries are required during the construction period. However, arguably their most significant finding is that building lifecycle energy usage can be cut by 20%. These improvements are achieved through improved insulation and a tighter building enclosure. Therefore, it is clear that off-site methods can offer substantial environmental benefits over the long term. Building life-cycle energy use is considered a salient issue in the UK. In 2010 when the British Government decided to implement amendments to the national building regulations part L (HM, 2014) to tighten the energy performance criteria for new homes.

OSC can also address challenges relating to social sustainability. Lu (2009) contends that the increased productivity resulting from controlled and predictable off-site working methods attract investors. In turn, investment in technology implies increased opportunities for training, which can help address the UK's skills gap. A further benefit of implementing OSC is that it can facilitate improved safety standards during a project. A safer working environment can be achieved through the assembly of components in a controlled factory environment. Industrialisation also reduces labour requirements and therefore can restrict site congestion and noise; this can be of significant benefit for client's constructing new housing projects within

existing high-density residential estates. Furthermore, the use of modular technology limits activities at elevated levels such as traditional roof building.

A reduction in people working at height can lower the likelihood of hazardous falls, the primary cause of fatalities in the UK construction industry throughout 2013-2014. Therefore, off-site methods can be implemented by clients as part of their health and safety strategies in order support efforts to ensure project risks are kept as low reasonably practicable. Despite these benefits, the uptake of offsite in the housing sector within the UK has been low. To investigate this low uptake, this research will present two case studies and understand the reasons for effective implementation of offsite in the UK. These reasons could be used to formulate a way forward.

3. RESEARCH METHODS

To examine current approaches to UK off-site home commissioning, the practices of off-site construction, were applied to two case studies. Yin (2013) defines case research methods as empirical inquiries that investigate subjects in a real-life context, where boundaries are not clearly defined and multiple evidential sources can be analysed. Case studies can be explained as a focus on a small volume of scenarios, as opposed to a large population of samples (Stake, 1980). Because there is a lack of recent samples of affordable UK Off-site scheme, this approach offers a practical solution. Case methodology is also useful for assessing qualitative variables such as perception and motivation, salient qualitative factors in Off-site implementation.

The method of data collection was a semi-structured interview. This approach offers the opportunity to probe for honest and in-depth responses (Gray, 2013). Furthermore, open questions were employed to extract motivations and reasoning behind actions taken. For the purpose of the study, one recent off-site project from three separate housing associations was selected. The organisation chosen specialise in the commissioning of affordable homes and are registered providers of social housing in the UK. They also have charitable status registered in England and Wales with the FSA as Industrial and Provident Societies, and they are regulated by the Homes and Communities Agency. One person from each association was interviewed regarding the projects that we shall name A. A representative of each manufacturer supplying the homes was interviewed to corroborate the views of the clients. All projects reviewed were part self-financed and part-financed by HCA government grants.

The housing association interviews took place at the participant's place of work, and the manufacturer interviews were conducted by telephone. It took between forty minutes to one hour to conduct each meeting. Each interviewee was informed of the significance of the study and that the commissioning of the projects was the unit of analysis. According to Oppenheim (1992), prompting can lead to interview bias. The participants were allowed to expand upon their answers without much restriction. Additionally, they were asked to put forward any designs, plans, or photographs documenting the projects. Issues about ethics and safety were given much consideration during the planning and undertaking of this study. The next section presents the case study.

4. CASE STUDY

Case A was undertaken by an organisation which is a social landlord with a stock of over 19,000 properties in the Midlands and the North West of England. It specialises in housing development and construction, and it operates a property repair, maintenance, and improvement division. The group employs approximately 1000 people and works in partnership with some external partners to provide its services.

The organisation first explored off-site housing when a prefabricated bungalow they owned needed replacing due to its poor condition. The property was situated on a sloping site within a small residential cul-de-sac. A winding main road, which was narrow in section, provided access to the nearest motorway located at a distance of five miles. The client perceived that selecting a modular solution for this project would cause less disruption to the surrounding residents.

Following the initial project inception, Organisation A was approached by a consortium of firms offering modular homes. The consortium consisted of three companies: a developer, a manufacturer, and an architectural firm. Company A had already worked with the architect on previous housing schemes. However, they were not familiar with the manufacturer and decided to conduct an initial assessment of the company. The management team took a visit to the factory and was impressed by the facility and the pilot house on display. The analysis of pilot house reported that timber used was of higher quality than timber used by Organisation A's projects. The visit also confirmed that the new homes would be covered by a National House Building Council approved warranty.



Figure 2 Completed Modular build development

The architect reported that lack of supply chain accountability would lead to difficulty in arranging the design warranties. The selected architects had a decade of experience in modular school buildings. They were aware that this project required modular design approach (design for manufacture). Despite the architect's experience, there were some design specification issues that were not overcome. The buildings were not designed to allow for water connections to enter the property. Once on site, the water board needed to drill through the property which could have affected the airtightness of the building envelope. The architect used BIM

technology and manufacturer used existing software. It led to some minor difficulties in design information transfer.

A change in ground conditions during the early stages of the scheme led to change from strip foundations to piles foundations. Following completion of the groundwork, the modules were delivered to the site. The manufacturer was responsible for arranging the transportation, assembly, and escorts. Due to space constraints and leveling up delays by assemblers, a decision was taken to unload the house and level them later. All the shipping and assembly was completed within two days and the rate of progress increased on the second day because of the lessons learnt on the first day. In total, the project took the same time as a traditional build, which was longer than expected. However, this extended duration was mainly down to the groundwork changes and the demolition of the existing properties. Additional site issues included a problem with a plastic lining that covered the side of the house. It was expected to easily compress with pressure but it did not and caused a small gap, and therefore some alterations were required. Despite the site issues, the quality of the final product exceeded the client expectations, especially in the area of timber frame quality and insulation (figure 2). In addition, no health and safety incidents of concern were reported during the construction phase. After the handover, the residents gave positive reports for the new houses and reported no problems. The delays experienced during the construction phase caused the project costs to rise; however, the supply chain absorbed these costs due to a single price agreement between client and principle contractor. The use of standard design and build form of contract meant that all project deliverables would be completed for the association at a set price, which would only change under a certain set of circumstances. On reflection, much of the risk was passed to the subcontracted main contractor, who then struggled to make the project profitable. This lack of profitability may have caused the subcontractor to reduce expenditure towards the end of the project, similar to traditional construction sector. The financial difficulties and loss on the scheme led to strained relationships between the supply chain partners. The ineffective coordination of service connections on-site was blamed on the confusion caused by the number of firms in the supply chain. Moreover, the client observed that the principle contractor developer became less active once work started on-site, leaving most of the responsibility with the main building subcontractor, which may explain the difficulties this firm later experienced. However, it was acknowledged that the principle contractor developer played a key role in getting the project off the ground and presenting a viable and attractive offering to the client.

5. RESEARCH FINDINGS

One important element for the client analysed in this study is that they decided upon a modular solution in the early stages. The organisation recognised that a fully industrialised approach could introduce greater efficiency to the building process and improve the product quality. One of the key drivers for the organisation to select offsite was the construction skill shortages (BIS, 2013). Another reason for using offsite was to minimise the disruption to neighbours. The plot's suitability for modular construction did not seem to play a part in their decision-making. The potential for high speed of delivery was not considered when making the selection of offsite. As social landlords, this could facilitate the early receipt of rental income (a relevant consideration for social landlords). It could either be because these features were judged to be of negligible benefit or that these advantages were not fully appreciated and factored into the proposal. Furthermore, the clients were not significantly influenced by issues of sustainability, which may be considered to be of lower priority, or it could be because they are satisfied that the majority of products on offer meet the required regulatory levels. The study indicates that

client may have also overlooked capability assessment. There was no capability assessment of internal staff and client relied on some evidence of off-site knowledge.

The major modular construction benefits realised in the case study are quick delivery speed and less impact on the site. The projects on existing housing estates could benefit a lot from modular construction. It reduces the impact of the development on current residents. Another lesson learnt was to review the supply chain assessments before taking a final decision in the commissioning phase. The client assessed the homer supplier's factory and pilot product. However, the similar assessment was not done focusing architect and subcontractors skill set in modular construction. The early engagement of the design team and focus on DFMA helped to solve some problems at the beginning of the project. Organisation's designers were experienced with off-site projects and took it upon themselves to engage with the manufacturer early in the process. King, Knight, & Griffith (2001) argue that cohesion between designer and constructor reduces the potential for a lack of coordination within the supply chain. Despite early engagement between designer and manufacturer on the project, not all issues were unavoidable. The success of modular construction relies on the adaptability of complete industrialised process approach and efficient communication between the project partners.

6. CONCLUSIONS

This project suffered due to the half-hearted adoption of modular methods and limited communication between delivery partners. This project experience highlights the importance of assessing the supply chain's capability and experience in modular and offsite construction. It is still a relatively new approach, and building sector is still adapting to the new techniques and processes. There are numerous benefits of modular construction but can only be realised if it is implemented with a capable team with modular construction knowledge, a fully industrialised and integrated process from the beginning along with client's leadership in modular construction adoption. The project would have benefited by using a more integrated approach in supply chain and design management. Team suffered due to lack of integrated communication and it could be improved using integrated design and build process approach. The future studies on offsite construction in the housing sector can be focused on analysing the degree of adoption of industrialised process in the of modular construction projects.

7. ACKNOWLEDGEMENT

This research is supported by Innovate UK and Manchester City Council under the Knowledge Transfer Partnership project (KTP009892) in collaboration with University of Salford.

8. REFERENCES

- Arif, M., Goulding, J., & Rahimian, F. P. (2012). Promoting offsite construction: Future challenges and opportunities. *Journal of Architectural Engineering*, 18(2), 75-78.
- BIS. (2013). UK Industry Performance Report. Retrieved from http://www.constructingexcellence.org.uk/pdf/KPI_Report_2011.pdf.
- Eagan, J. (1998). *Rethinking Construction*. London: Stationary Office.
- Edge, M., Craig, A., Laing, R., Abbott, L., Hargreaves, A., Scott, J., & Scott, S. (2002) *Overcoming Resistance to Prefabrication and Standardisation in Housing*. Aberdeen: Robert Gordon University.
- Goodier, C., & Gibb, A. (2007). Future opportunities for offsite in the UK. *Construction Management and Economics*, 25(6), 585-595.

- Gray, D. E. (2013). *Doing research in the real world*. Sage.
- Health and Safety Executive. (2014). *Health and safety in construction sector in Great Britain 2014/15*. London: HSE. Retrieved from <http://www.hse.gov.uk/statistics/industry/construction.pdf>
- HM Government. (2014). *Construction 2025*. London: Stationary Office.
- King, A. P., Knight, A. D., & Griffith, A. (2001). Understanding the dynamics of novation: a contractor's perspective. In: Annual ARCOM Conference, 5-7 September 2001, Salford, UK. *Association of Researchers in Construction Management*, 1(1), 951–9.
- Latham, S. M. (1994). *Constructing the team*. HM Stationery Office.
- Lu, N. (2009). "The current use of offsite construction techniques in the United States construction industry." *Seattle, Washington*, 96-96.
- Lyons, M. (2014). *Mobilising the nation to build the homes our children need*. London: Labour Party.
- McGraw-Hill (2011). "Prefabrication and modularization: Increasing productivity in the construction industry." *Smart Market Report*.
- McKinsey Global Institute. (2015). *The global affordable housing challenge*. Retrieved from http://www.mckinsey.com/urbanization/tackling_the_affordable_housing_challenge.
- Miles, J. & Whitehouse, N. (2013). *Offsite Housing Review*. London: Construction Industry Council.
- Nadim, W., & Goulding, J. S. (2010). Offsite production in the UK: the way forward? A UK construction industry perspective. *Construction innovation*. 10(2), 181-202
- National Audit Office. (2005) *Using Modern Methods of Construction to Build Homes more quickly and efficiently*. London: Stationary Office
- Oppenheim, A. N. (1992). *Questionnaire design, interviewing and attitude measurement*. London: Pinter Publishers.
- Pan, W., Gibb, A. G., & Dainty, A. R. (2007). Perspectives of UK house builders on the use of offsite modern methods of construction. *Construction Management and Economics*, 25(2), 183-194.
- Stake, R. E. (1980). *Seeking sweet water: Case study methods in educational research*. New York: American Educational Research Association.
- Venables, T., Barlow, J., and Gann, D. (2004). "Manufacturing Excellence-UK Offsite Capacity." *Innovation Studies Centre, Imperial College London*, 62pp.
- World Energy Council, W. E. (2013). "World energy resources." *World Energy Council*, London.
- Yin, R. (2013). *Case study research: Design and methods (1st ed.)*. Beverly Hills, CA: Sage Publishing.

OFFSITE MANUFACTURING IN ARCHITECTURE ENGINEERING AND CONSTRUCTION: AN UNFOLDING STORY

J.S. Goulding¹, F. Pour Rahimian², M. Arif³, A. Akintoye⁴ and I. Faraj⁵

¹ *Department of Architecture and Built Environment, Northumbria University, Newcastle, NE1 8ST, UK*

² *Department of Architecture, University of Strathclyde, 75 Montrose Street, Glasgow G1 1XJ, UK*

³ *School of Architecture and Built Environment, University of Wolverhampton, Wolverhampton, WV1 1LY, UK*

⁴ *School of Built Environment and Engineering, Leeds Beckett University, City Campus, Leeds, LS1 3HE, UK*

⁵ *Business School, Manchester Metropolitan University, Oxford Road, Manchester M15 6BH, UK*

Email: jack.goulding@northumbria.ac.uk

Abstract: Offsite manufacturing continues to make a significant contribution to the market. However, progress and inertia has been somewhat parochial, fragmented, and unmanaged. Whilst several success stories can be cited, there are no real mechanisms for identifying conjoined (integrated) solutions, especially on: socio-political and cultural drivers; societal, economic and business needs; or governmental support mechanisms. A cogent international research strategy is now needed which directly addresses these issues. This paper presents a series of offsite manufacturing developments within Architecture Engineering and Construction. Findings from several influential papers and reports were used to establish a set of priorities, the results of which were cross analysed with a panel of 11 domain experts drawn from CIB W121 (Offsite Construction) community for reflection and future direction. Research findings place significant insight into the need for embedded solutions, in particular: 1) future direction opportunities; and 2) the need for a conjoined alliance of expertise (advisors, researchers, clients, developers, designers, contractors, manufacturers, suppliers, and governmental bodies) to all work together. Whilst both proponents and dissenters will argue that this vision is somewhat ‘Utopian’, the authors proffer that transparency and consistency of message are fervent vehicles for increasing awareness and promoting the sector for future uptake.

Keywords: Design, Integration, Offsite Manufacturing, Process, Strategy

1. INTRODUCTION

A number of definitions exist for describing the offsite market; these include modularisation, offsite production and manufacture, volumetric, hybrid, panellised, preassembly, modern methods of construction, industrialised building systems etc. Whilst some of these terminologies are interchangeable, precise delineations are available in extant literature (Gibb, 1999; Pan *et al.*, 2007); to avoid confusion, the term Off Site Manufacturing (OSM) will be used throughout this paper as an all-encompassing ‘umbrella’ caveat.

Offsite production and manufacture continues to make a positive contribution to both industry and society. However, as a sector, market share and growth has been stifled by intransigent barriers associated with socio-political and cultural drivers, underpinned by changing societal, economic and business needs. Given these, a concerted drive is now needed which more purposefully presents and defends this market to the sector as a whole. In particular, there is a need to define a cogent international research strategy which directly addresses design, production and business models theories within the wider context of the industry and supportive supply chain (Goulding and Arif, 2013). Moreover, understanding the precise contribution of offsite to the market “...is critical for measuring, benchmarking and determining the growth and diffusion of innovative construction techniques” (Taylor, 2010), especially when considering risk and uncertainty (Arashpour *et al.*, 2016).

2. OSM DEVELOPMENTS AND DIRECTION

The OSM market is steadily being adopted in both developed and developing countries. Whilst adoption, absorption and diffusion levels vary from country to country, there are systemic (recurrent) challenges associated with uptake and greater widespread use. Some of these issues are context-specific, but some are more deeply engrained in cultural systems. Notwithstanding these factors, OSM has been proffered as a viable solution for procuring quality ‘affordable’ solutions to bespoke and niche areas of the market, including: housing, hotels, prisons, schools etc. Given these challenges, OSM has been acknowledged as being able to comply with changes in environmental and sustainability criteria; where for example, the Construction Industry Council (CIC) in the UK noted additional benefits (over traditional approaches), including: higher sustainability standards; better build quality; faster speed of delivery; improved construction health and safety; enhanced energy-in-use; lower whole-life carbon footprint; reduced transport pollution (CIC, 2013).

2.1 OSM uptake

The uptake of offsite manufacturing from one country to another varies considerably. Anecdotally, one of the factors which influenced (and to some extent is still influencing) the UK’s perception of OSM was founded on the early attempts to produce prefabricated buildings to deliver housing shortage post World War II (predicated through the Housing Temporary Accommodation Act 1944). This provision had a design lifespan of 10 years. Consequently, the overall quality of this temporary housing provision suffered in some instances. Somewhat ironically however, there are several of these prefabricated homes still in existence today. Earlier initiatives in offsite started around 1837 where prefabricated homes were imported from the UK, USA and Singapore to Australia. The North American market later saw the development of the “Sears Modern Homes” circa 1908 (which used a ready to assemble approach or “kit house”), and post 1945 with the development of the “Lustron home”.

More recently, OSM has shown steady growth across a number of principal markets – particularly in Japan, Malaysia, USA, UK and Australia. However, the overall percentage of offsite construction compared with more traditional construction approaches is still rather low: around 6-7% in the UK (Taylor, 2009; KPMG, 2016), 7% in the USA (HAC, 2011). Of particular interest is the converse of this in places like Japan (Barlow *et al*, 2003). Whilst the higher percentage uptake (and demand) in Japan may be linked to other factors - for example, the provision of extended warranties; the overall impetus and growth in OSM seems to be growing due to “lessons” learned from more mature markets including the Scandinavian countries. This may be due to several interrelated factors, not least: new quality thresholds, improved customer perception, the introduction of governmental support initiatives, and through the success of various high-profile case studies espoused in extant literature. Other exemplars of note include issues where standards and codes have been designed to regulate manufactured housing design and construction in the USA (see the Manufactured Home Construction and Safety Standards Act in the USA in 1976, 42 U.S.C. sections 5401-5426, also referred to as the HUD Code). Similarly, influential reports in the UK such as Egan (1998) and the Offsite Housing Review (2013) noted the importance of further investing in offsite as a viable business opportunity. Moreover, the Australian manufactured housing market has been acknowledged as being a major part of development plans (Hampson and Brandon, 2004; Blismas, 2007); and OSM in Malaysia (through the Construction Industry Development Board) has now firmly established formal legislation for offsite provision - supported by an

Industrialised Building Systems Centre (CIDB, 2015). Finally, the offsite sector in China is also developing at a steady rate, with several opportunities being evidenced (Arif and Egbu, 2010).

2.2 Skills, technology and manufacturing requirements

From an OSM perspective, the development of skills within an organisation to support offsite is probably one of the most important issues needed (to deliver the core business). Skills are often seen as a key company differentiator – the competence of which is also often referred to as “intellectual capital”. It is therefore important to appreciate that these are new skills (more often than not), which will need to be constantly updated in line with changing business imperatives. The potential of moving from a traditional ‘construction’ environment, into one which embraces offsite manufacturing will therefore require a paradigm shift in thinking, along with a transition strategy to acquire these new skills, especially as OSM has different processes, technologies and production techniques (Nadim and Goulding, 2011). Moreover, the roles and responsibilities of different parties need to be fully embraced and understood (NHBC, 2006). For example, within an advanced manufacturing environment, emphasis tends to be placed on mechanisation, robotics, logistics, handling, quality control etc. Reliance on skills is ostensibly contained (and controlled) within this sector-specific silo. Similar analogies apply in the design and construction sectors. Given this, a number of attempts to provide OSM training in such areas as new manufacturing concepts and processes include the Building Management Simulation Centre (de Vries et al, 2004), the ACT-UK Simulation Centre (Soetanto, 2010), and bespoke virtual reality simulators focussing on offsite (Goulding et al, 2012). However, there is still a general perception that there is a “...general failure among training providers to keep pace with technological change within the industry...” (McGuinness and Bennett, 2006); which from an OSM perspective is concerning, given that there is an intrinsic need to understand how Design for Manufacture and Assembly (DfMA) affects project delivery, let alone appreciate what skills are needed to support new technical developments such as Building Information Modelling (BIM).

The construction industry (compared to other industries) has not yet fully utilised advanced technologies for OSM – particularly for information flow, materials and labour management, waste etc. These limitations are well known. Tangentially, further advances are also still needed in virtual prototyping systems, as these are still not ‘smart’ enough to cope with the increasingly complex and dynamic nature of construction projects (Tah, 2012). Whilst, some would proffer that design, construction and manufacturing are becoming more intelligent, integrated and automated (Akintoye et al, 2012), and BIM also seems to offer many potential technological solutions, especially where it additionally supports construction information at various stages of the project lifecycle (Gu and London, 2010); there is still a caveat of caution to apply. Consider for example, the overall premise and functionality of BIM stems from having an open interchange of information across platforms including a transferable record of building information throughout the life cycle of a building (Isikdag et al, 2012). This technology allows the project team to plan every single aspect of a building; but, the ultimate success of BIM depends on its ability to capture all relevant data in the BIM model, and to successfully exchange data between different project participants (Nawari, 2012).

2.3 Knowledge gap and future direction of travel for OSM

From an entry to market perspective, OSM presents a raft of challenges and opportunities for new entrants. These challenges can deter some organisations from making the transition to OSM due to the perceived changes needed to infrastructure, the level of change required, and the level of investment required to make this happen. Blismas *et al* (2005), categorised these constraints into four main areas: 1) process 2) value 3) supply-chain and 4) knowledge constraints. Consider the first area of “process”; where Winch (2003), noted the importance of considering the models of manufacturing in the construction process. Cost and value are also key learning points here (Thuesen and Hvam, 2011), so is combining the strengths of the modular approach with lean construction to improve sustainability (social, environmental, economic etc.) with tangible outcomes (Nahmens and Ikuma, 2012).

The main concerns centre on niche provision, or more specifically, product differentiation (to meet market demand). OSM can leverage several benefits, not least: a higher speed of construction, improved quality, lower costs and lower labour requirements on-site. The real challenge however is to acknowledge how best these business processes can be integrated at the organisational level (Pan *et al*, 2012). Holistically, this requires a detailed appreciation of three interconnected areas: People, Process and Technology – across the remits of Design, Construction and Manufacturing (Figure 1).

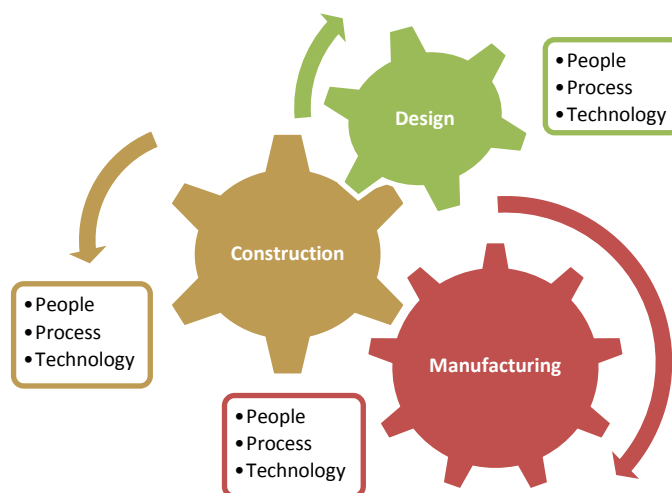

Figure 1 Design, Construction and Manufacturing Dimensions (Goulding and Arif, 2013)

Given these three interconnected areas and remits, from a challenge perspective, if offsite production and manufacture is to make a positive contribution to both industry and society, additional research is needed to identify the main pivotal issues and priorities. There is also a real need to present a cogent international research strategy which directly addresses design, production and business models theories within the wider context of the industry and supportive supply chain.

3. RESEARCH METHODOLOGY

From a research lens perspective, the three areas and three remits identified by CIB Task Group TG74 “New Production and Business Models in Construction” (Goulding and Arif, 2013) were

adopted as a founding ontology to shape thinking – especially cognisant of replicability and generalisability. Findings from this report and research roadmap highlighted the need to undertake additional work to further evaluate these parameters in line with market demand (and maturity), innovation opportunities and emergent priority themes. Acknowledging that these findings are now approximately four years old, the impetus for this research was therefore to evaluate these existing nine (3x3) parameters again in order to determine an updated set of priorities (and direction of travel) for OSM.

3.1 Research methodological considerations and approach

From an epistemological perspective, a constructivist approach was adopted, as it was considered important to reflect upon the paradigms underpinning this challenge and concomitant knowledge gap. Whilst there is an inherent danger of inviting researcher bias and “a priori knowledge”, subsequent interpretation of data would be placed on the interpretation of construct links and dependences (to ‘represent’ social realities), rather than negotiating or determining outcomes potentially laden with researcher bias/skew. Thus, neutrality and objectivity influenced the choice of methodological approach adopted. In doing so, eleven (11) domain experts were selected (purposive sampling) from a database of OSM ‘experts’ held by CIB W121 (Offsite Construction) – see <http://www.cibworld.nl/site/commissions/index.html>, and supported by W121 workshop members to ensure this sample set was representative. Respondents represented the following countries: Australia, Egypt, Hong Kong, Norway, Russia, Sweden, The Netherlands, UK, and USA. Respondents were asked to evaluate the nine parameters (Table 1) against one priority timeframe only, namely: A (0-5 years), B (6-10 years), or C (11-15 years). A Focus Group (workshop) approach was adopted to elicit primary data. This was considered particularly appropriate given the need to capture metadata and technical OSM semantics.

Table 1 Nine OSM Parameters

Design/People	Manufacturing/People	Construction/People
Design/Process	Manufacturing/Process	Construction/Process
Design/Technology	Manufacturing/Technology	Construction/Technology

The underpinning rationale and data supporting these parameters can be seen in Table 2.

Table 2 Underpinning Data Supporting the OSM Parameters

Design/People	Traditional v non-traditional - new ways of working require new skills (esp. product modelling.), new thinking, greater collaboration, reassessment of discipline areas. Design For Manufacture and Assembly is an important part of this, along with logistics integration into the design process.
Design/Process	Adding value to the business process (multiple perspectives); Process Protocol – lifecycle processes, tried and tested (most important ones); stakeholder analysis, impact of design and process (with business and technology)
Design/Technology	Technology embedded in the product (in the factory); technology underpinning the business process; e-readiness of

	organisations (and the supply chain); BIM for offsite (product and process).
Manufacturing/People	Multi-disciplinary or interdisciplinary? Mind-set training needed. Decisions have to be modelled in an integrated way (incorporating risk etc.) Shop floor approach needs to change. Benefits need to be made clear. Mass customisation, job roles and functions need re-defining.
Manufacturing/Process	Procedures need to be defined to cope with variables. Need to look at other industries re. their business models (not just efficiency over productivity, but also pre and post occupancy). Integration of suppliers into companies needed (and teams). What to adopt? e.g. automation v non-automation (is there a happy medium?). Flexibility needed (variable product line).
Manufacturing/Technology	Justifiable automation - how much is enough? (optimisation, business case, payback etc.); product and process design – DfMA (software and systems development, DSS, integrated product delivery etc.); supply chain management – MRP & ERP expensive (inflexible and somewhat limited); modelling and simulation – training needed (systems analysis, discrete event simulation and modelling etc.)
Construction/People	Up-skilling of personnel (this would require training/investment). Sustainability - social benefits, continuity of employment, economic - stable and long term employment, transportation etc. Productivity - greater efficiency and productivity, no weather disruptions etc. Triple bottom line approach.
Construction/Process	Business models – which ones? what remit? How can integration be achieved? (through RFID?). Performance of process - hard data needed (CBA etc.). Flexibility needed with elements of standardisation (economies of scale).
Construction/Technology	Need to understand what information is created, used and exchanged (Product Modelling Ontology, W3C etc.) - common tools from different vendors (integration and interaction). Understating risk (product/process). New product/processes in new application areas?

Finally, respondents were asked to rank ten OSM areas in order of priority, where 1 = most important, and 10 = least important. These ten priority areas can be seen as follows:

- A. Process Improvement
- B. Innovation (competitive advantage)
- C. Technology (BIM, new tools, big data etc.)
- D. Visualisation and Integration (through current/emerging digital technologies)
- E. Production and Process Models
- F. Strategic and Operational Business Models
- G. Training and Development

- H. Sustainability (as key a USP)
- I. Value (through life – customisation, change in use etc.)
- J. Materials (skins, retrofitting, smart components etc.)

4. RESEARCH FINDINGS

The following sections provide an overview of results garnered from the Focus Group sessions. These findings are contextualised against the nine parameters and ranking factors for OSM priority areas.

4.1 Focus study results

Design/People

91% of respondents noted there was a need to place this into Category A, as there was a need for new skills (new ways of working require new skills e.g.. product modelling, new thinking, change in individual/company behaviour etc. 61% thought that this needed to be in Category A as a new approach to design was needed, especially for suppliers, assemblers, transport operations etc. Similarly, 73% thought that this needed to be in Category A to support DfMA, along with logistic integration into the design process.

Design/Process

100% of respondents thought that this needed to be placed in Category A, as there was a real need to define business value on core business processes. 55% of respondents chose Category A to support lifecycle process analysis - including stakeholder analysis. 73% chose Category A because of the need to understand the impact of design and process (with business and technology).

Design/Technology

55% of respondents chose Category B, as they considered that technology to support products in the factory took priority. However, 73% chose Category A when technology actually underpins the business process - as it has a direct impact on supply chain partners. This resonates with 100% of respondents who chose Category A when considering such issues as BIM for offsite (product and process).

Manufacturing/People

73% of respondents chose Category A, as there was a direct need to understand the impact and effectiveness of training – viz a mind-set change (to look at projects rather than products). 55% chose Category A concerning the need for manufacturing decisions to be modelled in an integrated way [incorporating risk]. A ‘shop floor’ approach was suggested which highlighted clear benefits. However, 45% of respondents selected Category A on the basis of a need to promote mass customisation. This not only includes service parts (to address markets), but also alignment to job roles and functions (integrating people into the model).

Manufacturing/Process

55% of respondents selected Category A as their primary choice, stating the need to define procedures and variables, especially as a “one-size-fit” model was unfeasible. Moreover, there was also a need to learn from other industries in this respect, and not to focus exclusively on

efficiency or productivity. 64% chose Category A based on their desire to create a new business model for OSM [and what would this look like]. However, 64% chose the Category B timeframe in order to fully understand the break-even point for automation/non-automation as this is rather complex, including not least factors associated with lease/purchase decisions and volumetric parameters.

Manufacturing/Technology

64% of respondents selected Category B as their preferred choice. This was chosen as there was a real need to appreciate the full effects of automation [how much is enough?]. Concerns were proffered on justification, provision of defensible business case evidence, optimisation, payback periods etc. This seems to mirror the concerns raised in the Manufacturing/Process category. 100% chose Category A when it came to software, as there are so many things unfolding in this area. In particular, incompatibilities in software (Design for Manufacture, Decision Support Systems, Integrated Product Delivery, Material Requirement Planning, Enterprise Resource Planning etc.). Of particular concern was the appropriateness of these to support operations throughout the design-manufacture-assembly cycle. This resonates with 91% of respondents choosing Category A highlighting the importance of training – especially the need for software analysis tools such as systems analysis, discreet event simulation/modelling etc.

Construction/People

82% of respondents chose Category A, citing the need to up-skill all personnel for OSM. 82% also selected Category A on the basis of creating new healthy/comfortable working conditions, improved Health and Safety, and enriched demographics on age/gender barriers etc. 45% selected Category B on sustainability issues, especially on social, environmental, carbon emissions etc.

Construction/Process

64% of respondents selected Category A, noting the need to integrate construction with process and mechanisms for achieving this, especially as BIM/MRP/ERP processes are still unfolding. 73% selected Category A as there was a need to understand the interface between Off Site Production and manufacturing (and the provision of skills to support this). Respondents had mixed views [27.3% Category A; 36.4% Category B; 36.4% Category C] on the need to provide flexibility to support standardisation, economies of scale etc.

Construction/Technology

82% of respondents chose Category B, highlighting the need to understand how information is created, used and exchanged (Product Modelling Ontology, etc.). 55% selected Category B citing the need to understand how technology can support existing products and processes (including new application areas). 73% chose Category A when considering the relationship of risk applied to technological solutions. This seemed to be an underrepresented area which needed greater clarity.

OSM ranked priority areas

Respondents were independently asked to rank ten OSM areas in order of priority, where 1 = most important, and 10 = least important. The results from this exercise are prioritised and ranked (Table 3).

Table 3 OSM Priority Ranking

Category Ranking (where 1 = high)	Respondents											Total	RANK
	1	2	3	4	5	6	7	8	9	10	11		
A. Process Improvement	1	3	1	9	2	4	1	4	4	4	1	34	1
B. Innovation (competitive advantage)	5	1	10	6	1	6	4	6	5	6	2	52	5
C. Technology (BIM, new tools, big data etc.)	2	2	2	5	9	5	3	5	6	5	5	49	4
D. Visualisation and Integration (through current/emerging digital technologies)	3	7	3	10	10	10	5	9	10	10	7	84	8
E. Production and Process Models	8	5	5	8	3	3	8	2	3	3	4	52	5
F. Strategic and Operational Business Models	9	4	6	7	4	2	6	1	1	2	3	45	3
G. Training and Development	4	6	4	1	5	1	7	3	2	1	6	40	2
H. Sustainability (as key a USP)	10	10	7	2	6	8	9	8	8	8	10	86	9
I. Value (through life – customisation, change in use etc.)	6	9	8	3	8	7	2	7	7	7	9	73	7
J. Materials (skins, retrofitting, smart components etc.)	7	8	9	4	7	9	10	10	9	9	8	90	10

4.2 Discussion

The results from the Focus Group sessions aimed to garner significant insight into current thinking, especially the direction of travel for OSM compared with the findings proffered in the TG74 report elucidated earlier. Of note, whilst many of these findings still resonate with respondents identified in this study, there are a few salient points to highlight. For example, the need to embed people into the decision making process, especially considering the skill sets needed to support the design process. This supports the premise that business value is a direct derivative of the value chains placed on delivering the end product; which, reflected observations on the need to have both product and process supported by such technologies as BIM. That being said, it is equally important to embrace training (and upskilling) throughout the whole process, especially as different processes and thinking (design, construction, manufacturing, assembly) as the provision of an appropriate organisational skill base more often than not directly impinges on outcomes. In some respects, perhaps learning from other industries would be a distinct advantage for the OSM community. On this theme, from this research there was a need to provide actual evidence chains to support claims. New business models and innovation opportunities are predominantly reliant on proven data (to support anticipated outcomes). This is something that needs additional work. Finally, findings from Table 4.1 emphasise the need to look at core processes [Rank 1] as the main priority. This aligns to many previous schools of thought in this area (e.g. Blismas *et al*, 2006), including Business Process Reengineering (BPR), Process Protocol (PP), etc. Other factors of importance included training [Rank 2], to support the changes needed to effectuate OSM success throughout the whole delivery stream cycle, and not through discipline-specific siloes (Nadim and Goulding, 2009). Allied to this was the need to create clear (distinctive) business models [Rank 3] for OSM, which resonates with the need to create strategic opportunities in offsite (Brege *et al*, 2014; Goulding *et al*, 2014). The provision of these will not only help to create more defensible business decisions, but will also act as vehicles for product differentiation, to leverage innovation and other commercial opportunities. Given this, it is proffered that the OSM community needs to think about this very carefully, as this can affect OSM’s future direction (and opportunities). On this issue, it is advocated that a conjoined alliance of expertise (advisors, researchers clients, developers, designers, contractors, manufacturers, suppliers, and governmental bodies) are needed to make this happen.

5. CONCLUSION

This paper presented a series of OSM challenges, issues and opportunities. It highlighted a distinct knowledge gap regarding the need to capture core priorities. From this, a Focus Group using 11 domain experts from nine countries was used to unpick some of the most important factors affecting OSM. Three main findings highlighted the need to i) investigate core processes ii) develop the appropriate skill sets needed to support OSM, and iii) create clear [new] OSM business models supported by evidence chains. One of the challenges here is the myriad of roles and entrenched thinking often associated with siloed positioning. On this issue, it was proffered that there was a need (albeit Utopian) to create conjoined thinking on such matters. Given that this study in itself could be perceived as being myopic (due to its limited sample size), there are much wider implications to consider here – perhaps something to explore in later works? Finally, from a generalisability and repeatability perspective, it must be noted that the findings presented in this paper are purely from this same sample frame only. Whilst no attempt has been made to undertake detailed cross-analysis from these data sets, the findings themselves are therefore deemed uncorrelated. Further work is needed in this area, including cross-case comparisons to support internal/external consistency, validity and homogeneity.

6. REFERENCES

- Akintoye, A., Goulding J.S, and Zawdie, G., (2012), *Construction Innovation and Process Improvement*, Wiley-Blackwell, UK
- Arashpour, M., Wakefield, R., Lee, E.W.M., Chan, R., and Hosseini, M.R., Analysis of interacting uncertainties in on-site and off-site activities: Implications for hybrid construction, *International Journal of Project Management*, 34, pp. 1393-1402, <http://dx.doi.org/10.1016/j.ijproman.2016.02.004>
- Arif, M., and Egbu, C., (2010), *Making a case for offsite construction in China*, *Engineering, Construction and Architectural Management*, Vol. 17(6) pp. 536-548
- Barlow, J., Childerhouse, P., Gann, D. M., Hong-Minh, S., Naim, M., and Ozaki, R. (2003), *Choice and delivery in housebuilding: lessons from Japan for UK housebuilders*, *Building Research & Information*, 31(2), pp. 134-145. <http://dx.doi.org/10.1080/09613210302003>
- Blismas, N., (2007), *Off-site manufacture in Australia: Current state and future directions*, Cooperative Research Centre for Construction Innovation, QUT, Brisbane, Australia
- Blismas, N.G, Pendlebury, M., Gibb, A., and Pasquire, C., (2005), *Constraints to the Use of Off-site Production on Construction Projects*, *Architectural Engineering and Design Management*, Vol. 1, Iss. 3, pp. 153-162
- Blismas, N.G, Pasquire, C., and Gibb, A., (2006), *Benefit evaluation for off-site production in construction*, *Construction Management and Economics*, Vol. 24(2), pp. 121-130 <http://dx.doi.org/10.1080/01446190500184444>
- Brege, S., Stehn, L., and Nord, T., (2014), *Business models in industrialized building of multi-storey houses*, *Construction Management and Economics*, Vol. 32(1-2), pp. 208-226 <http://dx.doi.org/10.1080/01446193.2013.840734>
- CIC (2013), Construction Industry Council, *Offsite Housing Review February 2013*, Ed. Miles, J., and Whitehouse, N., CIC, London, UK
- CIDB (2015), Construction Industry Development Board Annual Report 2015, <http://www.cidb.gov.my/cidbv5/images/content/2017/korporat/CIDB%20Annual%20Report%202015.pdf> (accessed May 2017)
- de Vries, B., Verhagen, S. and Jessurun, A. J., (2004), *Building Management Simulation Centre*, *Automation in Construction*, 13(5): pp. 679-687
- Egan, J., (1998), *Rethinking Construction: The Report of the Construction Task Force to the Deputy Prime Minister*, DTI, London, UK
- Gibb, A.G.F., (1999), *Off-Site Fabrication: Prefabrication, Pre-Assembly and Modularisation*, Whittles Publishing, Caithness, Scotland, UK, ISBN-13: 978-0470378366
- Goulding, J., Nadim, W., Petridis, P., Alshawi, M., (2012), *Construction Industry Offsite Production: A Virtual Reality Interactive Training Environment Prototype*, *Advanced Engineering Informatics*, Vol. 26, Issue 1, pp. 103-116

- Goulding, J.S., and Arif, M., (2013), *Research Road Map Report: Offsite Production and Manufacturing*, Publication 372, International Council for Research and Innovation in Building and Construction, ISBN 978-90-6363-076-8
- Goulding, J.S., F. Pour Rahimian, M. Arif, and M.D. Sharp, *New offsite production and business models in construction: priorities for the future research agenda*, Architectural Engineering and Design Management, 2014, 11(3) pp. 163-184. <http://dx.doi.org/10.1080/17452007.2014.891501>
- Gu, N., and London, K. (2010), *Understanding and facilitating BIM adoption in the AEC industry*, Automation in Construction, 19(8), pp. 988-999
- HAC (2011), *Preserving Affordable Manufactured Home Communities in Rural America: A Case Study*, Housing Assistance Council, Washington, USA
- Hampson, K.D., and Brandon, P., (2004), *Construction 2020 - A vision for Australia's Property and Construction Industry*, CRC Construction Innovation, Brisbane, Australia
- Isikdag, U., Underwood, J. and Kuruoglu, M., (2012), *Building Information Modelling*, in Akintoye, A., Goulding, J.S., and Zawdie, G., (Eds.), Construction Innovation and Process Improvement, Wiley-Blackwell, UK
- KPMG (2106), Smart construction: How offsite manufacturing can transform our industry, CRT059791, April 2016, <https://assets.kpmg.com/content/dam/kpmg/pdf/2016/04/SmartConstructionReport.pdf> (accessed May 2017)
- McGuinness, S., and Bennett, J., (2006), Examining the link between skill shortages, training composition and productivity levels in the construction industry: evidence from Northern Ireland, The International Journal of Human Resource Management, 17(2), pp. 265-279 <http://dx.doi.org/10.1080/09585190500405538>
- Nadim, W., and Goulding, J.S., (2011), *Offsite Production: A Model for Building Down Barriers: A European Construction Industry Perspective*, Journal of Engineering, Construction and Architectural Management, Vol. 18, (1) pp. 82-101
- Nadim, W., and Goulding, J.S., (2009), *Offsite Production in the UK: The Construction Industry and Academia*, Architectural Engineering and Design Management, Vol. 5 (3) pp. 136-152
- Nahmens, I. and Ikuma, L.H., (2012), *Effects of Lean Construction on Sustainability of Modular Homebuilding*, Journal of Architectural Engineering, Vol. 18, No. 2, pp.155-163
- Nawari, N., (2012), *BIM Standard in Off-Site Construction*, Journal of Architectural Engineering, 18(2), pp. 107-113 DOI: [http://dx.doi.org/10.1061/\(ASCE\)AE.1943-5568.0000056](http://dx.doi.org/10.1061/(ASCE)AE.1943-5568.0000056)
- NHBC (2006), *A guide to modern methods of construction*, NHBC Foundation, Amersham, UK
- Pan, W., Gibb, A.G.F., and Dainty, A.R.J., (2007), *Perspectives of UK housebuilders on the use of offsite modern methods of construction*, Construction Management and Economics, 25:2, pp. 183-194, <http://dx.doi.org/10.1080/01446190600827058>
- Pan, W., Gibb, A.G.F., and Dainty, A.R.J., (2012), *Strategies for Integrating the Use of Off-Site Production Technologies in House Building*, Journal of Construction Engineering and Management, 138(11), pp. 1331-1340
- Soetanto, R (2010), *ACT-UK simulation centre: opportunities and challenges for research*, In: Egbu, C., (Ed) Procs 26th Annual ARCOM Conference, 6-8 September 2010, Leeds, UK, Association of Researchers in Construction Management, pp. 143-152.
- Tah, J. H. M. (2012), *Virtual Planning and Knowledge-based Decision Support*, in Akintoye, A., Goulding, J.S., and Zawdie, G., (Eds.), Construction Innovation and Process Improvement, Wiley-Blackwell, UK
- Taylor, M.D., *A definition and valuation of the UK offsite construction sector*, Construction Management and Economics, 28:8, pp. 885-896, DOI: 10.1080/01446193.2010.480976
- Thuesen, C., and Hvam, L., (2011), *Efficient on-site construction: learning points from a German platform for housing*, Construction Innovation: Information, Process, Management, Vol. 11 Iss: 3, pp. 338 – 355
- Winch, G., (2003), *Models of manufacturing and the construction process: the genesis of re-engineering construction*, Building Research & Information, Vol. 31, Iss. 2, pp. 107-118

EXPLORING OPPORTUNITIES OF INTEGRATED PROJECT DELIVERY IN OFF-SITE MANUFACTURING OF THE AUSTRALIAN HOUSING SECTOR

O. Ibidapo¹, K. London¹, A. Elmualim¹, Z. Pablo¹ and P. Bayetto²

¹University of South Australia, Adelaide, Australia

²FMG Engineering Adelaide, Australia

Email: Olutope.ibidapo@mymail.unisa.edu.au

Abstract: The Australian housing sector is underperforming; supply doesn't meet demand, quality is questionable and there are significant delays in delivery time. Off-site manufacturing has been promoted as a solution. Off-site manufacturing involves the production of building components in a controlled facility which are transported to construction site for installation and assembling. Past studies have revealed several benefits of off-site manufacturing and despite the numerous compelling arguments associated with adoption, its application is yet to be fully realised. Potentially a key barrier inhibiting the uptake of off-site manufacturing is the lack of the early involvement of key project participants at the outset of a project. This barrier may arise due to the project delivery methods the sector participants' pursue. This study seeks to explore integrated project delivery as a solution. An integrated project delivery method integrates people, business practices, culture and structures into a process. The novel delivery method is beneficial because it enables early involvement of project participants. Integrated Project Delivery also leverages the combined knowledge structurally through the use of multiple-party agreements. A review of literature suggests that there are various factors that influence the uptake of this delivery method including; user experience, contractual, insurance, cultural, financial and legal. The implication of adoption of this novel delivery method and its application to the housing sector is initiated.

Keywords: Challenges, Delivery Modes, Housing, Integrated Project Delivery

1. INTRODUCTION

The Australian housing sector, similar to other countries, has acknowledged the importance of off-site manufacturing (OSM) and the numerous advantages linked to its application. OSM has been established as beneficial to all stakeholders in the construction process and it has also been regarded as a vehicle that has the potential to drive much needed improvement, productivity and innovation within the industry (Jaillon and Poon, 2009, Duc et al., 2014). One of the major benefits of OSM is the reduction in time expended in the construction of building projects (Kamali and Hewage, 2016). OSM enables both the factory manufacturing of building components and site preparation activities to occur concurrently. In addition, OSM can minimise risk of delays due to extreme weather (Lu and Liska, 2008), site theft and destruction (Cartwright, 2011).

Nevertheless, despite the numerous acknowledged compelling drivers associated with OSM, its application is yet to be fully maximised within the industry. The present state of the adoption of OSM by the Australian housing sector is promising but still remains an area of significant opportunity (Steinhardt et al., 2014). The current limited success level of OSM uptake and acceptance within the industry contradicts the wide promotion (Duc et al., 2014), hence its anticipated impact is still far from being accomplished.

The reasons for the failures of the industry to achieve a large-scale transition to off-site manufacturing have been reasonably well documented. These barriers include among others: poor design (Dalton, 2013), inability to freeze specification and design early into the OSM (Blismas et al., 2012), shortage of design expertise needed for large scale production (Blismas and Wakefield, 2009), and failure of the industry to change from conventional methods of construction design and practices (Dalton, 2013).

However, the key underlying barrier inhibiting the uptake of OSM in the Australian housing industry, could be attributed to a lack of integration and collaboration at all levels among the industry practitioners and organisations involved in OSM projects, due to the deeply rooted industry structure and fragmented nature of the industry (Pan et al., 2007, London et al., 2015). This situation hinders the early contribution of knowledge and flow of information required for OSM projects, thereby posing barriers to solutions to problems that could have been realised at the initial stage but are only later discovered during production and construction.

Early involvement of key participants can enable innovative technologies to be explored as alternative approaches to traditional construction methodologies. It is suspected that the lack of the early involvement of project participants is due to the project delivery methods the industry has been using. This study seeks to explore integrated project delivery as a solution. Integrated Project Delivery (IPD) is a new evolving delivery method in the broader construction industry that offer opportunities for the early integration of various project participants to be involved at the outset of project but is entirely new to housing actors.

The paper is arranged in three major sections. The first section discuss the various common project delivery approaches deployed for the delivery of the traditional construction (on-site) projects which is still being transferred to the delivery of the off-site manufacturing projects with their respective advantages and disadvantages. The subsequent section introduces IPD and highlights the key principles. Finally an analysis of the challenges associated with IPD implementation within the Australian housing industry is presented.

2. COMMON PROJECT DELIVERY METHODS

The success of a project when measured against the construction metrics of time, quality and cost, may depend to a large extent, on the types of project delivery methods adopted (Mollaoglu-Korkmaz et al., 2013). There are many project delivery methods in the construction industry that owners could choose from for the execution of their projects. This section briefly discusses some of the common methods of project delivery used for construction work.

2.1 Design-bid-build

The conventional project delivery method, generally known as design-bid-build (DBB) in the US is the oldest and the most common method for project delivery in the construction industry (Walker, 2015). Under this model, the owner enters into two separate contractual agreements with the designers and the contractors (Moynihan and Harsh, 2016).

DBB is well known, established and understood by most firms and professionals involved in the construction process. However, due to the sequential procedural flow of this approach and attendant contractual arrangements, it typically eliminates the opportunity to incorporate the

contractor's expertise knowledge during the design developmental process, as they are usually brought in after the completion of the design and indeed after the tender has been completed. According to AIA (2007) the non-involvement of contractors during the design phase, conceals considerable issues which later emerge and are discovered during construction, thereby resulting in increased errors and disputes, higher costs and elongated project durations.

2.2 Design-build

In the design-build (DB) method a design-builder is engaged to carry out both the design and the construction of the project according to the design brief produced by the owner. The assigned design-builder signs a single contract with the owner for the performance of the design and construction services (Mollaoglu-Korkmaz et al., 2013).

While design-build has numerous advantages connected with time, quality, performance and cost (Moynihan and Harsh, 2016), there are still some challenges associated with its use. For instance, due to the single point of contact, design-build lacks accountability connected with design-bid-build contracts. Under the traditional design-bid-build system, the designer is loyal to the project owner and ensures the work executed by the contractor creates the anticipated value to the owner. But in design-build, both the designer and contractor work together and may be in conflict with the owner. This contradicts the checks and balances that the traditional method provides (Azhar et al., 2014).

2.3 Construction Manager at Risk (CMAR)

Construction Manager at Risk is another delivery approach to the planning, design and construction of projects, in which the owners engage the expertise and services of two separate firms, that is an agent construction manager (CM) and the architect/design team. The owner signs two separate contracts, one with the construction manager and the other one with the design team/architect. CMAR brings the owner, construction manager and the design team/architect early together, integrating them into a team by utilising the unified knowledge and experience of all the parties (Shane and Gransberg, 2010).

CMAR offers some appealing advantages to owners. Because of the pre-construction services rendered by the construction manager, the soon-to-be contractor's experience and expertise can be made use of early during the design stage (Anderson and Damnjanovic, 2008). However, CMAR has some disadvantages that may limit its use and create problems to the owner. One such challenge relates to the opposing agendas of the designer and the construction manager at design stage. An owner hires a construction manager for cost effectiveness in the course of the design (Ramanathan et al., 2012). The construction manager ensures the project does not surpass budget. Nevertheless, the design team's obligation is to ensure that the project complies with all applicable laws, codes and regulation, while offering the required technical know-how (Shane and Gransberg, 2010). If this situation is not well managed, it can produce an adversarial relationship between these two parties that could disrupt the project.

It can be seen from this discussion on project delivery methods that the majority of the challenges obstructing the large-scale adoption of off-site manufacturing, particularly in the Australian housing industry, can be credited to the procurement route the industry is following for the delivery of projects. This is due to the fact that these methods do not allow for

meaningful collaboration and integration of all the professional team during design and throughout the entire process of the project execution. It can be said that none of these delivery methods work best in all project aspects and perform superlative on all fronts. The reason is that these methods were established with restricted concentration on attaining discrete goals rather than the whole delivery system development and hence their approaches are fragmented. Azari-Najafabadi et al. (2011) considered this localised concentrated method as a cause why owners and the industry at large fails to realise anticipated objectives.

Construction industry scholars and industry practitioners are advocating for the implementation of other integrated methodologies to overcome this fragmentation concern and to attain more predictable project outcomes. Essentially, such a method should give opportunities for every member of the project team to relate, communicate efficiently and participate well through all the project stages (Kent and Becerik-Gerber, 2010). Integrated project delivery that is discussed next is one of the emerging project delivery methodologies with potentials to address this fragmentation.

3. INTEGRATED PROJECT DELIVERY (IPD)

Integrated project delivery (IPD) is defined by the American Institute of Architect (AIA) as:

a project delivery approach that integrates people, systems, business structures, and practices into a process that collaboratively harnesses the talents and insights of all project participants to optimize project results, increase value to the owner, reduce waste, and maximize efficiency through all phases of design, fabrication, and construction (AIA, 2007:1).

IPD is an example of a modern method of construction project delivery with potential to meet demands for innovative and effective processes for better, faster and less adversarial construction projects (Lim et al., 2016). IPD depends on teamwork, integration, mutual trust and respect among all the organisation and parties involved in the project. IPD utilises project integration method to assemble together the various organisations involved in a project to form an effective team that concentrates on project goals (AIA, 2007). In some situations, IPD can be a radical culture change from other common delivery methods, in which most organisations are merely concerned about themselves and are less concerned about the well-being of other participating organisations or the project. In contrast to other delivery methods, the interactions between people from different organisations become critical.

Several authors have examined the difference between IPD and traditional project delivery methods in their studies. For instance, El Asmar et al. (2013) compared the performance of IPD and non-IPD projects through a comprehensive quantitative study. Findings from the study revealed that IPD projects proved to have a superior performance in metrics related to quality, communication and change performance than non-IPD projects. In addition, IPD projects undergo less changes, achieve faster processing times and considerably faster delivery times. The researchers concluded that IPD deliver projects more quickly and with higher quality and with no significant cost premium.

Nanda et al. (2016) found similar results in their investigations. The respondents were asked to evaluate if IPD processes are better than non-IPD processes based on their experiences with both processes; in terms of scheduling, overall cost, overall quality, safety during construction,

learning of the stakeholders and morale of the stakeholders. According to the researchers, on average, all the stakeholders affirmed that the IPD process is better than non-IPD process in terms of all the metrics. They also identified the major advantages of IPD as collaboration, team engagement, pursuit of common goals, relationship building, end user buy-in and engagement.

Matthews and Howell (2005:61) evaluated the result of the use of IPD on four case studies. In conclusion they noted impacts of IPD on four aspects of the team integration: design creativity process, cooperation, innovation and collaboration. Concerning design, they found that integration among team members generated creative ideas that otherwise would have been impossible to discover in a traditional setting. Regarding cooperation, innovation and collaboration, they discovered a major behavioural change, (for example appointment of a leader chosen by the team to direct the activities of the team in the most efficient way) and immediate problem resolution on IPD projects.

In summary the studies provide some evidences for integrated project delivery being superior to non-integrated project delivery. A multitude of metrics were used by researchers in their studies to indicate the potential superiority of IPD over non-IPD.

The unique cornerstone principles of this sophisticated delivery method have been discussed previously however, for the purpose of this paper, some of these principles as identified by AIA (2007) which include: Early involvement of key participants (EIKP), Multi-party agreement (MPA), risk sharing and rewards and liability waivers among participants are briefly considered.

3.1 Early involvement of key participants (EIKP)

The early involvement of key participants from the outset and initial conceptualisation stage of projects is a distinguishing technique used on IPD projects. Nevertheless, this technique exists also in other types of commonly used methods of project delivery within the construction industry. On projects where the Construction Manager at Risk delivery method is utilised, a general contractor is usually brought in early at the design stage to supply useful input and assistance. Design-build likewise includes a contractor during design as part of the design builder firm. However, IPD takes this a step further and in many cases by involving early, the owner, architects, contractor, suppliers, fabricators, subcontractors such as mechanical, structural, civil, electrical, and plumbing, and all other key parties during the development and design stage of the project to enhance team collaboration and minimise future constructability issues by addressing them early during the design stage and not later during the construction execution stage (Post, 2011). According to AIA (2007) pooled knowledge and expertise of all major participants is most effective during the project's early life where informed decisions have the greatest impact. The opportunities of influencing project success are seen also to be best during the early project phase, because when appropriate and right decisions are collectively made, reduction in total life-cycle cost of a project is realised (Aapaoja et al., 2013).

3.2 Multi-party agreement (MPA)

A multi-party agreement is defined by the American Institute of Architectures (AIA) as a form of agreement where the “primary project participants such as owners, architects, engineers, contractors, construction managers, major consultants and subcontractors, and other organizations vital to the success of the project, execute a single contract specifying their respective roles, rights, obligations, and liabilities” (2007, p.32).

MPA are different from the traditional project delivery methods where the project owner normally has a separate contract with the architect and the general contractor. When MPA is used, participants understand their roles in relation to other team members more deeply. Kent and Becerik-Gerber (2010) argues that MPAs enhance maximum collaboration among team members to collectively focus on the project goal. Since project success is dependent on members working as a collaborative team, trust and commitment to working as a team in achieving the project goals are requirements for a MPA to be successful (Fish, 2011).

3.3 Risk sharing and rewards

In an Integrated Project Delivery (IPD) project, the key participants share risk and reward, a distinguishing feature that is being used to incentivize team collaboration as the compensation method. Unlike traditional projects delivery method where each participant focuses on how to individually preserve their financial success by minimising risks that relates to their own section of work, without being mindful of the consequence of risk on the overall project outcome, IPD contractual agreements ties the financial compensations and the risks sharing and rewards system of all participants to the overall achievement of the project objectives and outcome, not just a single part or element (Kent and Becerik-Gerber, 2010).

Linking financial compensation, risk and reward sharing method to overall project success discourages selfish actions from the IPD project teams. Applying risk and sharing methods increases project commitments and serves to align the parties to centrally focus on the project objectives. Aligning the focus of the teams to the overall project success enables parties to provide suggestion or assistance to other parties because of their perception that they are now ‘rowing in the same boat’. Project teams appears to gain more collective control of the overall process and better mitigate the overall risk (Cohen, 2010).

3.4 Liability waivers among participants

The waiver of claim is another principle that is exclusive to fully integrated projects. Applying a waiver claims prevents parties from initiating lawsuits against each other. In an integrated project delivery contracts, there are certain clauses that provide exemption of claims to key participants against each other, except for issues arising from fraud, negligence or wilful misconduct (AIA, 2010). Eliminating the potential to sue emphasises a focus on project objectives and not individual or participating organisations involved in the project. Thus, collaboration occurs more prominently when people focus on the project goals and working through problems internally. Zhang and Chen (2010) reiterate that using the liability waiver clause, risks are allocated more evenly, and more confidence is built amongst the team members and the IPD process.

Nevertheless, despite the transformational change that IPD could bring into the mode of project delivery within the construction industry and particularly the potential application of such a robust system in the off-site manufacturing of the Australian housing industry, its implementation may not be easy. There are some factors that may discourage the practitioners within the Australian housing industry from accepting such an alternative project delivery method. The following section will briefly analyse some of these challenges.

4. INTEGRATED PROJECT DELIVERY CHALLENGES FOR HOUSING SECTORS PARTICIPANTS

Transformational change is often associated with intensive efforts. Like any new innovative process, the introduction of an IPD would bring with it numerous challenges. Some of these challenges that could pose as hindrance to the implementation of IPD includes; lack of experience of with the delivery method, IPD contractual, insurance, financial, culture and legal (Cohen, 2010, Fish, 2011, Ghassemi and Becerik-Gerber, 2011, Fish and Keen, 2012, Lee, 2013, Rached et al., 2014). These challenges are briefly discussed next.

4.1 Lack of experience of IPD user

The inexperience of the parties involved with the use of IPD, is a critical factor that influences the success of the implementation of this novel delivery method (AIA, 2007, Fish, 2011). IPD needs extensive collaboration skill to integrate expertise, technologies and software (AIA, 2007). If the parties involved are lacking knowledge on how to navigate this approach, it will more than likely create disharmony, friction within the parties and not deliver the anticipated results that an IPD method can provide. Typically it is the owner who often determines the right parties to be assembled for an IPD project. If the owner is unexposed and uninformed regarding how IPD works, they will not know how to assemble the appropriate team for the project. It is imperative that the owners are conversant with the IPD method to assemble a team that will be on the same page, united, share common values and goals. According to Hellmund et al. (2010), this challenges can be resolved through learning, training and prioritising the implementation of IPD education across the industry.

4.2 Contract challenges

The existing conventional contract for the traditional construction is not suitable where an IPD is employed as a delivery method. The rationale is that the contractual relationship among the parties involved in the construction project and the method of compensating them for work executed is much different to the IPD method. Contrary to most of the other forms of project delivery methods, where parties enter into the project at different phases and are mainly concerned with their allocated job, IPD contracts take into consideration the reality that all parties participate from the start of the project where everything is done through group efforts. A contractual relationship like this is challenging with the traditional contract because it is not designed for teamwork. However, a contractual relationship through which the parties are jointly tied together with the focus on group project goal achievement by a contract is the bedrock of IPD. Since this approach is a new evolving area in the construction industry where things are done differently, there are often few examples or few experiences to draw from which can be followed for the drafting of the IPD contract (AIA, 2007). Although there have

been more and more examples of IPD since its inception some years ago, but there has been few if any examples in the Australian housing sector. Consequently, establishing an IPD contract for projects can lead to more negotiation, higher legal cost for its drafting because of the time needed for establishing this (AIA, 2007, Fish, 2011). An IPD contract would need to take vision and leadership from the client and would need a significant major development where innovation was a priority.

4.3 Insurance challenge

Insurance is another major challenge linked with the use of IPD (Fish and Keen, 2012). The “no claim” clause ethos that provide for an exemption of claims to key participants against each other, except for issues arising from fraud, negligence or wilful misconduct has been applauded as a means of promoting collaboration among the team member. However, this clause complicates the readiness of the insurance companies in responding to the evolving need of the IPD project to insure all participating parties under one policy (Hudson, 2014). This implies that the IPD members as a group may have no underwritten insurance policy in place that could cover them in the event of third party claim. Obtaining insurance when relinquishing liability is very complicated, more costly than traditional insurance, hard to find and legal procedure is limited (Post, 2011). Although in the US, IPD has been implemented for some years now and some of these issues have now been resolved the initiation of such approach in Australia would yield similar challenges.

4.4 Cultural challenges

Cultural challenges to IPD implies the reluctance of the construction industry to change from its conventional approach (Ghassemi and Becerik-Gerber, 2011). This is not surprising, as many construction firms are familiar with their own management methods. The underlying issue is changing the inertia and changing the mindset of the practitioners that is built on the traditional method (Lichtig, 2006, Rached et al., 2014).

For instance, under the traditional project delivery approach, it is the architect who normally acts as the project ‘facilitator ‘and the “middle man” between the owner, design team and the construction for interaction, the setting up of meeting among the parties and tracking paperwork on project they are working on. In an IPD project, it is completely different as these responsibilities are taken up by every team member. It is difficult to believe that in the course of the early implementation of an IPD that the team would be that integrated and organised with no need within them of having “special skilled person” acting as the project facilitator and or a leader. This suggests that anybody in the core team has the potential to function as the facilitator and/or the leader (Fish and Keen, 2012), which varies significantly from the usual practice where an architect functions in this capacity. Therefore a major challenge is to have a team comprising of people who are knowledgeable and well trained on all areas of IPD project for its facilitation. This may sound easy theoretically but to have people with such abilities is challenging as it entails professional willingness to change to uncharted areas.

4.5 Financial challenge

The financial challenges refers to the difficulty of choosing an appropriate compensation and incentives packages proportionate to the distinctive characteristics of the IPD projects and for the participants involved in its delivery process (Cohen, 2010). Compensation and incentives are an area of concern particularly for people that are just coming into terms with IPD as a project delivery method (Lee, 2013). An elaborate analysis is needed before prospective parties sign the multiparty agreement that defines risks that will be allocated to each of them during project execution. When an incentive program is not taken into consideration this could appreciably weaken the morale of the project team and consequently affect their productivity.

5. CONCLUSIONS

This paper has discussed integrated project delivery, a methodology that has emerged in the construction industry as a delivery method that can be explored to address the problem of fragmentation that hinders the early involvement of key participants in OSM projects. The various methods of project delivery adopted by the industry with their respective advantages and disadvantages were initially discussed towards developing the argument that an integrated project delivery is perhaps the most appropriate delivery method suitable to helping solve the problem of off-site manufacturing adoption in the housing sector. The integrated project delivery method was discussed in detail. It was observed that the integrated project delivery method creates better opportunities for the early integration and involvement of project participants than other delivery methods. Integrated project delivery enables key project participants to make available timely information during the design stage. Implementation of a structured mechanism that can catalyse early informed decision making in relation to OSM can potentially minimise some of the problems inhibiting a large-scale transition of the Australian housing sector towards the uptake of off-site manufacturing technology.

Conclusively, the challenges associated with the use of integrated project delivery which could discourage the Australian housing sector from accepting it as an alternative project delivery method were briefly analysed. These challenges need to be overcome if the industry is to derive the benefits that this sophisticated method can potentially add to the off-site manufacturing process. The next phase of this study is to develop a deeper understanding of the barriers speculated upon in this paper through an empirical inquiry and develop an adapted or modified version that would encourage adoption of both IPD as a tool to catalyse more widespread adoption of off-site manufacturing in the housing sector.

6. REFERENCES

- Aapaoja, A., Haapasalo, H. & Söderström, P. 2013. Early stakeholder involvement in the project definition phase: case renovation. *ISRN Industrial Engineering*, 2013.
- AIA, C. 2007. Integrated project delivery: A guide. *report by AIA California Council*.
- AIA, C. 2010. Integrated Project Delivery: Case Studies AIA. *California Council in partnership with AIA*.
- Anderson, S. D. & Damjanovic, I. D. 2008. *Selection and evaluation of alternative contracting methods to accelerate project completion*.
- Azari-Najafabadi, R., Ballard, G., Cho, S. & Kim, Y.-W. 2011. A dream of ideal project delivery system. *AEI 2011: Building Integration Solutions*.
- Azhar, N., Kang, Y. & Ahmad, I. U. 2014. Factors Influencing Integrated Project Delivery in Publicly Owned Construction Projects: An Information Modelling Perspective. *Procedia Engineering*, 77, 213-221.

- Blismas, N., Gibb, A. & Pasquire, C. 2012. Assessing Project Suitability for Off-site Production. *Construction Economics and Building*, 5, 9-15.
- Blismas, N. & Wakefield, R. 2009. Drivers, constraints and the future of offsite manufacture in Australia. *Construction Innovation*, 9, 72-83.
- Cartwright, J. T. 2011. Zoning and designing for affordability using modular housing.
- Cohen, J. 2010. Integrated Project Delivery: Case Studies AIA. *California Council in partnership with AIA*.
- Dalton, T. 2013. Australian suburban house building: industry organisation, practices and constraints-final report.
- Duc, E., Forsythe, P. & Orr, K. Is there really a case for Off—Site Manufacturing. The 31st International Symposium on Automation and Robotics in Construction and Mining (ISARC 2014), 2014.
- El Asmar, M., Hanna, A. S. & Loh, W.-Y. 2013. Quantifying performance for the integrated project delivery system as compared to established delivery systems. *Journal of Construction Engineering and Management*, 139, 04013012.
- Fish, A. 2011. Integrated project delivery: the obstacles of implementation.
- Fish, A. & Keen, J. 2012. Integrated project delivery: The obstacles of implementation. Paper presented at the 2012 ASHRAE Winter Conference, Chicago, Illinois.
- Ghassemi, R. & Becerik-Gerber, B. 2011. Transitioning to Integrated Project Delivery: Potential barriers and lessons learned. *Lean construction journal*, 2011, 32-52.
- Hellmund, A., Van Den Wymelenberg, K. & Baker, K. 2010. Facing the challenges of integrated design and project delivery. *IEEE Engineering Management Review*, 38.
- Hudson, K. 2014. [Blog] Integrated Project Delivery: Beneficial or Bad Idea? <http://www.hpwlegal.com/hpw-blog/integrated-project-delivery-beneficial-or-bad-idea>. [Accessed May 10 2017].
- Jaillon, L. & Poon, C. S. 2009. The evolution of prefabricated residential building systems in Hong Kong: A review of the public and the private sector. *Automation in Construction*, 18, 239-248.
- Kamali, M. & Hewage, K. 2016. Life cycle performance of modular buildings: A critical review. *Renewable and Sustainable Energy Reviews*, 62, 1171-1183.
- Kent, D. C. & Becerik-Gerber, B. 2010. Understanding construction industry experience and attitudes toward integrated project delivery. *Journal of construction engineering and management*, 136, 815-825.
- Lee, C. S. 2013. *Implementation of Integrated Project Delivery on Department of Navy Military Construction Projects*. Master thesis, University of Nevada, Las Vegas.
- Lichtig, W. A. 2006. The integrated agreement for lean project delivery. *Constr. Law.*, 26, 25.
- Lim, C., Hong, W., Lee, D. & Kim, S. 2016. Automatic Rebar Estimation Algorithms for Integrated Project Delivery. *Journal Of Asian Architecture And Building Engineering*, 15, 411-418.
- London, K., Pablo, Z. & Khalfan, M. A multilevel analysis of collaboration in offsite manufacturing supply chains using actor network theory. International Conference on Innovative Production and Construction (IPC 2015), 2015. IPC2015 Organizing Committee, 117-122.
- Lu, N. & Liska, R. W. 2008. Designers' and general contractors' perceptions of offsite construction techniques in the United State construction industry. *International Journal of Construction Education and Research*, 4, 177-188.
- Matthews, O. & Howell, G. A. 2005:61. Integrated project delivery an example of relational contracting. *Lean Construction Journal*, 2, 46-61.
- Mollaoglu-Korkmaz, S., Swarup, L. & Riley, D. 2013. Delivering Sustainable, High-Performance Buildings: Influence of Project Delivery Methods on Integration and Project Outcomes. *Journal Of Management In Engineering*, 29, 71-78.
- Moynihan, G. P. & Harsh, C. 2016. Evolution and current state of construction project delivery methods: a two-stage investigation. *International Journal of Construction Project Management*, 8, 57.
- Nanda, U., Rybkowski, Z., Pati, S. & Nejati, A. 2016. A Value Analysis of Lean Processes in Target Value Design and Integrated Project Delivery: Stakeholder Perception. *HERD*.
- Pan, W., Gibb, A. G. & Dainty, A. R. 2007. Perspectives of UK housebuilders on the use of offsite modern methods of construction. *Construction management and Economics*, 25, 183-194.
- Post, N. 2011. Pioneers push paradigm shift. *Engineering News Record (ENR)*.
- Rached, F., Hraoui, Y., Karam, A. & Hamzeh, F. Implementation of IPD in the Middle East and its Challenges. IGLC-22, 22th Conf. of Int. Group for Lean Construction, 2014. 293-304.
- Ramanathan, C., Narayanan, S. & Idrus, A. B. 2012. Construction delays causing risks on time and cost-a critical review. *Construction Economics and Building*, 12, 37-57.
- Shane, J. S. & Gransberg, D. D. A critical analysis of innovations in construction manager-at-risk project delivery. Construction Research Congress 2010: Innovation for Reshaping Construction Practice, 2010. 827-836.
- Steinhardt, D. A., Manley, K. & Miller, W. 2014. *What's driving the uptake of prefabricated housing in Australia?* http://eprints.qut.edu.au/81178/1/QUT-Housing-Project-Industry-Paper-3-web-final_D788.pdf [Online]. [Accessed December 7 2016].
- Walker, A. 2015. *Project management in construction*, John Wiley & Sons.

Zhang, L. & Chen, W. The analysis of liability risk allocation for Integrated Project Delivery. The 2nd International Conference on Information Science and Engineering, 2010. IEEE, 3204-3207.

MAIN CONTRACTOR PERSPECTIVES ON THE DRIVE FOR INCREASED OFFSITE MANUFACTURE

R. Pinney¹, C. Boothman² and A. Higham³

¹ University College of Estate Management, Reading UK

² School of Engineering, University of Central Lancashire, Preston, UK

³ School of the Built Environment, University of Salford, Salford, UK

Email: A.P.Higham@salford.ac.uk

Abstract: Off-site manufacture (OSM) has been promoted in successive government reports as one of numerous potential solutions to the construction industry's inefficiency and low productivity. More recently the Farmer Review has advocated the increased use of OSM techniques could be the key to remedying the endemic skills shortage gripping the sector. Consequently the construction industry has found itself under increasing political pressure to embrace OSM. Yet, despite this rhetoric the industry has been slow to innovate and adopt OSM with traditional site based construction methods continuing to dominate practice. Working with a major UK construction organisation operating in a range of construction markets throughout the UK, the research explores the factors currently informing innovation within the organisation related specifically to OSM adoption to provide a bottom up perspective to this rhetoric routed in current practice. Results from a series of semi-structured interviews with the organisation's senior executives suggest that whilst a series of technical, human and industrial drivers are highly integrated and stimulate OSM adoption. Deeply routed barriers to OSM including: concerns the client would perceive OSM through the lens of post-war housing, the risk adverse nature of contracting given its adversarial nature and historically low margins and finally the financial pressures OSM was perceived to introduce into the firm and its complex supply chain were inhibiting innovation within the organisation.

Keywords: Innovation, Limitations, Main Contractor, Offsite Manufacture, Skills Shortage

1. INTRODUCTION

Over the last two decades successive reports (Egan 1998, Wolstenholme 2009, Farmer, 2016) have called for the increased adoption of off-site manufacture through the construction industry. Following the publication of the Government Construction Strategy (Cabinet Office 2011), which mandates the public sector to achieve significant time and cost efficiencies through innovative industry wide change between 2011 and 2025. Construction research exploring the development of innovation has tended to focus on the triggers and process of innovation within single organisations with a number of models developed focusing on the triggers and processes of innovation. This body of work includes Slaughter's (1998) five-stage magnitude and linkage model that makes the case for incremental innovative change within the firm or wider industry. Barrett *et al's* (2008) generic innovation model that presents a framework for the implementation of innovation based on systems theory and finally Liu and Sexton's (2012) work looking at the importance of knowledge based innovation, that focuses on the firm or industries ability to exploit existing knowledge capital within both individuals and firms. Collectively this body of work provides an important prospective on the adoption of innovation and the decision-making needed to support this process. However, these models do not fully explore how innovation once developed within a single firm or on a single project can then be defused into the wider industry. Nor do they adequately examine the triggers or barriers that prevent other firms adopting the best practice showcased. Although this gap in knowledge has been partially filled via a quantitative study looking at the use of off-site manufacturing in

the House Building Sector (NHBC 2016). Research looking both across the construction industry as a whole and focused research looking at the commercial decision making process within individual organisations and how that determined their use of off-site manufacturing is currently lacking. In an attempt to resolve this problem, this paper presents the initial phase of a larger study looking at the role of adoption and diffusion theory as framework through which a more comprehensive understanding of the factors that are preventing the wider adoption of off-site manufacture can be developed and ultimately resolutions determined.

2. OFFSITE MANUFACTURE

2.1 Off-Site Manufacture

Off Site Manufacture (OSM) is being widely used in the UK particularly for housing as they can represent a saving in both project duration and material usage whilst also producing higher standards of quality (LABC 2013). This combination of benefits, led both Barker (2004) and Callcutt (2007) to call for the increased use of OSM's in the UK housing sector has a potential solution to the delivery of the government's new homes target by 2020. OSM is a universal term used within the construction industry to describe any way of building other those considered traditional, namely standard brick and block cavity construction with or without a steel or concrete frame. However, Kempton & Syms (2009) suggests there is significant difficulty defining OSM's within the current construction management literature. Indeed Kempton identifies that construction professionals commonly use a number of other terms, when referring to OSM's, these include offsite construction, modern methods of construction, modular construction and prefabrication. Vokes & Brennan (2013) further suggests that the terms identified by Kempton & Syms (2009) are often substituted interchangeably with each other through both the academic literature and construction practice. Despite this confusion, the BRE (2009) advances a highly generic definition, asserting that modern methods of construction can be seen as "a range of processes and technologies which involve prefabrication, offsite assembly and various forms of supply chain specifications". Despite the lack of a universal definition for offsite construction, Goodier & Gibb (2007) suggest there are only four widely accepted categories of off-site manufacture (see figure 1) stemming from other manufacturing industries (Vokes & Brennan 2013).

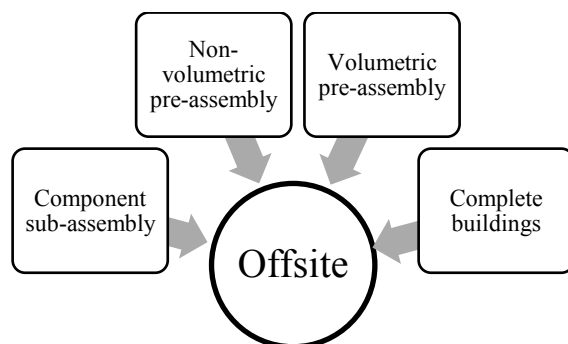

Figure 1: Four categories of off-site manufacture after Vokes and Brennan (2013)

The four main categories highlighted by Goodier & Gibb (2007) are complete buildings, volumetric pre assembly, non-volumetric pre assembly and component sub-assemblies further defined in table 1.

Table 1: The four main categories of off-site manufacture (Vokes and Brennan 2013)

Category	Description
Complete buildings	Units that enclose usable space and actually form part of the completed building or structure (units may or may not incorporate modular coordinated dimensions); typically fully factory finished internally (and possibly also externally), e.g. edge of town hotel or restaurant facilities, multi-residence housing.
Volumetric pre-assembly	Units that enclose usable space that are then installed within or onto a building or structure; typically fully finished internally, e.g. toilet/bathroom pods, plant rooms.
Non-volumetric preassembly	Large category of items that the designer has chosen to assemble in a factory before installation; units do not enclose usable space; applications may be skeletal, planar or complex e.g. panel systems; cladding panels; above ceiling service modules.
Component Sub-Assemblies	Relatively small scale items that are invariably assembled offsite, such as light fittings, doors, windows, door furniture

The use of offsite construction in the UK dates back to Roman times; however, it is most commonly associated with the pre-fabricated post war construction of the 1950s (Vokes & Brennan 2013). Waskett's (2001) influential review charts the early origins of prefabrication in the UK, importantly the review documents the combined pressures of slum clearance, materials shortages and post-war ruin had significantly affected housing supply, faced with increased short-term demand the government bowed to political pressure and adopted pre-fabrication as a stop gap to ease supply- side shortages. A view reinforced by Taylor (2010) who suggests that despite arguments to the contrary, prefabricated housing was no cheaper over its life cycle than traditionally built housing; it simply provided a fast and efficient solution. Indeed once the market reached equilibrium and materials shortages eased constructors reverted to traditional approaches (Waskett 2011). In his evaluation of post-war prefabricated housing for Council of Mortgage Lenders, Ross (2002) opined that in itself the housing was adequate, however, disasters such as Rowen Point and the concerns over quality documented by World in Action, led to a demise of confidence in non-traditional housing, together with the inability to retrofit such properties for modern living they quickly became obsolete.

However, today the use of off-site construction is largely driven by technological advances with modern methods of construction described as the “new products and technologies” that result in “delivery methods, which set out to improve product and process” (CIC 2013). With the BRE (2003) asserting that OSC’s have the potential to introduce greater efficiencies into the construction process, through innovation in building design and management. However, Taylor (2010) opines that the use of factory based systems, typically associated with OSC's are not particularly suitable for one off buildings, suggesting design standardisation would also be needed.

Despite these limitations, the UK construction sector has increasingly adopted off-site manufacture, with 12% of all construction output now taking place in a factory or other off-

site facility (Taylor 2010). However, this figure remains highly subjective as the actual value of offsite construction varies depending on the method and definition used to measure the industry. Gambin (2012) for instance suggests the true estimate to be nearer 7%. Yet, even at Gambin's lower estimate this still equates to an economic contribution in excess of £6bn (Vokes & Brennan 2013). A contribution, which is likely to rise significantly over the forthcoming decade as the construction industry, recovers from recession and the long term implications of a lack of training and skills development start to impact.

2.2 Innovation

It is now widely accepted that the promotion of innovation and innovative thinking is a prerequisite to any competitive advantage. Innovation provides benefit to an individual, an organisation or indeed wider society (West and Farr, 1990). The origins of innovation in the academic literature are traceable back to the influential work of Schumpeter (1934), the core thesis has changed little since the early 20th century. As Schumpeter asserts, innovation can be best described as the outcome of the process through which entrepreneurs eternally seek new production processes through which they can enhance the effectiveness and efficiency of their business. A situation that is notable both in general industry (Slaughter, 2000) and construction specifically (Egbu *et al*, 1998). Embracing innovation thus allows the firm to benefit from continued economic gain whilst protecting existing markets from new entrants who are seeking to replicate their product offering. As such innovation is based on the premise that the organization will generate new ideas that will be implemented within the firm (Thompson, 1965, Slaughter, 1998, Woodcock *et al*, 2000, Sexton and Barrett, 2003). This is especially relevant in construction, where innovation is implemented with the intention of deriving additional benefit, be that from a new design, technology, material component or construction method (Ling, 2003).

Despite the apparent applicability of this firm based view of innovation and its applicability to the construction sector such isolated perspectives of innovation have been challenged within the literature (Feeman, 1987, Lonvall, 1992, Nelson, 1993). At the core of this dispute is the apparent linearity evident in Schumpeter's view of innovation. Together with the apparent isolationist perspective that innovation only takes place in single business units and not through collective actions within the wider industry. Challenging these viewpoints Feeman (1987), Lonvall (1992) and Nelson (1993) espouse innovation to be a non-linear, highly complex process seldom orchestrated by one entrepreneur in isolation but rather something that occurs at a macro level within the industry, a view reinforced through successive government backed reports that have called for industry wide transformation through increased innovation (Latham, 1994, Egan, 1998, Wolstenholme, 2009, Farmer, 2016). Feeman (1987), Lonvall (1992) and Nelson (1993) collectively further challenge the assertion that innovation results solely from supply push or market pull factor within a firm or within the wider industry. Rather innovation, they espouse, is the outcome of a flow of technology and information among people, enterprises, and institutions at various hierarchical levels. Whereby a series of interactions between actor groups transforms ideas into processes, products, or services that are embedded into the industry and offered into the market in a non-linear and therefore far more random way (Van de Ven *et al*, 2008, Zawadie, 2012).

Despite the clear benefits of innovation in terms of business growth and economic efficiency, the construction sector is lagging significantly behind other production based industries when it comes to innovation (Winch, 1998). A situation that continues to be attributed to poor levels

of production efficiency, quality and productivity (Egan, 1998, Koskela and Virjhoef 2001, Wolstenholme, 2009, Farmer, 2016). Whilst some scholars suggest the construction sector is starting to innovate (Slaughter, 1998), this innovation remains at an embryonic stage (Aouad et al, 2010). The vast majority of literature looking at innovation in the sector provides a far less positive outlook. Suggesting the construction sector is structurally incapable of innovation in its current form (Winch, 1998). Amongst the structural barriers to innovation is predominant focus on projects, that gives rise to temporary and short term relationships throughout the supply chain and an inherently site based manufacturing system (Gann and Salter, 2000, Egbu, 2012) prevents large scale innovation as smaller firms, that make up over 99% of the construction industry (Farmer, 2016), cannot achieve the leverage on size, resources or long-term relationships needed to facilitate innovation. This together with high levels of fragmentation (DETR, 2000, Farmer, 2016) and an adversarial culture (Latham, 1994, Egan, 1998, Wolstenholme, 2009, Farmer, 2016) where people and organizations focus on the protection of their ‘turf’ rather than embracing collaborative working has resulted in a further lost opportunity for construction firms too harness the knowledge capital embedded in their workforce that is essential for successful innovation (Egbu, 2012). Finally, the historically tight margins, the need for capital investment and the risk and uncertainty associated with innovation, that means not every innovation the firm implements will lead to improvement are typically identified as fundamental barriers to progress in the construction sector (Sexton and Barrett, 2003, Asad *et al*, 2005, Farmer, 2016) further restrict the levels of innovation achieved within the sector.

Despite acknowledging the many barriers to successful innovation in the construction sector, Farmer (2016), in his recent review of the construction industry for the UK government, repeated earlier calls (Egan, 1998, 2002, Wolstenholme, 2009, Cabinet Office, 2011; 2012) for enhanced innovation in the construction sector by once again reinstating the top-down desire for innovation led modernization of the UK construction sector to improve performance, efficiency and productivity. Whilst Farmer acknowledges that innovation will “continue to be inhibited at all levels by the lack of industry-wide strategic leadership” (Farmer 2016:36). Farmer nevertheless advocated that the industry, its clients and the government should work together to improve relationships, increase levels of investment in R&D and importantly enhance innovation by changing project and production commissioning from traditional on-site systems to pre-manufactured approaches”. Yet whilst the report is silent on how such a transformation should take place, it does reinforce the urgency of determining how the construction industry can be moved into a position where innovation is both accepted and importantly implemented. Accordingly it was resolved in this paper to explore the views of a major construction organisation that has in the past exhibited a propensity to adopt off site manufacture, but to date appears unable to embed this into the day to day processes within the organisation.

3. RESEARCH DESIGN

Working with a major UK construction organisation operating in a range of construction markets throughout the UK the research aimed to investigate the extent to which the use of OSM called for in successive government commissioned reports and reinforced in 2025 construction industry strategy has defused into major contracting organisations. Research is required to explore the extent to which this diffusion has occurred and factors currently informing innovation within the organisation related specifically to OSM adoption. To meet

the objectives, the phenomenological paradigm was adopted, making use of an inductive research strategy supported by a survey methodology based on in-depth interviews.

The research reported in this paper represents the first stage of a broader study, and presents the findings of eight in depth interviews with senior executives from the construction division of a major UK construction development and services group. To achieve a balanced view participants were selected using discriminate sampling, which maximises the opportunity of relevant data collection from a small sample. Participants were invited to take part in a semi-structured interview held at their office and lasting approximately 30-45 minutes.

The interviews sought to establish the key thematic areas from which a broader research agenda can be established. Interviews explored how off-site manufacture diffuses into the company, the triggers for adoption and the significant commercial obstacles that must be overcome at the implementation phase of diffusion if the government's calls for sector transformation are to be achieved. The interviews were recorded with the consent of participants, fully transcribed and loaded into Nvivo qualitative analysis software before being thematically analysed. Open coding was used to identify sub-categories associated with the central themes outlined above. Once a large number of nodes were identified, axial coding revealed relationships between nodes and sub-nodes. As the analysis continued, each category was developed to reflect the content of the data collected and draw out more detailed categories. In developing this process, the data was repeatedly analysed.

4. RESULTS

4.1 Financial fragility

This initial area of enquiry sought to determine the financial fragility barriers associated with the implementation and use of OSM in lieu of traditional construction methods. Areas explored in detail with the participants included design, cost, inflexibility and the financial perceptions associated with use of OSM.

The interviews reveal it is critical clients make early investment decisions if OSM is to be adopted. As a result, the interviewees espoused that they as the constructor had both a duty and commercial obligation to appropriately advise the client, at the initial meeting or as early as possible within the process of the need to expend a large advanced payment if the contractor was to secure the production slot with the manufacture or supplier of the chosen system. As a result, the interviewees stressed that the client would need to both proactive and timely in the decisions they make at the early stages of the project if they are to proceed with OSM and ultimately commission a building that meets their needs and aspirations. However, the challenges this presents cannot be understated, such an approach is very likely going to take the client out of their comfort zone, generally they don't need or indeed contractually desire to make substantial upfront investments or payments when constructing buildings via traditional techniques.

Yet from the prospective of the contractor, there was a consensus amongst the interviewees that delivering a successful OSM scheme would be fundamentally determined by the clients willingness or otherwise to commit to the project, mitigate change at all costs, and most

challenging of all, make a plethora key of decisions, at the initial design stage, that cannot be revisited at a later stage of the project, therefore OSM:

“Requires people to make decisions earlier, nothing wrong with making an early decision it’s just that people aren’t always familiar with doing that” (Interviewee D).

The fact these initial decisions are not required with traditional construction methods, introduces the first major barrier to implementation, as all too often clients are not aware of the importance of early decision making, and may thus feel the contractor is simply being obstreperous:

“Many people want to leave decisions to the last minute and it could feel inflexible to some customers or clients” (Interviewee A).

However from a pre-construction perspective:

“The benefits come from early decision making, however if we take a design up to a certain point with a traditional solution in mind and then change to a prefabricated design issues can arise and it takes a long time to unpick and see the benefit of an offsite solution. (Interviewee B)

Further perceptual challenges are presented when costs are considered, once again a number of the interviewees alluded to off site construction being perceived as more expensive by the client. Although these perceptual inaccuracies often result from a blinkered analysis of the unit rate cost (i.e. cost per square metre) which will often appear to be higher than traditional construction methods, albeit the design fees, overall contract programme and time on site reduce significantly which is demonstrated by savings on preliminaries and associated costs bringing OSM swiftly back into contention on financial grounds. It was suggested by one interviewee that:

“Some cost consultants perceive OSM to be a challenge, as they find it difficult to demonstrate value for money to the customer ” (Interviewee C).

So albeit there is a 70% reduction in the time on site, the main issues concerning the contractor is the clients apparent difficulty comprehending the importance of early investment, engagement and financial commitment needed if the long term value benefits of OSM are to be realised. Regrettably, however, professionals advising employers appear to struggle to develop the appropriate value narrative needed to reassure and convince those commissioning projects that the overall financial case for using OSM is robust and valid. This is especially significant when construction typology decisions are determined on the basis of the overall cost of the scheme without consideration of the wider benefits associated with substantially reduced construction periods alongside the significant reductions in post-occupancy defects and enhanced build quality.

4.2 Perceptual barriers

The next area explored focused on perceptual barriers experienced by clients in relation to the adoption of OSM, albeit from the contractors prospective. These barriers stem, it has been

opined, from previous bad experiences, their overall understanding of OSM buildings performance and the reputation as one director suggested we are:

“An industry still tarnished by some of the work carried out in the 1960’s which in most cases was carried out in a poor fashion, hence absolute disasters like Ronan point, there is probably a big perception barrier that off site is cheap and nasty.” (Interviewee A).

A point that received consensus amongst other interviewees, indeed another director espouses that:

“There is almost a stigma attached to off-site. People still associate it with square boxes and when you stand in front of a customer and say we are going to build using off-site, the alarm bells start ringing for them because they automatically assume that they are going to have a Portakabin for a building. There is almost snobbishness about prefabrication that needs to be broken down”. (Interviewee E).

It was widely suggested that from the interviewees experience of trying to adopt OSM clients have the view that finished product will have a cheap, flat pack appearance like the stuff you can buy from Ikea. For many of the interviewees, this perception is so deeply engrained that clients either cannot or stubbornly will not accept that OSM can be used to produce either a bespoke or iconic building with a high level of finish. Often perceiving that volumetric OSM will mean the design will be restricted to a limited range of pre-determined styles such as in the case of volume pattern book house construction, with all agreeing:

“The biggest barrier is perception of what OSM actually is”. (Interviewee D).

Furthermore clients are not always aware of the progress, developments, possibilities and innovative designs available when considering OSM’s and it is suggested:

“If someone has made up their mind that they don’t want a building constructed using OSM that it” (Interviewee A).

Although these perceptual challenges are not limited to clients and their design teams, the interviews with the organisation’s senior management team revealed initial hostility to the adoption of OSM. Indeed several interviewees described their feelings of trepidation, admitting they were initially very cynical when embracing the change from traditional construction methods to the use of OSM. However all were of the same opinion, schemes they have been involved with had led to a positive experience. Whilst the client benefited from a building that met their expectations, dispelling their initial poor perceptions prior to the commencement of the scheme.

4.3 Productivity and efficiency

Further to perceptual and commercial aspects of the case for OSM, the interviews sought to establish whether, from a contractor’s prospective, production efficiencies and overall productivity benefits had emerged from projects delivered using OSM techniques. Once again the interviews revealed a consensus of opinion from across the organisation that the adoption of OSM had production benefits. Principally, the adoption of OSM shortened construction

periods, as the installation time for the selected OSM was, without exception, dramatically shorter than its traditional counterpart.

“The efficiency and programme saving using off site with the speed in which you can be onsite and watertight. We often have clients with very strict programme dates such as schools needing to hit the September start of the academic year so off site can really help in such cases” (Interviewee D).

Allowing the contractor to concentrate on finishes and other associated aspects of the project. Other secondary benefits included the simplification of procurement, as the huge task of sourcing the numerous components and specialist labour needed for a traditionally constructed building was also removed.

However, the interviewees also suggested these benefits are often not perceived by the client, who will often not witness the main benefits of using OSM. This is particularly the case in respect of productivity and efficiency savings. Although, some interviewees suggested that the benefits could hardly go un-noticed, indeed on one project it was suggested:

“We have saved half of the build duration which equates to less preliminaries and contractor overheads for the customer” (Interviewee D).

Even so, the management team continued to argue that one of the biggest challenges to wider adoption of OSM is time blindness. Even though projects are delivered quicker, with associated savings in preliminary costs and a quicker return on investment as the building is operational quicker. Albeit there is a reduction in the overall time on site, clients don't initially see the reduction in the preliminaries and contractor's overheads unit rates of OSM are still considerably more than those for traditional alternatives. Consequently clients find it hard to see past this challenge, thus it falls on the contractor to continuously emphasise the production benefits and time efficiencies at various stages of the project.

4.4 Quality

The next area reconnoitred through the interviews focused on the quality levels attained with OSM compared to traditional construction methods. All interviewees were of the same opinion that quality is one of the biggest challenges faced by the industry. A problem amplified by decreases in the availability of skilled labour when using traditional construction methods. The greatest benefits of OSM is the improved quality of the overall product, which starts at the design stage; OSM allows the design team time to liaise with the client to:

“Iron out all of the problems at the initial design stage, meaning that we could achieve a finish to the standard that the customer expects and requires, as off-site allows the customer to check the quality, as all the stages of the process are perfectly controlled you know what your getting before it is delivered to site” (Interviewee A).

Furthermore they all agreed that as most of the building is constructed under strict and controlled factory conditions a better quality building was achieved with a higher level of finish, significantly less defects. This demonstrated to significantly less defects been reported both pre and post practical completion, with 85% of the recorded defects not relating to the OSM section of the contract and the other 15% considered as minor issues or damaged caused

by other trades when completing elements of work. This improvement in the quality of the finished, less defects and issues (both pre and post occupation), has resulted in the company seeing a significant rise in the overall customer satisfaction with the project completed using OSM compared to traditional construction methods.

4.5 Combating the labour shortage

The final area explored during the interviews sought to determine the opinions of the contractors on the ability of OSM's to contribute and aid in addressing the labour shortage. There is a consensus of opinion that there is a skills gap within the construction industry, which is causing numerous issues and problems. They all agree and acknowledged that:

“The quality of labour over the past few years has decreased significantly, especially the finishing trades, I think there are a number of pressures on the supply chain that has a knock on effective when they are trying to recruit”. (Interviewee B).

They further acknowledged that the lack of skilled labour in the industry needs to be addressed and a concerted effort is needed to address the apparent skills gap suggesting:

“There are clearly entrenched societal issues associated with a career in the construction industry”. (Interviewee D).

The interviews further revealed that they are all well aware of the need to become more efficient in the way that we deliver schemes, furthermore the schemes that have been completed using OSM have allowed them to maximise on the productivity of their small pool of available skilled labour, however they:

“Question whether there is enough investment, does the industry do enough for people that have been in the industry for 10 or 15 years and whether they have invested in those people to keep them at the cutting edge of technology” (Interviewee C).

All the participants agree that they need to fully embrace OSM as an alternative to traditional construction methods for all future schemes, which in turn will aid in reducing the effects of the labour shortage within the construction industry. However they are of the opinion that this needs to be developed, they need to become more innovative and work in conjunction with the manufacturers. Furthermore they suggest that there is a greater need for individuals at all levels within the construction industry to become more adaptable and for companies to encourage more innovation.

5. CONCLUSIONS

This paper sought to explore how the lack of behavioural change is affecting the implementation of OSM within one major UK based construction company in order to explore how they adopt, promote and diffuse increased levels of off-site manufacture into both their supply chains and the wider industry.

Albeit the individuals interviewed are, on principle not apposed to the implementation of OSM and their experiences have been on the whole positive, a number of commercial complications

or issues have been highlighted that need to be addressed if wider diffusion is to be achieved, and importantly government dictates complied with. The research has revealed that whilst low levels of adoption are not directly related to deficiencies within government policy, the lack of engagement and innovation highlighted by Wolstenholme and re-stated in Farmer's recent review of the sector appear to have resulted from the significant commercial complications plaguing the sector irrespective of how the contract is procured.

Notwithstanding this, it is clear those interviewed could see the significant benefits OSM offers. Yet whilst the firm's senior executives are highly responsive to change, the complications associated with: complex supply chains, low profitability, difficult trading conditions, the lack of advanced payments from the client, even though significant deposits are demanded by OSM manufacturers and finally the perceptual barriers and stigmas relating to the finished scheme culminate to make OSM almost commercially unviable, despite the significant production time and quality benefits trumpeted by successive governments.

6. REFERENCES

- Barker, K (2004) "Barker review of housing supply. Delivering stability: securing our future housing needs". London: HM Treasury and ODPM.
- Barrett, P, Sexton, M & Lee, A (2008) *Innovation in small construction firms*. London: Spon Press.
- Building Research Establishment (2003) "Current Practice and Potential Uses of Prefabrication". Watford: BRE
- Cabinet Office (2011) "Construction 2025 Industry Strategy: government and industry in partnership". London: HM Government.
- Cabinet Office (2016) "Government Construction Strategy: 2016-2020". London: HM Government.
- Callcutt, J (2007) "The Callcutt review of house building delivery" London: DCLG.
- Construction Industry Council (2013) "Offsite Housing Review". London: CIC
- Egan, J (1998) "Rethinking Construction". London: Constructing Excellence.
- Egan, J (2002) "Accelerating Change". London: Constructing Excellence.
- Egbu, C.O.; Henry, J.; Quintas, P.; Schumacher, T. R. and Young, B. A. (1998) "Managing organisational innovations in construction". Proceedings of the Association of Researchers in Construction management (ARCOM) Conference, 9 - 11 September 1998, Reading, UK
- Farmer, M (2016) *The Farmer review of the UK construction labour model*. London: Construction Leadership Council.
- Freeman, C (1985) "The national system of innovation in historical prospective" Cambridge Journal of Economics, 19, 5-24.
- Gambin, L (2012) "Sector Skills Insights: Construction. Evidence Report 50". London: UKCES.
- Goodier, C I and Gibb, A G F (2007) "Future opportunities for offsite in the UK" Loughborough: Loughborough University.
- Kempton, J and Syms, P (2009) Modern Methods of Construction: Implications for Housing Asset Management in the RSL Sector. "Structural Survey". 27(1), 36-45.
- Koskela, LJ and Vrijhoef, R (2001) "Is the current theory of construction a hindrance to innovation?", Building Research and Information, 29 (3) , pp. 197-207
- LABC (2013) "Technical Manual, Version 6". London: LABC.
- Ling, F.Y.Y. (2003) "Managing the Implementation of Construction Innovations", Construction Management and Economics, 21, 635-649.
- Liu, S & Sexton, M (2012) *Innovation in Small Professional Practices in the Built Environment*. Oxford: Wiley-Blackwell
- Lonvall, B (1992) "Innovation System Research and Policy Where it came from and where it might go" [Online] accessible at: [http://www.globelicsacademy.org/2011_pdf/Lundvall_\(post%20scriptum\).pdf](http://www.globelicsacademy.org/2011_pdf/Lundvall_(post%20scriptum).pdf) [18th May 2017]
- Nelson, R R (1993) "National innovation systems: A comparative analysis". Oxford: Oxford University Press.
- NHBC (2016) *Modern methods of construction: view from industry*. Milton Keynes: NHBC
- Ross, K. (2002). Non Traditional Housing in the UK - A Brief Review. Watford: BRE.
- Slaughter, E.S. (1998) Models of construction Innovation, "Journal of Construction Engineering and Management", 124(3), pp.226-231.

- Slaughter, E.S. (2000) Implementation of construction Innovations, "Building Innovation and Research", 28(1), pp.2-17.
- Taylor, M (2010) A definition and valuation of the UK offsite construction sector, "Construction Management and Economics", 28(8), 885-896.
- Thompson, V.A. (1965) "Bureaucracy and innovation", *Administrative Science Quarterly*, 10(1), 1-20.
- Vokes, C. and Brennan, J. (2013). "Technology and Skills in the Construction Industry". Rotherham: UKCES.
- Waskett, P. (2001) DTI Current Practice and Potential Uses of Prefabrication. Watford: BRE.
- Watts, G. (2007). *The Callcut Review of House building Delivery*. London: Construction Industry Council.
- West, M.A., and Farr, J.L. (1990) Innovation at work. In M.A. West and J.L. Farr (Eds), *Innovation and creativity at work: Psychological and organizational strategies* (pp. 3-13). Chichester: Wiley
- Woodcock, D.J., Mosey, S.P. and Wood, T.B.W. (2000) "New product development in British SMEs", *European Journal of Innovation Management*, 3(4), 212-222
- Wolstenholme, A. (2009) *Never waste a good crisis: a review of progress since rethinking construction and thoughts for our future*. London: Constructing Excellence

EXPLORING THE POTENTIAL OF OFFSITE CONSTRUCTION TO ALLEVIATE CONSTRAINTS TO HOUSE BUILDING IN WESTERN AUSTRALIA

M. Sutrisna¹, B. Lofthouse¹ and J. Goulding²

¹ *Construction Management Department, Curtin University, Bentley, Perth, 6845, Australia*

² *Architectural & Built Environment Department, Northumbria University, Newcastle upon Tyne, NE1 8ST, UK*

Email: monty.sutrisna@curtin.edu.au

Abstract: Following the rapid growth of its population, the city of Perth in Western Australia is experiencing an expansion in its housing sector with many of these expansions include more remote areas in Western Australia. It was reported that these endeavours are facing challenges due to the topographical and soil conditions combined with the lack of skilled trades and builders' availability in these remote areas. Given these challenges, this research explores the possibility of utilising offsite construction techniques to address these concerns, especially cognisant that traditional brick and mortar housing is still the most popular choice in Western Australia. This paper presents preliminary findings from a pilot interview which involved five offsite construction industry practitioners in Western Australia. Semi-structured interviews were conducted, followed by content analysis of the transcripts. Preliminary findings revealed that offsite construction could be a viable solution. Moreover, modular is becoming a more attractive construction method for providing real solutions to the challenges facing the house building in Western Australia.

Keywords: House Building, Offsite Construction, Skilled Trades, Soil Condition, Western Australia

1. INTRODUCTION

Perth, the capital city of Western Australia, is currently the one of the fastest growing cities in Australia, with rapid growth mainly being experienced in Perth's outer suburbs (AUDRC, 2015). With a current population of 2.6 million people, it is expected to reach 6.6 million over the next 50 years (ABS, 2014). The areas expecting the largest growth are typically located on the outer suburbs of Perth. This growth will have a direct effect on the number of houses that need to be built over time in these suburbs. The West Australian government has outlined a number of strategies and initiatives for residential housing sector in the future. This includes short-term goals of making an additional 30,000 affordable homes available in Perth (Government of WA, 2010). The strategy also made reference to the need for sustainable construction methods in the future and calls upon a review of the current methods being used and possible alternatives, to see how they can be best implemented.

Traditional construction techniques known as 'brick and mortar builds', are currently regarded the most popular method used in the West Australian residential construction market. Whilst this is the preferred method in Western Australia, the delivery using such a technique has been under pressure due to availability of skilled trades, mainly but not limited to bricklaying, carpentry/joinery, electrical and plumbing trades. The traditional construction method to build a double brick home typically requires adequate footings to transfer the structural load of the building to the foundations. This can be an issue with sites made up of reactive or weak soils, creating the need for additional concrete strength and reinforcing in the design of the footings. This can be a costly exercise, as additional site works will be needed. Whilst the availability of the skilled trades can be considered less under pressure in the Perth metropolitan area, it is not

the case with more remote areas in Western Australia. House building in more remote areas typically struggle to find builders and will attract higher costs. This is exacerbated by the soil conditions in these remote areas in Western Australia that typically consists of more reactive soil. The housing in more remote areas in Australia has generally been considered vital as the indicator of economic sustainability as well as its community liveability and wellbeing (Costello 2009).

Due to these limitations, alternative construction methods are being investigated to sustain housing construction growth in Western Australia. Offsite construction (including modular construction) has been used as a construction technique since the early 1800s but has attracted interest in recent times typically for allowing efficiency and precision, inclusion of environmentally conscious features, better use of declining workforce and shorter construction cycles (Goulding *et al.*, 2014; Smith 2010). Its primary technique that involves moving core activities offsite, i.e. to be completed in a factory environment may potentially provide the solution to the difficulties facing the housing sector Western Australia to cater the house building demands. This research study aims to explore the potential of modular construction as an alternative construction method, and facilitate the expansion of house building in the Greater Perth region. This paper reports the findings from a pilot study undertaken as an initial data collection in this research. Preliminary findings from semi-structured interviews are presented here forming the basis for further research.

2. LITERATURE REVIEW

This section presents the need for residential housing in Western Australia, its population growth, the existing challenges, and the potential for offsite construction to provide viable solutions in more remote areas of Western Australia.

2.1 The need for residential houses in Western Australia

Data from the Australian Bureau of statistics (ABS 2014) indicates that Perth is growing faster than any other capital city in Australia. The resources boom was considered a major driver behind the last 10 years of strong population growth which inevitably put pressure on housing availability (McKenzie and Rowley 2013). Recently becoming the fourth city to reach over 2 million people, Perth has hit the milestone before both Adelaide and Brisbane. Over a 12-month period, Perth's population grew 2.5%, close to an additional 50,000 people (ABS, 2014). Of this growth, the largest increase has been in greater Perth's outer suburbs. For example, Baldivis, on the outer south west of the suburban area has had the most prominent growth, with 3,500 more people in the area. The population has more than doubled in Baldivis over the last 5 years. Additionally new developments in suburbs such as Ellenbrook and Harrisdale/Piara Waters have seen a similar increase with approximately 2,400 more people. The Harrisdale area has seen a significant change as the population has more than tripled over the past five years. Although these areas are experiencing significant growth, some of Perth's inner city suburbs remain the most densely populated. Areas such as Joondanna, Scarborough, Innaloo/Doubleview and North Perth have the highest population densities in Western Australia (AUDRC, 2015).

Based on these statistics and future predictions, ideas have been established regarding Perth's potential expansion and how urbanisation of open areas in Perth could be possible in the future.

For example, the University of Western Australia’s publication “Find the Gap” outlines the potential for infill development, by increasing the population density of the metropolitan area. Infill development refers to the practice of developing under-used or unoccupied areas of land within an existing urban envelope that is principally already developed (MRSC, 2015). Part of the idea of infill development is to increase residential densities high enough to justify improvement in public transportation and additional amenities in the metropolitan. This study also identified 900,000 homes can be built in Perth to potentially accommodate its population growth up to year 2037, when Perth has been projected to host 4 million people (ABS, 2014). Although this is statistically possible, unfortunately, the cost of developments and the effect on the surrounding environment and infrastructure have not been fully considered by the study. After all, the cost of living in the inner suburbs is largely the reason for many younger and lower income earning house owners choosing to purchase or build their homes in the outer suburbs of the greater Perth region.

Statistical analysis identifies that the majority of Perth’s inhabitants prefer to live in a home with more garden space in comparison to apartment’s living. This is supported by the Australian Urban Design Research Centre’s (AUDRC) research indicating that the average person in Perth has 157 square metres of backyard or open space, in comparison to the average in new residential developments in Australia with only 47 square metres. Therefore, the inevitable urban sprawl is predicted to continue over the next 50 years and populate the currently non-urbanised areas of greater Perth. Figure 1 below gives a visual representation of the projected population growth, showing the increase from 1961 to 2013, and the future prediction in 2061.

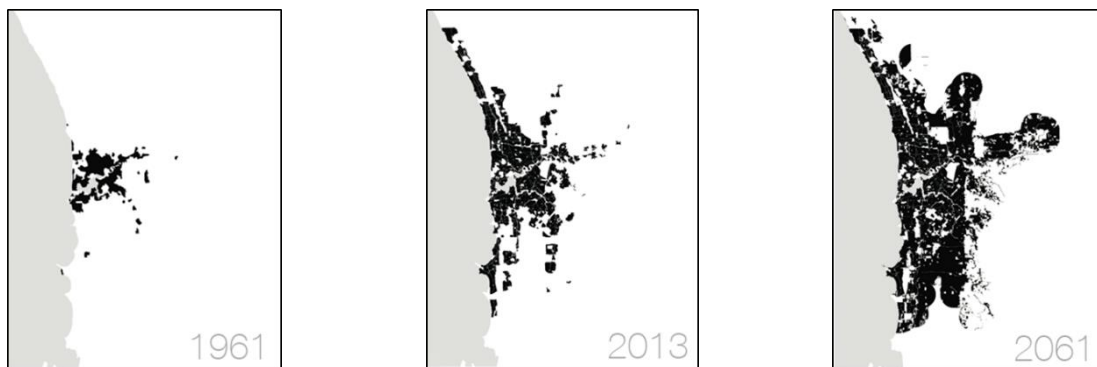

Figure 1: Urban Spread of Greater Perth (AUDRC, 2015)

Based on current trends and development patterns, Perth’s population is projected to reach 6.6 million people over the next 50 years (ABS, 2014). This will cause the suburban area to sprawl a further 1500 square kilometres as illustrated in Figure 1. This growth shows how areas on the outer of the Greater Perth region will continue to be developed. Areas currently seeing rapid growth such as Baldivis (south-west) and Ellenbrook (North) will likely continue to thrive on the expanding population. Bound by the coastline to its west, it is natural that the urban spread of Perth would continue to move further north and south, as people remain close to the coast. The areas depicted in Figure 1 prediction by 2061, also highlight expansion towards eastwards direction of Perth into areas with varying topography. As this expansion occurs, new developments and plots of land will be gradually opened to make ways to new homes to be built. This expansion is necessary to keep up with the growth of the population. The need for housing currently outweighs the supply, by roughly 30,000 in Perth alone. Strategies have been put in place by the state government to help transform the market and increase the availability

of housing, by providing incentives and schemes that allows more people to own their first home.

The state government has outlined various strategies and initiatives for the residential housing sector in the future. Short-term goals have been set to keep up with the need for housing between 2010-2020. The state government's "Affordable Housing strategy 2010-2020" outlined the goal to generate at least 20,000 additional affordable houses by 2020 (Government of WA 2010). This goal has been revised to a new target of 30,000 houses. This will be delivered through investigation and identification of options for the government and private sector to overcome some of the currently challenges met in the construction of new homes. The offsite construction emerged as a potential solution to achieve this ambitious target. The superiorities of the offsite construction techniques have been well documented in the literature mainly in terms of speed, quality, health and safety, sustainability and life cycle costing (e.g. Khalfan and Maqsood 2014; Pan and Goodier 2012; Blismas 2006; Gibb 1999) so much so that the offsite construction has been regarded the way to go for the Australian construction industry (Chandler 2014; Hampson and Brandon 2004). However, the offsite construction in the Australian housing sector has been considered a minor part (Steinhardt and Manley 2016) and only accounts for 3% of new housing in Australia (Crough 2015).

2.2. Soil and site conditions in Western Australia

Western Australia is geographically the largest state and home to a number of varying landscapes, including a diverse range of topography and soils. Currently, sites where homes have been built in Perth's inner and middle suburbs consist of relatively stable or only slightly reactive soils. With the limitations of the coastline to its west, the expansion of the greater Perth has moved north, east and south into territory with variations in the sites soils. Many of these sites are subject to reactive soils and can have serious effects on the design and construction of new homes. As a majority of homes in Perth are typically built with concrete slab floors, the behaviour of the soil where the foundations are laid on can affect the house after it has been built (BUILD, 2015). 'Reactive soil' does not directly refer to soil that is contaminated or dangerous from a chemical existence. Rather, reactive soil refers to changing moisture content due to seasonal variations causing the soil to react by shrinking or expanding. This movement of the soil can potentially affect or even undermine the structural integrity of footings, and cause the loadbearing weight of the structure to comprise the surrounding foundations. Soils with high clay content are prone to change in volume affected by the variability of the moisture content in the soil (Al-Rawas and Goosen 2006; Chen 1988). Depending on how much the soil is predicted to shift helps to measure how reactive the soil is. Following a geotechnical soil testing the house's footings and overall loading will be designed to anticipate the potential soil movement (BUILD, 2015).

To ensure suitable design and construction of footings/structure, the aforementioned soil test is usually conducted. Samples from the site are subjected to a number of tests to determine the appropriate site classification. This classification is established according to Australian Standards, more specifically AS 2870-2011: Residential slabs and footings. The rating will allow a structural engineer to assess how reactive the soil is and to design an appropriate footing system suitable for possible movement with seasonal variations. Table 1 outlines the different type of site classifications as per the Australian Standards.

Table 1: Soil Classifications in Australia (AS 2870-2011)

Classification	Reactivity	Description
Class A (0-10mm)	Stable, Non-Reactive	Minimal ground movement. Mainly sand and rock sites.
Class S (10-20mm)	Slightly Reactive	Minor ground movement may occur from changes in moisture
Class MM-D (20-40mm)	Moderately Reactive (clay or silt)	Moderate ground movement from moisture changes and soil conditions
Class H1/H1-D (40-60mm)	Highly Reactive site (clay)	High amounts of ground movement may be experienced due to changes in moisture and soil conditions
Class H2/H2-D (60-75mm)	Highly Reactive Site (clay)	Very high amounts of ground movement may occur due to changes in moisture and soil conditions
Class E/E-D (75mm+)	Extremely Reactive sites	Extreme amounts of ground movement may be experienced due to changes in moisture content and soil conditions.
Class P (approx. 70% of building sites in AUS)	Problem Sites	Load bearing capability of the soil is very poor. This may be due to a number of factors eg. Erosion, soft soils, cut/filled sites.

The ‘D’ reference in a number of these classifications signifies ‘deep’ movements in the soil as a result of deep changes in moisture presence. Data relating to the different soils over the West Australian landscape is available to give an overview of what soils are likely to be present in the newly developed areas of Greater Perth.

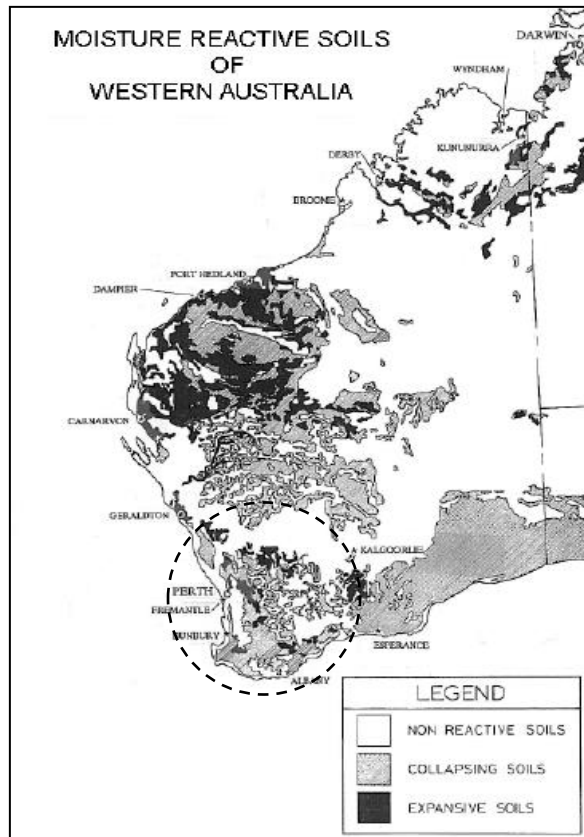

Figure 2: Soil Classification of Western Australia (Davenport 2007)

From Figure 2, it is evident that the majority of the areas immediately outside the current Perth metropolitan areas (circled) are typically considered reactive soil for development. This is

particularly but not limited to development eastwards of the current Perth metropolitan area. The soil in these areas is reactive soil (see Table 1), which means that it will be more difficult and costly to develop.

2.3 The traditional construction techniques

There are a number of housing construction methods available, but it is still the traditional techniques that are most frequently used in many parts of Australia. According to the ABS (2012), traditional masonry construction accounts for about 70% of houses constructed in Australia, as indicated in Figure 3.

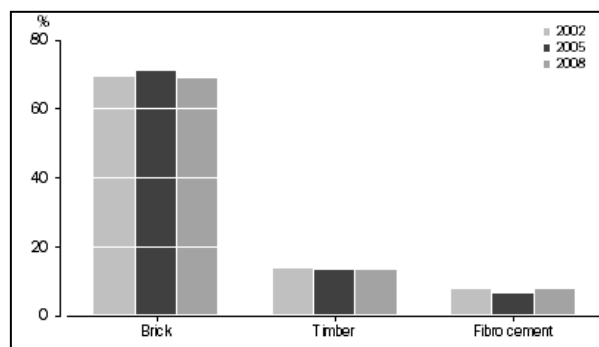

Figure 3: Dwelling Construction Materials Australia (ABS, 2012)

This indicates that although there are alternative construction methods and materials available, the traditional ‘brick and mortar home’ has been and still is the most popular choice. Briefly, the technique involves excavation on site and preparation of foundations/footings. The location of the site has an impact on the design of the footings and slab as a loadbearing element (and also the house design). Cavity brick walls are then laid by the bricklayer trade. Commonly, the roof is constructed with timber, or using prefabricated roof trusses. Once the roof is completed, then windows and doors are installed. Subsequent to this, the building is considered watertight to allow for internal finishes. Being the most common method of dwelling construction, it is a well-understood technique, which is considered more flexible in both design and construction. Having an established track record over a long period of time means that the technique is understood by designers and builders, as well as other important stakeholders such as insurers, lenders and warranty companies. Whilst the technique provides strong durability and fire protection, they are structurally heavy and transfer significant force to the foundations they are built on.

Due to the heavy nature of concrete slab and brick houses, the requirement for higher footing strength and foundation preparation can impose restrictions and costs implications. Areas that include clay soils are subject to swelling when wet and shrinking when dry (on a seasonal rotation). This creates movement beneath the footings of the buildings and requires stronger footings to reduce the effects of this movement. The cost of extra materials and labours required for larger beams, more reinforcement, thicker slab and higher concrete grade can be significant. Anecdotally, it has been said to add up to AU\$30,000 to a traditional home compared to building the same house on a flat-undisturbed site. Even on the sites with minimal extra requirement for footings, the standard design needs to allow for the weight of the brick house.

2.4. The shortage of skilled trades

Whilst there is a need for skilled trades with good understanding of the technique, the on site construction process is labour intensive by nature. Although the latest situation has shown much improvement to the on-going pressure to the skilled trades need in Western Australian construction industry, mainly due to the reduced construction works in general (Department of Employment 2016), Figure 4 depicts the mismatched between the workforce and their suitability according to construction company employers. Thus, the number/volume of the labour in the construction trades market does not necessarily correspond to the skills needed by the construction industry.

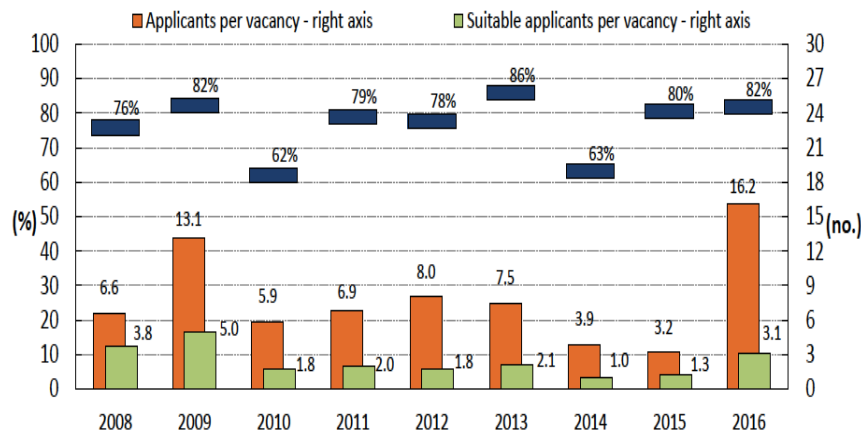

Figure 4: Suitability of construction trades in Western Australia 2015-2016 (Department of Employment 2016)

It must also be noted that the dataset presented in figure 4 above is an aggregate of the entire construction industry in Western Australia that includes Perth/Greater Perth area as well as more remote areas. As further explained by the Department of Employment (2016, p.2) in their report that “employers in metropolitan areas filled a higher proportion of vacancies and attracted more suitable applicants to vacancies than their regional counterparts”. The further away the project location from the Perth/Greater Perth metropolitan area, the more difficult it is to resource construction projects with suitable skilled trades. The implications of this are typically higher cost to bring the expertise from metropolitan areas (i.e. additional transportations, allowances, and so on) as well as potential delays due to uncertain availability of the trade workers. Whilst the current situation shows reduction in construction works including in housing sector, the longer term outlook of the sector (represented by the number of new housing) forecasts an increase in 2017-2018 further strengthening in 2018-2019 and 2019-2020 (HIFG 2016). Therefore, in the longer term, the availability of skilled trades still forms a significant factor to the housing provision in the Western Australia, even more so for more remote areas in the state.

3. RESEARCH METHODOLOGY

Having identified the challenges facing the housing sector in Western Australia, this research was set out to explore potential solutions to those challenges. As indicated in the introduction section of this paper, a significant attention was directed towards the potential of offsite construction due to the reported benefits that were found to be inline with the identified challenged facing the housing sector in Western Australia. The first step was to conduct

literature review on the housing situation in Western Australia and the potential of offsite construction overlapped with conducting pilot interviews with offsite construction players/stakeholders. These two approaches complement each other to inform the research about current practices and the latest development in offsite construction, particularly in Western Australia. Following the finalisation of the initial findings from this first step, the subsequent data collection and analysis can be designed and then carried out to find a real solution to the challenges.

Due to the nature of this first phase, i.e. to better understand current practices and the latest development, qualitative research methods have been considered appropriate. Rather than focusing on accuracies and results, the qualitative research methods aim to focus on process and discovery (Creswell, 2009). Qualitative research methods take into account the influence that the researcher has on interpreting the data. Data is typically represented from the researcher’s point of view with the researcher’s background taken into consideration, as it impacts on how the data is presented, and the structure of the research, i.e. what questions are being asked and depth of subject analysis (Groat and Wang, 2002). Qualitative research methods attempt to answer the ‘why’ questions by collecting unstructured data whilst quantitative research on the other hand attempts to answer the ‘how’ through statistical and numerical data. A number of semi-structured interviews were conducted to capture the responses of industry professionals involved in the offsite construction, particularly in Western Australia. A semi-structured interview involves the interview being partly scripted but allows for a more open flow of conversation. In comparison, a structured interview is usually completely script, and an unstructured interview the opposite, with often little more than an objective (Denzin and Lincoln, 2000). The process involved both phone and face-to-face interviews depending on the availability of the respondents. The researcher was invited to make presentation about this research to the Modular Building Committee of the Master Builder Association in Western Australia (MBAWA). The committee carries the mandate from MBAWA to collate and disseminate advances in modular building in Western Australia and beyond. Following this presentation, five offsite construction practitioners representing different modular manufacturers volunteered to be interviewed in the first phase of this research. The following Table 2 presents the profile of the interview respondents.

Table 2: Profile of the interview respondents

Respondents	Background
Respondent 1	Bus. Dev. Manager - Offsite Manufacturer
Respondent 2	Factory Manager - Offsite Manufacturer
Respondent 3	Operation Manager - Offsite Manufacturer
Respondent 4	Site Supervisor – Offsite Manufacturer
Respondent 5	Production Manager - Offsite Manufacturer

Rich data was generated from the interview process, including both notes taken by the researcher during each of the interviews and the written transcripts from the conversation. The analysis of the transcripts was then facilitated by a technique known as the content analysis technique (refer to Weber 1990). A coding process was developed to manage and structure the data and group the data into “chunks” of information (Groat and Wang, 2002). This allows the data to be sorted by theme and enables direct comparisons to be made between experienced professionals currently in the industry and the current body of literature.

4. THE PRELIMINARY FINDINGS

As mentioned above, this first phase of the research intends to shed light on the potential of offsite construction as a suitable house building method to address the challenges faced by the housing sector in Western Australia. The following subsections discuss the preliminary findings so far.

4.1. Offsite construction and soil/site conditions

From literature, a number of sites in the greater Perth region and regional areas were subject to a sloping topography and more reactive soils. As the quality and design requirements in offsite construction can easily be adjusted to cater specific needs of the project (Smith 2010), Perth modular builders have regularly overcome this issue with the lightweight and alternative foundation systems used for the homes, which causes minimal disturbance to the site. One of the main methods used to overcome the sloping sites involves building the modular homes on piles/columns/stilts to minimise the necessity for cut and fill (respondents 3, 4, 5). Due to the lightweight structure of the modules, stilts can easily be designed to support the structure and transfer the loads to the ground and is not really affected by movement of the soils if designed appropriately. The lighter weight of the offsite homes also resulted in lighter load to be transferred into the foundations and less pressure to the ground which is particularly helpful on reactive soils. Because of these load reductions, less site testing is required, making it easier and quicker to be evaluated and approved by the local authority. It was revealed that in many cases a site visit isn't really needed by the local authority for a modular home with this foundation system (respondents 1, 4). This is found rather surprising as from literature, a potential compliance issue and hence final certification with offsite housing has been indicated (Blismas 2006). This issue can be linked with the lack of specific building codes and standards for offsite buildings in Australia. From the interviews, it was discovered that compliance and final certification was not an issue in Western Australia as all finished buildings must be compliance with the Building Code of Australia (BCA) and Australian Standards with standard contracts, completion certificates and warranties used are the same as traditional houses without any additional requirements (respondents 1, 2, 5).

The modular homes are flexible in design and allow a number of different foundation systems to be adopted based on the site, client request and engineering requirements. For most modular houses on flat sites, the main requirement for the ground condition/foundation is 150 KPa (respondent 5). If the soil is non-reactive there may even be no requirement for additional footing, as the weight of the building would typically reduce the possibility of settlement but suffice to keep it in place as long as the ground was compacted to 150 KPa. Pile footings are not uncommon in modular builds and present a cost effective and durable support solution. In comparison to a more traditional footing, pile footings allow soil movement around the footing. In more reactive soils this is particularly useful. Pile footings are relatively quick and inexpensive to do. They also require less formwork and materials, making them a popular choice especially in modular homes in reactive soils (respondent 3). The on-going issues that are present with strip footings can be avoided using pile footings. In strip footing, if happened, moisture build-up will be unable to travel around the footing and can only drain away slowly over time. This build up causes pressure on the footing and will cause it to eventually crack. In the case of soil heave, using a pile footing allows the soil heave to go around the pile footing and move with the soil eliminating the issue of pressure building up against the footing and cracking (Al-Rawas and Goosen 2006; Chen 1988). The use of piles in lightweight structures

to counter issues with reactive soils have been well tested and documented (e.g. Ismail and Shahin 2012; Nussier *et al.* 2009).

4.2. Offsite construction and the availability of skilled trades

A majority of the modular builders currently operating in Perth provide service to the outer Perth region and in country areas (mainly the south-west, inland/east and north of Perth metropolitan area). These more remote areas have less access to skilled trades and builders in comparison with the metro area due to location (Department of Trade 2016) and therefore many clients are seeking for an alternative method. Due to the lack of skilled trades and builders in the more remote parts of Western Australia, modular is becoming a more attractive construction method (respondents 1, 3, 4, 5).

For homeowners in these more remote parts of Western Australia, the availability of skilled trades and builders are just one issue. Even if they manage to find these skilled trades and builders, the queuing time can be unreasonably long due to the lack of availability. The limited skilled trades and builders that are willing/able to serve these more remote areas will typically have a number of jobs already lined up and bringing the skilled trades together at the right time to be involved in the house building can be an issue. Therefore, the waiting time can easily be in excess of two years between the initial discussion/agreement and to actually get the house started on site (respondent 3). In comparison, by building the homes offsite, all these skilled trades will be in one location under a controlled working environment (respondents 1, 5). This advantage from offsite construction confirmed what has been identified in the literature (Blismas 2006). There was also the opportunity to utilise workers who are not fully qualified (such as trade assistants, apprentices or labourer) under the supervision of qualified trades with clear standardised working procedures (respondent 2) and finely broken down repetitive tasks (respondent 1). In terms of alleviating skills shortage in the construction industry, off-site construction allows the use of less skilled labour due to its predictability and tasks required with efficiencies gained through the controlled environment typically reduce the number of skilled trades required (Boyd *et al.* 2013, p.54).

Whilst picking up speed from the repetitiveness of the tasks, in offsite home building, the prefabrication can be started even before the building permission is sought (respondents 3, 4) Therefore, it will usually take no more than 6 months and as little as 3 months to be designed, prefabricated and installed on site. Once the house is built in the factory, depending on the level of onsite works to be completed around the house, it can be completed and handed over within a matter of days (respondents 2, 3). This has been widely recognised as one of the main benefits of offsite construction, to overlap off- and on-site activities that would have been done sequentially in traditional in-situ method to reduce duration (Gibb 1999).

The more remote location of these projects also means a large increase in costs for the skilled trades and builders to go to the site daily to build. An example provided by one of the interviewees of this is an offsite house building in Yallingup which is located about 270 Km southwest of Perth. The nearest town to source home builder would be a small town called Bunbury which is still about 100 Km away from Yallingup. In many other remote areas the skilled trades and builders may even be further away, meaning daily travel or even temporary accommodation will be needed. A majority of builders will travel to and from the work site each day, not only creating extra travel expenses, but also minimising the amount of time to build on site each day (Smith 2010). The cost for this travel time to get to the jobs or

accommodate the trades and workers is reflected in the cost of building the traditional in-situ homes in these more remote areas (respondents 1, 4). Additional to the travel expenses is the cost of materials. Respondent 3 stated how the average price of materials in regional Western Australia could be 30% more than if they were purchased in Perth. Buying an offsite home from a Perth manufacturer essentially means that the clients are paying the same price for materials as if the house were built in Perth, with the only difference being transport costs. The transportation cost itself can be substantial but the cost in total will typically be lower than bringing skilled trades and builders (as well as materials) into remote locations. This was found in line with Boyd *et al.* (2013) that concluded about the potential saving by using off-site construction in more remote locations due to the typical involvement of far fewer staff during delivery that resolves site issues such as availability, accommodations, and costs.

5. CONCLUSIONS AND THE WAY FORWARD

Fuelled by the expansion of the city, new houses are being built and will continue to be built outside the Perth metropolitan area. The house building activities in these more remote areas have been reported facing steep sloping topography and reactive soil conditions as well as experiencing difficulties stemming from the availability of skilled trades and builders in the areas that has increased the costs of building houses as well as resulted in longer waiting periods. This research was set up to explore the potential of offsite construction techniques in alleviating these challenges facing the house building in Western Australia. A series of pilot interviews involving offsite construction practitioners has been conducted, transcribed, analysed and the preliminary findings reported in this paper. It was revealed that the offsite construction is gaining popularity in these more remote areas in the Western Australia despite the continuous popularity of the more traditional brick and mortar houses in the state. The procedures for completion hand over and final certification was found to be identical to that of traditional houses. Thus, from the findings so far, it can be concluded that offsite housing can really be a serious contender as an alternative construction method to alleviate issues and challenges in Western Australia housing sector. The preliminary findings have provided a real-life case study, i.e. a real evidence, of the remote areas to confirm what have been expected in the current literature (which are logical but mainly done through extrapolation). Whilst provided a real potential for solution in responding to the housing challenges in Western Australia, the wider impact and contribution of the preliminary findings presented here also provide evidence that can be used to further explore the benefits of offsite construction in resolving challenges faced by construction projects in remote areas. These findings are context-bound and uncorrelated. Further work is needed in this area, including cross-case comparisons to support internal/external consistency and reliability/validity checking.

The next phase of this research will involve selecting suitable cases to quantify the actual benefits of offsite construction in house building in Western Australia. This will include peripheral but relevant issues such as sustainability, health and safety, logistics (particularly transporting the finished panels/modules from the manufacturing yard to the assembly site), and quality control. Findings from the next phase of this research will be reported in subsequent publications.

6. REFERENCES

- Al-Rawas, A., and Goosen, M. F. A. (2006). *Reactive soils, recent advances in characterization and treatment*, Taylor & Francis, London.
- Australian Bureau of Statistics. (2012), “Private Sector Construction Industry, Australia, 2011-2012”, URL: <http://www.abs.gov.au/ausstats/abs@.nsf/Latestproducts/8772>, viewed: 15 August 2015.
- Australian Bureau of Statistics. (2014), “Regional Population Growth, 2013-2014”, URL: <http://www.abs.gov.au/ausstats/abs@.nsf/Latestproducts/3218>, viewed: 15 August 2015.
- AUDRC (2015), “Future Perth: 900,000 new homes without the urban sprawl”, Australian Urban Design Research Centre, URL: <http://www.perthnow.com.au/news/special-features/future-perth-900000-new-homes-without-the-urban-sprawl/story-fknbeni-1227098457513>, viewed 2 August 2015.
- Boyd, N., Khalfan, M. M. A. and Maqsood, T. (2013), “Off-site construction of apartment buildings”, *Journal of Architectural Engineering*, **19**(1), pp. 51–57.
- BUILD (2015), “Building on reactive soil sites”, URL: <http://www.build.com.au/building-reactive-soil-sites>, viewed 2 August 2015.
- Chandler, D. (2014), “A case for an Australian Construction Strategy”, Commonwealth Government Productivity and Industry Discussion Paper, 2014, <http://constructionedge.com.au/?p=1290>, viewed: 9 August 2015.
- Chen, F. H. (1988). *Foundations on reactive soils*, Elsevier, New York.
- Costello, L. (2009), ‘Urban-rural migration: housing availability and affordability’, *Australian Geographer*, **40**(2), pp. 219–233.
- Creswell, J. W. (2009), *Research Design: Qualitative, Quantitative and Mixed Methods Approaches*, Sage Publishers Inc., Thousand Oaks, CA.
- Crough, D. (2015), “Key findings from the manufacturing excellence taskforce Australia”, paper presented at the prefabAUS 2015 Conference: IndustryTransformation, Melbourne.
- Davenport, F. (2007), ‘Problem Soils - A West Australian Perspective’, *Australian Geomechanics*, **42**(3), pp 1-20.
- Denzin, N. K., and Lincoln, Y. S. (2000), *Handbook of Qualitative Research*, 2nd ed, Sage Publications Inc., Thousand Oaks, CA.
- Gibb, A. G. F. (1999), *Offsite Fabrication: Prefabrication, Pre-assembly and Modularisation*, Whittles Publishing, Caithness, UK.
- Government of Western Australia (2010), “Affordable Housing Strategy 2010-202 Opening doors to Affordable Housing,” Perth, URL: http://www.dhw.wa.gov.au/HousingDocuments/AHS_Report_final.pdf, viewed: 22 August 2015.
- Groat, Linda, and David Wang. 2002. *Architectural Research Methods*. New York: John Wiley and Sons, Inc.
- Goulding, J., Rahimian, F. P., Arif, M. and Sharp, M. D. (2015), “New offsite production and business models in construction: priorities for the future research agenda”, *Architectural Engineering and Design Management*, **11**(3), pp. 163-184.
- Hampson, K. and Brandon, P. (2004), “Construction 2020: A Vision for Australia’s Property and Construction Industry”, *Cooperative Research Centre for Construction Innovation*, Brisbane, Australia.
- Ismail, M. and Shahin, M. (2012), ‘Numerical modeling of granular pileanchor foundations (GPAF) in reactive soils’, *International Journal of Geotechnical Engineering*, **6**(2), pp. 149-155.
- Khalfan, M. M. A. and Maqsood, T. (2014), “Current State of Off-Site Manufacturing in Australian and Chinese Residential Construction”, *Journal of Construction Engineering*, <http://dx.doi.org/10.1155/2014/164863>.
- McKenzie, F.M. H. and Rowley, S. (2013), ‘Housing market failure in a booming economy’, *Housing Studies*, **28**(3), pp.373-388.
- MRSC (2015), Infill Development: Completing the Community Fabric. Viewed July 20th 2015. <http://mrsc.org/Home/Explore-Topics/Planning/Development-Types-and-Land-Uses/Infill-Development-Completing-the-Community-Fabric.aspx>, viewed: 15 August 2015.
- Nusier, O. K., Alawneh, A. S., and Abdullatit, B. M. (2009). “Small-scale micropiles to control heave on reactive clays.” *Ground Improvement*, **162**(1), 27-35.
- Pan, W. and Goodier, C. (2012), “House-building business models and off-site construction take-up,” *Journal of Architectural Engineering*, **18**(2), pp. 84–93.
- Smith, R. E. (2010), *Prefab Architecture: A Guide to Modular Design and Construction*, John Wiley & Sons, New Jersey.
- Steinhardt, D. A and Manley, K. (2016), “Adoption of prefabricated housing—the role of country context”, *Sustainable Cities and Society*, **22** (2016), pp. 126–135.
- Weber, R. P. (1990), *Basic Content Analysis*, 2nd ed., SAGE Publications, London

OFFSITE CONSTRUCTION: AN OPPORTUNITY FOR IMPROVING RISK MANAGEMENT

L. Zhang¹, F. Pour Rahimian¹, A. Agapiou¹ and J. Goulding²

1 Department of Architecture, University of Strathclyde, Glasgow, UK.

2 Department of Architecture and Built Environment, Northumbria University, Newcastle, UK.

Email: lin.zhang.100@strath.ac.uk

Abstract: Offsite construction has now reached sufficient maturity to evidence significant improvements for construction projects. However, as this relatively new methodology to ‘traditional’ construction approaches, a number of new internal, external and project risks need to be evaluated; in particular, the disparities of traditional construction risk with offsite construction risk. This poses significant challenges, as a deeper and more meaningful understanding is often highly dependent on ‘conventional thinking’ versus ‘new/innovative thinking’ required for offsite. Acknowledging this tension, this research evaluates the different points between traditional construction risk and offsite construction risk. This paper proffers initial findings based on a literature review using qualitative analysis. Findings indicate that risk definition and assessment of construction process still needs further focus; particularly on the unique offsite processes, where risk categorisation requires additional work to support intrinsic verifiable solutions.

Keywords: Construction Process, Offsite Construction, Risk Analysis, Risk Management, Traditional Construction

1. INTRODUCTION

Offsite construction – often called modular construction, has been proposed for many years (Doran & Giannakis, 2011). This is fundamentally different from traditional construction as it involves processes drawn from other industries, most notably manufacturing. Offsite construction also includes several variants, from hybrid systems, through to full offsite module prefabrication and subsequent *in situ* module installation (Nadim & Goulding, 2009). Compared to traditional construction, offsite construction provides significant savings in project cost, reductions in time, improved quality control thresholds, lower waste, health and safety improvement/hazard mitigation (Li *et al.*, 2013). However, from a risk management perspective, the different processes involved in offsite construction are significantly different to those employed in traditional construction processes. Given this, there is an intrinsic need to evaluate these risks cognisant of the increased pervasiveness of offsite construction in the market.

The aim of this research is to identify the main difference between traditional construction risk and offsite construction risk, in order to develop a risk comparison framework between these two construction methods. To achieve this aim, this paper identifies construction project risk through an evaluation of previous studies in extant literature – focusing particularly on: internal risk, external risk and project risk.

The research methodological approach employed NVivo, as this is particularly efficacious for qualitative data analysis (Leech & Onwuegbuzie, 2011). Data through literature from both traditional construction and offsite construction was captured for analysis in order to help identify the risk in both traditional construction and offsite construction. NVivo provides a systematic process for initiating data analysis (Lu & Yuan, 2011). Main nodes and sub nodes

were designed for management of the categories or themes. The main node was divided into traditional construction risk and offsite construction risk. Zavadskas *et al.* (2010) defined risk in three kinds: internal risk, external risk, and project risk. As the research focus is on risk identification, both of main nodes (traditional and offsite) included three sub nodes: internal risk, external risk, and project risk. All articles were coded paragraph-by-paragraph through NVivo. From the coding analysis, three frameworks were developed and presented for discussion.

2.1 Traditional construction risk

Schatteman *et al.* (2008) identified one risk would cause at least one project delay. As resources were often shared among different projects, this disruption could lead to the whole project moratorium. Kaplinski (2013) identified that the risk would have the significant influence during the managing process. It also influenced operational strategy. Nonetheless, McGeorge and Zou (2012) pointed out traditional construction used few formal techniques of risk analysis and management due to lack of familiarity. For instance, in the Belgian traditional construction industry, the third major cause of company bankruptcies was the lack of an effective risk management system and insufficient planning (Schatteman *et al.*, 2008). Besides, communication was another key word for project participants, lack of communication may cause early warning measures and mitigating strategies could not be set up in time, which resulting wrong decision making during the advance.

Although many articles identified risk, and indicated the importance of risk, risk management was still insufficient for industrial use (Olsson, 2007). Olsson (2007) believed the reason was that existing risk management process only concern dynamic and structural risk, and ignore the highly dynamic and high behavioural risk. To solve the risk management problem, several risk management tool was developed. Li *et al.* (2013) introduced a computerised supported risk management system for risk identification, analysis, and quantification. A multi-agent system (MAS) was developed to simulate risk allocation and the cost sharing process in the project. An advanced programmatic risk analysis and management model (APRAM) was utilised for managing scheduling and cost.

2.2 Traditional construction risk management

The advantage of using construction risk management was providing understandable and controllable risks in the projects. However, the contractors responded that the main reason they implemented construction risk management was ensuring an adequate profit and minimise loss during the projects (McGeorge & Zou, 2012). Dziadosz and Rejment (2015) worried that although many authors considered the phenomenon of risk, and many articles presented risk identification and classification in traditional construction, a few papers considered methodology to quantify and explain the risk.

Dziadosz and Rejment (2015) demonstrated that risk management for traditional construction was to identify the undesirable factors, determine the impact on various elements of the construction project, and develop a solution to respond the factors. The risk might change during the project lifecycle, which causes it becomes a cumbersome task (Zavadskas *et al.*, 2010). Risk management was designated as one of the eight main areas by the Project Management Institute (Dziadosz & Rejment, 2015).

To analyse the risk in construction projects, risk assessment needs to be settled. Schatteman *et al.* (2008) defined risk into six main categories: environment, organisation, consumer goods, workforce, machines, and subcontractors. The current tool like the probabilistic methods and the probability theory, the computer simulation, the sensitivity analysis, the multi-criteria decision-making methods, the cost-benefit analysis during risk control, the decision trees, the methods of operations research and econometrics, the fuzzy sets, the neural networks (incidental). These tools could estimate the risk factors of the project (Dziadosz & Rejment, 2015).

There were four methods to solve risk in the project: risk avoidance, risk reduction, risk transfer, and risk retention. For the construction project, risk avoidance was generally recognised to be impractical, because the risk in the construction project was unavoidable. Risk reduction like the use of alternative contract strategies, different methods of construction, project redesign, more detailed and further in-depth site investigations. Risk transfer like sharing the responsibility of the participant like client, contractor, subcontractor, design team, insurer and surety. Risk retention would become the last method if any other methods above were not applicable (McGeorge & Zou, 2012).

2.3 Offsite construction risk

Li *et al.* (2013) believed offsite risk was constituted by following parts: engineering, occupational and cultural, socioeconomic, financial.

Cost: Li *et al.* (2014) pointed out that project team prefers to have standard processes which would simplify the overall construction process. It also reduced waste and resource. Offsite construction could reduce the cost of the construction project, which reduced the burden during the economic downturn time (Tam *et al.*, 2007).

Although offsite construction could reduce building maintain costs, high initial capital expenditures, high design and transport costs deter developer to utilise it (Arif *et al.*, 2009). Blismas *et al.* (2005) worried that offsite construction always magnify the advantage of material, labour and transportation cost reduction, and neglect other cost related items such as site facilities, crane use and rectification of works.

For example, during offsite construction, manufactory cost must be considered as well, whereas developer had to compress their costs before the construction began (Li *et al.*, 2014). Blismas *et al.* (2006) pointed out as the high cost of the initial investment, many construction industries refused to fully accept offsite construction.

Environment: Hall (2010) found that offsite construction brings less waste and less impact on the environment. Li *et al.* (2016) agreed with the view, and considered offsite construction reduce the material waste, air and water pollution, dust and noise, and overall energy costs, that onsite environment could improve. Tam *et al.* (2007) determined that offsite construction was one of the ways to reduce long-term waste.

Time: Li *et al.* (2014) worried about the traditional construction project, especially for airports, roads, rail and prison projects, too many participants working onsite at the same time may cause jam and delay. Hashemi (2015) investigated several construction practitioners, and give a solution for the risk, which was offsite construction.

Quality: Taylor (2010) indicated that well engineered offsite construction project could also produce high performance products by using innovative materials and designs. Nawi *et al.* (2014) agreed offsite can improve the quality of construction projects, and certified that the offsite construction building can perform reliably, be more easily maintained and require fewer spare parts.

Culture: Offsite construction has been valued by many governments. Goulding *et al.*, (2012) found that Japanese housebuilders using offsite construction to produce attractive, customised and affordable homes. Li *et al.* (2013) demonstrated that offsite construction was widely accepted in North America for accommodation building construction as an efficient construction method. Blismas *et al.* (2006) indicated that offsite construction would become the main point of improving the Australian construction industry in the next ten years.

However, offsite construction was still not be attended by many housebuilders. Taylor (2010) reported that offsite construction accounted for approximately two percent of UK construction, and in top 100 housebuilders, few of them used offsite construction as the main construction method. There was still a bias that offsite construction could only produce the low-cost product. However, Nawi *et al.* (2014) considered that if there were excellence design for the offsite construction project, it could provide a high level of product.

Flexibility: Blismas *et al.* (2005) considered that although offsite construction could provide the design and specification before construction process, many clients and designers may change their demand during the construction process. Tam *et al.* (2007) agreed that, and pointed out the design of traditional construction had not frozen in the development stage, which would affect the adoption of offsite construction. Nevertheless, many construction parties considered the inefficient design data and weak communication for the participants, and tried to use offsite construction to solve this problem (Li *et al.*, 2016).

Health and safety: McKay (2010) considered if offsite construction participants understand more about the materials and components during the offsite construction project, safety, health, productivity and quality performance should all increase. Azman *et al.* (2010) gave an example that offsite could improve the safety for the construction project: when working in a prison, tradition construction participants have to be vetted, and have to be escorted to protect their safety. Offsite construction could easily send employees for assembly, which reduces the cost of security. Li *et al.* (2016) proved that offsite construction gives more controlled conditions for weather, quality control, improved supervision of labour, easier access to tools, and fewer material deliveries.

Most offsite construction used larger and heavier components for onsite assembly, which means the regular mobile cranes could not be suitable for the offsite components (Li *et al.*, 2011). Also, the heavy offsite construction product increased hazard in the event of the earthquake (Hashemi, 2015).

Work condition: As the offsite construction project always hire only one company for construction, traditional construction like variable subcontract is no longer needed, which provide better job security for workers (Nadim & Goulding, 2011). Li *et al.* (2016) introduced that onsite materials storage area could be reduced as many materials stored inside the manufactory.

Knowledge: Goulding *et al.* (2012) considered that the lack of adequate knowledge was the main reason constraining offsite construction development. Research had shown that architects needed to know more about offsite construction (Hashemi, 2015).

Supply chain: Arif *et al.* (2009) identified that import offsite construction products from foreign country were led to low quality and non-compliance to standards. Blismas *et al.* (2005) emphasised that offsite construction developer only prefers the supplier who has a high degree of trust.

As such these theories have been qualitatively analysed, and three frameworks have been developed to compare traditional construction risk with offsite construction risk, the main these of which are as follows: internal risk, external risk, and project risk.

3.1 Internal risk comparison

Internal risk was the risk which is influenced by project participants. It included like: resource risk, project member risk, construction site risk, documents and information risk (Zavadskas *et al.*, 2010).

Table 1: Internal risk comparison

	Traditional construction	Offsite construction
Resource risk	Many materials are small package	More large load supply needs to be transported (Aburas, 2011)
Project member risk	The client can place different order from multiple suppliers	The client only place order from the single-point supplier who has the high degree of trust (Blismas <i>et al.</i> , 2005)
Construction site risk	More possible congestion in construction site	Less possible congestion on construction site (McKay, 2010)
	Onsite environment has more hazard in control and design process	Factory environments could provide better control and design workplace (Meiling, 2010)
Documents and information risk	More information confusion during construction process	Less information confusion during construction process (Azhar, 2011)

3.2 External risk comparison

External risk was the risk which the risk management team could not control. It included like: political risk, economic risk, social risk, weather risk (Zavadskas *et al.*, 2010).

Table 2: External risk comparison

	Traditional construction	Offsite construction
Political risk	Traditional construction is a normal method for construction	Government encourage to use offsite construction (Nadim & Goulding, 2009)
Economic risk	Later income generation for clients	Clients get income earlier (Arif <i>et al.</i>, 2009)

	More waste and more impact on the environment	Less waste and less impact on the environment (Jaillon <i>et al.</i>, 2009)
Social risk	Society agrees that traditional construction can build a variety of building	Society bias against offsite construction that it can only provide low-cost building (Lu, 2007)
Weather risk	Hard to operate in bad weather	Compensate for local weather conditions (Lu & Liska, 2008)

3.3 Project risk comparison

Project risk was the risk which only happens during the construction. It included like: time risk, cost risk, work quality, construction risk, technological risk (Zavadskas *et al.*, 2010).

Table 3: Project risk comparison

	Traditional construction	Offsite construction
Time risk	Lower speed of construction	Higher speed of construction (Goodier & Gibb, 2007)
	The process of construction has to step by step	Allow onsite building and offsite manufacturing run at the same time (Vernikos <i>et al.</i>, 2012)
Cost risk	Higher site-related costs	Lower site-related costs (Boyd <i>et al.</i>, 2012)
	Lower initial capital outlay, lower design and transport costs	Higher initial capital outlay, higher design and transport costs (Pan & Goodier, 2011)
Work quality	Complicated construction process	Streamline the overall construction process (Aburas, 2011)
	Harder to maintain and require more spare parts	Easier to maintain and require fewer spare parts (Alvanchi <i>et al.</i>, 2011)
Construction risk	More construction delay or changes in the work	Less construction delay or changes in the work (Pan & Sidwell, 2011)
	The design has not frozen in the development stage	The design has frozen in the development stage (Li <i>et al.</i> , 2011)
Technological risk	Have a perennial technology development	Lack of adequate knowledge of offsite construction (Mao <i>et al.</i> , 2013)

From the frame above several conclusions can be defined: 1) offsite construction could have more advantage than traditional construction, especially in external part, 2) the main risk of offsite construction is not flexible, especially in design stage and transport stage, 3) offsite construction participants need much higher education level than traditional construction's requirements, which obstruct the development of offsite construction.

This research was motivated by the very limited use of offsite construction in construction projects. Research findings indicate that offsite construction could be a potential solution to mitigate current construction risks, especially in cost reduction, pace improvement, and quality assurance. However, offsite construction brings several new construction risks that should be taken into account.

4. CONCLUSION

The research presents a characterization of the research which is in progress at the moment and has the purpose of identifying the difference between traditional construction risk and offsite construction risk. It also presents the barriers that offsite construction adoption. However, the solution of these risks has not been discussed, which requires further investigation. Further information needs to be collected and analysed through the data from the construction site and the professional. Due to the difference of national policy, human environment, and architectural background, offsite construction risks may be distinct in differing countries. Given this, at this juncture, no direct assumptions or generalisations can be drawn until finer granularity cross comparisons have been undertaken. That being said, these findings present new insight and understanding in this unfolding area of research.

5. REFERENCE

- Aburas, H. (2011). Off-site construction in Saudi Arabia: the way forward. *Journal of Architectural Engineering*, 17(4), 122-124.
- Alvanchi, A., Azimi, R., Lee, S., AbouRizk, S. M., & Zubick, P. (2011). Off-site construction planning using discrete event simulation. *Journal of Architectural Engineering*, 18(2), 114-122.
- Arif, M., Blismas, N., & Wakefield, R. (2009). Drivers, constraints and the future of offsite manufacture in Australia. *Construction innovation*, 9(1), 72-83.
- Azhar, S. (2011). Building information modeling (BIM): Trends, benefits, risks, and challenges for the AEC industry. *Leadership and management in engineering*, 11(3), 241-252.
- Azman, M., Ahamad, M., Majid, T., & Hanafi, M. (2010). *Perspective of Malaysian industrialized building system on the modern method of construction*. Paper presented at the 11th Asia Pacific Industrial Engineering and Management Systems Conference, Melaka, Malaysia.
- Blismas, N., Pasquire, C., & Gibb, A. (2006). Benefit evaluation for off-site production in construction. *Construction Management and Economics*, 24(2), 121-130.
- Blismas, N. G., Pendlebury, M., Gibb, A., & Pasquire, C. (2005). Constraints to the use of off-site production on construction projects. *Architectural Engineering and Design Management*, 1(3), 153-162.
- Boyd, N., Khalfan, M. M., & Maqsood, T. (2012). Off-site construction of apartment buildings. *Journal of Architectural Engineering*, 19(1), 51-57.
- Doran, D., & Giannakis, M. (2011). An examination of a modular supply chain: a construction sector perspective. *Supply Chain Management: An International Journal*, 16(4), 260-270.
- Dziadosz, A., & Rejment, M. (2015). Risk Analysis in Construction Project-Chosen Methods. *Procedia Engineering*, 122, 258-265.
- Goodier, C., & Gibb, A. (2007). Future opportunities for offsite in the UK. *Construction Management and Economics*, 25(6), 585-595.
- Goulding, J. S., Pour-rahimian, F., Arif, M., & Sharp, M. (2012). Offsite construction: strategic priorities for shaping the future research agenda. *Journal of Architectoni. ca*, 1(1), 62-73.
- Hall, M. R. (2010). *Materials for energy efficiency and thermal comfort in buildings*: Elsevier.
- Hashemi, A. (2015). Offsite Manufacturing: A Survey on the Current Status and Risks of Offsite Construction in Iran.
- Jaillon, L., Poon, C.-S., & Chiang, Y. (2009). Quantifying the waste reduction potential of using prefabrication in building construction in Hong Kong. *Waste Management*, 29(1), 309-320.
- Kaplinski, O. (2013). Risk management of construction works by means of the utility theory: a case study. *Procedia Engineering*, 57, 533-539.
- Leech, N. L., & Onwuegbuzie, A. J. (2011). Beyond constant comparison qualitative data analysis: Using NVivo. *School Psychology Quarterly*, 26(1), 70.
- Li, C. Z., Hong, J., Xue, F., Shen, G. Q., Xu, X., & Mok, M. K. (2016). Schedule risks in prefabrication housing production in Hong Kong: a social network analysis. *Journal of Cleaner Production*, 134, 482-494.
- Li, H., Guo, H., Skitmore, M., Huang, T., Chan, K., & Chan, G. (2011). Rethinking prefabricated construction management using the VP-based IKEA model in Hong Kong. *Construction Management and Economics*, 29(3), 233-245.

- Li, H. X., Al-Hussein, M., Lei, Z., & Ajweh, Z. (2013). Risk identification and assessment of modular construction utilizing fuzzy analytic hierarchy process (AHP) and simulation. *Canadian Journal of Civil Engineering*, 40(12), 1184-1195.
- Li, Z., Shen, G. Q., & Xue, X. (2014). Critical review of the research on the management of prefabricated construction. *Habitat international*, 43, 240-249.
- Lu, N. (2007). Investigation of Designers' and General Contractors' Perceptions of Offsite Construction Techniques in the United States Construction Industry.
- Lu, N., & Liska, R. W. (2008). Designers' and general contractors' perceptions of offsite construction techniques in the United State construction industry. *International journal of construction education and research*, 4(3), 177-188.
- Lu, W., & Yuan, H. (2011). A framework for understanding waste management studies in construction. *Waste Management*, 31(6), 1252-1260.
- Mao, C., Shen, Q., Pan, W., & Ye, K. (2013). Major Barriers to Off-Site Construction: The Developer's Perspective in China. *Journal of Management in Engineering*, 31(3), 04014043.
- McGeorge, D., & Zou, P. X. (2012). *Construction management: new directions*: John Wiley & Sons.
- McKay, L. J. (2010). *The effect of offsite construction on occupational health and safety*. © Lawrence J. McKay.
- Meiling, J. (2010). *Continuous improvement and experience feedback in off-site construction: timber-framed module prefabrication*. Luleå tekniska universitet.
- Nadim, W., & Goulding, J. S. (2009). Offsite production in the UK: The construction industry and academia. *Architectural Engineering and Design Management*, 5(3), 136-152.
- Nadim, W., & Goulding, J. S. (2011). Offsite production: a model for building down barriers: A European construction industry perspective. *Engineering, Construction and Architectural Management*, 18(1), 82-101.
- Nawi, M., Osman, W. N., & Che-Ani, A. I. (2014). Key factors for integrated project team delivery: A proposed study in IBS Malaysian construction projects. *Advances in Environmental Biology*, 1868-1873.
- Olsson, R. (2007). In search of opportunity management: Is the risk management process enough? *International Journal of Project Management*, 25(8), 745-752.
- Pan, W., & Goodier, C. (2011). House-building business models and off-site construction take-up. *Journal of Architectural Engineering*, 18(2), 84-93.
- Pan, W., & Sidwell, R. (2011). Demystifying the cost barriers to offsite construction in the UK. *Construction Management and Economics*, 29(11), 1081-1099.
- Schatteman, D., Herroelen, W., Van de Vonder, S., & Boone, A. (2008). Methodology for integrated risk management and proactive scheduling of construction projects. *Journal of Construction Engineering and Management*, 134(11), 885-893.
- Tam, V. W., Tam, C. M., Zeng, S., & Ng, W. C. (2007). Towards adoption of prefabrication in construction. *Building and environment*, 42(10), 3642-3654.
- Taylor, M. D. (2010). A definition and valuation of the UK offsite construction sector. *Construction Management and Economics*, 28(8), 885-896.
- Vernikos, V. K., Goodier, C. I., Gibb, A. G., Robery, P., & Broyd, T. (2012). Realising offsite construction and standardisation within a leading UK infrastructure consultancy.
- Zavadskas, E. K., Turskis, Z., & Tamošaitiene, J. (2010). Risk assessment of construction projects. *Journal of civil engineering and management*, 16(1), 33-46.

W122: PUBLIC PRIVATE PARTNERSHIPS

CRITICAL SUCCESS FACTORS FOR PUBLIC PRIVATE PARTNERSHIP PROJECTS IN DEVELOPING COUNTRIES: CASE OF TURKEY

B. Ozorhon, E. Durna and S. Caglayan

Department of Civil Engineering, Bogazici University, Bebek, 34342, Istanbul, Turkey

Email: beliz.ozorhon@boun.edu.tr, elif.durna@boun.edu.tr, semih.caglayan@boun.edu.tr

Abstract: Public Private Partnerships (PPPs) have evolved in both developed and developing countries as a significant procurement method in providing public services. Regarding the size and complexity of PPP projects, successful management of those projects is crucial. This study investigates the critical success factors of PPP investments in developing countries. In this respect, based on an extensive literature survey, an initial list consisting of 73 CSFs was prepared and then those factors were distilled into 23 CSFs through interviews with a team of experts comprising two experienced civil engineers and one civil engineering professor. A questionnaire survey was conducted to analyse the impact of those factors on the PPP performance. The respondents were asked to evaluate the importance levels of the CSFs based on a five-point Likert scale. The data is collected from 82 client and contracting organizations representing public and private sector in Turkey. Various types of statistical analysis were undertaken on the collected data, including descriptive analysis, analysis of variance (ANOVA), and factor analysis using the SPSS. The statistical analysis results show that favourable legal framework; detailed/clear project identification; and extensive, reasonable cost-benefit assessment are the most significant drivers of success, whereas effective client consulting; simple structure of project organization; and wide client acceptance are less significant. Factor analysis is intended to explore and detect underlying relationships among the factors, and describe them in fewer, but more concise and comprehensive words. The results of factor analysis suggest five dimensions, namely project finance, project management, operational factors, procurement, and organizational factors. Findings of this study are expected to help both public sector in terms of focusing on legal issues to enable better operation and also the contractors in terms of reflecting on their capabilities to better manage large scale projects.

Keywords: Critical Success Factors, Factor Analysis, Procurement, Project Management, Public Private Partnerships

1. INTRODUCTION

In the last quarter of the 20th century, changes and interactions in economic, social, and political meaning have resulted in some changes in the role of the state in infrastructure services, which involves transformation from the service-producing and operating state understanding to policy maker and regulator state understanding (Ministry of Development, 2012). Search for new approaches in procurement of projects led Public-Private Partnerships (PPPs) to become well-known in the public sector which has the largest capital project spending (Amponsah, 2010). PPPs allow the public and private sectors to share the risks and rewards together. The National Council for Public-Private Partnership defines a PPP as a “contractual arrangement between a public sector agency and a for-profit private sector developer, whereby resources and risks are shared for the purpose of delivery of a public service or development of public infrastructure” (Li and Akintoye, 2003).

Considering the increasing interest in PPP since the late 1990s, many empirical and non-empirical studies on various dimensions of PPP have been conducted (Tang et al., 2010). Among these, the most widely investigated aspects have been relationship management (e.g.,

Zhang and Kumaraswamy, 2001); risk management (e.g., Akintoye et al., 1998) and financing models (e.g., Shen and Wu, 2005; Ng et al., 2007). Due to the complexity of PPP projects, it is critical to complete them in a successful manner. Another group of studies have focused on identifying the critical success factors (CSFs) (e.g., Jefferies et al., 2002; Amponsah, 2010). Studies on the CSFs are newer compared to the other studies on PPPs, yet very significant, especially in developing countries, where there is a substantial amount of investment in PPPs.

Numerous factors have been identified as contributing to the success of capital projects in the literature (Chua et al., 1999). Identifying those key factors which may contribute to the profitable conclusion for the stakeholders if applied to the public projects is crucial (Morledge and Owen, 1998). The major objective of this study is to (i) identify the CSFs and quantify their influence on PPP success in Turkey, as a developing country, and (ii) explore the underlying dimensions of those CSFs. In this respect, an extensive literature review was conducted to compile CSFs of construction projects and then these factors were refined to obtain a set of 23 CSFs that relate to PPPs. Then, a questionnaire survey was designed and administered to construction professionals in Turkey. The collected data were analysed to observe the practices and perceptions of the industry in terms of PPP implementation. Factor analysis was employed to group the underlying factors that contribute to PPP success. The findings of this research are expected to guide both public and private sector in terms of investing in and operating successful PPP projects.

2. THE ROLE OF PPPS IN CONSTRUCTION

According to the World Bank data in developing countries, the contract value of the PPP projects including privatization has increased steadily in the 1990s, and in 1997 reached the highest level (107 billion US dollars). After falling to 48.7 billion US Dollars in 2002, the annual amount started to rise again and reached the record level in 2010 (186.4 billion US Dollars). In total 5783 PPP projects have been funded and the total cost of these projects has reached 2,026 billion U.S. Dollars in energy, transport, telecom, sewerage sectors. Covering the period between 1990-2013 in the European Union, total number of PPP projects realized has reached 1626 for an annual average of 67, while the aggregate value of the projects is 310.57 billion Euros for an annual average project size of 12.94 billion Euros in transport, environment, education, healthcare, general public services, and public order and safety sectors (EPEC, 2013).

In a recent study, Gurgun et al. (2014) summarized the PPP experience in various countries, highlighting the potential of PPP projects in Turkey, as a developing country. Public and private sector collaboration practices in Turkey date back to the Ottoman Empire era. Concessions related to public service have gained legal status in 1910 and PPP in its present form was first implemented on electric power generation in 1984. With the target of entering into the world's top ten largest economies in 2023 (the 100th anniversary of Turkish Republic), public investment for infrastructure plays an important role in Turkey. Private sector driven development model was adopted in the 1980s. As a result, public investments in industry decreased and infrastructure investments came to the fore in the central investment budget. The PPP models that are currently in use are concession; Build-Operate-Transfer (BOT); Build-Operate (BO); Build-Lease-Transfer (BLT); and Transfer of Operating Rights (TOR). When the contract value by year is examined, a notable increase was experienced after 2012. At the end of year 2013, PPP contract value reached 46.14 billion USD. In Turkey, when PPP projects in operation and under construction until today are considered together, the total value exceeds

87.5 billion USD for 167 projects in highway, airport, seaport, marina, customs facility, urban infrastructure, healthcare, and energy sectors (Ministry of Development, 2012).

Given this background on the CSFs of PPP projects, this paper aims at obtaining a refined set of factors that affect PPP success; calculating the impact of those factors on success; and finding out the underlying dimensions of PPP success.

3. CRITICAL SUCCESS FACTORS OF PPPS

Tang et al. (2010) reviewed the literature to reveal different types of studies on PPPs. In their paper, they classified the studies as empirical or non-empirical. The empirical studies focus on risks, relationships, and financing; whereas the non-empirical studies focus on financing, project success factors, risks, and concession period. This study deals with the CSFs of PPPs in developing countries. The majority of the literature deals with success factors for construction projects in general without a clear emphasis on project type. There has been less number of studies focusing only on PPPs. For example, Qiao et al. (2001) identified eight independent CSFs for BOT projects: appropriate project identification, stable political and economic situation, attractive package, acceptable toll/tariff levels, reasonable risk allocation; selection of suitable subcontractors, management control and technology transfer. Chan et al. (2010) reported six project success factors as; project team commitment, contractor's competencies; risk and liability assessment; clients' competencies and constraints imposed by end-users.

In addition to these studies, many other factors have been reported in the literature: social support (Frilet, 1997); commitment (Stonehouse et al., 1996); mutual benefit (Grant, 1996); procurement transparency and competitive procurement process (Kopp, 1997); good governance (Badshah, 1998); government support (Zhang et al., 1998); a stable macro-economic environment (Dailami and Klein, 1997); suitable legal and administrative framework (Finnerty, 1996); sound economic policy (European Investment Bank, 2000), including available financing market (Akintoye et al., 1998); strong and good private consortium (Birnie, 1999); feasibility study/cost-benefit analysis (Hambros, 1999); effective risk allocation (Grant, 1996); and innovative technical solutions (Zantke and Mangels, 1999).

Given this background on the CSFs of PPP projects, this paper aims at obtaining a refined set of factors that affect PPP success; calculating the impact of those factors on success; and finding out the underlying dimensions of PPP success.

4. RESEARCH METHODOLOGY

A questionnaire survey is adopted as the most appropriate method to investigate the CSFs of PPP projects in Turkey from the perspectives of both the public and private sector participants. The questionnaire has three parts: Part One deals with general information on the respondents; Part Two with CSFs of PPP; and Part Three with the projects undertaken by the respondents (if any). The target population is experts from the private sector, semi-government or government sectors consisting of owners, project managers, consultants, contractors, financiers, and operators in the construction industry. Participants for the survey are mainly enlisted from the Turkish Contractors Association. These firms are highly experienced and they are expected to undertake PPP projects, therefore this sample is considered to be suitable. The

questionnaire survey is administered online and a total of 82 completely filled questionnaires are returned out of 365 sent out, resulting in a response rate of 22%.

4.1 General information

Among the 82 participants of the survey are chairman/members of the board of the directors (6), general managers (6), project coordinators (9), project managers (3), managers (12), technical chiefs (9), engineer/architects (32) and others (5). The majority (55%) of the respondents work in large organizations (>200 employees). Only 32% of the organizations have been involved in at least one PPP project. This is a perception based survey and the responses of both companies experienced and inexperienced in PPP were taken into account. The respondents have an average of 10.96 years of industrial experience and the average age of the respondents is 34. The respondents have been involved in 22 PPP projects in total so far. Table 1 outlines the procurement types for the PPP projects. Most of the cases can be regarded as medium and large scale, based on their project construction costs and operation NPV; only three transportation projects can be regarded as mega project (>1 billion USD). Most of the projects have 1-2 years or less in planning, 1-3 years in construction, and 20-25 years of operation by private contractors.

Table 1: PPP project procurement arrangement by sector

Sector	Type				
	BOT	BLT	BO	TOR	Other
Hospital	2	2	1	0	0
Power & Energy	1	0	0	0	0
Highway	3	0	1	0	0
Airport	2	0	0	0	0
Industrial Plant & Urban Infrastructure	1	0	0	1	0
Railways	0	0	0	3	1
Other	1	0	0	0	3
Total (22 projects)	10	2	2	4	4

An extensive literature review was conducted to identify success factors for PPP projects. The review covered not only PPP projects but all types of construction projects. An initial list was prepared consisting of 73 factors. A pilot study was performed with a group of three experts, including two experienced civil engineers and one civil engineering professor. The experts were selected such that the group had both relevant professional and academic background. The aim of this study was to obtain a final list. In order to avoid having factors with similar meanings, the initially identified 73 factors were distilled into 23 factors through interviews with the experts. The final list as shown in Table 2 is a complete representation of factors without any overlaps.

Table 2: List of critical success factors

Variable	Sources
Solid Private Consortium (V1)	Baker et al. (1988), (2002), Zhang (2005)
Extensive, Reasonable Cost-Benefit Assessment (V2)	Lipovetsky et al. (1997)

Favourable /Sound Investment Environment (V3)	Li et al. (2005)
Attractive Financial Package (V4)	Lipovetsky et al. (1997), Zhang (2005)
Stable Political and Economic Situation (V5)	Pinto and Covin (1989), Zhang (2005)
Favourable Legal Framework (V6)	Kerzner (1998), Zhang (2005), Li et al. (2005)
Executive Commitment of Public/Private Sectors (V7)	Kerzner (1987), Li et al. (2005)
Good Communication and Relations Among Stakeholders (V8)	Pinto and Slevin (1987), Baker et al. (1988), Pinto and Prescott (1988)
Efficient/Competitive Procurement Process (V9)	Kerzner (1987), Ashley et al. (1987)
Rational and Practical Project Manager (V10)	Kerzner (1987), Pinto and Covin (1989)
Effective Client Consulting (V11)	Pinto and Slevin (1987), Pinto and Covin (1989)
Wide Client Acceptance (V12)	Pinto and Prescott (1988), Pinto and Covin (1989)
Contractor/Client Competency (V13)	Jefferies et al. (2002), Qiao et al. (2001)
Thorough Technical Feasibility (V14)	Pinto and Slevin (1987), Baker et al. (1988)
Motivated and Experienced Project Team (V15)	Ashley et al. (1987), Pinto and Covin (1989)
Detailed/Clear Project Identification (V16)	Clarke (1999), Pinto and Slevin (1987)
Meeting Design Goals (V17)	Ashley et al. (1987), Lipovetsky et al. (1997)
Proper and Systematic Schedule/Cost/Quality/Budget Control (V18)	Ashley et al. (1987), Baker et al. (1988), Kerzner (1998)
Regular Monitoring and Feedback (V19)	Pinto and Slevin (1987), Pinto and Covin (1989)
Broad/Reasonable Risk Analysis and Risk Sharing (V20)	Zhang (2005), Li et al. (2005)
Strong Public Entity (V21)	Li et al. (2005)
Clear, Comprehensive Project Executive Strategies (V22)	Wong and Maher (1997)
Simple Structure of Project Organization (V23)	Clarke (1999), Kerzner (1987), Clarke (1999)

4.2 Descriptive statistics

For the 23 CSFs, the respondents were asked to evaluate the importance based on a five-point Likert scale. Likert scale is the most widely used rating scale. It is used to help individuals express the extent to which they agree or disagree with a particular statement. In this scale, the scores have following meanings: 1 = "Not Significant", 2 = "Fairly Significant", 3 = "Significant", 4 = "Very Significant" and 5 = "Extremely Significant".

Various types of statistical analysis were undertaken on the collected data, including descriptive analysis, reliability tests using Cronbach's alpha, mean ranking, analysis of variance (ANOVA), and factor analysis using the SPSS. The research results propounded that the Cronbach's alpha value of 0.873, which is greater than 0.7 is sufficient according to the Nunnally's (1978) guideline. Table 3 shows descriptive statistics of the CSFs based on the 82 responses collected from the respondents.

Table 3: Descriptive statistics

Variable	Private Client		Public Client		Contractor		Total		F	Sig. (5%)
	Mean	Rank	Mean	Rank	Mean	Rank	Mean	Rank		
V6	4.52	1	4.75	1	4.13	8	4.33	1	2.047	0.136
V16	4.48	2	4.42	6	4.23	1	4.33	2	0.450	0.639
V2	4.30	6	4.58	3	4.21	2	4.29	3	0.258	0.773
V13	4.39	3	4.50	5	4.17	6	4.28	4	0.228	0.797
V14	4.39	4	4.75	2	4.06	10	4.26	5	0.565	0.571
V15	4.26	10	4.25	9	4.19	4	4.22	6	0.099	0.906
V4	4.30	7	3.92	15	4.13	7	4.15	7	2.428	0.095
V10	4.26	9	4.25	8	4.06	9	4.15	8	0.240	0.788
V3	3.87	16	4.33	7	4.17	5	4.11	9	0.314	0.732
V18	4.35	5	4.00	14	3.96	12	4.07	10	0.048	0.953
V5	4.00	12	4.50	4	3.94	13	4.04	11	0.525	0.593
V19	4.00	13	4.17	12	4.02	11	4.04	12	0.713	0.493
V1	3.52	20	4.17	11	4.19	3	4.00	13	1.608	0.207
V8	4.26	8	4.00	13	3.83	15	3.98	14	0.953	0.390
V17	4.09	11	3.92	16	3.91	14	3.96	15	0.062	0.940
V21	3.96	14	3.58	20	3.74	17	3.78	16	2.076	0.132
V22	3.70	18	3.75	19	3.77	16	3.74	17	0.065	0.937
V7	3.78	17	3.83	17	3.68	18	3.73	18	0.176	0.839
V20	3.57	19	4.25	10	3.64	19	3.71	19	0.244	0.784
V9	3.91	15	3.75	18	3.47	20	3.63	20	2.210	0.116
V11	3.43	21	3.50	21	3.34	21	3.39	21	0.613	0.544
V23	3.26	22	3.25	22	3.34	23	3.30	22	0.215	0.807
V12	3.04	23	3.08	23	2.94	22	2.99	23	0.499	0.609

5. RESULTS AND DISCUSSION

A comparison between the findings of this study with the findings from previous studies show that the CSFs vary depending on the country under investigation. Besides, the rankings of factors change based on the respondents.

In this study, "legal framework" has been ranked the most important factor. There is not a unified PPP law in Turkey, different line ministries attempted to introduce different legislations for the use of identical PPP models in their perspective sectors; therefore, eleven primary laws are in force to introduce five PPP models (Emek, 2015). The need for a better legal framework is mentioned in the Tenth Development Plan of the Turkish government. Another important factor is "detailed/clear project identification". In PPP projects, necessity of clear project identification is higher than in the traditional procurement system. In Turkey, changes in

project specifications are very common even after the bidding process due to the business practices. The third most important factor is “extensive, reasonable cost-benefit assessment”. Turkey is a developing country and political-economic environment is not stable and interest rates, which directly affects the cost of a project can fluctuate sharply too often. This situation creates an insecure investment environment, thus the risk increases for the investors. To handle the increased level of risks, potential investors try to protect themselves by extending the operating time.

According to analysis of variance (ANOVA) test, participants from the public and private sectors mostly have similar views on PPP critical success factors, there is no statistically significant difference in the opinions of the public and private sectors. But in the ranking of the factors, there is a great difference between the public and private sectors. For example, the private sector (client and contractor) takes detailed/clear project identification as being very important factor, ranking it in 1st and 2nd place while this factor is ranked in 6th position by the public sector.

Factor analysis is intended to explore and detect underlying relationships among the factors, and describe them in fewer, but more concise and comprehensive factors. The value of the test statistics for sphericity is large (Barlett test of sphericity = 1301.78) and the associated significance level is small ($p < .000$), suggesting that the population correlation matrix is not an identity matrix. Observation of the correlation matrix shows that all the variables have a significant correlation at the 5% level, suggesting that there is no need to eliminate any of the variables for the principal component analysis. The value of the KMO statistic is 0.710, which according to Kaiser is satisfactory for factor analysis (Norusis, 1992).

Principal component analysis was undertaken, which produced a five-factor solution with eigenvalues greater than 1.000, explaining 68.15% of the variance. The factor grouping based on varimax rotation is shown in Table 4. Each variable belongs to only one of the factors, with the loading on each factor exceeding 0.50. It is observed that “attractive financial package” does not belong to any of the components. The five factors can be interpreted as:

- Factor 1 represents Project Finance;
- Factor 2 represents Project Management;
- Factor 3 represents Operational Factors;
- Factor 4 represents Procurement; and
- Factor 5 represents Organizational Factors.

These factors are named based on the common features of the corresponding variables. The best possible naming has been done.

Table 4: Rotated component matrix

Common Factors	Variables	Components				
		1	2	3	4	5
Project Finance	Favourable/Sound Investment Environment	0.808				
	Broad/Reasonable Risk Analysis and Risk Sharing	0.765				

	Solid Private Consortium	0.634				
	Stable Political and Economic Situation	0.632				
	Extensive, Reasonable Cost-Benefit Assessment	0.599				
Project Management	Rational and Practical Project Manager		0.765			
	Favourable Legal Framework		0.765			
	Contractor/Client Competency		0.735			
	Executive Commitment of Public/Private Sectors		0.567			
	Regular Monitoring and Feedback		0.518			
Operational Factors	Detailed/Clear Project Identification			0.783		
	Motivated and Experienced Project Team			0.684		
	Thorough Technical Feasibility			0.664		
	Good Communication and Relations Among Stakeholders			0.644		
	Meeting Design Goals			0.575		
	Proper and Systematic Schedule/Cost/Quality/Budget Control			0.524		
Procurement	Wide Client Acceptance				0.882	
	Efficient/Competitive Procurement Process				0.714	
	Effective Client Consulting				0.681	
Organizational Factors	Clear, Comprehensive Project Executive Strategies					0.779
	Simple Structure of Project Organization					0.722
	Strong Public Entity					0.612

6. CONCLUSIONS

This paper presents the findings of a questionnaire survey to investigate the CSFs of PPP projects in developing countries. In this respect, data was collected from Turkish construction industry. ANOVA results showed that there is no statistically significant difference in the opinions of the public and private sectors. Factor analysis was used to identify the underlying factor groupings of 23 CSFs and these factors are labelled as follows: project finance, project management, operational factors, procurement, and organizational factors. The most critical three factors for the Turkish construction industry are found to be ‘favourable legal framework’, ‘detailed/clear project identification’ and ‘extensive, reasonable cost-benefit assessment’.

The analysis results suggest that the most critical factor for PPP project success is favourable legal framework. It is not an unexpected situation for the case of Turkey, since the legal framework is very diverse and there is not a uniform PPP law in Turkey. The need for a favourable legal framework is also mentioned in the development plans of the government. The second most critical factor in a successful project delivery is detailed/clear project identification. Especially during the tendering process, construction time and operating time must be examined meticulously. In Turkey, generally project specifications constantly change even after the bidding process because of the country's national culture and business practices. In the Turkish construction industry, the clients do not allow sufficient time for planning, and eventually they ask for a number of revisions in the projects in later stages. Extensive, reasonable cost-benefit assessment is the third most critical success factor for PPP projects in Turkish construction industry. Before starting a PPP project, both the public sector and private sector should properly assess the projects pros and cons, risks, costs and what the project will bring. Since most PPP projects are high-budgeted and complex projects, cost-benefit assessment is highly critical. Since Turkey is a developing country and political/economic environment is not stable, interest rates that directly affect the cost of a project can fluctuate sharply too often. This situation creates an insecure investment environment, thus the risk increases for the investors. To deal with that risk, the potential firms to get involved in a PPP project prefer to extend the operation phase and protect themselves.

Deriving lessons from the mistakes and past experiences, the government should encourage the PPP method in Turkey; it will allow the timely delivery of public projects with high quality. Analysis results pointed out that the Turkish government should figure out legal issues first to attract the private sector and financiers. Secondly, each party should allocate a reasonable time to planning process to define project aim, goal and specifications, and finally realize technical feasibility study properly.

The findings of this study reflect the experiences and opinions of the Turkish professionals. The findings might vary based on the specific conditions of the countries where PPP projects are undertaken. Turkey represents a case of a developing country. However, the results would be different in case of a developed country, where legal structure has already been established.

7. REFERENCES

- Akintoye, A., Taylor, C. and Fitzgerald, E., 1998, *Risk Analysis and Management of Private Finance Initiative Projects*, Engineering, Construction and Architectural Management, Vol. 5, No. 1, pp. 9–21.
- Amponsah, C. T., 2010, *Public-Private Partnerships: Critical Success Factors for Procurements of Capital Projects*, Ph.D. Thesis, Capella University.
- Ashley, D. B., Laurie, C. S. and Jaselskis, E. J., 1987, *Determinants of Construction Project Success*, Project Management Journal, Vol. 18, No. 2, pp. 69-79.
- Badshah, A., 1998, *Good Governance for Environmental Sustainability, Public Private Partnerships for the Urban Environment Programme (PPPUE)*, United Nations Development Program (UNDP), New York.
- Baker, B. N., Murphy, D. C. and Fisher, D., 1988, *Factors Affecting Project Success: Project Management Handbook (2nd ed.)*, John Wiley & Sons, New York, USA.
- Birnie, J., 1999, *Private Finance Initiative (PFI) – UK Construction Industry Response*, Journal of Construction Procurement, Vol. 5, No. 1, pp. 5-14.
- Chan, A. P. C., Lam, P. T. I., Chan, D. W. M., Cheung, M. E. and Ke, Y., 2010, *Critical Success Factors for PPPs in Infrastructure Developments: Chinese Perspective*, Journal of Construction Engineering and Management, pp. 484-494.
- Chua, D. K. H., Kog, Y. C. and Loh, P. K., 1999, *Critical Success Factors for Different Project Objectives*, Journal of Construction Engineering and Management, Vol. 125, No. 3, pp. 142-150.

- Clarke, A., 1999, *A Practical Use of Key Success Factors to Improve the Effectiveness of Project Management*, International Journal of Project Management, Vol. 17, No. 3, pp. 139–145.
- Dailami, M. and Klein, M., 1997, *Government Support to Private Infrastructure Projects in Emerging Markets*, World Bank Latin American and Caribbean Studies Viewpoints: Dealing with Public Risk in Private Infrastructure, (ed. Irwin, T.), pp. 21-42, World Bank, Washington, D.C., USA.
- Emek, U., 2015, *Turkish Experience with Public Private Partnerships in Infrastructure: Opportunities and Challenges*, Utilities Policy, Vol. 1, No. 10.
- European Investment Bank, 2000, *The European Investment Bank and Public Private Partnerships*, The Newsletter of the International Project Finance Association, Vol. 1, pp. 3-4.
- European PPP Expertise Centre (EPEC), 2013, *Market Update - First Half of 2013*, Luxembourg.
- Finnerty, J. D., 1996, *Project Financing: Asset-Based Financial Engineering*, John Wiley and Sons, New York.
- Frilet, M., 1997, *Some Universal Issues in BOT Projects for Public Infrastructure*, International Construction Law Review, Vol. 14, No. 4, pp. 499–512.
- Grant, T., 1996, *Keys to Successful Public Private Partnerships*, Canadian Business Review, Vol. 23, No. 3, pp. 8-27.
- Gurgun, A. P. and Touran, A., 2014, *Public-Private Partnership Experience in the International Arena: Case of Turkey*, Journal of Management in Engineering, Vol. 30, No. 6, 04014029.
- Hambros, S. G., 1999, *Public-Private Partnerships for Highways: Experience, Structure, Financing, Applicability and Comparative Assessment*, Hambros SG, Canada.
- Jefferies, M. C., Gameson, R. and Rowlinson, S., 2002, *Critical Success Factors of the BOOT Procurement System Reflections from the Stadium Australia Case Study*, Engineering Construction and Architectural Management, Vol. 9, No. 4, pp. 352-361.
- Kerzner, H., 1987, *In Search of Excellence in Project Management*, Journal of Systems Management, pp. 30-39.
- Kerzner, H., 1998, *In Search of Excellence in Project Management: Successful Practices in High Performance Organizations*, Van Nostrand Reinhold, New York, USA.
- Kopp, J. C., 1997, *Private Capital for Public Works: Designing the Next-Generation Franchise for Public Private Partnerships in Transportation Infrastructure*, M.S. Thesis, Department of Civil Engineering, Northwestern University.
- Li, B. and Akintoye, A., 2003, *An Overview of Public-Private Partnership, Public-Private Partnerships: Managing Risks and Opportunities*, Blackwell Science Ltd.
- Li, B., Akintoye, A., Edwards, P. J. and Hardcastle, C., 2005, *Critical Success Factors for PPP/PFI Projects in the UK Construction Industry*, Construction Management and Economics, Vol. 23, pp. 459-471.
- Lipovetsky, S., Tishler, A., Dvir, D. and Shenhar, A., 1997, *The Relative Importance of Project Success Dimensions*, R & D Management, Vol. 27, No. 2, pp. 97-106.
- Ministry of Development, 2012, *Advances in PPP in Turkey and in the World*, Republic of Turkey Ministry of Development Memorandum, Ankara, Turkey.
- Morledge, R. and Owen, K., 1998, *Critical Success Factors in PFI Projects*, Proceedings of 14th Annual ARCOM Conference, University of Reading, Association of Researchers in Construction Management, Vol. 2, pp. 565-574.
- Ng, S. T., Xie, J. Z., Cheung, Y. K. and Jefferies, M., 2007, *A Simulation Model for Optimizing the Concession Period of Public-Private Partnerships Schemes*, International Journal of Project Management, Vol. 25, No. 8, pp. 791–798.
- Norusis, M. J., 1992, *SPSS for Windows, Professional Statistics*, Release 5, SPSS Inc., Chicago.
- Nunnally, J. C., 1978, *Psychometric theory (2nd ed.)*, McGraw-Hill, New York.
- Pinto, J. K. and Slevin, D. P., 1987, *Critical Factors in Successful Project Implementation*, IEEE Transactions on Engineering Management, Vol. 34, No. 1, pp. 22-27.
- Pinto, J. K. and Covin, J. G., 1989, *Critical Factors in Project Implementation: A Comparison of Construction and R&D Projects*, Technovation, Vol. 9, pp. 49-62.
- Pinto, J. K. and Prescott, J. P., 1988, *Variation in Critical Success Factors Over the Stages in the Project Life Cycle*, Journal of Management, Vol. 14, No. 1, pp. 5-18.
- Qiao, L., Wang, S. Q., Tiong, R. L. K. and Chan, T. S., 2001, *Framework for Critical Success Factors of BOT Projects in China*, The Journal of Project Finance, Vol. 7, No. 1, pp. 53-61.
- Shen, L. Y. and Wu, Y. Z., 2005, *Risk Concession Model for Build/Operate/Transfer Contract Projects*, Journal of Construction Engineering and Management, Vol. 131, No. 2, pp. 211–220.
- Stonehouse, J. H., Hudson, A. R. and O’Keefe, M. J., 1996, *Private Public Partnerships: The Toronto Hospital Experience*, Canadian Business Review, Vol. 23, No. 2, pp. 17–20.
- Tang, L. Y., Shen, Q. and Cheng, E. W. L., 2010, *A review of studies on Public-Private Partnership projects in the construction industry*, International Journal of Project Management, Vol. 28, pp. 683–694.
- Wong, Y. Y. and Maher, T. E., 1997, *New Key Success Factors for China’s Growing Market*, Business Horizons, Vol. 40, No. 3, pp. 43-52.

- Zantke, G. and Mangels, B., 1999, *Public Sector Client-Private Sector Project: Transferring the State Construction Administration into Private Hand*, Engineering, Construction and Architectural Management, Vol. 6, No. 1, pp. 78-87.
- Zhang, W. R., Wang, S. Q., Tiong, R. L. K., Ting, S. K. and Ashley, D., 1998, *Risk Management of Shanghai's Privately Financed Yan'an Donglu Tunnels*, Engineering, Construction and Architectural Management, Vol. 5, No. 4, pp. 399-409.
- Zhang, X. Q. and Kumaraswamy, M. M., 2001, *Hong Kong Experience in Managing BOT Projects*, Journal of Construction Engineering and Management, Vol. 127, No. 2, pp. 154-162.
- Zhang, X. Q., 2005, *Critical Success Factors for Public Private Partnerships in Infrastructure Development*, Journal of Construction Engineering and Management, ASCE, Vol. 131, No. 1, pp. 3-14.

**ENERGY, BUILDING PERFORMANCE AND
ENVIRONMENTS**

HEALTH AND WELLBEING IN THE BUILT ENVIRONMENT AND ITS RELEVANCE IN GLOBAL SUSTAINABLE ASSESSMENT SYSTEM

Y. Al Horr¹, M. Arif², A. Kaushik², E. Elsarrag¹ and A. Mazroei³

¹*Gulf Organisation for Research and Development (GORD), Doha, Qatar*

²*School of Architecture and Built Environment, University of Wolverhampton, Wolverhampton, UK*

³*Qatari Diar Real Estate Development Company, Doha, Qatar*

Abstract: Sustainability standards state criteria to create adequate comfort, health and well-being conditions inside the new and existing buildings. The requirements for health and comfort are critical especially to employees who spend more than eight hours per day in their offices. International principles, standards are trying to identify the optimum and most comfortable existing conditions of the commercial buildings. The aim of the research is to link occupants and well-being with the Global Sustainability Assessment System (GSAS). The purpose is to check whether the GSAS rating system and its prerequisites provide a comprehensive analysis for the optimum design of the indoor environment and to identify any gaps to prepare a proposal on how to address them. The study compared indoor environment aspects and their health problems against all the categories and criteria of GSAS rating system. The GSAS rating system has sufficiently addressed the occupant health and wellbeing issues. The research study would be helpful to green building professionals who use GSAS rating system in building design. The research study also provides a good starting point for researchers working in the field of sustainable buildings and indoor environment research.

Keywords: Global Sustainability Assessment System, Indoor Environment Quality, Occupant Comfort, Occupant Well-Being

1. INTRODUCTION

The aim of the paper is to investigate GSAS rating system in order to outline its degree of focus towards Health and wellbeing of occupants.

Human health and well-being are of utmost importance when it comes to designing an indoor environment. The main purpose of built environment is to provide a comfortable habitat and protect occupants from harsh and uncontrollable conditions of nature. A building or habitat leading to any adverse impact on occupants' health and well-being defeats the sole purpose of the built environment. One of the biggest challenges of modern architecture is to create a healthy, beautiful and comfortable atmosphere inside buildings. The aim of every green building development is to achieve comfortability and well-being with the minimum energy cost. The occupant well-being is defined regarding health, comfort and happiness. These three aspects harmonise with the fundamental architecture pillars defined 2000 years ago by Vitruvius as "Firmness, Commodity, and Delight". There is a rise in concern about indoor environment quality in the workplace. Occupant comfort and health in a work environment have a direct impact on occupant productivity (Heerwagen, 2000). Indoor Environment Quality (IEQ) problems lead to unhealthy buildings and unhealthy occupants. However, the relationship between indoor environment quality and occupant health & wellbeing is a complex relationship. Sustainability standards state criteria to create adequate comfort, health and well-being conditions inside the new and existing buildings. The requirements for health and comfort are critical especially to employees who spend more than eight hours per day in their offices. International principles, standards, and previous studies are trying to conclude to the optimum and most comfortable existing conditions of the commercial buildings. Different indoor environment aspects like thermal, visual, acoustic conditions contribute to achieving the

occupant comfort, defining the overall relationship between indoor environment conditions and occupant health and wellbeing (Fisk, 2000, Fisk and Rosenfeld, 1997). The investigation led to a literature review on indoor environment quality and its aspects that have a significant effect on human health and well-being.

A comprehensive literature review resulted in the identification of the five IEQ aspects that influence occupant health, well-being, and productivity (Al horr et al., 2016):

1. Indoor air quality (Wolkoff, 2013)
2. Thermal comfort (Djongyang et al., 2010)
3. Acoustic comfort (Huang et al., 2012)
4. Visual comfort (Gou et al., 2014)
5. Sick Building Syndrome (Nedved and Abdul-Wahhabi, 2011)

Green building rating systems rate the buildings on various aspects that have an impact on the environment and its occupants. The rating systems such as LEED (Leadership in Energy and Environmental Design), BREAAAM (Building Research Establishment Environmental Assessment Method), GSAS (Global Sustainability Assessment System) acknowledge the significance of indoor environment quality's impact on health and wellbeing. The aim of this paper is to link occupant health and wellbeing aspects with the GSAS. Middle Eastern countries including Qatar have seen a rapid growth and development in past decade. There is significant development taking place in Qatar since it won the 2020 world cup. GSAS is widely used green building rating/assessment system in Qatar. In this context, this study is an opportunity to investigate efficiency of GSAS in the area of occupant health and wellbeing. The purpose is to check whether the GSAS rating system and its prerequisites provide a comprehensive analysis for the optimum design of the indoor environment and to identify any gaps in the current rating system and its features.

2. GLOBAL SUSTAINABLE ASSESSMENT SYSTEM AND OCCUPANTS' HEALTH & WELL-BEING

Global Sustainability Assessment System (GSAS) is an international sustainability rating system developed by Gulf Organization for Research and Development (GORD) through several years of intense research endeavours.

- GSAS was developed by drawing best practices adopted from 40 different rating systems known regionally and internationally.
- The primary objective of GSAS is to create a sustainable built environment that minimises ecological impact while addressing the specific social and cultural needs and environment of the region.
- GSAS is the Middle East's first integrated and performance-based sustainability assessment system for the built environment. The systematic evaluation method is applied seamlessly from the macro to a micro scales encompassing urban design, infrastructure and buildings levels.

GSAS rating system measures and evaluates every project on eight key aspects or categories that have a direct impact on environmental stress mitigation (Figure 1). Each Category is assigned a weight based on Analytical Hierarchy Process (AHP). The categories are then

broken down into specific criteria that measure and define these individual issues. A score is awarded to each criterion based on the level of compliance.

GSAS indicated that the impacts resulting from limited control and design of the indoor environment include are mainly the following:

- Climate Change
- Fossil Fuel Depletion
- Air Pollution
- Human Comfort & Health

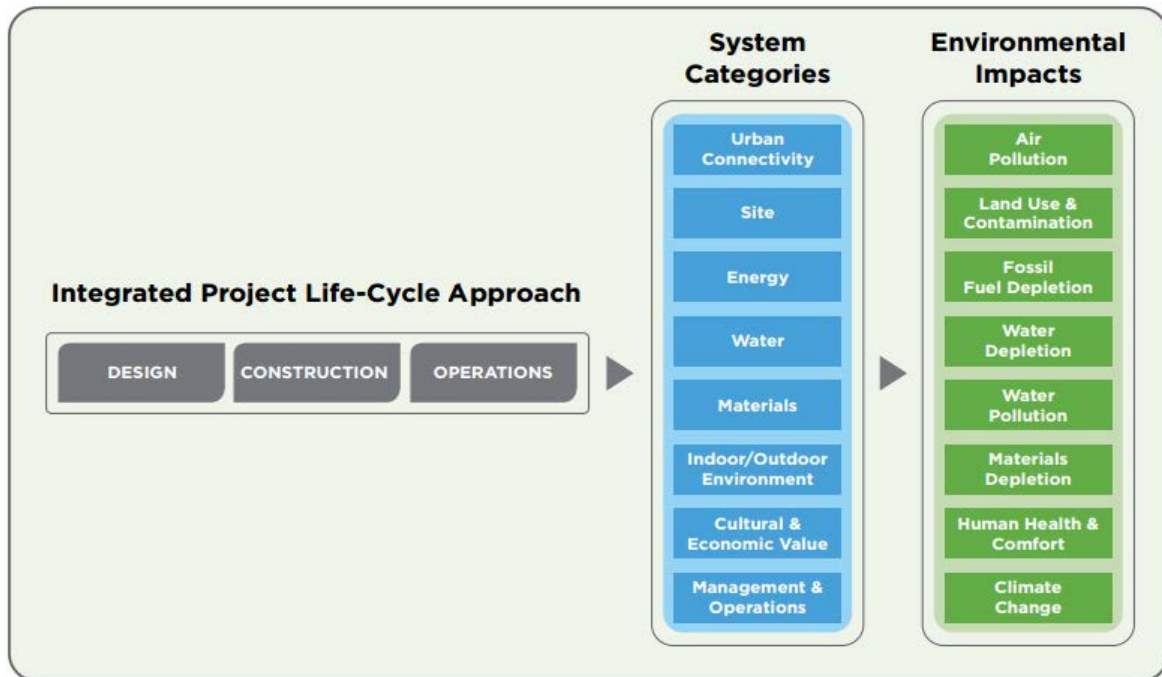

Figure 1: GSAS Categories and Environmental Impacts

The mitigation of the impact factors that could improve indoor environmental quality include:

- Monitoring air temperature and quality and adjusting or calibrating as appropriate.
- Maximise natural ventilation.
- Design an adequate mechanical ventilation system.
- Ensuring appropriate illuminance levels for visual performance and comfort.
- Maximise the use of natural lighting in interior spaces.
- Provide occupant comfort by minimising glare.
- Maximise external views for occupants.
- Reduce noise transfer from the building interior and exterior.
- Specify materials with low VOC levels.
- Control indoor pollutants and sources of airborne contamination.

The building's indoor environment category in GSAS is created mainly to control indoor comfort, health, and well-being. Indoor Environment [IE] consists of factors associated with indoor environmental quality such as thermal comfort and air, acoustic, and light quality.

It has a cumulative high weight in sustainability assessment rating of building in GSAS as shown in Figure 2.

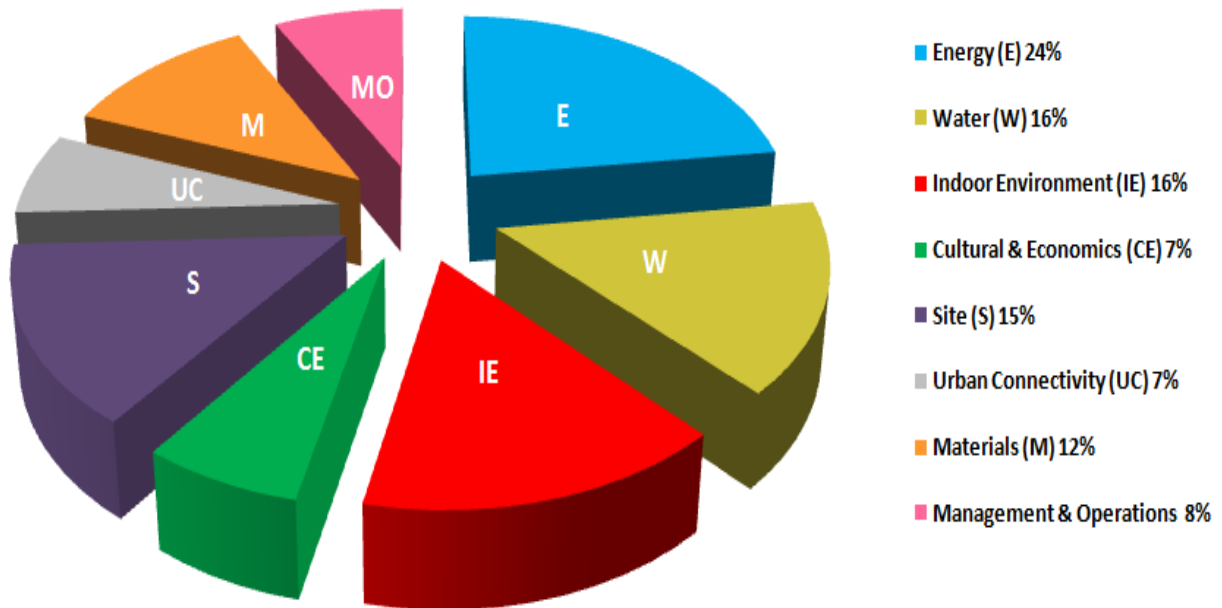

Figure 2: GSAS Categories and Weights V2.0

Based on all the above GSAS creates ten different criteria for indoor environmental comfort (Figure 3). The criteria can achieve a score from -1 (the worst performance) to 3 (excellent performance).

No	Criteria	Score		Weight								
		Min	Max	Commercial	Core + Shell	Single Residential	Group Residential	Education	Mosques	Hotels	Light Industry	
IE.1	Thermal Comfort	-1	3	1.57%	1.82%	N/A	N/A	1.37%	1.92%	1.65%	1.50%	
IE.2	Natural Ventilation	-1	3	1.13%	1.13%	3.00%	4.26%	1.83%	2.56%	2.21%	2.00%	
IE.3	Mechanical Ventilation	-1	3	2.33%	2.53%	N/A	N/A	1.83%	2.56%	2.21%	2.00%	
IE.4	Illumination Levels	-1	3	1.37%	1.87%	N/A	N/A	1.37%	1.92%	1.65%	1.50%	
IE.5	Daylight	-1	3	1.83%	1.87%	2.00%	4.26%	1.83%	2.56%	2.21%	2.00%	
IE.6	Glare Control	-1	3	1.37%	0.87%	N/A	N/A	1.37%	N/A	N/A	1.50%	
IE.7	Views	-1	3	1.37%	0.87%	N/A	N/A	1.37%	N/A	N/A	N/A	
IE.8	Acoustic Quality	-1	3	1.37%	1.38%	N/A	3.22%	1.37%	1.92%	1.65%	1.50%	
IE.9	Low-Emitting Materials	-1	3	1.83%	1.83%	3.00%	4.26%	1.83%	2.56%	2.21%	2.00%	
IE.10	Indoor Chemical & Pollutant Source Control	-1	3	1.83%	1.83%	N/A	N/A	1.83%	N/A	2.21%	2.00%	
Total Possible						16.00%	16.00%	8.00%	16.00%	16.00%	16.00%	16.00%

Figure 3: Criteria included in GSAS, Indoor Environment [IE] Category

The prior literature review concludes to the main aspects mentioned above that affect health and well-being of occupants, especially in the commercial buildings indoor environment (Al horr et al., 2016). These are related mainly to sick building syndrome, psychological impacts as well as occupants' behaviour and adaptation, indoor air quality, acoustic, visual and thermal

comfort, and materials. A special focus is also given to the correlation between sustainability aspects and building health and well-being to identify any conflict of their best practice. IE category in commercial buildings has three points for all the criteria. However, the criteria weightage tends to be more towards thermal comfort, mechanical ventilation, indoor pollutant source, and daylight criteria.

Sustainable techniques are mostly driven towards a better indoor and outdoor environment. However, it is not always the case. The aim is to connect the indoor comfort problems with the available strategies through a sustainability rating system. The paper aims to find out whether GSAS addresses all the investigated indoor comfort problems to avoid physical and physiological problems.

3. DISCUSSION

The paper analysed five indoor environment aspects, indoor environment problems related to them and their respective health and well-being consequences. The analysis also links the IEQ aspect and its implications with GSAS criteria and its scope.

3.1 Indoor air quality

The GSAS analysis focusing indoor air quality led to the identification of four indoor comfort problems and their respective consequences on occupants' health and wellbeing. The analysis also highlights any GSAS criteria linked with the indoor comfort problems under each IEQ aspect.

1. Volatile Organic Compounds (VOCs) & formaldehyde
High concentration of VOCs and chemical compound leads to headaches, dizziness, light – headedness, drowsiness, nausea, and eye and respiratory irritation (Jones, 1999). GSAS rating system has Indoor Environment (IE9) category. Its criterion nine focuses on the low-emitting material to address this problem. This criterion sets out to meet minimum emissions targets for indoor materials and finishes to ensure the comfort and health of occupants. The aim is to reduce the VOC and chemical compound concentration in the indoor environment.
2. Particulate Matter (PM)
Increased concentration of Particulate Matter in an indoor environment increases the risk of asthma, lungs infections and cardiac arrests (WHO, 2006). The sources of Particulate Matter (PM) are usually inside the buildings. GSAS rating sets out IE3: Mechanical Ventilation criterion to ensure an efficient mechanical ventilation to assure the air exchange to reduce any PM inside the building. GSAS Criterion IE10: Indoor Chemical & Pollutant Source Control focuses on indoor chemical and pollutant source control. This criterion helps to minimise potentially hazardous airborne contaminants that affect building occupants. Both criteria work together to address PM issue in an indoor environment.
3. Indoor Ozone
High level of ozone can be very harmful to occupants and lead to respiratory symptoms, asthma, lung function decrement, inflammation. High ozone exposure also increases the risk of early death (WHO, 2006). GSAS criteria IE2: Natural ventilation and IE3:

Mechanical Ventilation addresses the problems due to high-level exposure to ozone. These criteria help to introduce fresh air and reduce ozone in an indoor environment.

4. Indoor chemicals and pollutants

Various harmful elements present in paint, furniture are responsible for emitting indoor chemicals and pollutants that may result in increased respiratory problems, asthma and other lung infections (Wolkoff, 2013). GSAS criterion IE10: Indoor Chemical & Pollutant Source Control aims to minimise the use of material that results in airborne contaminants affecting building occupants' health.

3.2 Sick - Building Syndrome

Sick Building Syndrome is a group of health problem caused due to the bad indoor environment (Wargocki et al., 2000). The analysis led to the identification of four indoor environment problems that resulted in various health and wellbeing consequences.

1. Low fresh air and higher concentration of carbon monoxide and dioxide

A decrease in fresh air in an indoor environment can result in an increase in carbon monoxide and carbon dioxide concentration. It leads to irritation of eye, nose and throat, headache, and cough, wheezing, cognitive disturbances, depression like distress and other flu-like symptoms (Hudnell et al., 1992). The analysis identifies two criteria focusing the fresh air problem. GSAS criterion IE2: natural ventilation aims to encourage effective natural ventilation strategies to elevate the natural/fresh air in an indoor environment. Criterion IE3: Mechanical Ventilation outlines the recommended levels of effective mechanical ventilation to ensure occupant comfort and health.

2. Mould, dust in the air or furniture

Mould, dust particles and various allergens inside a building can lead to various allergic and irritant symptoms on pulmonary function, asthma and hypersensitivity pneumonitis and upper respiratory problems (Dharmage et al., 2002). GSAS criterion MO4: Water & Refrigerant Leak Detection Systems recommends minimising the impact of major water & refrigerant leakages by installing leak detection systems (detect mould). Criteria IE10: Indoor Chemical & Pollutant Source control helps to minimise potentially hazardous airborne contaminants affecting building occupants. Dust is a major issue in desert countries. This strategy is highly applicable in the Middle-eastern countries.

3. Chemical and Biologic contaminants

Any contaminants (chemical and biologic) present in indoor air leads to inflammatory sensation in occupants' eyes, nose, and throat (Jones, 1999). GSAS criterion IE10 focuses on minimising potentially hazardous airborne contaminants that are responsible for such health issues.

4. Fungal concentrations

Any fungal growth in any area inside a building can lead to allergic rhinitis that can cause nose blockage and inflammation inside the nose and lung infection/diseases leading to lower comfort level and satisfaction (Jaakkola et al., 2013). GSAS criterion IE10 outlines the strategies to minimise any potentially hazardous airborne contaminants that could lead to fungal growth and affecting building occupants.

3.3 Thermal comfort

Thermal comfort analysis indicates that majority of thermal comfort problems are due to the extreme variation in temperature, air moisture (dry & extreme humidity), and air velocity (Djongyang et al., 2010). There are two set of indoor environment problems related to thermal comfort.

1. Low dry bulb temperature, dry air, and high velocity
High temperature with high-velocity dry air may increase flu-like symptoms, rhinitis, nasal blockage and dry throat (Lan et al., 2010). GSAS criterion IE1: Thermal comfort outlines to provide a thermally comfortable environment to ensure the comfort and health of buildings occupants. GSAS criterion E1: Energy aims to improve building envelope and HVAC system efficiency for better thermal comfort for occupants.
2. High dry bulb temperature, high relative humidity, and moisture
An indoor environment with high temperature, high relative humidity and moisture may leave its occupants with lethargy, headache, asthma and breathing problems (Wolkoff and Kjærgaard, 2007). GSAS rating system criteria IE1: Thermal comfort and E1: Energy aims to create a comfortable thermal environment and improve building envelope and HVAC system to ensuring the longevity of better thermal comfort. GSAS system's criterion IE2: Natural Ventilation in conjunction with mechanical ventilation helps to deal with any extreme variations of humidity and temperature. Criterion S7: Heat Island Effect contributes to minimise heat island effect to reduce any impact on the surrounding habitat and environment and improve the indoor thermal comfort of the building. All these criteria collectively contribute to maintaining occupant favourable thermal conditions and avoid any health and well-being risk.

3.4 Acoustic comfort

The literature review on acoustic comfort highlighted four types of acoustic comfort problems and associated health risk and issues (Field, 2008). External sources and internal sources are two types of the noise source in a building.

1. Indoor Noise
Indoor noise can be caused due to any equipment (printers, lifts, elevators), unpleasant sounds from an adjacent office or desk (highly likely in an open plan office), and background and reverberation noise of a (HVAC system) building (Balazova et al., 2008).
2. Outdoor noise
Air/road traffic can cause outdoor noise, construction, public space (Pellerin and Candas, 2004). Research indicates that outdoor noise at work can lead to both short and long-term anxiety and other psychological problems (Stansfeld and Matheson, 2003, Landström et al., 1995, Sundstrom et al., 1994).

Both indoor and outdoor noise leads to distraction, headache, stress, annoyance, vexation and lack of privacy, productivity. GSAS criterion IE8: Acoustic quality recommends meeting minimum requirements for acoustic quality and standards within a building. Criterion S9: Noise pollution advises to minimise the noise produced by the project affecting nearby

buildings and environment. Both criteria help to create an acoustically comfortable indoor environment.

3.5 Visual comfort

Visual comfort is highly essential for humans. It has a high significance in a workplace environment. The literature directs towards the light, glare, and illuminance as primary factors of visual comfort. Both extremes of light intensity create visual discomfort (low light vs. glare problems) (Aries, 2005). Visual comfort is also influenced by nature and views of the outside environment. Shading is a crucial parameter in visual comfort. It is included in energy criterion, but a detailed study as a standalone criterion will enhance the visual comfort of the buildings. The analysis highlights three indoor comfort problems related to visual comfort.

1. Lack of natural lighting

Lack of natural light leads to eye disorder, (physical and psychological) discomfort, and lack of performance (L Edwards, 2000). GSAS criterion IE5: Daylight aims to optimise the exposure of natural daylight for interior spaces to improve light quality and reduce the need for artificial lighting. Criterion IE7: Views advises to provide occupants with access to external views to reduce the occupants' psychological discomfort. These criteria work collectively to improve the physical and psychological state of the building occupants.

2. Glare Phenomenon

Glare reduces the ability to see objects and highly affects the efficiency of the occupants. Prolonged exposure to direct glare can lead to various eye disorders (Hirning et al., 2013). GSAS criterion IE6: Glare control sets out recommendations to minimise direct and reflected glare within occupied spaces and improve visual comfort.

3. Lack of views and quality of views

Outside views and its quality highly influence the building occupants. Lack of view and or quality of outside view has a high-level impact on building occupants' physical and physiological discomfort, productivity, and sleep quality (Chang and Chen, 2005). It may also result in thermal and glare problems. GSAS criterion IE7: Views endorses to design buildings that provide occupants with access to external views. Criterion S4: Vegetation scopes to design landscaping around building to provide good quality of opinion to its occupants. These criteria are highly important, especially in office buildings.

4. Illumination levels and finishes' colour

The illumination levels of surfaces used in the indoor environment highly affect the visual comfort of the occupants (Han and Tai Kim, 2010). It may lead to distraction and reduce employees' performance. GSAS criterion IE: 4 Illumination levels set out to ensure light levels that are designed in line with best practices for visual performance and comfort. It requires design team to submit electrical drawings, illuminance level simulation results and lighting manufacturer's data sheet.

4. CONCLUSION

Human health and safety is the main purpose of any habitat development. The built environment sector has experienced a rise in concern to deliver projects that achieve

comfortability and well-being with minimum energy cost. Occupant well-being is defined as health, comfort and happiness. This research effort was motivated to understand indoor environment aspects that influence occupant health and well-being. A comprehensive literature review led to the identification of five aspects that affect occupant health and well-being. The motivation of this research paper was to analyse these aspects in current green building rating system. Global Sustainability Assessment System was investigated to link its category and criteria with indoor environment aspects that influence occupant health and wellbeing. The GSAS rating system has eight categories focusing different aspects of sustainability. It has an Indoor Environment (IE) targeting the indoor environment of the building. However, the study analysed all the categories and relevant criteria focusing any of the five indoor environment aspects.

Indoor Air Quality (IAQ) has a significant impact on occupant health and well-being. The research highlighted IAQ problems like VOCs, particulate matter, indoor ozone and various chemicals and pollutants. These problems lead to severe health and well-being consequences varying from asthma and lung infections to a headache, dizziness, and cardiac problems. GSAS rating system has addressed these problems by controlling the source of harmful emissions by using IE9 and IE10 that limits the use of low-emitting material and indoor chemical control respectively. The rating system also provides guidelines for a good ventilation system to increase the fresh air inside a building using mechanical ventilation IE3 and natural ventilation IE2 criteria for an indoor air quality. The analysis reflects that indoor air quality is well addressed using the above four criteria and submittals under the respective measure.

The second aspect identified was Sick Building Syndrome (SBS), it occurs due to severe indoor environment conditions caused by low fresh air leading to higher carbon gases, mould and dust particles, and airborne chemical, biological and fungal contaminants in the indoor environment. These problems result in health issues related to eyes, nose and throat. SBS also presents hazards of depression, hypersensitivity pneumonitis, and allergic rhinitis. GSAS approaches the problem of low fresh air and air contamination using criterion (MO4) water & refrigerant leak detection system and (IE10) chemical and pollutant source control. It addresses the fresh air problem by natural IE2 and mechanical IE3 ventilation criteria. The collective effort by above criteria helps to avoid any SBS related problems.

Thermal comfort is the most important indoor environment aspect for occupant health and wellbeing. Extreme variation in temperature, relative humidity, and air velocity leads to thermal discomfort. It may instigate flu-like symptoms, nasal blockage, dry throat, headache, asthma. GSAS rating system's criteria IE2 and E1 assist in maintaining a healthy thermal state by providing thermal comfort guidelines and building envelope, HVAC system instructions, respectively. Criterion S7 helps to avoid any heat island effect outside the building by landscape recommendation, and criterion IE2 complements the effort by advising natural ventilation to enhance indoor environment using the outdoor landscape.

Acoustic comfort is crucial for occupant satisfaction. Severe noise related problems may lead to a headache, stress, annoyance, and vexation. GSAS criterion IE8 provide guidelines for internal acoustic comfort and S9 recommend minimising noise pollution by any external sources of noise.

Visual comfort is essential for humans in any habitable environment. Visual discomfort problems like low lighting, lack of view, glare and illuminance phenomenon may lead to eyes disorders, distraction, and physiological discomforts. GSAS rating system's criteria IE5 and

IE7 assist in promoting the use of daylight and creating views for the occupants to help and create the visually pleasing indoor environment. Criterion S4 advises using landscaping around the building to enhance the view quality for the occupants. Criteria IE4 and IE6 contribute to control any glare and illumination problem in any occupied space. The study reveals a gap in the visual aspect. Shading is a crucial parameter in visual comfort. It is included in energy, but a detailed study as a standalone criterion will enhance the visual comfort of the building.

The research study has drawn links between GSAS rating system and indoor environment aspect affect human health and well-being. The study highlights the various criteria used to maintain a comfortable and pleasant indoor environment to foster human health and productivity. All the identified indoor environment aspects are well addressed in the GSAS rating system. The research study would be helpful to green building professionals who use GSAS rating system in building design. The research study also provides a solid starting point for researchers working in the field of sustainable buildings and indoor environment research. This research can be used as a template to investigate other green building rating systems such as BREEAM (Building Research Establishment Environmental Assessment Method), LEED (Leadership in Energy and Environmental Design) and green star. As a part of a bigger research endeavour, this research study would be used to develop an experiment focusing occupant health and wellbeing in an office environment.

5. ACKNOWLEDGEMENT

This research is supported by the Qatar National Research Foundation NPRP NO: 7-344-2-146.

6. REFERENCES

- AL HERR, Y., ARIF, M., KATAFYGIOTOU, M., MAZROEI, A., KAUSHIK, A. & ELSARRAG, E. 2016. Impact of indoor environmental quality on occupant well-being and comfort: A review of the literature. *International Journal of Sustainable Built Environment*, 5, 1-11.
- ARIES, M. B. C. 2005. *Human lighting demands: healthy lighting in an office environment*. Technische Universiteit Eindhoven.
- BALAZOVA, I., CLAUSEN, G., RINDEL, J. H., POULSEN, T. & WYON, D. P. 2008. Open-plan office environments: a laboratory experiment to examine the effect of office noise and temperature on human perception, comfort and office work performance. *Proceedings of indoor air*, 2008.
- CHANG, C.-Y. & CHEN, P.-K. 2005. Human response to window views and indoor plants in the workplace. *HortScience*, 40, 1354-1359.
- DHARMAGE, S., BAILEY, M., RAVEN, J., ABEYAWICKRAMA, K., CAO, D., GUEST, D., ROLLAND, J., FORBES, A., THIEN, F., ABRAMSON, M. & WALTERS, E. H. 2002. Mouldy houses influence symptoms of asthma among atopic individuals. *Clinical & Experimental Allergy*, 32, 714-720.
- DJONGYANG, N., TCHINDA, R. & NJOMO, D. 2010. Thermal comfort: A review paper. *Renewable and Sustainable Energy Reviews*, 14, 2626-2640.
- FIELD, C. 2008. Acoustic design in green buildings. *Ashrae Journal*, 50, 60-70.
- FISK, W. J. 2000. Health and productivity gains from better indoor environments and their relationship with building energy efficiency. *Annual Review of Energy and the Environment*, 25, 537-566.
- FISK, W. J. & ROSENFELD, A. H. 1997. Estimates of improved productivity and health from better indoor environments. *Indoor air*, 7, 158-172.
- GOU, Z., LAU, S. S.-Y. & YE, H. 2014. Visual alliesthesia: The gap between comfortable and stimulating illuminance settings. *Building and Environment*, 82, 42-49.
- HAN, H. & TAI KIM, J. 2010. Application of high-density daylight for indoor illumination. *Energy*, 35, 2654-2666.

- HEERWAGEN, J. 2000. Green Buildings, organizational success and occupant productivity. *Building Research & Information*, 28, 353-367.
- HIRNING, M. B., ISOARDI, G. L., COYNE, S., GARCIA HANSEN, V. R. & COWLING, I. 2013. Post occupancy evaluations relating to discomfort glare: A study of green buildings in Brisbane. *Building and Environment*, 59, 349-357.
- HUANG, L., ZHU, Y., OUYANG, Q. & CAO, B. 2012. A study on the effects of thermal, luminous, and acoustic environments on indoor environmental comfort in offices. *Building and Environment*, 49, 304-309.
- HUDNELL, H. K., OTTO, D. A., HOUSE, D. E. & MØLHAVE, L. 1992. Exposure of Humans to a Volatile Organic Mixture. II. Sensory. *Archives of Environmental Health: An International Journal*, 47, 31-38.
- JAAKKOLA, M. S., QUANSAH, R., HUGG, T. T., HEIKKINEN, S. A. M. & JAAKKOLA, J. J. K. 2013. Association of indoor dampness and molds with rhinitis risk: A systematic review and meta-analysis. *Journal of Allergy and Clinical Immunology*, 132, 1099-1110.e18.
- JONES, A. P. 1999. Indoor air quality and health. *Atmospheric Environment*, 33, 4535-4564.
- L EDWARDS, P. T. 2000. A literature review of the effects of natural light on building occupants.
- LAN, L., LIAN, Z. & PAN, L. 2010. The effects of air temperature on office workers' well-being, workload and productivity-evaluated with subjective ratings. *Appl Ergon*, 42, 29-36.
- LANDSTRÖM, U., ÅKERLUND, E., KJELLBERG, A. & TESARZ, M. 1995. Exposure levels, tonal components, and noise annoyance in working environments. *Environment International*, 21, 265-275.
- NEDVED, M. & ABDUL-WAHHABI, S. A. 2011. *Building Sick Syndrome in Public Buildings and Workplaces*.
- PELLERIN, N. & CANDAS, V. 2004. Effects of steady-state noise and temperature conditions on environmental perception and acceptability. *Indoor air*, 14, 129-136.
- STANSFELD, S. A. & MATHESON, M. P. 2003. Noise pollution: non-auditory effects on health. *British medical bulletin*, 68, 243-257.
- SUNDSTROM, E., TOWN, J. P., RICE, R. W., OSBORN, D. P. & BRILL, M. 1994. Office noise, satisfaction, and performance. *Environment and Behavior*, 26, 195-222.
- WARGOCKI, P., WYON, D. P., SUNDELL, J., CLAUSEN, G. & FANGER, P. 2000. The effects of outdoor air supply rate in an office on perceived air quality, sick building syndrome (SBS) symptoms and productivity. *Indoor air*, 10, 222-236.
- WHO 2006. *Air quality guidelines: global update 2005: particulate matter, ozone, nitrogen dioxide, and sulfur dioxide*, World Health Organization.
- WOLKOFF, P. 2013. Indoor air pollutants in office environments: assessment of comfort, health, and performance. *Int J Hyg Environ Health*, 216, 371-94.
- WOLKOFF, P. & KJÆRGAARD, S. K. 2007. The dichotomy of relative humidity on indoor air quality. *Environment International*, 33, 850-857.

APPLICATION OF ARTIFICIAL NEURAL NETWORK ANALYSIS IN DEFINING THE RELATIONSHIP BETWEEN INDOOR ENVIRONMENT QUALITY AND OCCUPANT PRODUCTIVITY

Y. Al Horr¹, M. Arif², A. Kaushik², P. Tumula³, E. Elsarrag¹ and A. Mazroei⁴

¹*Gulf Organisation for Research and Development (GORD), Doha, Qatar*

²*School of Architecture and Built Environment, University of Wolverhampton, Wolverhampton, UK*

³*School of Built Environment, University of Salford, Manchester, UK*

⁴*Qatari Diar Real Estate Development Company, Doha, Qatar*

Email: a.k.kaushik@wlv.ac.uk

Abstract: Humans spend most of their time indoors and the majority of the world's population lives in urban areas and spend most of their time in an office environment. There is a vast literature on indoor environment quality and its effects on occupant productivity. The main purpose of this paper is to highlight the development and application of Artificial Neural Network (ANN) model to define the relationship between indoor environment quality factors and occupant productivity. ANN represents a computational technique based on complex brain computation. It is highly applicable to non-linear functions and complex patterns. ANN has been applied in various disciplines like finance, biology, and bioinformatics to solve a wide range of complex non-linear problems. This model is developed to identify non-linear relationships between six indoor environment quality factors and occupant productivity in an office building in Qatar. The physical environment data was collected using 90 sensors, and occupant productivity was reported using online survey. This paper contributes to the research area of building performance and environment and data analytics in built environment research. It provides new data analysis method to establish a mathematical relationship between indoor environment and occupant productivity. It highlights a new dimension in data analytics in the built environment research.

Keywords: Artificial Neural Network, Data Analysis, Indoor Environment Quality, Occupant Productivity.

1. INTRODUCTION

Indoor environment quality has direct and indirect effects on occupants' health and productivity (Al Horr et al., 2016, Lan et al., 2010, Hescong, 1979). Humans spend most of their time indoors, and the majority of the urban population spend their time in an office environment (ASHRAE, 2005). Research indicates that indoor environment quality of an office environment has an impact on organisation's expenses (Heerwagen, 2000, Oseland, 1999). Employee salaries exceed the building operation cost by the factor of up to 25 (Clements-Croome, 2006). A small change in occupant performance can lead to major fluctuation in company's operation cost. A nationwide study in the UK indicates that good indoor environment quality can lead to an increase in productivity by up to 20%, equivalent to £135 bn per year (Clements-Croome, 2015, Wheeler and Almeida, 2006). Various green building guidelines focus on indoor environment quality and include thermal comfort, acoustic and air quality criteria in health and wellbeing category (US Green Building Council, 2004, Miller et al., 2009, BRE, 2007). There is a need to develop criteria and submittals that focus directly on occupant productivity in an office building. Current criteria in LEED (Leadership in Energy Environmental Design) and BREEAM (Building Research Establishment Environmental Assessment Method) mainly focus on the mechanical aspects of indoor environment quality assessment (Lee and Guerin, 2010, Fisk, 2000). The majority of these criteria such as visual

comfort, thermal comfort, indoor air quality, acoustic comfort contribute to occupant productivity. However, there is no direct and explicit effort to focus and address occupant productivity. Research also indicates that it is not necessary that optimum thermal comfort and optimum productivity exist in the same range (Fisk, 2000). The research team identified this opportunity to investigate and analyse indoor environment quality and its effect on occupant productivity in an indoor environment. The research was limited to physical environment factors and physical comfort of occupants.

Literature review helped to identify four measurable physical factors that affect occupant satisfaction and productivity (Al Horr et al., 2016):

1. Indoor Air Quality and Ventilation (Ng et al., 2012, Zhang et al., 2011, Wolkoff and Kjærgaard, 2007)
2. Thermal Comfort (Fanger, 1970, de Dear et al., 1997, Tanabe et al., 2007, Djongyang et al., 2010)
3. Lighting and Daylighting (Hopkinson et al., 1966, Alrubaih et al., 2013, L Edwards, 2000)
4. Noise and Acoustics (Sundstrom et al., 1994, Banbury and Berry, 2005, Mui and Wong, 2006)

The research team analysed these four indoor environment quality factors and data collection and analysis methods to develop research experiment design.

2. RESEARCH EXPERIMENT DESIGN

The aim of the research study is to develop a model that seeks to define a statistical relationship between different Indoor Environment Quality (IEQ) factors and occupant productivity. The research study proposed to measure indoor environmental quality factors and capture occupant response to those indoor environment quality factors. The research project experiment is divided into two progressive steps. The first part is data collection and the second is data analysis. The experiment is being performed at the Gulf Organisation for Research and Development (GORD) office in Doha, Qatar. The research design is explained in figure – 1. The employee data and indoor environment data is being collected using online survey and sensors. The data will be analysed using the artificial neural network analysis. The outcome of analysis would be some a polynomial equation representing mathematical models that define the relationship between indoor environment quality factors and occupant productivity. The models would be tested and validated using sensitivity analysis. The updated models would be used to define robust relationship equations between the indoor environment quality factors and occupancy productivity. These equations will be used to develop new benchmarks for indoor environment quality in office buildings.

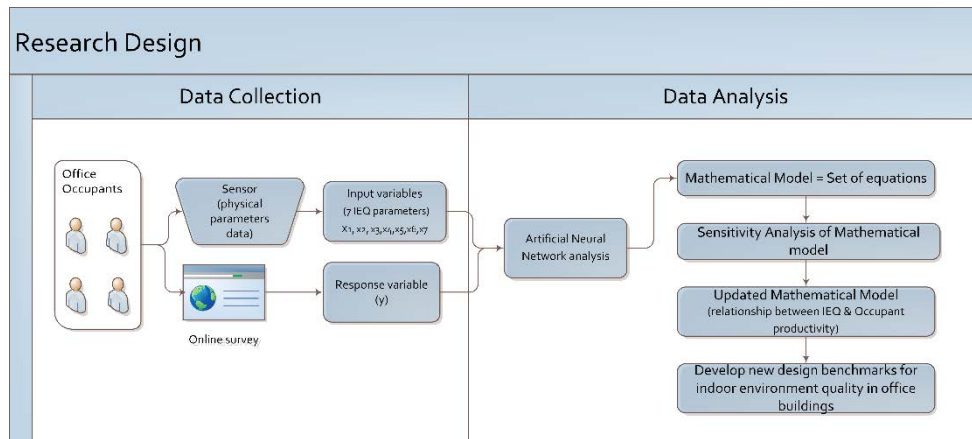

Figure 19: Research Design

2.1 Data collection

The literature review highlighted Post Occupant Evaluation (POE) to measure and collect data related to indoor environment quality and occupant productivity (Ozturk et al., 2012). Earlier, data collection in the field of the indoor environment was conducted using bulky apparatus. However, advancement in information technology has led to innovative sensors that can collect data on various indoor parameters wirelessly and transmit the data to online databases. The research team started data collection using various wireless sensors that sense different indoor environment quality parameters and send the data to a base monitoring unit. The Base monitoring unit (figure - 2) uploads the data to an online database that stores and monitors functionality of all the sensors. The data is available to monitor and download from an online dashboard (figure -3).



Figure 2: T3521 - Base BRE unit

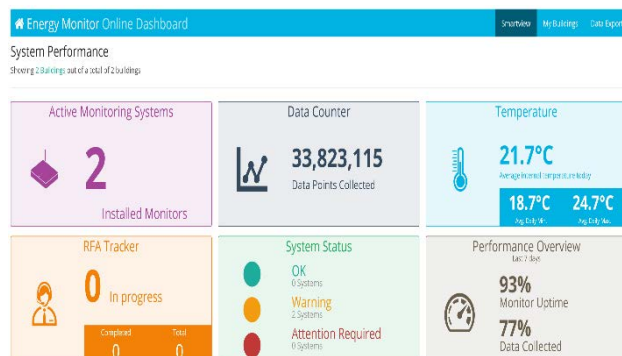

Figure 3: Online Dashboard

The research team also developed a subjective assessment equipment to collect occupant response and feedback to the indoor environment. The research team analysed various survey used in the industry for collecting data from occupants.

The list of survey analysed are:

- 1) BUS (Building Use Studies Occupant Survey) (Dykes and Baird, 2013)
- 2) CWRE (Checklist of Work Related Experiences) (Stokols and Scharf, 1990)
- 3) AMAWorkWare (Alexi Marmot Associates) ((AMA), 2004)

- 4) DQI (Design Quality Indicator) (Prasad, 2004)
- 5) BASE (Building Assessment Survey and Evaluation) (Levermore et al., 1999)
- 6) ASHRAE RP-884 (de Dear and Brager, 1998)
- 7) CBE Survey (Centre for the Built Environment) (Zagreus et al., 2004)
- 8) OPN (Office Productivity Network) (Oseland, 2004)

A survey focusing the needs of this study was developed after analysing above surveys. It is divided into two parts. The first part collects information about the employees. It includes 13 questions collecting information about employee’s age, gender, education, workspace and lifestyle habits to outline an employee profile. Second part collects information on the influence of indoor environment factors on their productivity. It enlists four questions that collect employee opinion on effects of various indoor environment quality factors on their productivity. The survey response is set as per five-point Likert scale (Hinkin, 1998). The survey is sent via email to GORD employees fortnightly.

Q14. How have indoor environment quality factors affected your productivity?

Table 12: IEQ factors and productivity

	Indoor environment factor	Very Negatively	Negatively	Neutral	Positively	Very Positively
a	Thermal comfort					
b	Natural ventilation					
b	Mechanical ventilation					
d	Illumination levels					
e	Daylight					
f	Glare control					
g	Views					
h	Acoustic quality					
i	Low-emitting materials					
j	Indoor chemical & pollutant source control					
k	Office layout					
l	Closeness to nature					

The indoor environment quality factors and their parameters along with survey questions are discussed below:

2.1.1 Indoor air quality

The literature review identifies two main physical parameters in the IAQ study. These are ventilation rate, indoor pollutant levels (Panagiotaras et al., 2013, Persily and Emmerich, 2012). The occupant survey includes questions to understand occupants’ perceptions towards the existing indoor air quality. It lists parameters such as low –emitting materials, indoor chemical & pollutant control, natural ventilation and mechanical ventilation (Table- 1).

The survey also collects employee responses on discomfort from humidity, air movement, drafts, and indoor dust.

Q17. Do you feel any discomfort in the office from any of the below?

- a. High Humidity
- b. Low humidity
- c. High air movement
- d. Low air movement
- e. Glare
- f. Heat from office equipment
- g. Drafts from vents
- h. Temperature difference inside office area
- i. Thermostat inaccessible
- j. Thermostat controlled by someone else
- k. Indoor surface dust

A measurement analysis of IAQ parameters along with results from the occupant survey would help to draw an understanding of the preferable range of indoor air quality (Table – 2).

Table 13: Indoor Air Quality Parameters & Data Collection Instrument

Indoor Air Quality		
Measurable Parameters	Instrument	Occupant Survey
Ventilation rate	Building Management System	Occupants' perception of the indoor air quality
Indoor pollutant level	(T3571, T3571) Sensor (CO2 & Volatile Organic Compound)	

The researchers are using T3571 sensor (Figure - 4) to measure carbon dioxide and T3576 sensor (Figure - 5) to measure indoor pollutant like Volatile Organic Compounds (VOC). Ventilation rate would be monitored using the Building Management System.



Figure 4: T3571 - Carbon Dioxide Sensor



Figure 5: T3576 - VOC & Decibel Sensor

2.1.2 Thermal comfort

Literature review recommends two physical parameters; temperature and relative humidity (Djongyang et al., 2010). Occupant survey includes a question (Question 14) to understand occupants' response to the office's thermal environment (Table-1). Also, question 16 and 17 collects employee responses on the thermal sensation and any discomfort caused due to HVAC (Heating Ventilation and Air-Conditioning) system of the office. The information collected from the survey and sensors would provide data for a comparison analysis based on occupants' thermal preferences (Table – 3). Outside temperature and humidity also influence occupants' thermal comfort and perception (Humphreys and Nicol, 2000). Analysis of physical measurements and the survey results would help to understand the thermal comfort of the occupants.

Q16. How would you describe your thermal sensation in the last two weeks (in the office)?

- a) Hot
- b) Warm
- c) Slightly warm
- d) Neutral
- e) Slightly cool
- f) Cool
- g) Cold

Table 3: Thermal Comfort Parameters & Data Collection Instrument

Thermal Comfort		
Measurable Parameters	Instrument	Occupant Survey
Room Temperature	Sensor (T3524C)	Occupant Response <ul style="list-style-type: none"> • Too cold • Cold • Satisfactory/neutral • Hot • Too hot
Room Relative Humidity		
Outside Temperature	Vantage Pro2	
Outside Humidity		

The researchers are using the T-3524C sensor (Figure - 7) to measure room temperature and relative humidity.



Figure 6: T – 3524 - Temperature & Relative Humidity Sensor



Figure 7: Vantage Pro2- Outside temp. & RH sensor

2.1.3 Lighting and daylighting

Literature review indicates that luminance levels contribute to maintaining healthy indoor lighting levels (Sivaji et al., 2013). The luminance levels are being measured by T3551 sensors (Figure - 8).

Table 4: Lighting Parameters & Data Collection Instrument

Lighting and Daylighting		
Measurable Parameters	Instrument	Occupant Survey
Luminance level (ambient and desk)	Lux Sensor (T3551)	Occupants' response to indoor lighting



Figure 8: T3551 - Lux Sensor

Alongside the data collection from sensors, occupants' response on current indoor lighting will be collected using the online survey (Table-1). Lighting and Daylighting parameters such as daylight, glare control and illumination levels are listed in question 14. Analysis of both these methods would enable the determination of the occupants' preferred lighting setting in an indoor environment (Table-4).

2.1.4 Noise and acoustics

The literature review suggests that sound (decibel) levels affect occupant productivity (Banbury and Berry, 2005). The researchers aim to monitor decibel level in the office by using T - 3576 sensor (Figure-5) and the occupant survey to draw an understanding of occupants' responses to the existing sound levels (Table-1). Employee response to question 14 would help to develop occupant perception of the acoustic environment. Analysis of the recorded and recommended sound levels along with the occupants' responses would help to determine the comfort range of the noise factor for office occupants (Table-5).

Table 5: Noise Parameter & Data Collection Instrument

Noise and Acoustics		
Measurable parameters	Instrument	Occupant Survey
Indoor sound level	Decibel sensor	Occupants' response to noise level in the office

2.2 Data analysis

The experiment follows Artificial Neural Network methodology for data analysis. It provides a framework for analysing the IEQ parameter data and occupant survey data to develop various statistical relationship models that outline the degree of influence of each IEQ factor on occupant productivity. ANN analysis would produce set of equations that represent the relationship between the indoor environment quality parameters and occupant productivity. It would be followed by performing sensitivity analysis to develop occupant response profile.

2.2.1 Artificial Neural Network

Artificial Neural Network (ANN) represents a computational technique that is based on complex brain computation. It inspires from brain's ability of adaptive learning while going through a process and identifying patterns and relationships (Haykin and Network, 2004). It is highly applicable to non-linear functions and complex patterns. ANN identifies the relationships between input and output by analysing the recorded data (Caudill and Butler, 1994). ANN has been applied in various disciplines like finance, biology, and bioinformatics to solve a wide range of complex non-linear problems (Hagan et al., 1996). Neural networks can be developed, adjusted and trained to achieve a specific target or solution. ANN can also be used to define patterns and relationships between different input and output factors (Bishop, 1995). The use of single and multi-layer networks can enable to achieve statistical equations that represent the relationship between the input value and output values (Beale et al., 1992). In this study, research team used a commonly used self-learning neural network. It is called feed-forward Multi-Layer Perceptron (MLP) (Jain et al., 1996, Hu et al., 1991). The team has developed four layers ANN model. First layer is input layer, used to input the data of nine parameters collected by sensors. Second and third layer are the hidden layers. Fourth layer is the output layer consisting of occupant response and performance data from the organisation (Figure-9). The connections used to connect each layer are called weights.

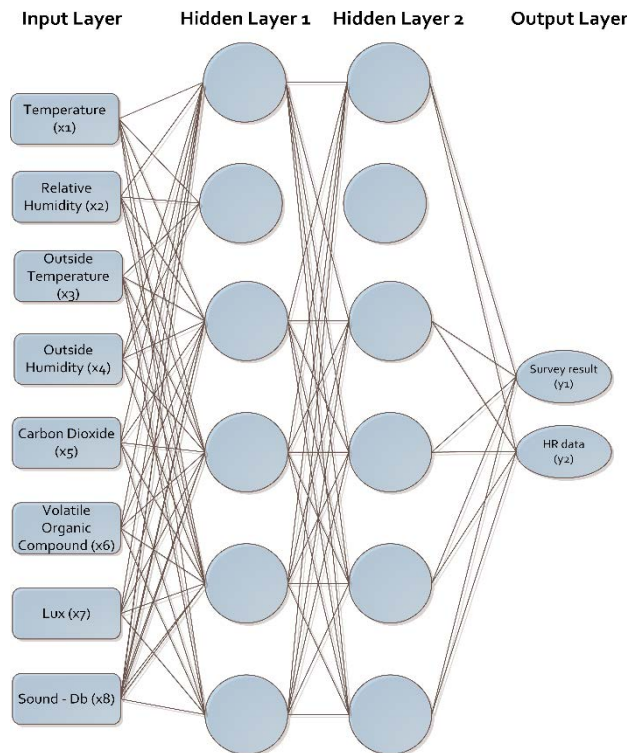

Figure 9: ANN Model for Research Analysis

The ANN research analysis would create an artificial computational neural network model in MATLAB to test the input data and its relation to output data (survey data and occupant productivity data from HR system). ANN would involve running numerous tests to train the model. Multiple runs would enable to train and develop the model to outline the relationship equations between the inputs (IEQ parameters) and output (productivity of employees). The relationship equations and models would help to define the impact of each IEQ factors and its individual parameters on occupant productivity.

Table 6: ANN Input and Output Variables

IEQ factor	Parameter	Measured by	Input Variable	Response/ performance variable
Thermal comfort	Temperature	Sensor	X_1	y (calculated from company's HR system & survey responses)
	Relative humidity	Sensor	X_2	
	Outside Temperature	Sensor	X_3	
	Outside humidity	Sensor	X_4	
Indoor Air Quality	Carbon dioxide	Sensor	X_5	
	Volatile Organic Compound (VOC)	Sensor	X_6	
Lighting	Lux level	Sensor	x_7	
Noise	Sound level	Sensor	x_8	

The participating organisation (GORD) has two offices in Qatar Science and Technology Park (QSTP). There are 35 employees participating for six months (Two surveys a month).

$$A \times B \times C = 35 \times 6 \times 2 = 420$$

A = Number of employees

B = Number of months

C = Survey/month

The experiment will have a maximum of 420 data points. If we consider 20% loss due to employee holidays and data loss, then experiment provides roughly 340 data points. The data points should be enough for the required analysis. The survey responses would be time stamped. They can be correlated with the sensor data for each data point. These data points would enable to train the developed neural network and calculate and generate several relationship equations between eight input variables (x) and the performance variable(y) (Table-6).

The set of equations will be used to develop a response profile for each of the eight variables using sensitivity analysis.

2.2.2 Sensitivity analysis

Sensitivity analysis is defined as a study of how uncertainty in the output of a model can be attributed to different sources of uncertainty in the input to the model (Saltelli et al., 2008). Sensitivity analysis can be classified into mathematical, statistical and graphical methods (Saltelli et al., 2000). This research study is going to use a nominal range sensitivity method for threshold and local sensitivity analysis. It maps the effect on response/output of the equation by individually varying only one input variable across its entire range of plausible values while holding all other inputs at their mean or base-case value (Cullen and Frey, 1999, Christopher Frey and Patil, 2002). The difference in the output due to the change in the input variable is referred to as the sensitivity or swing weight of the equation or model for that particular input variable (Morgan et al., 1992). The sensitivity analysis is also used to validate a linear relation statistical model by comparing the model performance in nominal and extrapolated inputs (Saltelli et al., 2008). Researchers can represent the sensitivity as a positive or negative percentage change compared to the base, mean and nominal input.

This research study would apply sensitivity analysis to each of the eight parameters while keeping other seven parameters unchanged to identify the range and response profile of the occupant productivity towards that particular IEQ parameter. The analysis will be done using five different values of each variable, ranging from lowest recorded value by the sensor to the maximum recorded value by the sensor during data collection (Table – 7).

Table 7: IEQ Parameter and sensitivity run table

IEQ factor	Parameter	Measured by	Input Variable	Sensitivity runs
Thermal comfort	Temperature	Sensor	X_1	5
	Relative humidity	Sensor	X_2	5
	Outside Temperature	Sensor	X_3	5
	Outside humidity	Sensor	X_4	5
Indoor Air Quality	Carbon dioxide	Sensor	X_5	5
	Volatile Organic Compound (VOC)	Sensor	X_6	5
Lighting	Lux level	Sensor	x_7	5
Noise	Sound level	Sensor	x_8	5

The output of the sensitivity analyses would be an occupant productivity response profile for each of the IEQ parameters. This profile can be used to define the changes in occupant productivity on that particular parameter and thus help to identify the range of maximum productivity for that particular parameter.

All eight ranges of IEQ parameters for maximum productivity would be used to develop guidelines and recommendations for both design and operations of the office environment to yield maximum occupant productivity.

3. CONCLUSION

This research paper presented a new research design that defines a mathematical relationship between numerous IEQ parameters and occupant productivity. It provides a comprehensive explanation of research steps and process. It also outlines the data collection methods and instruments used in the research study. ANN modelling is widely used data analysis method in scientific community to resolve complex non-linear relationship and prediction problems. It is an emerging data analysis method in the area of built environment research. ANN method is highly efficient in identifying and predicting nonlinear relationship in variable data sets. This study presented a complex problem of establishing relationship between eight IEQ parameters and occupant productivity. The data IEQ data was collected from 90 sensors and occupant response was collected using survey. Data collected is high in volume and diverse in nature. ANN modelling is highly efficient in solving such problems with huge datasets. It will produce set of equations that would represent relationships between individual IEQ factors and occupant productivity. Sensitivity analysis will be used to validate these relationship equations. These equations would help to developed design and operation recommendations for built environment professionals in Qatar. This paper explains ANN and sensitivity analysis, their applications and serves as an example for other researchers to use ANN and sensitivity analysis in built environment research to tackle complex non-linear data analysis situations in a research study. This research paper contributes to existing knowledge of metrics and methodologies that assess indoor environment quality and occupant productivity in an office building. Research design and process presented in the paper can be used to develop and conduct experiment to create relationship model for office buildings in any climate zone. The research study is ongoing, and data cleaning and initial analysis have begun. The research team would publish series of articles to disseminate the results and findings of the study. It would contribute to the existing knowledge of occupant productivity and indoor environment quality. It would provide a direction for future research and development of green building rating system across the globe.

4. ACKNOWLEDGEMENT

This research is supported by Qatar National Research Foundation NPRP NO: 7-344-2-146.

5. REFERENCES

- (AMA), A. M. A. 2004. AMA Workware Toolkit: Case Study Department of Health Office Evaluation.
- Al Horr, Y., Arif, M., Kaushik, A., Mazroei, A., Katafygiotou, M. & Elsarrag, E. 2016. Occupant productivity and office indoor environment quality: A review of the literature. *Building and Environment*, 105, 369-389.

- Alrubaih, M. S., Zain, M. F. M., Alghoul, M. A., Ibrahim, N. L. N., Shameri, M. A. & Elayeb, O. 2013. Research and development on aspects of daylighting fundamentals. *Renewable and Sustainable Energy Reviews*, 21, 494-505.
- ASHRAE 2005. ASHRAE handbook of fundamentals. *American Society of Heating, Refrigerating and Air Conditioning Engineers*. Atlanta, Georgia, USA: ASHRAE.
- Banbury, S. & Berry, D. 2005. Office noise and employee concentration: Identifying causes of disruption and potential improvements. *Ergonomics*, 48, 25-37.
- Beale, M., Hagan, M. T. & Demuth, H. B. 1992. Neural network toolbox. *Neural Network Toolbox, The Math Works*, 5, 25.
- Bishop, C. M. 1995. *Neural networks for pattern recognition*, Oxford university press.
- BRE. 2007. *bre-how does breeam work* [Online]. Available: www.breeam.org [Accessed].
- Caudill, M. & Butler, C. 1994. *Understanding neural networks: computer explorations: a workbook in two volumes with software for the macintosh and pc compatibles*, Mit Press.
- Christopher Frey, H. & Patil, S. R. 2002. Identification and review of sensitivity analysis methods. *Risk analysis*, 22, 553-578.
- Clements-Croome, D. 2006. *Creating the productive workplace*, Taylor & Francis.
- Clements-Croome, D. 2015. Creative and productive workplaces: a review. *Intelligent Buildings International*, 1-20.
- Cullen, A. C. & Frey, H. C. 1999. *Probabilistic techniques in exposure assessment: a handbook for dealing with variability and uncertainty in models and inputs*, Springer Science & Business Media.
- De Dear, R., Brager, G. & Cooper, D. 1997. *Developing an Adaptive Model of Thermal Comfort and Preference*.
- De Dear, R. & Brager, G. S. 1998. Developing an adaptive model of thermal comfort and preference.
- Djongyang, N., Tchinda, R. & Njomo, D. 2010. Thermal comfort: A review paper. *Renewable and Sustainable Energy Reviews*, 14, 2626-2640.
- Dykes, C. & Baird, G. 2013. A review of questionnaire-based methods used for assessing and benchmarking indoor environmental quality. *Intelligent Buildings International*, 5, 135-149.
- Fanger, P. O. 1970. *Thermal Comfort*.
- Fisk, W. J. 2000. Health and productivity gains from better indoor environments and their relationship with building energy efficiency. *Annual Review of Energy and the Environment*, 25, 537-566.
- Hagan, M. T., Demuth, H. B., Beale, M. H. & De Jesús, O. 1996. *Neural network design*, PWS publishing company Boston.
- Haykin, S. & Network, N. 2004. A comprehensive foundation. *Neural Networks*, 2, 41.
- Heerwagen, J. 2000. Green Buildings, organizational success and occupant productivity. *Building Research & Information*, 28, 353-367.
- Heschong, L. 1979. *Thermal Delight in Architecture*.
- Hinkin, T. R. 1998. A brief tutorial on the development of measures for use in survey questionnaires. *Organizational research methods*, 1, 104-121.
- Hopkinson, R. G., Petherbridge, P. & Longmore, J. 1966. *Daylighting*, Heinemann.
- Hu, Y. H., Xue, Q. & Tompkins, W. J. Structural simplification of a feed-forward, multilayer perceptron artificial neural network. [Proceedings] ICASSP 91: 1991 International Conference on Acoustics, Speech, and Signal Processing, 14-17 Apr 1991 1991. 1061-1064 vol.2.
- Humphreys, M. A. & Nicol, J. F. 2000. Outdoor temperature and indoor thermal comfort: Raising the precision of the relationship for the 1998 ASHRAE database of field studies/Discussion. *Ashrae Transactions*, 106, 485.
- Jain, A. K., Mao, J. & Mohiuddin, K. M. 1996. Artificial neural networks: A tutorial. *Computer*, 29, 31-44.
- L Edwards, P. T. 2000. A literature review of the effects of natural light on building occupants.
- Lan, L., Lian, Z. & Pan, L. 2010. The effects of air temperature on office workers' well-being, workload and productivity-evaluated with subjective ratings. *Appl Ergon*, 42, 29-36.
- Lee, Y. S. & Guerin, D. A. 2010. Indoor environmental quality differences between office types in LEED-certified buildings in the US. *Building and Environment*, 45, 1104-1112.
- Levermore, G. J., Lowe, D. J. & Ure, J. W. 1999. Occupant feedback questionnaire producing a fingerprint and a score. *ASHRAE Transactions*, 105, 661.
- Miller, N. G., Pogue, D., Gough, Q. D. & Davis, S. M. 2009. Green Building and Productivity. *Journal of Sustainable Real Estate*, 1, 65.
- Morgan, M. G., Henrion, M. & Small, M. 1992. *Uncertainty: a guide to dealing with uncertainty in quantitative risk and policy analysis*, Cambridge University Press.
- Mui, K. & Wong, L. 2006. A method of assessing the acceptability of noise levels in air-conditioned offices. *Building Services Engineering Research and Technology*, 27, 249-254.
- Ng, L. C., Musser, A., Persily, A. K. & Emmerich, S. J. 2012. Indoor air quality analyses of commercial reference buildings. *Building and Environment*, 58, 179-187.

- Oseland, N. 1999. *Environmental Factors Affecting Office Worker Performance: A Review of Evidence*, London, CIBSE.
- Oseland, N. 2004. Occupant feedback tools of the office productivity network. *Assessed* <http://www.officeproductivity.co.uk>.
- Ozturk, Z., Arayici, Y. & Coates, S. 2012. Post occupancy evaluation (POE) in residential buildings utilizing BIM and sensing devices: Salford energy house example.
- Panagiotaras, D., Nikolopoulos, D., Koulougliotis, D., Petraki, E., Zisos, I., Yiannopoulos, A., Bakalis, A. & Zisos, A. 2013. Indoor Air Quality Assessment: Review on the topic of VOCs.
- Persily, A. K. & Emmerich, S. J. 2012. Indoor air quality in sustainable, energy efficient buildings. *HVAC&R Research*, 18, 4-20.
- Prasad, S. 2004. Clarifying intentions: the design quality indicator. *Building Research & Information*, 32, 548-551.
- Saltelli, A., Ratto, M., Andres, T., Campolongo, F., Cariboni, J., Gatelli, D., Saisana, M. & Tarantola, S. 2008. Introduction to Sensitivity Analysis. *Global Sensitivity Analysis. The Primer*. John Wiley & Sons, Ltd.
- Saltelli, A., Tarantola, S. & Campolongo, F. 2000. Sensitivity analysis as an ingredient of modeling. *Statistical Science*, 377-395.
- Sivaji, A., Shopian, S., Nor, Z. M., Chuan, N.-K. & Bahri, S. 2013. Lighting does Matter: Preliminary Assessment on Office Workers. *Procedia - Social and Behavioral Sciences*, 97, 638-647.
- Stokols, D. & Scharf, T. 1990. Developing standardized tools for assessing employees' ratings of facility performance. *ASTM special technical publication*, 55-79.
- Sundstrom, E., Town, J. P., Rice, R. W., Osborn, D. P. & Brill, M. 1994. Office noise, satisfaction, and performance. *Environment and Behavior*, 26, 195-222.
- Tanabe, S.-I., Nishihara, N. & Haneda, M. 2007. Indoor Temperature, Productivity, and Fatigue in Office Tasks. *HVAC&R Research*, 13, 623-633.
- US Green Building Council 2004. Making the business case for high performance green buildings. *US Green Building Council, Washington, DC*.
- Wheeler, G. & Almeida, A. 2006. These Four Walls: The Real British Office. *Creating the Productive Workplace*, 357.
- Wolkoff, P. & Kjærgaard, S. K. 2007. The dichotomy of relative humidity on indoor air quality. *Environment International*, 33, 850-857.
- Zagreus, L., Huizenga, C., Arens, E. & Lehrer, D. 2004. Listening to the occupants: a Web-based indoor environmental quality survey. *Indoor Air*, 14, 65-74.
- Zhang, H., Arens, E. & Pasut, W. 2011. Air temperature thresholds for indoor comfort and perceived air quality. *Building Research & Information*, 39, 134-144.

EVALUATION OF THE NEW DESIGN SUMMER YEAR WEATHER DATA USING PARAMETRICAL BUILDINGS

Y. Ji¹, I. Korolija² and Y. Zhang³

¹*School of the Built Environment, University of Salford,*

²*UCL Energy Institute, University College London, London UK*

³*Energy Simulation Solutions Ltd, UK*

Email: y.ji@salford.ac.uk

Abstract: The Chartered Institution of Building Services Engineers (CIBSE) updated the near extreme weather (Design Summer Year – DSY) for all 14 locations in the UK in 2016. This new release attempts to address the underlying shortcomings of the previous definition where the averaged dry bulb temperature was the sole metric to choose DSY among source weather years. The aim of this research is to evaluate whether the new definition of the probabilistic DSYs can consistently represent near extreme condition. London historical weather data and their correspondent DSYs were used in this research. Dynamic thermal modelling using EnergyPlus was carried out on large number single zone offices (parametric study) which represent a large portion of cellular offices in the UK. The predicted indoor warmth from the sample building models show that these new definitions are not always able to represent near extreme conditions. Using multiple years as DSY is able to capture different types of summer warmth but how to use one or all of these DSYs to make informed judgement on overheating is rather challenging. The recommended practice from this research is to use more warm years for the evaluation of overheating and choose the near extreme weather from the predicted indoor warmth.

Keywords: Design Summer Year, EnergyPlus, Overheating, Parametric study, Weather data

1. INTRODUCTION

In assessing potential overheating in free running buildings, near-extreme weather data were often used. The Chartered Institution of Building Services Engineers (CIBSE) released standard weather data for three sites (London, Manchester & Edinburgh) since early 2000 (CIBSE Guide J 2002). Later release included 14 cities (16 sites) in total using the same selection criteria – the third warmest year (**near extreme**) among a 20 year source weather datasets, or the mid-year of the upper quartile if more than 20 years (Levermore & Parkinson 2006). The warmth of a weather year was judged by the average Dry Bulb Temperature from April to September. The appropriateness of this averaged Dry Bulb Temperature method was criticised on the fact that at some locations in the UK the predicted indoor warmth using DSY is cooler than its corresponding Test Reference Year (TRY) which represents a typical weather (averaged condition) among the same source weather years (CIBSE TM48 2009; Nicol et al 2009; Smith & Hanby 2012). A detailed analysis on this averaged Dry Bulb Temperature method discovered a number of issues which could cause the chosen DSY less likely being representative as a near-extreme weather (Jentsch et al 2014). The latest release of CIBSE weather data in early 2016 (Virk & Eames 2016) was following the updated method discussed in TM49 – Design Summer Years for London (CIBSE TM49 2014). TM49 uses a definition called “weighted cooling degree hours (WCDH)” to judge the outdoor warmth. And as a result three complete weather years were selected from a much larger source weather datasets (1950 to 2006). The three complete weather years are intended to represent: inner urban (1976 – a year *with a long period of persistent warmth*), rural (2003 – a year *with a more intense single warm spell*) and intermediate urban & sub-urban (1989 – a *moderately warm summer*). WCDH is based on adaptive comfort temperature (CIBSE Guide A 2006; BS EN 15251 2007), and it is closely

related to the likelihood of thermal discomfort (Smith & Hanby 2012). However, this Dry Bulb Temperature only selection method and the ‘conceptual free running building’ analogy used in TM49 can be problematic in practices as argued in recent research (Jentsch et al 2015; Ji et al 2016): other weather parameters such as solar radiation and wind should also be included in selecting DSY; also, assuming operative temperature is the same as outdoor temperature for the ‘conceptual building’ could be unrealistic.

In light of the above, this research aims to evaluate whether the new release of near extreme weather data from CIBSE are fit for purpose. The purpose for developing (or selecting) weather data sets is to analyse building's performance, how various buildings designs respond to weather data is clearly a question in need of answering. For any particular building design in question, it is expected that a warm year should have higher likelihood of causing overheating (in case of free running buildings) or have higher cooling demand (in case of air conditioned buildings). What have been lacking from previous researches are - the use of large number of building models to verify near extreme weather data against their baseline historical weather data; and the appropriate methods for investigating individual weather parameter's contribution on indoor warmth prediction. In this paper a large number of single zone office models were used to examine how these models respond to the near extreme weather conditions.

2. METHODOLOGY

2.1 Historical weather data

London historical weather data from 1976 to 1995 were used in this work. Among these 20 years, the year 1976 and 1989 are the two out of three pDSYs proposed in the CIBSE latest release (CIBSE TM49 2014). The key weather parameters within these source weather years include: global solar irradiation, diffuse solar irradiation, cloud cover, dry-bulb temperature, wet-bulb temperature, atmospheric pressure and wind speed. For free running buildings, dry-bulb temperature (DBT), global solar irradiation (GSR) and wind speed (WS) are thought to have direct influence on indoor operative temperature. Hereinafter, they will be referred as DBT, GSR and WS.

For the purpose of generating standard near extreme weather data, various analyses have been used in ranking the warmth of the historical weather data. Some ranking methods were using on DBT only (CIBSE Guide J 2002; Smith & Hanby 2012; CIBSE TM49 2014), others considered parameters such as GSR and WS in addition to DBT (Jentsch et al 2015; Ji et al 2016). Table 1 shows various warmth rankings for the 20 years historical weather data used in this research where individual column indicates from coolest to warmest (top to bottom). In the table, **HO** stands ‘number of hours over’ a base temperature. **ADH** stands ‘accumulated degree hours’ over a base temperature, it is the sum of the ‘degree hours (d·h)’ over that base temperature. For example, using 21°C as a base temperature, a temperature at 21.2°C has 0.2d·h; a temperature at 28.3°C gives 7.3d·h. ADH is the sum of all these degree hours. It is a metric to indicate the severity of warmth. **AvgDBT** here stands the averaged dry bulb temperature metric used in CIBSE Guide J (2002), **WCDH** is the weighted cooling degree hour metric used in CIBSE TM49 (2014), and t'_{sa} is the sol-air temperature proposed in Ji et al (2016) which takes in to account, DBT, GSR & WS. It is evident in Table 1 that the warmth ranking position for an individual year does vary. The year 1976 was consistently warmer than other years, however, when the base temperatures are less than 17°C, the **HO** metric shows the year 1989 takes the warmest positions.

Table 1: Ranking orders of London 1976 to 1995 weather data with various metrics (TRY is added as a reference)

>15 °C		>17 °C		>19 °C		>21 °C		>23 °C		>25 °C		>27 °C		>28 °C		>29 °C		AvgDBT	WCDH	t'_{sa}
HO	ADH	HO	ADH	HO	ADH	HO	ADH	HO	ADH	HO	ADH	HO	ADH	HO	ADH	HO	ADH			
L77	L77	L77	L77	L77	L88	L77	L88	L88	L78	L78	L78	L78	L78	L93	L93	L93	L93	L77	L78	L77
L86	L88	L88	L88	L88	L77	L88	L78	L78	L88	L80	L80	L88	L77	L78	L78	L88	L88	L86	L88	L78
L78	L78	L86	L78	L85	L78	L85	L77	L77	L80	L88	L88	L93	L93	L77	L77	L81	L81	L78	L93	L80
L88	L85	L78	L85	L78	L85	L78	L80	L80	L77	L85	L85	L79	L88	L80	L80	L80	L80	L79	L77	L79
L85	L86	L85	L80	L80	L80	L80	L85	L85	L85	L77	L77	L85	L80	L88	L81	L78	L78	L88	L85	L86
L87	L80	L81	L86	L86	L79	L86	L79	L79	L79	L79	L79	L80	L81	L91	L88	L77	L77	L85	L91	L88
L79	L79	L79	L79	L79	L86	L79	L93	L93	L93	L93	L93	L77	L85	L85	L85	L92	L92	L80	L81	L85
L81	L81	L80	L93	L81	L93	L87	L86	L86	L81	L81	L81	L81	L91	L81	L91	L91	L87	L81	L80	L81
L80	L87	L87	L81	L87	L87	L93	L87	L87	L87	L87	L91	L91	L79	L82	L82	L87	L82	L87	L79	L87
L93	L93	L93	L87	L93	L81	L81	L81	L81	L91	L91	L87	L82	L82	L79	L87	L85	L91	L91	L87	TRY
L91	TRY	TRY	TRY	TRY	TRY	TRY	L91	L82	L86	L86	L82	L92	L92	L92	L92	L82	L85	L93	L82	L93
TRY	L91	L91	L91	L82	L82	L82	L82	L91	L82	L82	L92	L87	L87	L87	L79	L79	L79	TRY	L92	L91
L84	L82	L84	L82	L91	L91	L91	L92	L92	L92	L92	L86	L86	L86	TRY	TRY	L86	L86	L84	L86	L94
L94	L84	L94	L92	L84	L92	L92	TRY	TRY	TRY	TRY	TRY	TRY	TRY	L86	L86	TRY	TRY	L94	TRY	L84
L83	L92	L82	L84	L94	L84	L94	L84	L84	L84	L84	L84	L84	L84	L84	L84	L84	L84	L82	L84	L83
L90	L94	L92	L94	L92	L94	L84	L94	L94	L94	L94	L94	L94	L94	L94	L94	L94	L94	L83	L94	L82
L82	L83	L83	L83	L83	L83	L90	L83	L90	L83	L90	L89	L90	L89	L89	L89	L89	L89	L92	L83	L92
L95	L90	L90	L90	L90	L90	L83	L90	L83	L90	L83	L83	L89	L83	L83	L83	L83	L83	L90	L89	L90
L92	L95	L95	L89	L95	L89	L95	L89	L89	L89	L89	L90	L83	L90	L90	L90	L90	L95	L89	L90	L95
L76	L89	L76	L95	L89	L95	L89	L95	L95	L95	L95	L95	L95	L95	L95	L95	L95	L90	L95	L95	L89
L89	L76	L89	L76	L76	L76	L76	L76	L76	L76	L76	L76	L76	L76	L76	L76	L76	L76	L76	L76	L76

2.2 Building parametric models

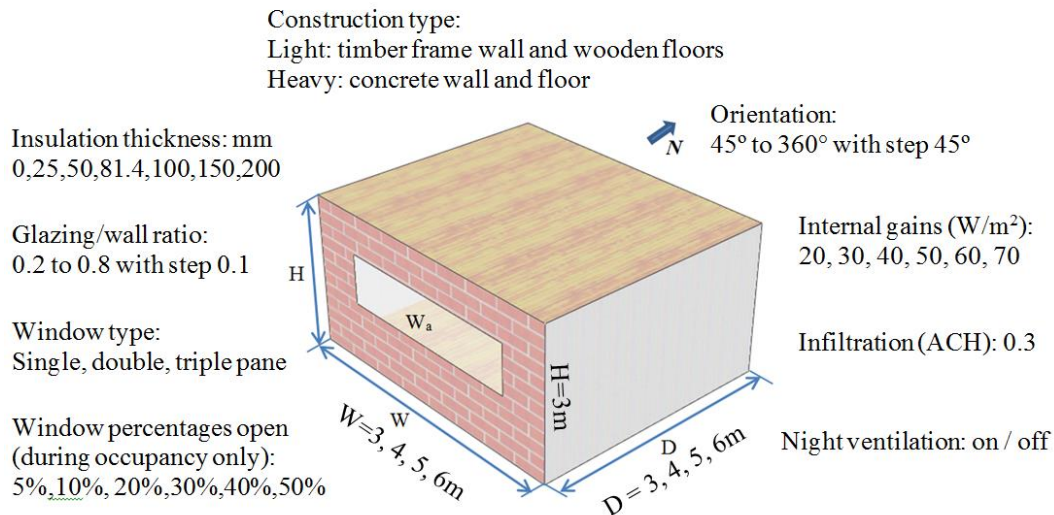

Figure 1: The single zone office model and their varying parameters

Various single zone offices are represented by a single zone dynamic thermal model with a fixed height of 3 metres, and varying widths and depth between 3 and 6 metres, respectively, to represent a wide range of cellular and open-plan office spaces. Deriving from the four towns survey, such side lit spaces may account for over 45% of all offices (Steadman et al 2000a). Figure 1 is the graphic representation of the single zone model. This single zone space is assumed to be taken from a free running office building. Only the façade with a window is

exposed to the ambient environment. The rest are either internal roof/ceiling or partition walls. Adiabatic condition is assumed for these internal surfaces. The cellular office is occupied from 9am to 5pm during which ventilation is provided by opening the window. A fixed night time ventilation schedule may be enabled, so that ventilation is employed when internal temperature is above 22°C between 1am and 8am. The model is created using EnergyPlus. In order to cover the wide variations of office spaces in the UK, parameters including orientation, wall construction, insulation level, window type, window sizes and openable area, internal heat gain, and night ventilation operation are applied to the model. The number of all variations resulted from the combinations of different parameter values are in the order of 10⁶. Modelling the full population of building models is unrealistic therefore sampling is needed.

2.3 Building models sampling conditions

Four building models sampling scenarios are considered. **Sample "i"** examines the combined influence of temperature, solar radiation and wind using complete random building models. **Sample "ii"** is also using the complete random building models but focuses on the sole influence of temperature, excluding the impact of solar radiation and wind completely. For solar, a spectrum filter applied as a shading device that stops all solar irradiance on the facade is employed. This setting prohibits visible light through the window for the whole simulation period. For wind, the weather data is filtered to remove wind speed, so that natural ventilation is only driven by buoyancy. **Sample "iii"** examines the maximum possible impact of solar radiation. The random building models are filtered by the ‘maximum window to wall ratio’ and the ‘south east window’ (315°) where it receives the most solar gains during occupancy period compared with other orientations. Influence of wind is also disabled using the same method as in Sample "ii". **Sample "iv"** assesses the maximum possible wind influence without the presence of solar radiation. By examining London's weather data, the prevailing wind direction is south west. Therefore the random building models have the following fixed conditions: south west facing (45°), maximum window to wall ratio (80%) and maximum openable area (50%), whereas solar is blocked using the shading device. Table 2 is a summary of the sampling conditions.

Table 2: Considered sampling scenarios

Sample index	Descriptions
i	Full parametric building models (complete random sample)
ii	Full parametric building models but the influence of wind and solar is removed
iii	Influence of wind is removed; random models are filtered by maximum glazing and south east facing
iv	Influence of solar is removed; random models are filtered by maximum glazing, maximum opening area, and south west facing

2.4 Overheating criteria

There are various criteria which can be used to assess overheating in buildings. In this study, the single overheating criterion as defined in CIBSE Guide A (2006) and the adaptive overheating criteria from BS EN 15251 (2007) were used. CIBSE single temperature criterion

assesses number of hours the indoor operative temperature over 28°C, i.e. for office setting such as this work, overheating is judged if there is more than 1% occupied hours (which corresponds 20 hours over a year) when operative temperature is over 28°C. Adaptive overheating criteria are based on extensive field studies that examine the relationship between indoor comfort conditions and the outdoor environment (Humphreys & Nicol 1998). The limiting comfort temperature T_{comf} defined as BS EN 15251 by:

$$T_{comf} = 0.33Max(10, T_{rm}) + 18.8 \text{ where} \quad \text{Eq. 01}$$

$$T_{rm} = \alpha T_{rm-1} + (1 - \alpha)T_{dm-1} \quad \text{Eq. 02}$$

(T_{rm-1} and T_{dm-1} are the running mean and daily mean temperature previous day)

T_{comf} , as shown in Eq. 01, is no longer a fixed temperature, it varies with the daily running mean temperature (Figure 2). The overheating limiting temperatures in BS EN 15251 were divided into three categories (Category I, II & III) and the upper limit temperatures for these categories are 2°C, 3°C and 4°C, respectively, above the comfort temperature calculated using Eq. 01. Similarly as CIBSE single temperature criterion, the number of hours over these limiting temperatures can be used as a measure of overheating, i.e. number of hours over these upper limiting temperatures should be no more than 3% of total occupied hours (which corresponds around 61 hours) for that specific category the assessment falls within.

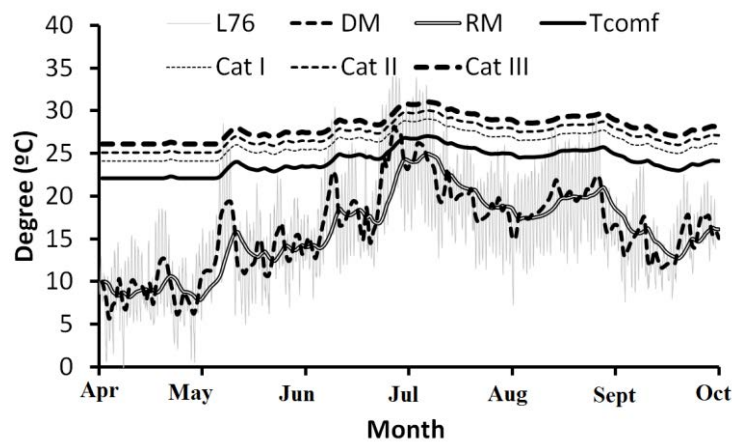

Figure 2: The limiting comfort temperature for the year of 1976 using Eq. 01 for April to September (the upper limits of Category I, II & III would be a parallel shift of T_{comf} by 2, 3 & 4 degree Celsius).

Table 3: Overheating assessment criteria

Index	Description	Unit
c0	Number of hours over 28C during occupancy	[hrs]
c1	adh over 28C during occupancy	[deg.hrs]
c2	BS EN 15251 Category I exceeded during occupancy	[hrs]
c3	adh over Category I during occupancy	[deg.hrs]
c4	BS EN 15251 Category II exceeded during occupancy	[hrs]
c5	adh over Category II during occupancy	[deg.hrs]
c6	BS EN 15251 Category III exceeded during occupancy	[hrs]
c7	adh over Category I during occupancy	[deg.hrs]

As discussed in CIBSE TM52 (2013), overheating occurrence does not always reflect the actual overheating severity which is the accumulated degree hours over limiting temperatures (either a fixed temperature as CIBSE Guide A or varying ones as BS EN 15251). In this work the accumulated degree hours (adh) is calculated the same as CIBSE TM52. The predicted indoor warmth (including both overheating occurrence and severity) is ranked for each individual parametric model from the intended sampling conditions (i to iv in Table 2). A criteria index list is made to facilitate the indoor warmth assessment (Table 3 above).

2.5 Statistical ranking on predicted indoor warmth & sampling

The method for analysing the data is statistical ranking, i.e. to use statistics on the ranking orders of the results. The statistical ranking process is following the method used in Ji et al (2016):

- 1) A random sample of simulation cases is generated from the parametric model.
- 2) Simulations are carried out on the set of sample cases, with each of the 20 London weather years (1976-1995) and the Test Reference Year, respectively.
- 3) Using the results of each simulated case, the 20 weather years are ranked by the predicted indoor warmth using the overheating criteria defined in Table 3.
- 4) The ranks of the weather years of each simulation case, according to each criterion, are collated, so that for each weather year, frequency histograms of the ranks are calculated.

In this work, the Latin Hypercube Sampling (LHS) method is used (Stein 1987). With LHS, a sample size of normally 10 times of the number of variables is sufficient for estimating mean values of the population (*ref* Figure 1, there are 10 varying parameters). As a result, 100 random building models for each weather year will be enough for producing reliable estimation of the average overheating profiles. For the analysis where statistical ranking of the weather years is of interest, the relationship between building characters and their overheating risks under different climatic conditions need to be examined, a larger sample is therefore required. After experimenting, a Quasi-Monte Carlo sample of 2,000 designs for each weather year, generated using the Sobol sequence, was used. Sampling and simulation of the parametric model is managed using the jEPlus tool (Zhang 2009). In total, 42,000 simulations have been performed for the years 1976-1995 plus TRY weather data.

3. RESULTS & DISCUSSIONS

Histograms were produced to illustrate the ranking probability of predicted indoor warmth for each weather year. With 20 years historical weather data, 32 of these graphs were made based on the 4 sets of samples and 8 overheating criteria (Tables 2 & 3). In this work, the analysis is primarily carried out against those warm weather years of interests: the top 6 warmer years (*ref*: Table 1, these years are: 76, 83, 89, 90, 94, 95), with the assumption that one of these weathers will be able to represent the ‘near-extreme’ weather, i.e. being the third warmest.

3.1 The ranking probability of the warmer years

In Figure 3, i to iv + c0 are the ranking probabilities of the 4 sample sets in Table 2 by the number of hours over 28°C for the single zone office space during occupancy. For the year

1976, the probability of being the warmest in terms predicted indoor warmth is only about 32% for the full parametric **Sample "i"**; while this probability increases to 48% when excluding influences of both solar radiation and wind condition (**Sample "ii"** – only dry bulb temperature is the key driver for possible overheating), and to 74% for **Sample "iv"** where the random models have a maximum possible influence of wind speed and direction on top of **Sample "ii"**. There seems to be a tendency that the probability of being the warmest for 1976 increases when the sampling conditions can lead to less number of hours over the limiting temperature. On the contrary, significantly less probability (6%) of being the warmest for the year 1976 was resulted by **Sample "iii"** where the solar radiation is maximized as well as removing the influence of the counter factor of wind in terms of predicted indoor warmth. The year 1989 does not seem to sustain a ranking position with statistical significance apart from for **Sampling "iii"** where its probability of being the warmest is over 80%. For the c0 criterion, it is more likely for the year 1990, 1983 & 1994 to be in the 4th, 5th & 6th ranking position and same is true for the year of 1995 to be in the 2nd ranking position although this is less obvious and with the exception of **Sample "iii"**. For all those concerned years **Sample "iii"** creates a more random order in terms of their ranking probabilities.

Sample "iii" random models emphasize the maximum influence of solar radiation and in the meanwhile excluding wind. This would result the highest level of overheating (by the number of hours over limiting temperatures) among the 4 sampling sets i to iv. The year of 1989 has the highest probability of being the warmest (slightly over 80%). This is ‘unusual’ as the year of 1989 has long been used as a near extreme year, never been deemed the warmest by any of the previous analysis (CIBSE Guide J 2002; Jetsch et al 2014; CIBSE TM49 2014; Ji et al 2016). In Table 1, when varying the base temperatures, the year 1989 has the highest number of hours over 15 °C and 17°C. The random models from **Sample "iii"** have the largest glazing ratio, facing south east (the highest solar gain orientation during occupancy), and no wind. These models may have caused overheating (i.e. indoor operative temperatures are higher than 28°C or the upper limits of the adaptive comfort criteria) when outdoor temperature is below 17°C and this could be the reason why the year 1989 has the highest probability of being the warmest in terms of the predicted indoor warmth.

Similarly as observed in Figure 3 above, when examining the overheating severity (accumulated degree hours over 28°C) in Figure 4, the 4 sampling sets i to iv + c1 show better consistency in terms of predicted indoor warmth ranking probability. The year 1976 is consistently the warmest. Even with **Sample "iii"**, its ranking probability of being the warmest is still as high as 90%. The ranking probability of the year 1989 spreads over 4 or 5 positions in Figure 4. Other years maintain their ranking position well with relatively higher percentage probabilities, in particular for sampling sets i, ii & iv. Unlike the other three sampling sets, the years 1990 & 1995 behave differently for **Sample "iii"**, i.e. the year 1990 stands in the 4th position and the year 1995 has nearly 60% chance in the 3rd position. For all 4 sampling sets in Figure 4, the highest probability ranking position for the years 1983 and 1994 remain unchanged (5th and 6th in ranking). The above observations could be explained by Table 1 where the accumulated degree hours over various base temperatures for these 20 year historical weathers. In Table 1, the year 1976 is consistently the warmest with ADH, while the year 1989 moving from the 5th to the second warmest when the base temperature is 15 °C. The year 1995 is consistently the second warmest in Table 1 and Figure 4 with the exception of **Sample "iii"** where the parametric models of this sample group are prone to cause large number of overheating hours, i.e. when outdoor temperature is 15°C the single zone office space may be already overheated due to maximum possible solar gain, internal heat gains and windless condition. In summary, to some extent Figure 4 does correspond Table 1 reasonably well.

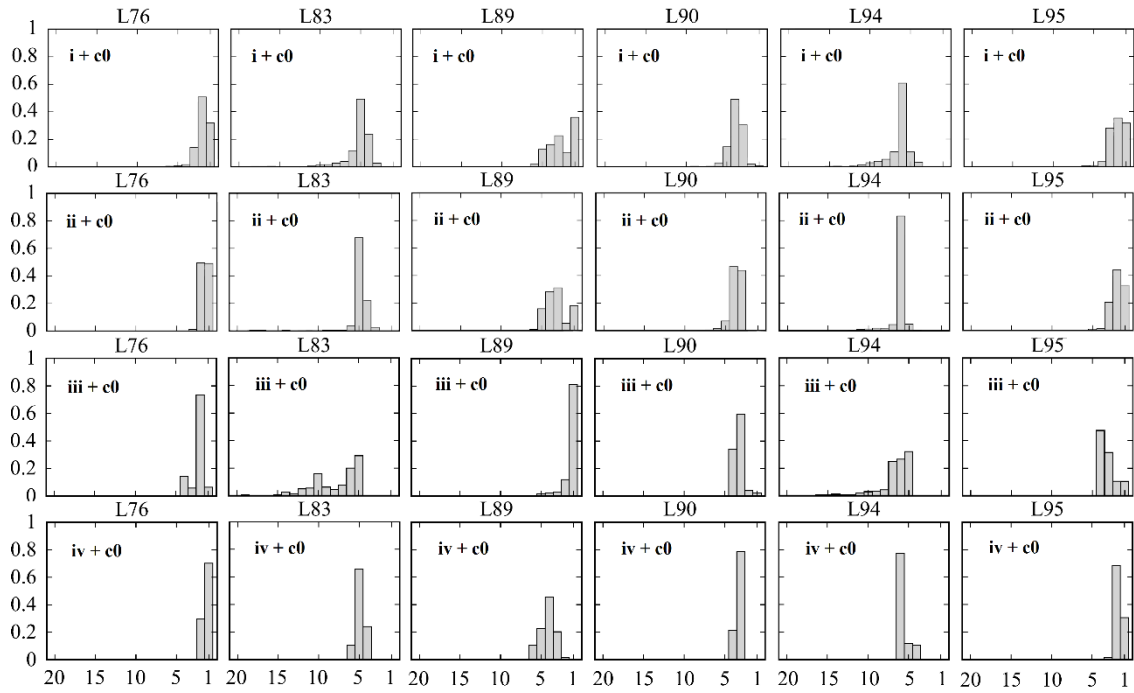

Figure 3: [samples *i* to *iv + c0*] Ranking probabilities by the ‘number of hours over’ 28°C (ref: Table 2 & 3) for the single zone office space during occupancy.

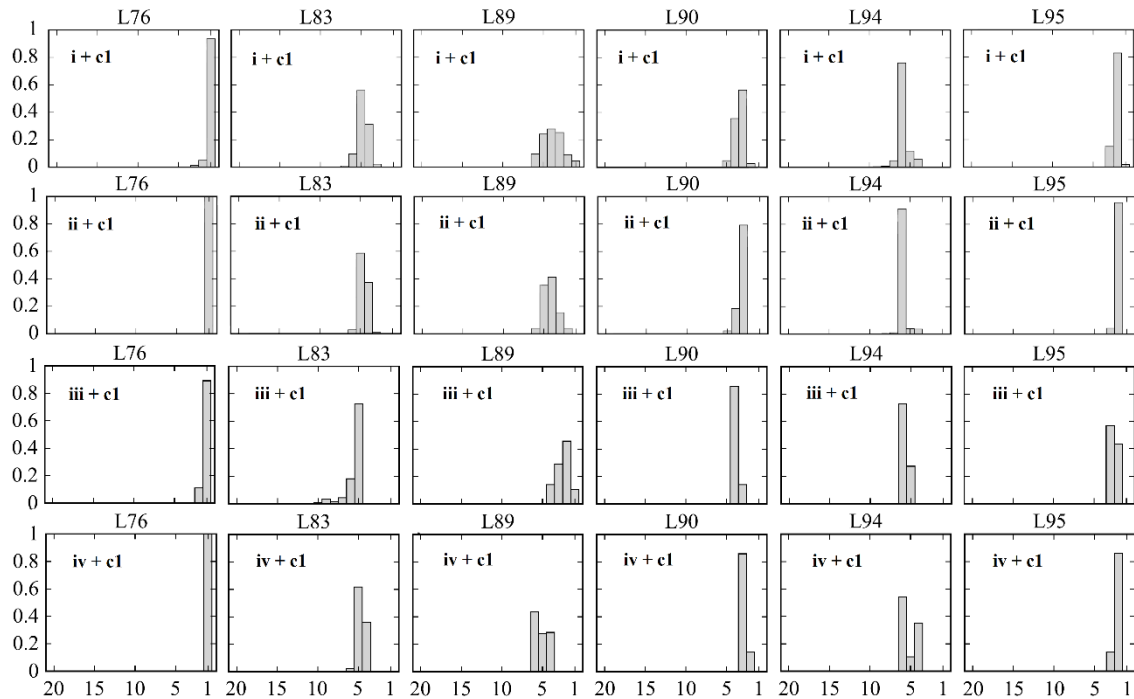

Figure 4: [samples *i* to *iv + c1*] Ranking probabilities by both ‘the accumulated degree hours (adh) over’ 28°C (ref: Table 2&3) for the single zone office space during occupancy.

To a great extent, the ranking probabilities of the six warmer years using the adaptive overheating criteria from BS EN 15251 (Table 3) do behave similarly as those using the CIBSE fixed temperature criterion. What has been discussed in Figures 3 & 4 can also be said for the adaptive criteria although variations do exist. Overall, the year 1976 tends to have higher probability of being the warmest where sampling sets cause less number of hours over, i.e.

Samples "ii" & "iv". **Sample "iii"** is still an 'outlier' as the year 1989 has the highest probability of being the warmest within this group of random models. No strict correlation between any of the discussed outdoor ranking methods (this work and existing literature such as CIBSE Guide J 2002; Nicol et al 2009; Jetsch et al 2014; CIBSE TM49 2014) and the predicted indoor warmth probability ranking was observed. It is clear that thermal responses of various building designs can be very different against the tested 20 years historical weather data in terms of predicted indoor warmth. Judging by the probability ranking of the predicted indoor warmth it is unlikely possible to choose a complete year which can always represent the 'near extreme' or being the third warmest.

3.2 TRY ranking probability

By definition TRY represents an averaged weather condition of the historical weather data from which it is generated. The 11th ranking position in Figure 5 with a higher probability is where ideally it should be. It is clearly not the case. For random model **Sample "i"**, TRY is more likely being 7th warmest based on its highest probability ranking with the 20 source weather years, although for cases 'i + c0' (53%) and 'i + c2' (35%) the highest probabilities are not statistically significant. With the adh over 'i + c1' & 'i + c3', its probabilities of being the 7th warmest are both higher (around 60%). **Sample "iv"** shows more consistent high ranking probability of being the 7th warmest position for all criteria (c0 to c3, table 3). TRY's probability ranking positions vary for random models in sampling sets ii & iii, changing from the 5th warmest position (iii + c2, c3), the 6th warmest position (iii + c0) to the 7th warmest position for remaining cases with the case 'ii+c1' show 90% probability in Figure 5. The above observations on the probability ranking of the predicted indoor warmth for TRY do not correlate well with Table 1 – the highest ranking position for TRY is the 8th warmest in terms of outdoor warmth. With lower base temperatures, the TRY tends to move the middle. The above observation shows that the probability ranking of the predicted indoor warmth for TRY does indicate that TRY is warmer than expected.

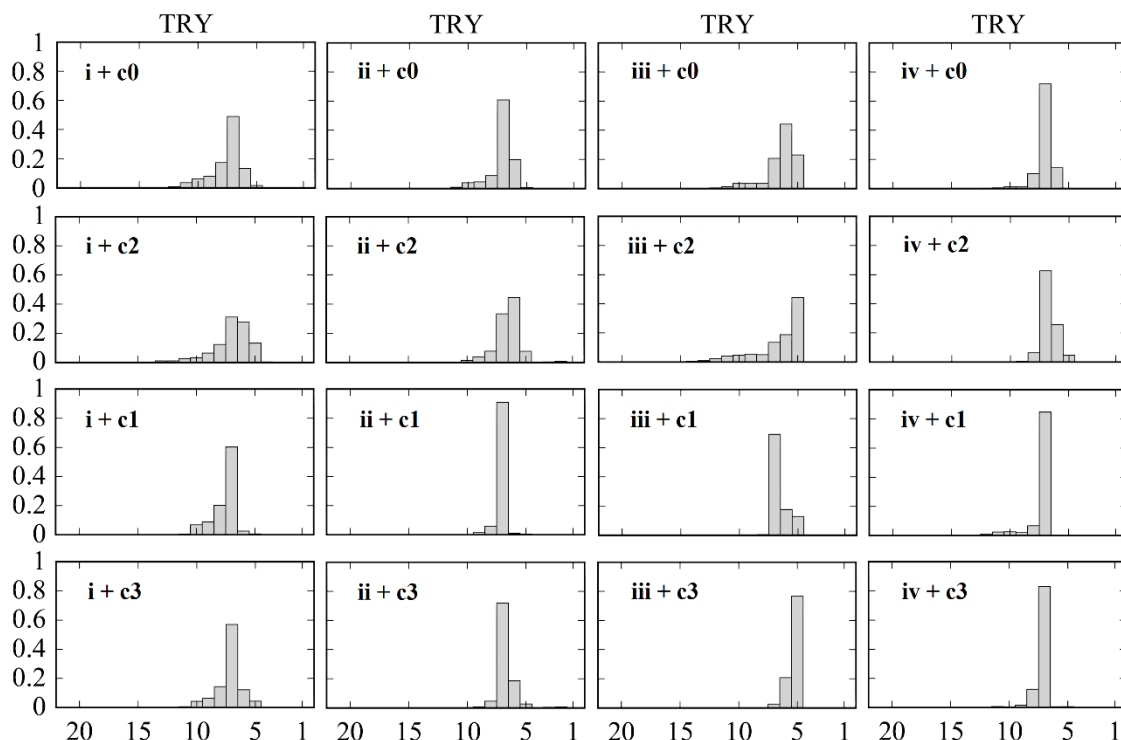

Figure 5: Ranking probabilities for TRY (21 ranking positions) by both 'the number of hours over' and 'adh over' CIBSE Guide A single temperature criterion 28°C and BS EN 15251 Category I upper limit (ref: Table 6) for the single zone office space during occupancy.

3.3 The averaged overheating occurrence and severity

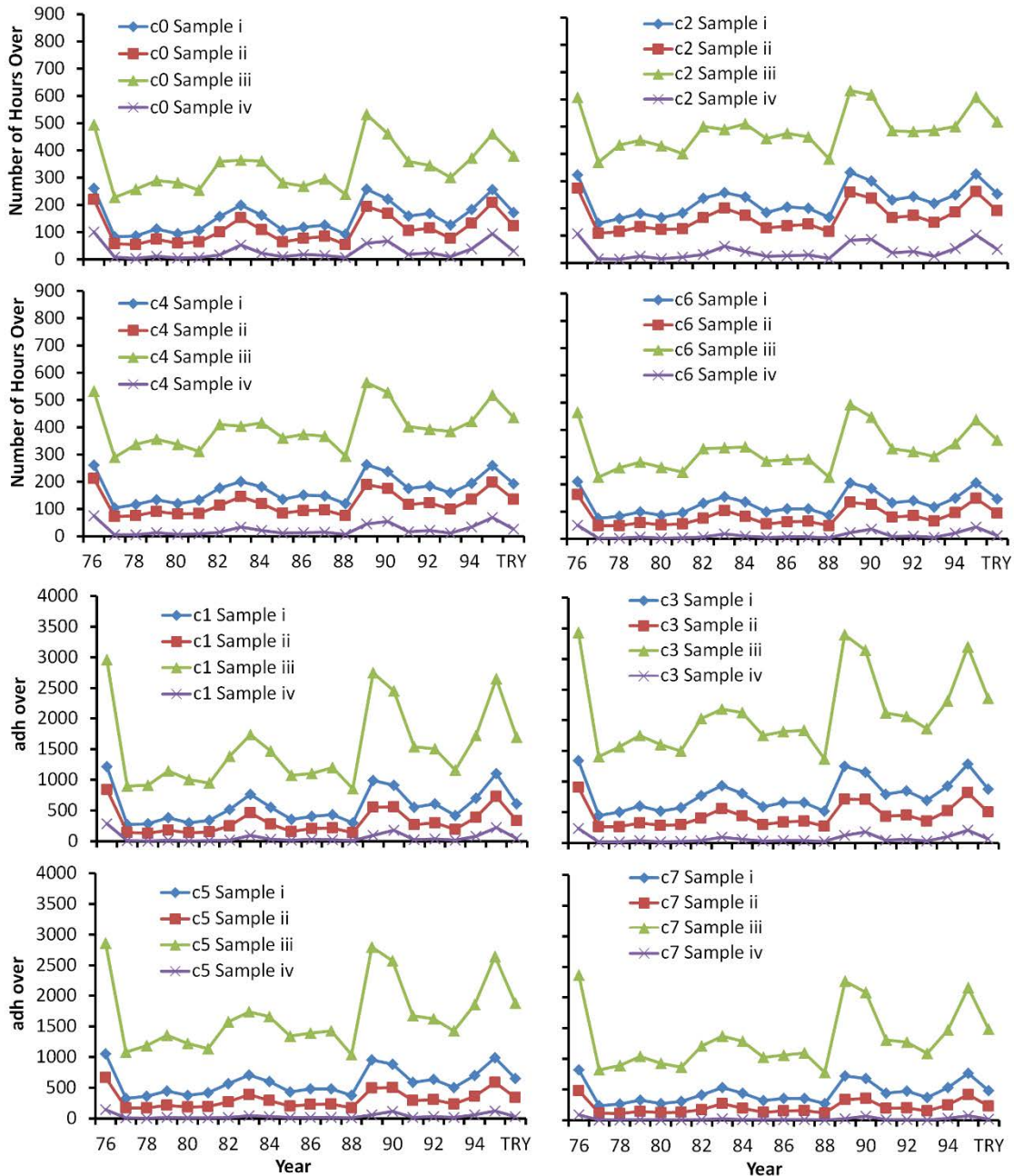

Figure 6: **Averaged** 'number of hours over' and 'adh over' for all 4 sampling sets of random building models (Table 2) against the 8 criteria (Table 3)

The averaged 'number of hours over' 28°C and the upper limiting temperatures from the adaptive Categories I, II & III for each sampling set (Table 2) are shown in Figure 6. In Figure 6, the averaged 'number of hours over' for **Sample "i"** is consistently higher than **Sampling "ii"** which indicates that the combined influence of wind and solar tends to increase the level of overheating. Solar gain is a contributing factor for overheating but for free running buildings

wind is a counter factor. This increase of overheating level means solar radiation plays a more significant role to push the indoor temperature up than wind which tends to cool the indoor temperature down through ventilation. Although the exact quantity of overheating hours for each individual random model is arbitrary the general trend in average term is obvious. It is evident in from Figure 6 that the level of increase in overheating hours for **Sample "iii"** is higher than the level of decrease in overheating hours for **Sample "iv"** when using **Sample "ii"** as a baseline (see table 2). This also confirms the stronger influence on overheating hours from solar than from wind. When examining the averaged 'accumulated degree hours (adh) over' in Figure 6, the observation on the relative influences of solar and wind in overheating prediction is the same. For absolute quantities of the averaged adh over 28°C and adaptive Category I to III limiting temperatures, the year 1989 becomes the second warmest for **Sample "iii"** which is consistent with Figures 3 & 4. Similarly for the averaged 'number of hours over' of **Sample "iii"** in Figure 6, the year 1989 becomes the warmest (as in Figures 3).

4. CONCLUSIONS

This paper sets out to assess the existing definition of standard near extreme weather data. The parametric model was made by a single zone office setting through which both physical changes (size, orientation, glazing, insulation, etc) and operational changes (window opening percentage, internal gains, with or without shading, etc) were randomly modified. The LHS sampling technique was used to generate 4 sampling sets and the building models from these sampling sets were used to examine the impact of building models on overheating assessments. The 20 years historical weather data of London as well as their corresponding TRY were simulated on the sample models of each sampling set. Both single temperature overheating criteria from CIBSE Guide A and adaptive criteria from BS EN 15251 were used to assess overheating in these sample building models. By using a statistical voting procedure, the ranking probability of each weather year on their predicted indoor warmth is presented against both overheating occurrence and severity.

The ranking probabilities of predicted indoor warmth for source weather years show no strict correlation with any existing ranking metrics discussed in this paper. The general observation of warmth from the examined weather years shows that the year 1976 is not always the warmest when using the 'number of hours over' criteria. There is a clear ranking position swap between 1976 and 1989 when the sampling models emphasize the maximized solar radiation scenarios, i.e. the year 1989 has highest probability of being the warmest for **Sample "iii"**. This observation conflicts with most of the existing outdoor warmth definitions apart from the 'number of hours' over lower based temperatures of existing weather data (Table 1). For the 'accumulated degree hours (adh) over' criteria, the year 1976 has been largely consistent of being the warmest with higher ranking probability of predicted indoor warmth. For **Sample "iii"** the year 1989 can become the warmest with the adh over but its probability is much lower than the overheating occurrence cases. Other examined weather years such as 1983, 1990, 1994 & 1995 could not hold any particular ranking position either, but relatively, they are more chances for them to appear in the 5th, 3rd, 6th & 2nd position although they do swap positions with different sampling sets and different criteria used to judge overheating.

For all 4 sampling sets the averaged 'number of hours' and 'adh' over clearly indicates the strong influences from solar radiation and wind speed on the indoor thermal responses. Although the exact 'number of hours' over (for both overheating occurrence and severity) contributed by solar and wind could be random for single zone office models, the averaged

'number of hours' over shows that the influence from solar radiation does outweigh the counter influence from wind induced space conditioning through ventilation. The ranking probabilities of predicted indoor warmth for TRY show that TRY is warmer than expected as its highest ranking probability happens most likely in the 7th position when compared with its 20 source weather years. Even with this 7th position, the statistical significance is not always maintained as for some cases the probability of being the 7th warmest is less than 40%.

It is evident from this research that buildings themselves have significant influences on indoor overheating and the near extreme definitions using historical weather data do not always correlate with the predicted indoor warmth. As shown in this work, it is true that warmer years defined from historical weather data using various methods (i.e. averaged DBT, WCDH, SWCDH, TWCDH, FS statistics on DBT & Solar radiation, etc) are also warmer years based on their predicted indoor warmth ranking probability (1976, 1983, 1989, 1990, 1994 & 1995). However, the exact ranking sequence is not often maintained, i.e. which year is the warmest and which year is the near extreme for individual buildings. This supports the notion of the CIBSE latest release of using pDSYs where multiple weather years are used to cover various types of warmth of historical weather. It is therefore sensible to suggest that more warmer years should be included to make sure one of which can always represent 'near extreme' weather for any individual building design.

5. REFERENCES

- BS EN 15251 (2007). Indoor environmental input parameters for design and assessment of energy performance of buildings addressing indoor air quality, thermal environment, lighting and acoustics. BSI, EN 15251 (E).
- CIBSE Guide A (2006). Environmental Design, London: The Chartered Institution of Building Services Engineers, ISBN-13: 978-1-903287-66-8.
- CIBSE Guide J (2002). Weather, solar and illuminance data, London: The Chartered Institution of Building Services Engineers London, ISBN 1 903287 12 X.
- CIBSE TM48 (2009). Use of climate change scenarios for building simulation: the CIBSE future weather years, London: The Chartered Institution of Building Services, ISBN 978-1-906846-01-5.
- CIBSE TM49 (2014). Design Summer Years for London, The Chartered Institution of Building Services Engineers London. ISBN 978-1-906846-27-5.
- CIBSE TM52. The Limits of thermal comfort avoiding overheating in European buildings. ISBN 978-1-906846-34-3, © July 2013 The Chartered Institution of Building Services Engineers London.
- Humphreys M.A. & Nicol J.F. (1998) 'Understanding the adaptive approach to thermal comfort', ASHRAE Trans, 104(1): 991 - 1004.
- Jentsch M F, Eames M E & Levermore G J (2015). Generating near-extreme Summer Reference Years for building Performance simulation. *Building Serv. Eng. Res. Technol.*, 36(6): 701-727.
- Jentsch M F, Levermore G J, Parkinson J B & Eames M E (2014). Limitations of the CIBSE design summer year approach for delivering representative near-extreme summer weather conditions. *Building Serv. Eng. Res. Technol.*, 35(2): 155-169.
- Ji Y, Zhang Y, Korolija I & Futcher J (2016). Design summer year weather – outdoor warmth ranking metrics and their numerical verification. *Building Serv. Eng. Res. Technol.*, 37(6): 639-643, DOI: 10.1177/0143624416648179
- Levermore G & Parkinson J (2006). Analyses and algorithms for new Test Reference Years and Design Summer years for the UK. *Building Services Engineering Research and Technology*, 27(4): 311-325.
- Nicol J, Hacker J, Spires B & Davies H (2009). Suggestion for new approach to overheating diagnostics. *Building Research & Information*, 37(4): 348-357.
- Smith S T & Hanby V (2012). Methodologies for the generation of design summer years for building energy simulation using UKCP09 probabilistic climate projections. *Building Serv. Eng. Res. Technol.*, 33(1): 9-17.
- Virk D & Eames M (2016). CIBSE Weather Files 2016 release: Technical Briefing and Testing.
- Steadman, P., Bruhns, H. R., Holtier, S., Gakovic, B., Rickaby, P. A. & Brown, F. E. (2000). A classification of built forms. *Environment and Planning B: Planning and Design*, 27 (1): 73-91.
- Stein, M. (1987) 'Large Sample Properties of Simulations Using Latin Hypercube Sampling'. *Technometrics*, 29(2): 43-151

Zhang Y. "Parallel" EnergyPlus and the development of a parametric analysis tool. 11th International IBPSA Conference, pp 1382-1388, July 27-30, 2009, Glasgow, Scotland.

COMBINED IMAGING TECHNOLOGIES FOR MEASURING THE IN-SITU THERMAL AND ACOUSTIC ENERGY EFFICIENCY OF RETROFIT BUILDING ELEMENTS

N. Patil¹, A. Marshall², R. Fitton² and D. Waddington¹

¹ *School of Computing Sciences and Engineering, University of Salford, The Crescent, M5 4WT, UK*

² *School of Built Environment, University of Salford, The Crescent, M5 4WT, UK*

Email: n.patil@edu.salford.ac.uk

Abstract: Awareness of the impacts of climate change, fuel poverty and a demand for energy efficiency has prompted significant changes in design and construction of modern homes. This in part can be achieved by installing energy efficient building elements such as windows, curtains, doors, etc. Thus the aim of this study was to develop a combined imaging system for measuring the thermal and acoustic efficiency of retrofit building elements in modern homes. A case study is presented for measuring the thermal and acoustic efficiency of tweed curtains on a double sash window as a part of a collaborative, interdisciplinary project involving the Acoustics Test Laboratories and the Energy House at University of Salford. The thermal efficiency was quantified by measuring U-values of the curtain and the window. The acoustic efficiency of the curtain was quantified by its 'Sound Insulation'. Using the Microflown PU acoustic probe, the insertion loss was measured as well as the noise break-in was assessed for ventilated case-when the window is opened. These parameters are measured in-situ and may be used to compliment qualitative comfort values. Combining the quantitative and qualitative parameters may provide a step in implementing design guides for modern homes with different physical environments.

Keywords: Acoustic Efficiency, Energy House, Sound Insulation, Thermal Efficiency, U-Values

1. INTRODUCTION

Awareness of the impacts of climate change, rising energy prices, fuel poverty and a demand for energy security have prompted significant changes in design thinking, construction practice, building materials and building legislation aimed at reducing energy use and carbon dioxide emissions. A particular example of this is the fabric first approach and increasing requirements for air-tightness in housing. Whilst this achieves a primary objective of reducing heat loss and noise break in through ventilation, there is growing evidence that the requirements for healthy ventilation have not kept pace with these developments, and there is emerging evidence of poor indoor air quality and inadequate ventilation. However, ventilation may affect the thermal and acoustic comfort of the occupants depending on the physical environment.

The long term objective of this project is to devise a novel applications of remote sensing and imaging techniques to facilitate the bringing together of public health and building professionals together with architects and their clients to investigate shared research questions, with the overall aim of supporting the design of healthy, low energy homes.

2. AIMS AND CONCEPT

The study was conducted to use imaging techniques for the investigation of noise and thermal transfer through a retrofit window. The following imaging techniques were investigated tested and analysed by post processing techniques.

2.1 Acoustic imaging –beamforming and nearfield holography

Acoustic imaging and localisation in the far field is usually done by beamforming a number of signals recorded by a microphone array known as the acoustic camera. The beamforming can be done in 2D or 3D manner depending on the location of sound sources and direction of incoming sound. Raman et al. [1] utilised 2D beamforming in the outdoors for locating air leakages in a window of a room and compared leak detection method used in standard airtightness testing. Our previous work [2] showed that 2D beamforming in a reverberant environment (inside the room) did not give satisfactory results due to reflection issues from the walls. Schröder et. al. [3] demonstrated an approach using the 3D spherical acoustical camera to evaluate the interior surroundings of a room. Different properties such as RT, absorption and reflection, and sound isolation were measured which showed the weak spots or the noise leakage in a door of the room they tested. Barre et. al. [4] demonstrated the use of time domain beamforming using impulse responses (sine-sweep) to analyse leaks in a plate installed between two rooms at high frequencies. From these studies, use of 3D Beamforming seems reasonable to investigate for leakage detection in buildings.

The Microflown P-U probe used for the study is a nearfield solution for analysing the sound fields and localising sources. It measures the pressure and the particle velocity in three directions using the principle of a hot wire anemometer. For compressed air leaks, Microflown first demonstrated the application to detect a leak as low as 7×10^{-6} bar l/s, however this was possible by using a nozzle attachment at the particle velocity probe [5]. Instead of using compressed air sound waves can be transmitted through leaks which can also be measured with the probe. Vecchio et. al. [6] used the Microflown probe to detect an artificially generated acoustic leakage in the sealing of a car lateral window at high frequencies. Comesana et. al. [7] demonstrated the use of Scan & Paint technology with the Microflown probe. Scan and Paint creates a colour map of the acoustic properties on the image of the scanned structure. The authors performed broadband mapping (50 to 5000 Hz) of sound pressure, particle velocity, and acoustic intensity on a door excited by airborne sound. It was observed that, while the pressure roughly indicates where the noise is coming from, particle velocity mapping shows even the weaknesses at the door profile, demonstrating the high spatial resolution of the measurement method.

2.2 FLIR thermal imaging sensor

The instrument used for the thermal imaging experiments was a Flir B425 thermal imaging camera. This device has an accuracy of +/- 2 degrees Celsius and a sensitivity of 50mK. This device functions on the principle of detection of radiative heat exchange which is present in all materials above absolute zero. This principle can be used to collect visual data on the surface temperature of elements; this can be useful when comparing scenarios such as insulated and uninsulated structures, or detecting gaps in insulation measures [8]. The thermal imaging

camera is not applicable for recording surface temperatures of reflective materials such as glass; the equipment was only used when the windows were covered with curtains.

2.3 U-value measurement

U-values are a well-defined internationally recognised unit of measure for the thermal transmittance of a building element, in this case a window. The unit gives a measure of the number of Watts (W) passing through a square metre (m^2) of the material for a given difference in temperature in Kelvin (K) and its units are W/m^2K [9]. To estimate a U-value three measurements are needed; heat flux, internal temperature and external temperature.

3. TEST METHODOLOGY

The tests were carried out in the Energy house at University of Salford. The Energy House at University of Salford (Fig. 1) is a full scale house built inside an environmental chamber. The environmental chamber is controlled and different environmental conditions can be simulated, for ex., rain, wind and sub-zero temperatures. The building in the chamber can then be tested with different materials under a controlled environment.

3.1 Scan and paint

To diagnose the sound transmission through the window, the Energy house compound was excited by a loudspeaker driven by pink noise excitation. A sound field is set up around the energy house and this causes the sound to be transmitted to the bedroom from paths such as the window and any leaks/openings in the window. Using the P-U probe, a scan was conducted over the window to measure the pressure and acoustic particle velocity normal to the window inside the room. Using Scan and Paint technology, these scanned quantities were mapped on the window. At first, the window was scanned fully closed (to detect leaks) and then with three window openings (5, 15 and 24 cm) with and without curtain to measure the sound transfer. The window chosen for the study is shown with the loudspeaker outside the house in Figure 1.



Figure 1: the energy house (left), the window tested (centre) and the loudspeaker in the house compound (in blue, right)

3.2 Sound insulation measurement

To measure the sound insulation of the curtain, the sound power inside the room with and without the curtain has to be measured as per ISO 11546-1 [10]. The sound power can be measured by a pressure method or sound intensity method. In our study, we have used the sound intensity method where the PU probe is scanned over the measurement surface (window/curtain). The resulting sound intensity multiplied by the measurement surface area gives the sound power. The insertion loss of the curtain will be dependent on different openings of the window. Bearing this in mind three different openings (15 cm, 30 cm, and 62.5 cm) of the window were tested. The sound intensity was measured by scanning the probe close to the window. Adequate care was taken to maintain the test standards as per the recommendations of ISO 9614-2 [11], which provides guidelines for testing the sound intensity, by a scanning method. The window was first tested without any curtain covering which forms the base or reference test.

Next the curtain was hung and closed on the window. Again for the three openings, the sound intensity normal to the curtain surface was measured. However with the curtain installed there are other paths of sound transfer into the room namely around the edges of the curtain. This is illustrated in Figure 2. Thus, this area has to be accounted for and accordingly scans were performed on these areas. The sound intensity for each surface was multiplied with its area to give the sound power. All the sound powers were finally added to give the total sound power injected into the room when the curtain is installed. Notice that such summation exercise is not performed for the reference case as there is only one area which contributes to the sound transfer.

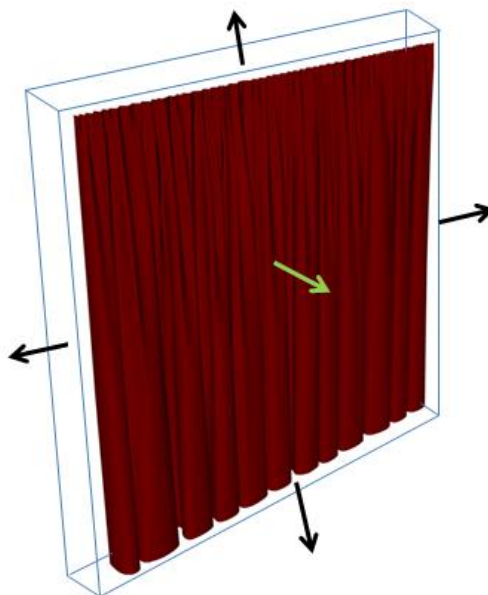

Figure 2: The curtain with the areas around the edges represented by a normal sound intensity vector (in black arrows), the back surface is the window

3.3 Thermal imaging methodology

For the thermal tests a temperature difference inside and outside of the house is produced. If this is of greater than 10 degrees Celsius then thermal imaging is able to suggest dominant

paths of heat transfer into the enclosed space. This is also a commonly used method to identify air leakage paths at weak points and gaps in the structure. The thermal camera was set up to capture thermal images of the internal face of the window covering. The images were taken at the end of the test when a steady state temperature had been reached at the curtain surface.

3.4 U value measurement

An array of Hukseflux HFP01 heat flux plates are fixed to the internal surface of the glass (Figure 3). On both internal and external surfaces are thermocouples which record the temperature; data is collected at intervals of 1 minute. The method for calculating U-value, as used by Wood et. al. [12], combines heat flux, surface temperatures and surface thermal resistances, as set out for the average method in [9]. Each experiment observes the U-value across a test period during which heat is applied to the room. A heater is situated to the rear of the room so as to allow heat to circulate around the room. This is done to initiate steady state conditions within the room and thus through the tested element. A set point of 22°C is used for the room, while the external temperature is regulated to approximately 5°C using a dedicated HVAC system. This temperature difference of above 10K was used to promote mono-directional heat flow through the element.

$$U = \frac{1}{\left(\frac{T_I - T_E}{Q}\right) + R_{SI} + R_{SE} + \varphi} \quad (1)$$

Where T_I is the internal surface temperature (K), T_E is the external surface temperature (K), Q is the heat flux through the element ($\text{W m}^{-2} \text{K}^{-1}$), R_{SI} is the internal surface thermal resistance ($\text{m}^2 \text{KW}^{-1}$), R_{SE} is the external surface thermal resistance ($\text{m}^2 \text{K W}^{-1}$), φ is the resistance of the heat flux plate ($6.25 \times 10^{-3} \text{ m}^2 \text{K W}^{-1}$).



Figure 3: U-value measurement setup showing positions of heat flux sensors (left) and with tweed curtain (right)

4. RESULTS

4.1 Acoustic imaging and sound insulation

With the loudspeaker active, the probe was scanned on the window in all configurations and the particle velocity and pressure were mapped using the Scan and Paint technology. Figure 4 shows the scans for the window closed case to detect areas of leakage in the one-third octave bands of 1 kHz and 2 kHz. From the scans it is evident that the leakage areas are present between the junctions of the two window frames. Although in some cases leaks could be detected by visual inspection, this method can detect leaks which are very small and not discernible from visual inspection. In addition, the scans provide the acoustic nature of the leaks.

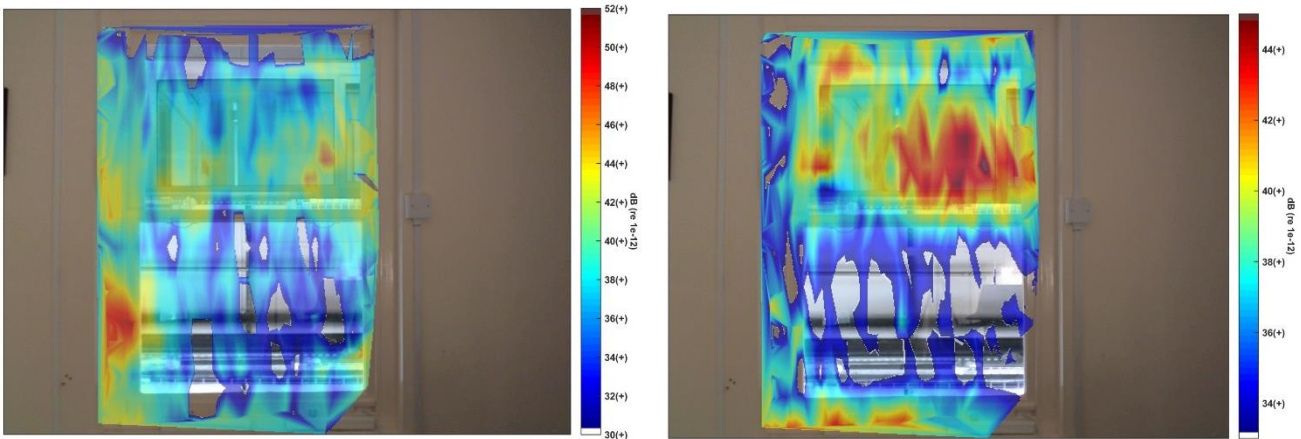

Figure 4: Sound intensity map of the closed window in 1 kHz band (left) and 2 kHz band (right) showing areas of leakage (in red)

Figure 5 shows the sound insulation of the tweed curtain for different opening cases. Results are presented in one-third octave bands from 160 Hz-4 kHz. It can be seen that as the window opening decreases the sound insulation of the window tends to increase by a small amount. Also the sound insulation of the curtain in the low frequency range (<200 Hz) is negligible and has high uncertainty as the test was performed in a reverberant environment where intensity methods can provide inaccurate results in low frequency region.

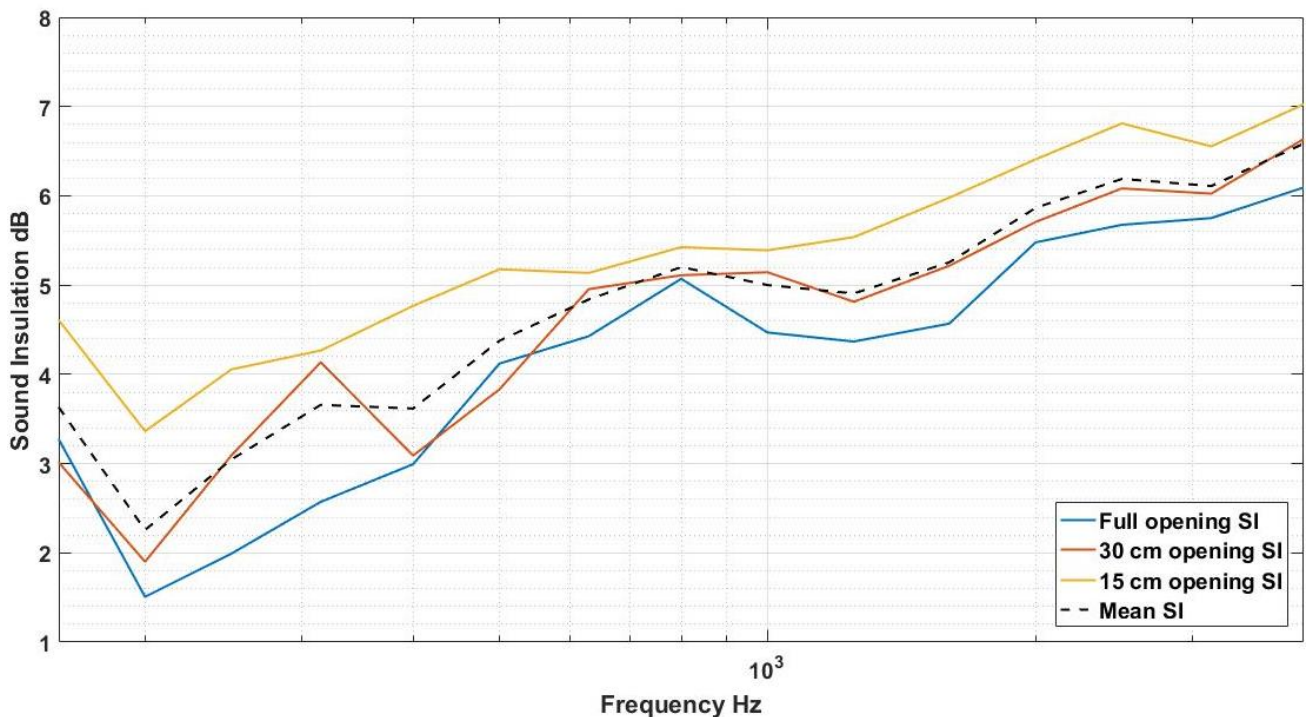

Figure 5: Sound insulation of the tweed curtain measured for different openings of the window in one-third octave bands

4.2 Thermal imaging and U-value results

Figure 6 shows the thermal imaging results for the closed window case (with and without curtain).

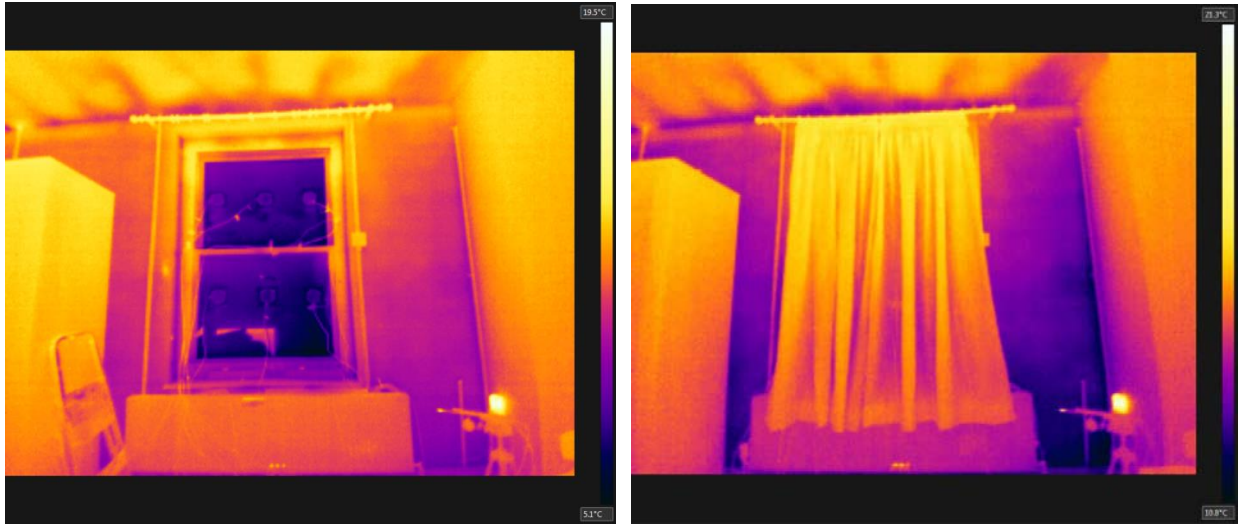

Figure 6: Thermal image of window with no curtains (left), thermal image of the tweed curtains (right)

It is important to note that thermography is not generally used on reflective surfaces; therefore the results for the naked window are illustrative. Thus any weak spots detected on the window may be inconclusive for leak detection.

Table 1 show the U-values of the window glazing with and without the curtains. The test setup can be seen in Figure 3. Again a clear reduction in U-values can be seen when the curtain is used demonstrating its effectiveness in reducing the thermal transfer in the room.

Table 1: U-value measurements with and without curtains

Test	Element	Average U-value Top (W/m ² K)	Average U-value Bottom (W/m ² K)	Average U-value Overall (W/m ² K)
1	Glazing with no curtains	4.6	4.4	4.5
2	Tweed Curtains	2.9	3.0	2.9

5. CONCLUSIONS

The aim of the study was to investigate combined acoustic and thermal imaging techniques to investigate the leakage and thermos-acoustic transfer through a retrofit building element –a window in this case. To detect leakage, although thermal imaging has been used in studies previously, it may give misleading results when thermal imaging is applied on a transparent structure. Also a temperature difference between indoors and outdoors has to be maintained. A simple way around this is to excite the structure with sound waves such that sound transfers through the leaks take place. Using the Microflow P-U probe, the leaks were detected using sound intensity mapping of the window.

A methodology was presented to test the sound insulation of curtains in-situ. A tweed curtain was tested for its sound insulation and the sound insulation of the curtain increased as the window opening decreased. Rating the acoustic performance of curtains by their mean sound insulation may provide a way for choosing the right curtain subject to the physical environment.

Thermal imaging offers a different technique to qualitatively detect locations for leakage and thermo-acoustic transfer by illustrating the relative difference in the intensity of infra-red radiation emitted by a surface element. In cases where a particular region on the surface of an element experiences higher thermal transmission than the surrounding areas – such as where leakage may be detected through air permeation or structural defects – the region would appear colder. Although this technique is suitable for the visualisation of data, it lacks the capacity for quantitative analysis and so quantification of fabric performance parameters, for example the U-value, relies on a more inclusive technique. Thermal imaging also faces an obstacle where reflective or transparent surfaces are considered, as infra-red radiation from other sources can be transmitted from and through the surface to give an inaccurate representation of the actual condition at that surface.

In order to explicitly differentiate between an unobstructed glazing element and one which incorporates tweed curtains, it is necessary to state the U-value of each glazing permutation. Following the method outlined in BS ISO 9869-2014, measurements of heat flow and internal / external temperatures were taken over a period of 14 hours under steady state conditions. The average method was then employed to calculate the average centre-pane U-values, as indicated in table 1. By quantifying the average thermal transmission across the centre-pane element with and without the curtain, a difference in this thermal transmission of 37% is identified. Rather than simply illustrating relative thermal transmissions and areas of leakage, the technique presents a figure for this disparity. The disadvantage of using thermal imaging and the average U-value method is inherent in each procedure, in that both methods require steady state conditions to be established. For leak detection then, acoustic imaging takes the advantage in providing rapidity of both measurement and result analysis.

6. REFERENCES

- Raman, G., Prakash, M., Ramachandran, R.C., Patel, H. and Chelliah, K., 2014. Remote detection of building air infiltration using a compact microphone array and advanced beamforming methods. In *Berlin Beamforming Conference, Berlin*.
- Patil N., WongMcSweeney, Benjaber M., Fitton R., Elliott A., Waddington D., 2016. Feasibility study on using acoustic camera for acoustic imaging to detect air leaks in a structure. In *Proceedings of the IOA conference, Kenilworth, UK*.
- Schroder, R., Meyer, A., Dobler, D., Heilmann, G. and Ohm, M., 2011, July. Fields of application for three-dimensional microphone arrays for room acoustic purposes. In *INTER-NOISE and NOISE-CON Congress and Conference Proceedings* (Vol. 2011, No. 6, pp. 1768-1774). Institute of Noise Control Engineering.
- Barre, S., Dobler, D. and Meyer, A., 2014, October. Room impulse response measurement with a spherical microphone array, application to room and building acoustics. In *INTER-NOISE and NOISE-CON Congress and Conference Proceedings* (Vol. 249, No. 2, pp. 5467-5472). Institute of Noise Control Engineering.
- De Bree, H.E., 2007. The microflown e-book. *Microflown Technologies, Arnhem*.
- Vecchio, A., Valent, L., Berthe, A. and Debree, H.E., 2006, April. The Microflown, a novel approach to helicopters interior noise testing. In *Instrumentation and Measurement Technology Conference, 2006. IMTC 2006. Proceedings of the IEEE* (pp. 584-589). IEEE.
- Comesaña, D.F., Steltenpool, S., Carrillo Pousa, G., de Bree, H.E. and Holland, K.R., 2013. Scan and paint: theory and practice of a sound field visualization method. *ISRN Mechanical Engineering, 2013*.
- EN, B., 1999. 13187: 1999, Thermal performance of buildings—Qualitative detection of thermal irregularities in building envelopes—Infrared method. *BSI, London*.
- ISO, B., 9869-1: 2014 Thermal insulation, Building elements, In-situ measurement of thermal resistance and thermal transmittance-Part 1: Heat flow meter method. *BSI, London*.
- ISO, B., 11546-1: 2009, Acoustics. Determination of sound insulation performances of enclosures. Measurements under laboratory conditions (for declaration purposes). *BSI, London*

ISO, B., 9614-2: 2013, Acoustics -- Determination of sound power levels of noise sources using sound intensity -- Part 2: Measurement by scanning. *BSI, London*.

Wood, C., Bordass, B. and Baker, P., 2009. Researching into the thermal performance of traditional windows: timber sash windows.

THERMAL CONDITIONS WITHIN THE CAMPUS OF UNIVERSITY OF SALFORD, UK

M. Taleghani, R. Fitton and W. Swan

School of the Built Environment, University of Salford, Manchester, UK

Email: m.taleghani@salford.ac.uk

Abstract: The urban heat island (UHI) phenomena is defined as the air temperature difference between a city and its suburbs. The UHI in Manchester (UK) reaches to 5 °C during summer time. Several studies have shown the impact of UHI on human thermal comfort and energy consumption in buildings. Computer modelling makes it possible to explore the impact of different urban elements within a neighbourhood on the thermal conditions. In this paper, the campus of University of Salford is modelled in a computational fluid dynamic (CFD) program. The campus is simulated for a summer heat wave to study the extreme situation. The impact of different land cover (such as asphalt pavements, vegetation and buildings) on outdoor thermal comfort will be discussed. This campus is very close to the city centre of Manchester, therefore, the understanding of the thermal conditions of the campus is used to propose practical solutions to mitigate heat at the city centre.

Keywords: Heat Mitigation Strategies, Outdoor Thermal Comfort, University Campus, UHI

1. INTRODUCTION

Heat in urban spaces can have dangerous consequences on health (Epstein & Moran, 2006; Oke, 2002). Several studies have shown that ongoing global warming has made the heat waves the first natural cause of mortality in USA (Anderson & Bell, 2009; Hajat & Kosatky, 2010). People in indoor environments have the ability to change clothes, drink cold liquids or other solutions to cool themselves. However, urban open spaces are not generally designed to protect people against natural events such as heat waves.

In this study, the climatic conditions of the open spaces of the campus of the University of Salford is investigated. Exploring the climatic conditions of the campus provides two benefits:

- a) It helps to understand which area(s) on the campus have the potential to impose heat stress to people during summer time, therefore, identifying areas where heat mitigation solutions could be implemented to make these areas comfortable.
- b) It indicates the possible range of the air temperatures surrounding the University buildings. Therefore, we can estimate which buildings will consume more energy for cooling during summer time. We can then take actions to reduce the outdoor air temperature for those critical buildings.

The outdoor environment of the campus is simulated with a CFD program, ENVI-met (Bruse, 2004). This program simulates the spatial distribution of micrometeorological factors (such as air temperature and wind speed). At the end, the temperature at different locations will be compared with additional evidence, including thermal photos from the site.

2. METHODOLOGY

The weather within the campus of the University of Salford has been measured by a weather station in 2016. The weather station was located on the roof of the Energy House building, and measured air temperature, wind speed and direction, relative humidity, precipitation and solar radiation. This weather data was used to find the hottest day in 2016 (19 July). The early morning weather data of the hottest day was used to run the CFD simulations, as the initial weather data. The CFD model, ENVI-met, needs a configuration model (defining land cover), and a weather data to initiate the simulations. This initial weather data are described in Table 1.

Table 1: The initial condition of the ENVI-met simulations.

Location	Salford, Manchester, UK
Domain area (x, y, z)	240 x 240 x 20
Spatial resolution (x, y, z)	2 x 2 x 4
Simulation day and period	19.07.2016, 24 hours
Initial air temperature	18.4 °C
Initial wind speed and direction	1.7 m/s, North (9 deg)
Initial relative humidity	90.5

The campus of the University of Salford was modelled in ENVI-met based on the actual land cover retrieved from Google Maps. The campus is surrounded by a highway (south), a vegetated park (north and east), and a railway (west). Figure 1 shows an aerial view of the modelled area (in a red box).



Figure 1: An aerial view of the simulated area.

3. RESULTS

Figure 2 shows the air temperature within the campus at the height of 1.2m at 16:00. At this time of the day, the maximum air temperatures occurred (16:00), and 1.2m height is the closest height to pedestrians' level. The air temperature ranges between 27 °C (park in the north east) to 32 °C (west and north parts).

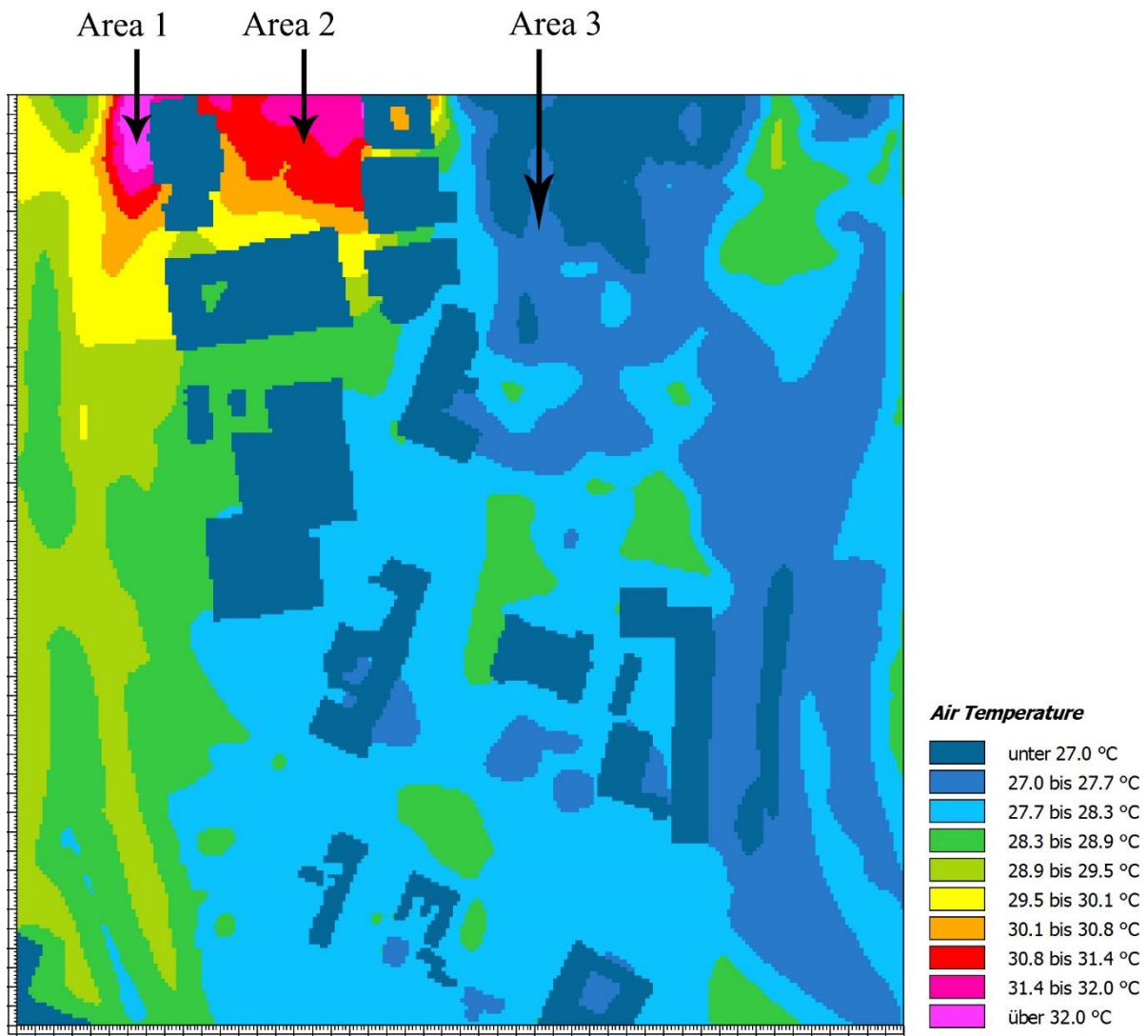

Figure 2: Distribution of air temperature at the height of 1.2m at 16:00.

Three areas on the north side of the campus are shown in Figure 2. These areas show the hottest (1 and 2), and coldest (area 3) parts of the campus. To have a better understanding about the impact of their land cover on air temperatures, thermal photos have been taken from these areas on 02.05.2017. Figure 3 shows the actual areas together with their corresponding thermal photos. It should be noted that thermal photos show the surface temperature (which is different than air temperature).

In area 1, a railway line runs from the south west of the campus towards the north west. The railway is covered with dark gravel. This makes the railway hotter than the vegetated areas. In the thermal photos of the railway, the shaded gravel has a range of 15C between the warmest, radiated areas, and the coolest areas.

In area 2 of the campus, there is a large area paved by stones. With a high heat capacity, stones can absorb solar radiation. The thermal photo of area 2 shows the black stones are significantly hotter than white stones.

Area 3 is the campus park. The shaded grass in the park has the lowest surface temperatures (13.3 °C). Due to the construction in the park, some grass areas are destroyed, and have visibly higher temperatures. The asphalt pavement within the park has the highest surface temperature (29.7 °C).

Area 1



Area 2

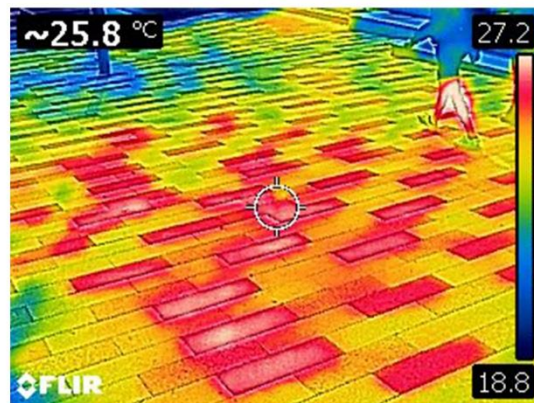
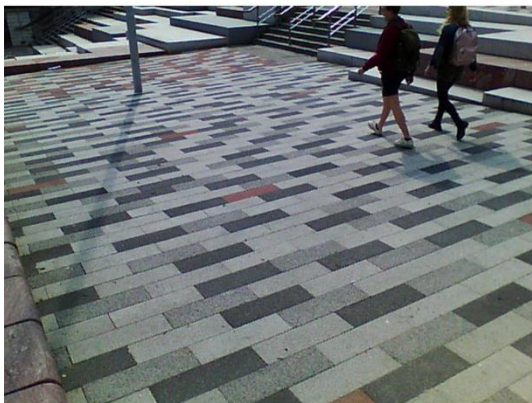

Area 3

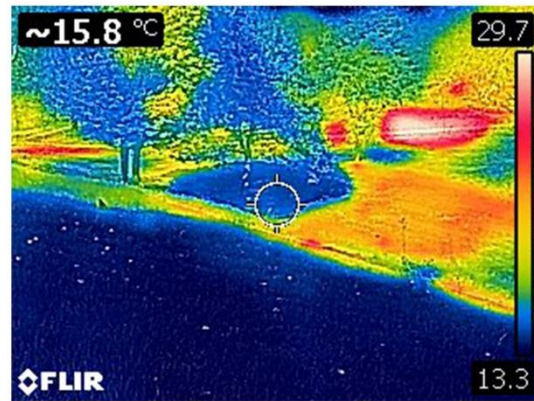

Figure 3: Three areas highlighted in Figure 2, their actual land cover (left) and surface temperatures (right).

4. CONCLUSIONS

This paper investigated the thermal condition within the campus of University of Salford. CFD simulations were done for the hottest day of 2016 (19 of July). The simulation of air temperature at the height of 1.2m showed that the vegetated campus park with 27 °C was the coolest area of the campus at 16:00. The hottest areas were a paved area with stones, and the railway at the west part of the simulated area (with temperatures up to 32 °C at 16:00). At the next step, thermal photos taken from the campus park showed that shaded and unshaded grass have a large surface temperature differences. The thermal photos from the railway also showed appreciable temperature difference between the shaded and unshaded gravels. This finding shows that shading has a significant effect on the surface temperatures in urban spaces (even in vegetated environments).

These findings show how important is the role of land cover for having a cooler city. Implementing more vegetation, and shading in cities make them more resilient for future climates. This study was a pilot project, and authors will focus on the thermal conditions within the city centre of Manchester.

5. REFERENCES

- Andersona, B. G., & Bell, M. L. (2009). Weather-Related Mortality, How Heat, Cold, and Heat Waves Affect Mortality in the United States. *Epidemiology*, 20(2), 205-213.
- Bruse, M. (2004). *ENVI-met 3.0: Updated Model Overview*. Retrieved from <http://www.envi-met.com/documents/papers/overview30.pdf>
- Epstein, Y., & Moran, D. S. (2006). Thermal comfort and the heat stress indices. *Industrial Health*, 44, 388-398.
- Hajat, S., & Kosatky, T. (2010). Heat-related mortality: a review and exploration of heterogeneity. *J Epidemiol Community Health*, 64(9), 753-760. doi:10.1136/jech.2009.087999
- Oke, T. R. (2002). *Boundary Layer Climates*: Taylor & Francis.

THE RECYCLING OF PLASTIC BOTTLES AS A COMPOSITE CONCRETE BLOCK TO INCREASE THE EFFICIENCY OF BUILDING INSULATION

T. Waroonkun, T. Paungphinyo and S. Prugsiganont

Chiang Mai University, Chiang Mai, Thailand

Email: tanut.w@cmu.ac.th

Abstract: A bottle of water that is available in supermarkets or convenient stores is mainly made of plastic. However, the process of plastic disposal is complicated and the recycle rate is very low, dramatically increasing the amount of plastic waste in recent years. One of the major ways to reduce this waste is to reuse plastic bottles. Consequently, some modern plastic bottles are being recycled as architectural components. This study focuses on the production of concrete blocks by using plastic water bottles as a major component of the block. Each concrete block was created with a different size and type of plastic bottle. The blocks were later tested for the efficiency of insulation. The results showed that the most efficiently insulated concrete block was the block that contained a 1000 millilitre plastic bottle. The 1000 ml bottle is the largest plastic water bottle available in the market that provides the best insulation.

Keywords: Concrete Block, Insulation, Plastic Bottle, Recycle

1. PURPOSE OF THE STUDY

The advancement of technology has brought many conveniences to everyday life. One such convenience was the invention of the plastic container. The popularity of plastic containers has led to a dramatic increase in plastic disposal. However, the plastic recycling process in Thailand is still complex, difficult, and expensive. The Pollution Control Department (2002) stated that only 30% of the total amount of plastic waste is recyclable and the normal biodegrading process of plastic might take up to 700 years. In addition, the quality of recycled plastic products is not as good as recycled glass and paper products.

This research examines the use of recycled plastic garbage as a component of wall building (not a load bearing wall). Moreover, this research aims to discover improvements to the insulating properties of a cement block. Insulation is needed because exterior walls are exposed directly to the heat of the sun, especially walls of buildings in tropical countries.

2. LITERATURE REVIEW

2.1 General characteristics of PET

Most plastic containers are made from type 1 plastic or PET (polyethylene terephthalate). PET is a tough transparent plastic with the ability to endure humidity, light, and heat. The temperature endurance of this type of plastic is between -40°C and 54°C. The average temperature in Thailand never exceeds 50°. The density of PET plastic is between 15 and 60 kg/m³ when the temperature is extremely high and the thermal conduction is 0.24 W/mK.

2.2 Design concept of a plastic block which acts as a thermal conductor

PET plastic is one of the best materials that can be used as an insulator. Mansour & Ali (2015) did a comparative experiment with a concrete block that contained nine plastic bottles. Four experiments were conducted for a comparative analysis – 1) a concrete block contained bottles filled with dry sand 2) a concrete block contained bottles filled with wet sand 3) a concrete block contained empty bottles 4) a hollow-core concrete block.

The experimental results showed that the concrete block that contained empty bottles was the best heat insulator (with a thermal resistance of 18.9 °C/W) followed by the concrete block that contained bottles with dry sand. The research results correlated with a study by Cengel (2006) where he evaluated the heat conduction ability (K-value) of different types of material; air = 0.027 W/mK, dry sand = 0.27 W/mK, wet sand = 2.00 W/mK and cement = 0.72. Heat conduction ability (K-value) is the reverse variation with the heat insulator value.

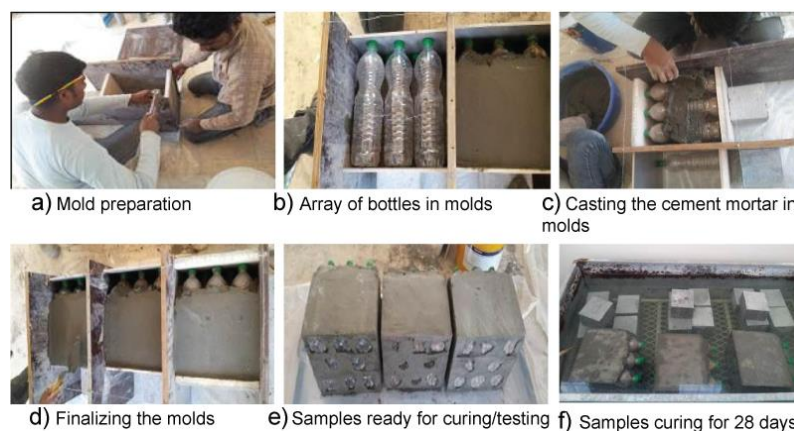

Figure 1: Illustrates the preparation process of concrete blocks which contain plastic bottles
source: Mansour & A, Ali (2015)

Kamal & Rizvi (2008) conducted an experiment to test the design of a ‘sandwich panel’ wall using PET plastic bottles which were inserted between the void of the two panels. Wire mesh was used to hold the empty bottles in place, and plaster and mortar were used as a matrix material. In this experiment, empty bottles -inserted between two panels- act as an air space. The air space reduced the heat transfer between the wall panels.

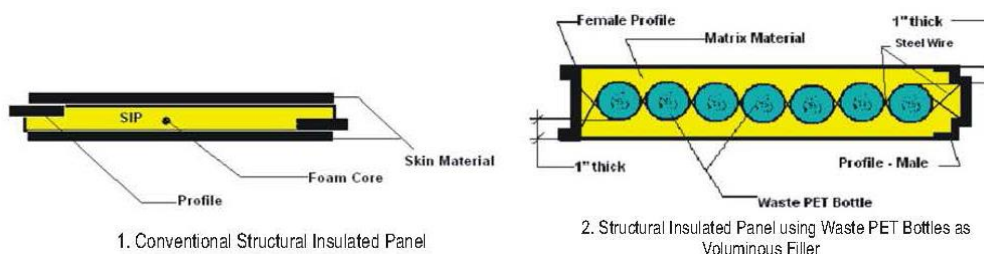

Figure 2: Comparative experiment between normal concrete panel and sandwich panel wall
source: Kamal & Rizvi (2008)

Safinia & Alkalbani (2016) studied the design of a concrete block that contained 500 ml PET plastic bottles. The 200x400x200 mm concrete block contained eight plastic bottles which were attached to the block with wire. The ‘bottle-blocks’ were pressure tested and the results were compared to pressure tests that used a hollow core concrete block. The results showed

that the block that contained empty PET plastic bottles endured higher pressure than a hollow core concrete block. The amount of force that a concrete block with PET bottles can endure (9.9 MPa) is triple the amount of force that a hollow core block can endure (3.64 MPa).

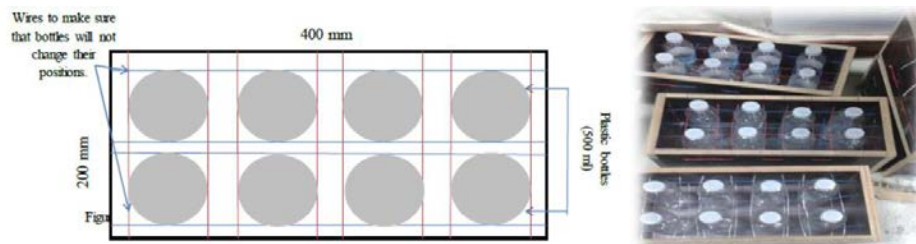

Figure 3: Illustrates a concrete block that contained PET plastic bottles
source: Safinia & Alkabani (2016)

Nienhuys (2004) studied the design of a cavity wall that had been filled with empty PET and HDPE plastic bottles. Plastic bottles were put in a PP (Polypropylene) garbage bag and then inserted between the two wall panels. The results showed that a PP garbage bag helped reduce the heat transfer from the inside to the outside of the building. The result was that the room stayed warm throughout the night due to the slower heat transfer which suits the cold temperatures of winter in Nepal.

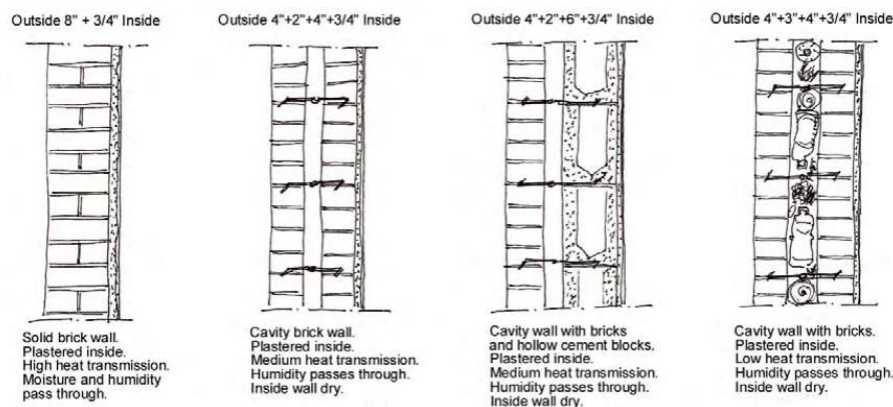

Figure 4: Wall panels (far right) which contained PET and HDPE plastic bottles compare to normal wall panel and a two layer wall panel
source: Nienhuys (2004)

Most of the experimental results showed that it is not necessary to transform plastic bottles into plastic flakes. Empty PET plastic bottle can be used although the bottle contains air. The air acts as a heat insulator and reduces the heat transfer. Plastic bottles containing other materials such as sand or water do not increase the level of heat insulation (Mansour & A.Ali, 2015). Moreover, plastic bottles can easily decrease the weight of the concrete block and increase insulation capacity.

Concrete blocks which consist of plastic bottles share similar characteristics to autoclaved concrete masonry units. Thus plastic bottles can be used as one of the main materials in order to produce autoclaved concrete masonry units (Safinia & Alkabani, 2016). The unit is a combination of cement, sand, and water. The size of the block needs to be large enough to

contain plastic bottles. However, the blocks are usually produced in small units which are similar to autoclaved blocks. The block can then be used to build walls.

3. RESEARCH DESIGN

3.1 The design of a concrete block

The block was designed as a small rectangular module due to the practicality of construction and convenience of transport. Moreover, the concrete block should be easy to produce on mass. The block consists of a mixture of cement, sand, and water. The plastic bottle will be placed in the middle of the block. The degree of heat insulation was the main aspect influencing the combination of the block materials (cement, sand, water).

This research aims to create guidelines for the production of a high insulation concrete block for the construction of a house in Thailand. The production of the concrete does not require any industrial setting. Therefore, moisture contained in the materials was excluded during the variable analysis process. However, each concrete block contains the same type and proportion of materials. The plastic bottles were produced by the same manufacturer with similar date and time. The only difference was the size of the bottles.

3.1.1 PET plastic bottle size and the size of concrete block

The most popular plastic bottles available in the Thai market are 400, 600, 700, 1000, and 1500 ml. However, the most practical and convenient size of concrete block for building walls is 300x100x100 mm.

The block should not be too wide because a wide concrete block will create difficulty while constructing walls. Moreover, a large plastic bottle will lessen the amount of concrete and create a weak wall. Therefore, only 400 to 1000 ml bottles should be used in the block. A 1000 ml bottle with 8 cm diameter and 23 cm height was used to test the strength and insulation properties of a block.

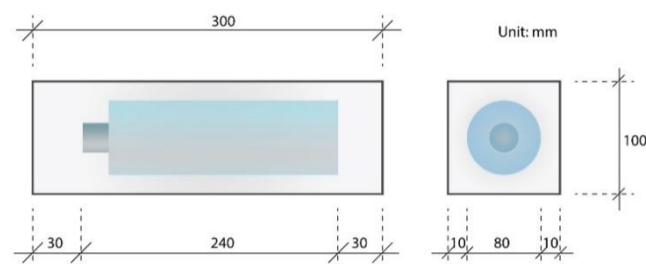

Figure 5: Concrete block which contain a 600 ml plastic bottle

3.1.2 Combination of concrete mixture

The concrete block contains: sand, water, and cement. A perfect ratio between **cement and sand is 1:2**. If the ratio is too high the concrete will be too brittle and weak and if the ratio is too low the concrete will also be too weak. **The ratio between cement and water is $w/c = 0.5$** .

If the amount of water is decreased the density of the concrete increases and it is difficult for the plastic bottle to float in the mid-point of the block.

3.2 Wall design and experiment of the sample wall panel

3.2.1 Air volume and concrete density

The results from related studies show that the air volume correlates with the ability of the concrete block to transfer heat. However, air volume and concrete volume have an inverse ratio. Therefore, the **ratio between air volume and concrete volume** is the main criteria used to design sample wall panels for the research experiment. Wall panels with different ratios of air to concrete were constructed and used in the empirical experiment. The experiment focused on the strength of the wall and the capacity of heat insulation.

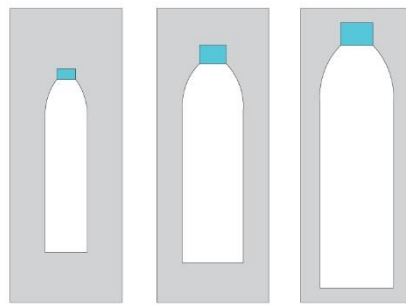

Figure 6: Design concept of concrete block with different densities from low air volume-high concrete volume/ high air volume – low concrete volume

The 300 x 100 x 100 mm (length x width x height) concrete block is the most common block size used in wall panel construction. The plastic bottles used were 400, 700, and 1000 ml. Each bottle has 300 ml air volume difference.

3.2.2 Types of concrete block used in the experiment

In total there are four types of block used in the experiment. Three blocks contain one bottle of 400 ml (S), 700 ml (M), and 1000 ml (L) respectively, and one block is a normal autoclaved concrete block. List of concrete block display in table 1.

Table 1: List of concrete block used in the experiment and the comparison between air volume and concrete volume

Block (ID)	Bottle size (ml)	Bottle diameter(\varnothing) and height(h) (cm)	Overall volume (ml)	Air volume (ml)	Concrete volume (ml)	Ratio between volume and air(%)
R-00	none	-	3,000	0	3,000	0
P-04	S - 400	(\varnothing)= 6.11 \pm 0.2 cm (h)= 21.25 \pm 0.2 cm	3,000	405	2595	13.5
P-07	M - 700	(\varnothing)= 6.83 \pm 0.2 cm (h)= 26.35 \pm 0.2 cm	3,000	709	2291	23.2
P-10	L - 1000	(\varnothing)= 7.52 \pm 0.2 cm	3,000	1011	1989	33.7

		$(h) = 26.50 \pm 0.2 \text{ cm}$				
--	--	----------------------------------	--	--	--	--

4. METHODOLOGY

4.1 Apparatus – format and installation of heat transfer efficiency tester

A Heat Flow experiment was conducted to evaluate heat transfer and the efficiency of the insulators. In this instance heat is transferred from a high temperature area (outside the building) to a low temperature area (inside the building). The experiment conducted was based on the ASTM 518 standard (steady state thermal transmission properties) heat-flow method. The ASTM 518 standard was adapted to fit with the temperature set for the experiment, the duration of the experiment, the defined factors, and budget limitations.

A box of 60 x 60 cm was designed and used as a heat evaluation instrument. One side of the box was attached to a concrete block and the other five sides including top and bottom were attached to polystyrene foam. There are four boxes; each box contained R-00, P-04, P-07, and P-10 block.

The experiments were conducted several times. Boxes were installed around the heat source. One side of a foam box was attached to the concrete unit face. The four blocks with attached foam boxes were placed around the heat source to form a quadrangle (figure 7). The experiment used a 25 Watt incandescent lamp which provided a stable heat output, with a standard power of 220 Volt. Thermocouples were installed in the middle of the box in order to measure the temperature in each box (point D). Another thermal couple was installed at the bottom of the box to measure the heat dissipation (point A). A data logger was used to collect data every 10 minutes from all thermocouples. The experiment was evaluated using data analysis.

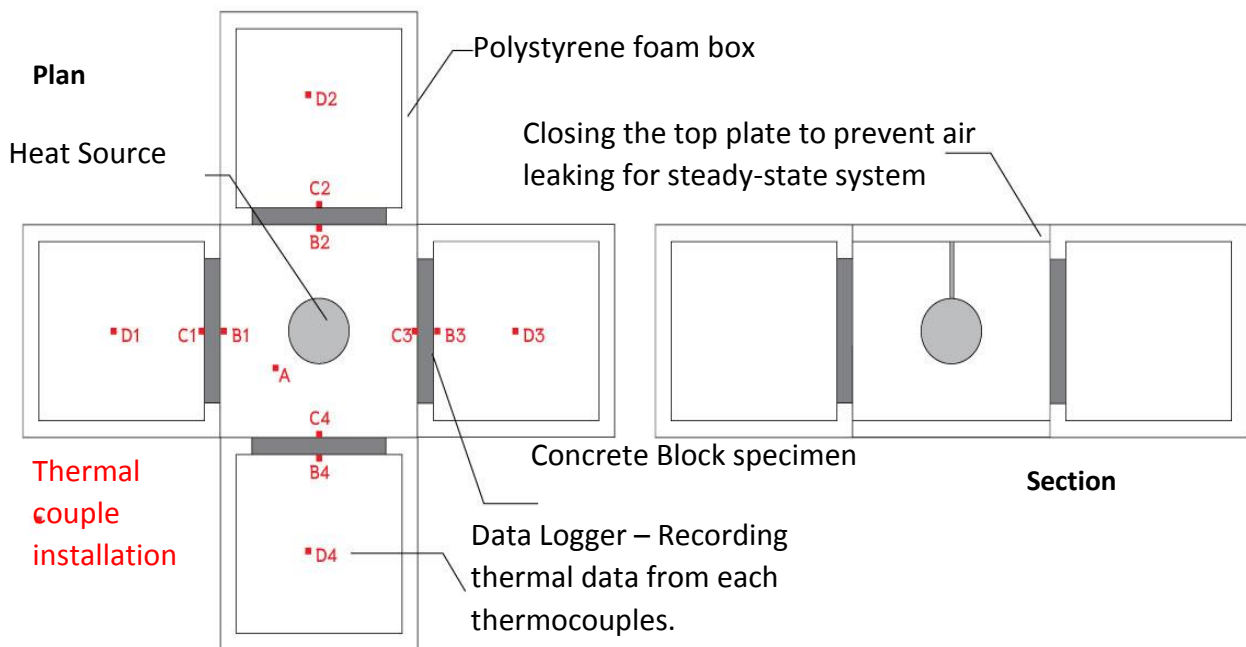

Figure 7: Displays heat and insulator measurement equipment

The experiment was divided into two sessions (1) endothermic session (1- 19 hours) and (2) exothermic session (20 – 24 hours). The analysis of the resistance of the material focuses on the comparative between the sample box and each individual concrete block that contains a PT plastic bottle. The data calculation aims to find the temperature difference between the sample box and each concrete block. The study's intent was to find the concrete block with a PT bottle that has a better ability to transfer and resist heat. Therefore, the thermal resistance has not been calculated during the analysis. The researchers would like to produce a production guideline that can be easily followed by a normal household in the rural areas of the country.

5. RESEARCH RESULT

5.1 Results of heat transfer

There are two parts of the experiment regarding the heat transfer ability of the sample box. The data collected in both parts was analysed as follows:

- 1) A comparison of the average temperature inside each sample box
- 2) A comparison between the interior and exterior temperatures of the sample boxes

There are two parts of the analysis: the endothermic session and exothermic session. Data was displayed in a line graph showing the average temperature each hour. The experiment was divided into two sessions (1) endothermic session (1- 19 hours) and (2) exothermic session (20 – 24 hours).

5.1.1 Result of the ratio between air volume and concrete volume

A comparison was made between the air volumes of each size of PET plastic bottle in order to discover which size of bottle would perform as the best insulator.

1) Comparison of the average temperature inside each sample box

For the first seven hours the interior temperature of the box increased slowly, but after the eighth-hour the interior temperature of each block started to increase at different rates. Sample box P-10 had the best ability to transfer heat, the box had the lowest average temperature followed by box P-07 and box P-04 while the reference box (box R-00) had the highest average temperature (figure 8).

2) The comparison between interior and exterior temperature of the sample box

The sample box which contained a concrete block with a bigger PET plastic bottle had a far greater temperature difference compared to a box that contained a smaller PET plastic bottle. During the endothermic session the sample box stabilized the interior temperature while the exterior temperature rose dramatically while during the exothermic session the box transferred the heat much faster compared to a block without the PET bottle. Sample box P-10 is the best heat insulator followed by box P-07, P-04, and R-00. Nonetheless, all the concrete blocks with PET bottles behaved similarly during the endothermic session whilst the concrete block without the PET bottle absorbed the heat rapidly and transferred the heat very slowly (figure 9).

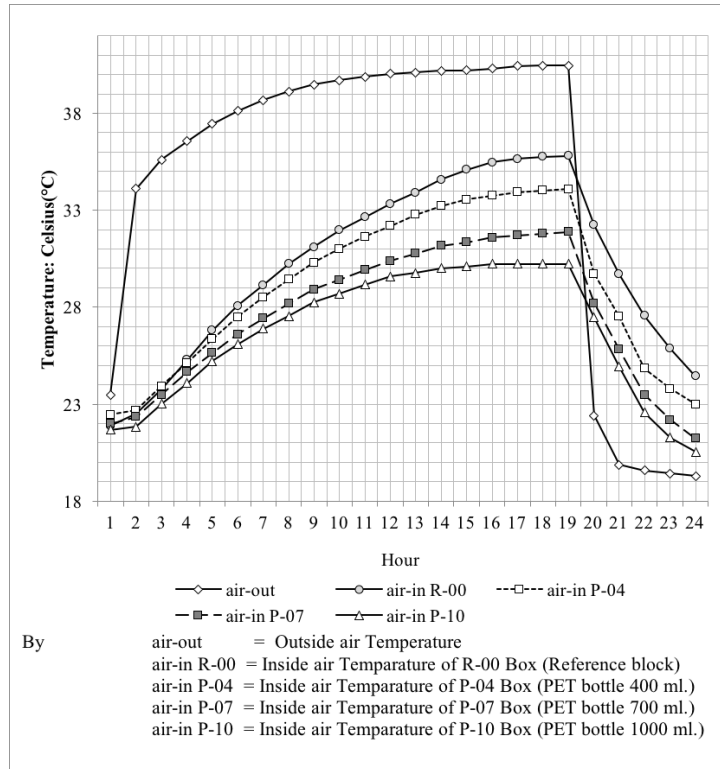

Figure 8: Line graph compares the interior temperature of each sample box

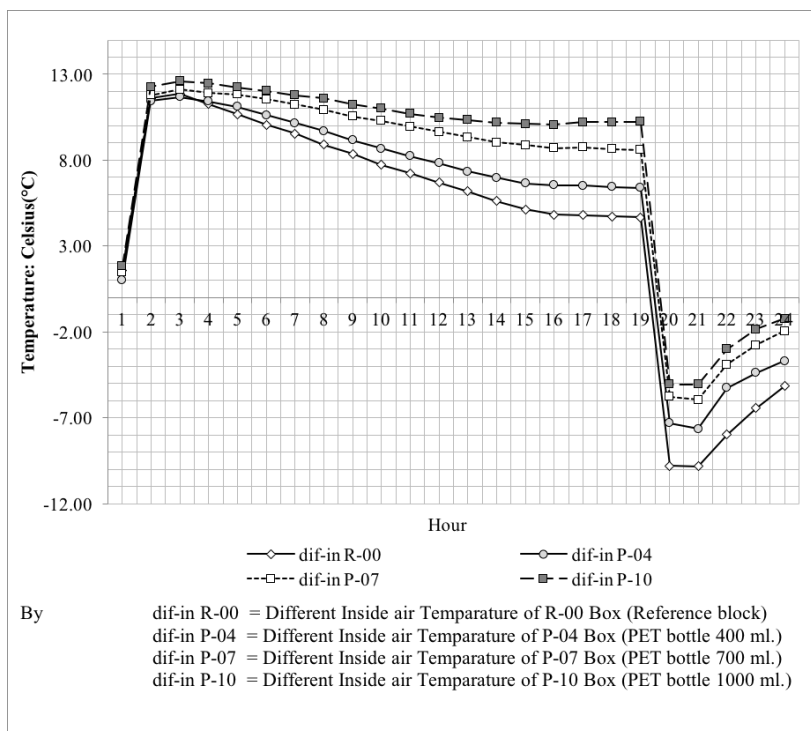

Figure 9: Line graph compares the difference of exterior and interior temperature

5.3.1 The analysis of the concrete block with PET plastic bottle

A concrete block that contains PET plastic bottles are better insulators compared to an autoclaved concrete (reference box). The average interior temperature of all the boxes is 3-10% lower than the interior temperature of the reference box. The maximum interior temperature of all the boxes is 5-16% lower than the reference box. These data correlate to the heat transfer theory of the high density materials and insulator materials. The air contained in the plastic bottle acts as an insulator. The heat, therefore, cannot transfer rapidly inside the block and this causes the much lower interior temperature compared to exterior temperature.

When the air value is increased in the sample box P-10 it has the ability to slow down the heat transfer but not as much as in box P-04 or when the air volume is increased in box P-07. This may be caused by the increase in the density of the concrete. The concrete volume has an impact on the heat transfer as concrete slows down the exothermic properties of the block. Thus, the interior temperature of the high volume concrete does not act as a good insulator. To conclude, box P-10 is the best insulator.

Table 2: The comparison between the air density and the ability to transfer heat

Sample box	R-00	P-04	P-07	P-10
Air ratio(%)	0	13.5	23.2	33.7
Average interior temperature	27.96	25.78	24.18	23.36
Average interior temperature that decreases when compared to box R-00		2.18 (8%)	3.77 (13%)	4.60 (16%)
The difference of the average interior temperature when compared to exterior temperature	7.84 (39%)	5.66 (28%)	4.07 (20%)	3.24 (16%)
The maximum interior temperature	29.69	27.52	25.82	24.93
The maximum interior temperature when compared to box R-00		2.17 (7%)	3.87 (14%)	4.76 (16%)
The difference of maximum interior temperature when compare to exterior temperature	9.82 (49%)	7.65 (39%)	5.95 (30%)	5.06 (25%)
Average interior and exterior temperature difference	7.84	5.66	4.07	3.24

Regarding the exothermic session, a sample box which contains the bigger PET bottle acts as a better insulator; temperatures of box P-04, P-07, and P-10 rapidly decreased when compared to the reference boxes at 8, 13, and 16%. The difference between the maximum interior and exterior temperature is less when compared to the box R-00 at 39, 20, and 25%.

According to the data collected from both endothermic and exothermic sessions, **sample box P-10 is the best insulator followed by box P-07, and P-04.** The analysis results correlated with research by Mansour & Ali, 2015. Another conclusion found in this experiment is that;

air has a low thermal conductivity and high volumes of air increases the insulating ability in the building walls (Cengel, 2006).

The ratio between air volume and concrete volume is one of the important criteria that should be considered when measuring the concrete block. If the air volume is too low the concrete block will not act as a good insulator. For example the temperature in box P-04 is similar to the box R-00. On the other hand, if the air volume is too high the ability of the heat transfer will decrease such as in box P-10. The experiments were conducted with the temperature that is similar to the outdoor temperature in Thailand. The aim of the study focused on the recycling of plastic bottle waste and designing a concrete block that can be used as a component of wall construction. Moreover, the block should be able to decrease the temperature rapidly and act as a good heat insulator. Therefore, **box P-07 (containing 700 ml PET bottle) and P-10 (containing 1000 ml PET bottle)** are the suitable concrete blocks that can be used as wall materials.

5. CONCLUSION

5.1 General conclusion from the reuse of PET bottle

A PET plastic bottle is a suitable building component that can be used as a thermal insulator. Additionally it is a feasible method of construction in a rural area with limited resources and demonstrates another use of plastic bottles in the recycle and reuse industry. These research results show that the air volume in a plastic bottle slows down the heat transfer process. Thus, the interior temperature of a house is cooler with walls constructed of blocks containing plastic bottles.

The air in a PET plastic bottle has a low thermal conductivity compared to a high thermal mass concrete block which increases heat transfer. Therefore, this creates a far greater difference between exterior and interior temperatures. During the endothermic session the interior temperature of the box cools down rapidly while during the exothermic session it is due to the high air volume of the plastic bottle. Therefore, PET bottle size 1000 ml has the highest efficiency followed by bottle size 700 and 400 ml respectively.

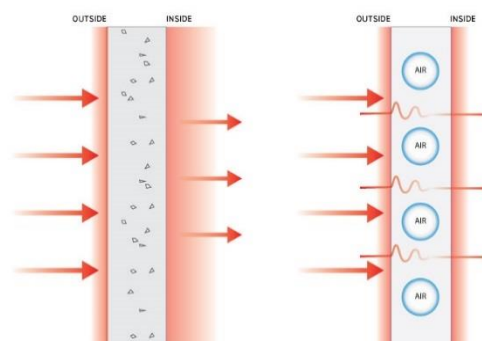

Figure 10: Illustrates heat transfer process of the R-00 block (left) and heat transfer of concrete block with PET bottle (right)

5.2 Guideline of using the concrete block in the construction process

The smallest unit bottle-block is 300x 100x 100 mm (length x width x height) and contains one 1000 ml bottle. The size of the block can be expanded to accommodate more bottles. For example a 600 x 200 x 100 mm block can contain four PET bottles. The concrete-bottle block can be used in a normal masonry wall construction.

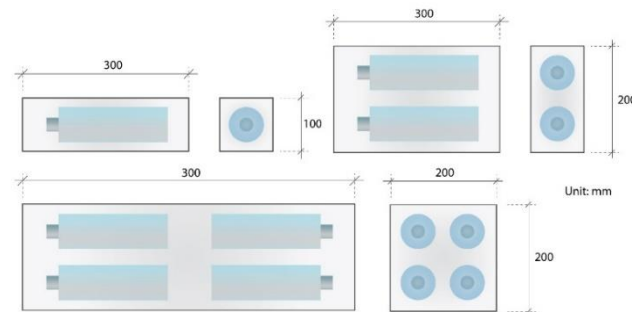

Figure 11: The block can be designed in different sizes depending on the wall construction

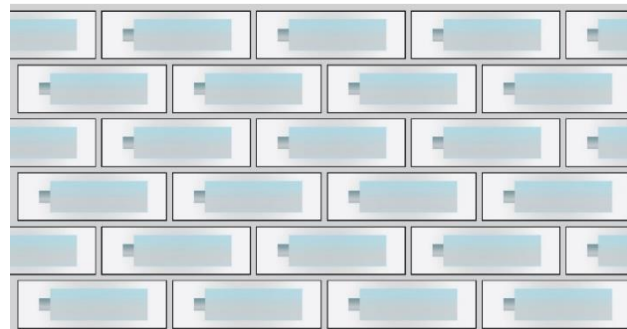

Figure 12: The blocks were laid horizontally but not aligned

The concrete-bottle block can be used in the process of normal wall construction; using sand and cement the same as a normal concrete block. There is no visible difference especially when the wall has been rendered.

6. REFERENCES

- Cengel, Y. A. (2006). Heat and Mass Transfer 3rd Edition. New York: McGraw Hill.
- Cox, P. M., Betts, R. A., Jones, C. D., Spal, S. A., & Totterdell, I. J. (2000, November 9). Acceleration of global warming due to carbon-cycle feedbacks in a *coupled* climate mode. *Macmillan Magazine*, pp. 184-187.
- Pollution Control Department. (2002). The report on Thailand pollution 2003. Bangkok: Ministry of Natural Resources and Environment.
- Mansour, A., Mansour, H., & Ali, S. A. (2015). Reusing waste plastic bottles as an alternative sustainable building material. *Energy for Sustainable Development* 24, 79-85.
- Kamal, M. A., & Rizvi, S. J. (2008). The Recycling of Waste Pet Bottles as a Low Cost Alternative Composite Material. *International Journal on Design and Manufacturing Technologies*, Vol.2, No.1, 79-81.
- Nienhuys, S. (2004). Plastic Waste Insulation Re-Use of PET for High Altitude Houses. Kathmandu, Nepal: SjoerdNienhuys.
- Safinia, S., & Alkalbani, A. (2016). Use of Recycled Plastic Water Bottles in Concrete Blocks. *Procedia Engineering*, 214-221.

MAPS LED

SMART SPECIALISATION STRATEGY: THE TERRITORIAL DIMENSION OF RESEARCH AND INNOVATION REGIONAL POLICIES

C. Bevilacqua¹, V. Provenzano², P. Pizzimenti¹ and Carla Maione¹

¹PAU Department, CLUDsLab, Università Mediterranea, Via Melissari, Reggio Calabria, 89124, Italy

²Università degli Studi of Palermo, Piazza Marina, 61, Palermo 90133, Italy

Email: c.bevilac@unirc.it

Abstract. The paper aims at investigating how EU Regions should incorporate the place-based approach (Barca, 2009) to plan their Research and Innovation Smart Specialisation Strategy (RIS3) within the current Programming Period 2014-2020. Smart Specialisation Strategies become a key factor to stimulate private investment, and “should be integrated into regional development strategies in order to ensure an effective partnership between civil society, businesses and public authorities at regional, national and European levels” (EC, 2010). The link envisaged between S3 and place-based approach is based on their characterization of a development policy, and on the value of the different geographical, social, economic features that territories can express (Foray, 2000). The transformation of these two theoretical approaches into policy is recognizable in two drivers for programming the Agenda 2020. The first is the Theory of Change, which implies the use of “indicators” related to the value that different territories can express to control and measure the expected change. The second is more related to stimulate at regional level an integrated approach to reach a critical mass of the investment effects/impacts. The MAPS-LED Research Project (Horizon2020) perspective is described as a way to investigate how is possible to regenerate local economic areas through S3 considering place-based approach.

Keywords: MAPS-LED, RIS3, S3, Territorial Dimension

1. INTRODUCTION

The aim of this paper is to highlight how European Regions have incorporated the Place-based approach to plan their Research and Innovation Smart Specialisation Strategy (RIS3) within the current Programming Period 2014-2020 taking into account the “territorial dimension”. The European Union is trying to come out of the recent and severe economic crisis that caused serious socio-economic consequences at the macro and micro level. Measures set by the European Commission have been inspired by the so-called “austerity principles”, pushing the academic and political debate towards the impacts and the effectiveness of regional development policies. National and Regional governments are called to set up innovative solutions in order to boost economic growth and development aiming at empower Cohesion Policy and reduce disparities among European regions. The interest generated by the debate has highlighted the special role that the regional governments play in pushing development towards innovation, being more aware that no change is possible without choices relevant for the context. In this sense a “new” approach based on Smart Specialisation Strategies (S3) drives toward this direction, no more a perspective designed within the Operational Programmes just in responding to the general requirement of European Commission. This approach could represent an interesting way to reach the goal of “Territorial Cohesion” by overcoming the conflict that a European strategy could generate in the implementation of territorial transformations, due to the place dimension of Public-Private investment allocated within Operational Programmes of Structural Funds. The first part of the paper is focused on the territorial dimension of European Policies starting from the introduction of the European

Spatial Development Perspective (ESDP, 1999) and the Place-based concept (2009). Since the 1980s the territorial dimension has been taken into account by the European Union and, from the 1990s, the “spatial approach” came to the light thanks to the ESDP and its “polycentric” view for the spatial development of European Regions. The second part is focused on the Smart Specialisation’s concept introduced by Foray (2009) and the place-based approach introduced by Barca (2009), which became the paradigm of the Cohesion Policy. S3 represent a turning point for the European Cohesion Policy. The increased attention toward regional “specialisations” not just for the regional dimension, as in the past, but toward the external dimension, represents a key point in mitigating negative economic effects deriving from globalisation processes. It is arguable that territorial dimension is crucial in RIS3 plans implementation. The third part of the paper is focused on the implementation of National and Regional RIS3 Plans, introducing the MAPS-LED Research Project (Horizon 2020–MSCA Actions-RISE) perspective as a way to investigate how is possible to regenerate local economic areas through Smart Specialisation Strategies taking into account place-based approach.

2. TERRITORIAL DIMENSION AND COHESION POLICY: FROM POLYCENTRISM TO PLACE-BASED APPROACH

Since the 1980s, the main aim of the Cohesion Policy has been to strengthen the economic and social cohesion in order to reduce disparities between more developed and underdeveloped regions. Although the term “territorial” is not the main word emerging from the Cohesion concept, it is (and it was) embedded and implicit and it is crucial in order to reduce the disparities (also territorial not only socio-economic) among European regions (it was included in EC Treaty in 1997, art. 3 of TEU and art. 2 of TFEU). Territorial Cohesion principle is about ensuring the harmonious development of all these places and about making sure that their citizens are able to make the most of inherent features of these territories (EC, 2008). As stressed by D. Hübn r (Böhme et al 2011), “it is a fundamental objective of regional planning in the Union and provides the *raison d’être* for regional development policy”. The European Union is characterised by a huge territorial diversity among regions that makes necessary the inclusion of territorial aspects in implementing European Policies. “Territorial Cohesion, if taken seriously and on condition that is given a broader interpretation than simply the provision of services of general economic interest, will feed into existing EU Policies by adding a territorial dimension to them, thereby making them more effective and efficient” (Zonneveld and Waterhout, 2005 quoted in Waterhout 2008: 83). According with Waterhout (2008) when referring to policies it is more appropriate to use the term “spatial” rather than “territorial” assuming that “territory refers to socially constructed places, whereas spatial refers to less clearly defined areas, which seem to be of a larger scale encompassing territories” (Waterhout 2008: 14). This conceptual issue has been the core of the scientific debate that have brought to consider the spatial dimension in EU policies and to take into account the spatial impacts of their implementation. In 1999, thanks to the European Spatial Development Perspective (ESDP), European Union Members States defined the relevance of the spatial dimension in order to achieve a more balanced and sustainable development of the European Territory. “Polycentric development is the only substantive spatial planning concept in the European Spatial Development Perspective (ESDP) with the potential to integrate the interests of the many parties involved” (Waterhout 2008: 56). The ESDP Document represented the attempt to put spatial planning on the European policy map (Waterhout 2008). One of the main issues that is animating the current debate (see Faludi 2015) is represented by the deep differences among European Member States, which go beyond the simple territorial characteristics of each European Regions. In 2007 the Territorial Agenda of the European Union (Towards a more

competitive and Sustainable Europe of Diverse Region) confirmed the will to “promote a polycentric territorial development of EU” aiming at the territorial integration and securing a better quality of life with respect of the regional and local potentials. The EU Cohesion Policy has to take into account the territorial needs and characteristics in responding more effectively to the specific geographical challenges and opportunities of the regions and cities (Territorial Agenda of the Union 2007). The Territorial Agenda (2007) was integrated by the Leipzig Charter on Sustainable European Cities, which highlighted the relevance of the urban dimension and the need of an integrated urban development policy, making possible the integration between (urban) development policy and territorial cohesion policy in order to achieve a sustainable development. As defined in the Leipzig Charter (2007) the integrated urban development policy is a process in which the spatial, sectorial and temporal aspects of key areas of urban policy are coordinated. In this perspective cities acquired a central role. They have been assumed as “parts of a polycentric pattern to ensure their added value for other cities in rural and peripheral areas” (Territorial Agenda of the Union 2007). Cities and regions then, arise as key elements for a long-term sustainable development. This new approach has paid attention to crucial cities’ issues of the last decades: the need to ensure high-quality public spaces, the need to modernise the infrastructure networks, innovative educational policies, set up new strategies for upgrading the physical environment, strengthen local economy and labour market policy, efficient and affordable urban transportation. Integrated Urban Development is not just an urban policy focused on spatial planning declined by each member state according with its own administrative structure, it is a policy opened to the integration with other European policies and Funds. The introduction of the Europe 2020 strategy in 2010, which can be seen as the general Road Map of EU policy targets within this decade (Schmitt, 2011), contributed to the review of the Territorial Agenda drawn up in 2007. The first part reinforces the relevance of the Territorial Cohesion for the Union because “it enables equal opportunities for citizens and enterprises, wherever they are located, to make the most of their territorial potentials” (Territorial Agenda 2020: 4). Since the end of the 1980s, urban dimension has been taken into account in the European Structural Funds as a result of the recognition of cities’ role in economic growth and competitiveness (Atkinson, 2014). During the middle of 1990s, the European Commission launched the URBAN Programme, an initiative of the European Regional Development Fund (ERDF) to achieve sustainable development in distressed urban districts, characterised by socio-economic and environmental decay. During the programming period 2000-2006, within the second part of the URBAN II programme, was introduced the URBACT network, which main aim was to support and continue the exchange of information on sustainable urban development across Europe. In 2007-2013 programming period, the ERDF included a “stronger urban element” (Atkison, 2014: 4), providing through the integration of Structural Funds (European Social Fund and Cohesion Fund) a range of initiatives to implement urban development projects (one of the recommendations of the Leipzig Charter was to “coordinate and spatially focus the use of funds by public and private sectors players”). Thanks to the cooperation with The European Central Bank (ECB), the European Commission developed a set of financial engineering mechanisms aiming at contributing to the implementation of the integrated urban development approaches and strategies. This is the case of the JESSICA (Joint European Support for Sustainable Investment in City Areas) and JEREMIE Funds (Joint European Resources for Micro to medium Enterprises), two financial instruments set by the European Central Bank (ECB) and European Commission for leveraging private capitals into the implementation of integrated urban development strategies (Liepzig Charter, 2007). Along this overview on the territorial dimension in implementing EU Policies two main key aspects arise: the “territorial potentials” and the “equal opportunities” principles that represent the basis of the Place-based approach introduced by Barca (2009), considered the core of the European regional development policy

for the programming period 2014-2020 together with the concept of Smart Specialisation Strategy. This new “regional-economic thinking”, as defined by Faludi (2015), is a new paradigm emerged thanks to the Barca Report (2009) that highlight the importance of local contexts on grounds of both efficiency and equity (Faludi 2015). The need to rethink economic development strategies, both on national and regional/local level, remarks the importance of factors “such as human capital and innovation (endogenous growth theory), agglomeration and distance (new economic geography), and institutions (institutional economics) (Barca et al. 2012: 136). These factors are the results of a period of radical political, institutional and economic change started in the late 1980s that brought to the revision of regional economic development policies. Within this context “innovation” acquired an increasing importance as a cross-cutting process able to empower the potentials of places in achieving a more balanced and sustainable development.

3. THE INTRODUCTION OF SMART SPECIALISATION STRATEGY AS POLICY PARADIGM: FROM A THEORETICAL CONCEPT TO EUROPEAN POLICY

The introduction of the concept can be dated back to the European Council of Lisbon (2000) where the European Union set the clear objective to develop a knowledge-based economy. Thanks to the “Knowledge for Growth Group”, in 2009 the “Smart Specialisation Concept” came out (Foray et al. 2009, 2011). According with Dominique Foray (2015), smart specialisation concerns “the capacity of an economic system (a region for example) to generate new specialities through the discovery of new domains of opportunity and the local concentration and agglomeration of resources and competences in these domains”. The original smart specialisation concept was mainly focused to elements aiming at maximise the economic potential in filling the transatlantic productivity gap through the valorisation of entrepreneurial actions (McCann, 2015). Indeed, the core of the “Smart Specialisation” concept is represented by the “entrepreneurial discovery” that can be considered a sort of pre-condition in materialising innovation. Foray (2009) defines it as an essential phase, the crucial link for reorienting and renewing a system. Thus, the entrepreneurial discovery phase is crucial for several factors: first of all, a policy based on the entrepreneurial discovery process as priorities identification is not a policy that says “what to do” but “how to do”, underlying the relevance of the process than the product. The entrepreneurial discoveries effects can be maximised if considered in the potential policy actions (Foray, 2009). Thanks to these information, governments have to choose new activities according with their potential impacts, feasibility, proximity to market, relevance for the regional economy, number of actors involved etc. In the S3 process, sectors are not a key area of intervention. Relevant action relates to activities that enable being aware of regional knowledge economy that can be considered as basis for S3. National and regional authorities across Europe shall design smart specialisation strategies starting from entrepreneurial discovery process in order to use more efficiently European Structural Investment Funds (ESIF), activate synergies among EU, national and regional policies and increase public and private investments (EU, 2012). If we consider the theoretical background of S3 (Foray, 2000), the link envisaged between S3 and place-based approach is based on their characterization of a development policy, and on the value of the different geographical, social, economic features that each territory can express. However, Europe still presents deep differences: regions more competitive and able to compete in the globalised market and regions with unsolved structural weaknesses, highlighting an “innovation gap” among them. Funds need to be coordinated and integrated with other European tools in supporting innovation and research, particularly the Community Innovation Program (CIP) and Horizon 2020 Programme (The European Research Program for the period 2014-2020). S3

allow the setting-up of a strategy focused on innovation, giving a valid answer to problems of regions characterised by unemployment and low growth rate. In this perspective, the concept of “strategic intelligence”, i.e. the capability to develop a responsive mode to change complexity, is necessary in selecting high added value activities offering the opportunity to reinforce regions competitiveness. S3 offer the opportunity to link businesses, research centres and universities in order to identify regional specialisation sectors and the hampering factors of this process. The shift of smart specialisation, from concept into policy, came with the new Rules for the European Structural Funds, the Union’s financial tools in achieving European Cohesion Policy. Particularly, Article 2 of the General European Structural Funds Regulation no. 1303/2013 defines the Smart Specialisation Strategy as “national or regional innovation strategies which set priorities in order to build competitive advantage by developing and matching research and innovation own strengths to business needs in order to address emerging opportunities and market developments in a coherent manner, while avoiding duplication and fragmentation of efforts; a smart specialisation strategy may take the form of, or be included in, a national or regional research and innovation (R&I) strategic policy framework” (EU Regulation No. 1303/2013).

3.1 The territorial dimension in research and innovation policies: the RIS3 plans

The European Commission requested to each European region to enlighten in an action plan for RIS3 the regional strategies for the programming period 2014-2020, in order to respond the local demand of innovation and to stimulate new sources for a self steady development. The role of the city together with the horizontal perspective of sustainable urban development, could better drive an effective implementation and adjustment of RIS3 regional plans. The current phase allows outlining the level of completeness, relevance and consistence of the selected actions by each European region to drive economic change through smart specialization strategies/RIS3. National/regional research and innovation strategies for smart specialisation (RIS3) are integrated, place-based economic transformation agendas focused on five key elements (EU, 2012): (i) policy support and investments on key national/regional priorities, challenges and needs for knowledge-based development, including ICT-related measures; (ii) country's/region's strengths, competitive advantages and potential for excellence; (iii) support for technological as well as practice-based innovation and aim to stimulate private sector investment; (iv) stakeholders' involvement and encourage innovation and experimentation; (v) evidence-based and inclusion of sound monitoring and evaluation systems.” (RIS3 Guide 2012). The Barca Report emphasised the need to focus on fewer priorities, to be more transparent, to make sure that programme success is verifiable and to better coordinate place-based policies (Barca, 2009). This step has contributed to transform smart specialisation from a technology and research concept to a place-based concept attuned to regional policy (McCann and Ortega-Argilés, 2013). The Barca report (2009) highlights how regions opted for similar types of innovation priorities, increasing the risk of fragmentation and lack of critical mass, which will prevent regions from developing economies of agglomeration and positive spill-overs. “In order to overcome these problems of fragmentation, mimesis and lack of critical mass, great importance has been given to urging regions to foster new activity sectors or industries, by investing in R&I in a limited number of areas with the greatest strategic potential” (Sörvik and Kleibrink, 2015: 4). In the design and implementation phase of RIS3 process, monitoring and evaluation activities play a central role. In 2011, the S3 Platform was established with the aim to support regions in the preliminary phase of their Smart Specialisation Strategies, particularly for “Research and Innovation Strategies for Smart Specialisation” (RIS3). The Platform has the peer review task of proposed RIS3 and to facilitate

RIS3 knowledge and experiences exchange and is located at the “Institute for Prospective Technological Studies (IPTS) of Seville (ES), one of the European Commissions’ Joint Research Centres. The role of the S3 Platform is to provide information, methodologies, expertise and advice to national and regional policy makers, as well as promote mutual learning, trans-national co-operation and contribute to academic debates around the concept of smart specialisation (S3 Platform, 2015). The platform has set up an evaluation methodology in supporting the construction of regional RIS3 plans and in monitoring those critical factors that represent an obstacle for the plan implementation. This methodology is based on the definition of a relevant set of criteria in order to evaluate the performance of each RIS3 plan elements. It helps to highlight the scientific and methodological appropriateness of the plan, highlighting the peculiarities of the regional context according with the 3 critical factors selected for each step of the process (six steps). The evaluation platform set up by the Seville Platform, in which RIS3 strengths and weaknesses are evident and comparable, allow a better sharing of results in orienting the changes to produce. The Seville Platform, in order to support and address context analysis in the conceptual framework of S3 in regional plans, has developed six tools for the monitoring activity: the EYE@RIS3, the ESIF viewer, the ICT monitoring, the Regional Benchmarking, the EU Trade, the R&I Regional Viewer. These tools help in monitoring the adopted RIS3 of European Regions and the outcome they will produce thanks to specific databases. Particularly, the Regional Benchmarking database aims at identifying the regions’ positioning in the European regional context. This positioning is explained through the “distance index” for each European region with the aim to capture structural similarities in the European context and to guide RIS3 tools toward the so-called competitive advantages. The methodology to obtain the synthetic index has been elaborated by the JRC Technical Support and is reported in the S3 working paper series no. 03/2014 “Regional Benchmarking in the smart specialisation process: Identification of reference regions based on structural similarity” (Navarro et al. 2014). It is arguable, observing that the theoretical basis has shifted from benchmarking to performance analysis, for selecting those factors able to give a picture of how competitive advantage is perceived or boosted in the global market. Contemporary, the inclusion of structural context variables is having a central role in support policy decision in the difficult linkage between innovation systems and local economic development. Despite the relevance of monitoring and evaluation activities for S3 implementation, during the last two years the academic and policy-makers debate was characterised by pro-contra positions. The pro arguments start from the conception of S3 as a territorial strategy going beyond policy. Monitoring and evaluation should focus on the capability of a region to achieve its goals and to monitor and evaluate the policy-mix, not individual policies (S3 Platform, 2015). The contra arguments address the importance of the process of monitoring itself, focusing on the role played by regions, the approaches to monitoring and the importance of traditional rigorous monitoring techniques, “given the experimental, entrepreneurial and innovative nature of smart specialisation” (S3 Platform, 2015). In both cases the entrepreneurial discovery process plays a central role, because it will shape the regional system through priority identification and setting (market processes are central in producing the information about the domains for future priorities) (S3 Platform, 2017). The analysis of the Fraunhofer Institute for Systems and Innovation Research ISI (2016) on EDP perception by policy-makers reveals how EDPs are entering in a second phase of discussion characterised by consultation and exchange, rather than concrete decision making. The survey (2016) highlights how, in the majority of cases, the process is led by universities rather than local firms and businesses, with a scarce presence of civil society organisations. The leading role played by universities could affect the expected outcome related to the entrepreneurial discovery process. It could influence the capability of a territory to produce innovation rather than empower and valorise the local specialisations in finding new market

opportunities. In some case, universities are complemented by intermediaries such as clusters, providing a business sector’s perspective thanks to the presence of firms and businesses (ISI, 2016).

4. TERRITORIAL AND SPATIAL DIMENSION IN S3 IMPLEMENTATION: THE MAPS-LED PROJECT PERSPECTIVE

The territorial dimension is a key element of European Cohesion Policy as emerged from the official documents and scientific literature in the field. However, two questions seem to be less investigated within RIS3 plan: the spatial perspective, in physical, economical and social dimension, and the social perspective, in terms of expression of continuously changing behaviours, which sometimes is not captured from the governance structures (MAPS-LED, 2017). Some concerns arose among scholars and practitioners about the real consideration of territorial dimension in RIS3 plans proposed by national and regional authorities. This consideration leads to better understand and investigate the implications of the territorial dimension (intended as the combination of economic, social and spatial factors) dimension of such policy paradigm (see Figure 1).

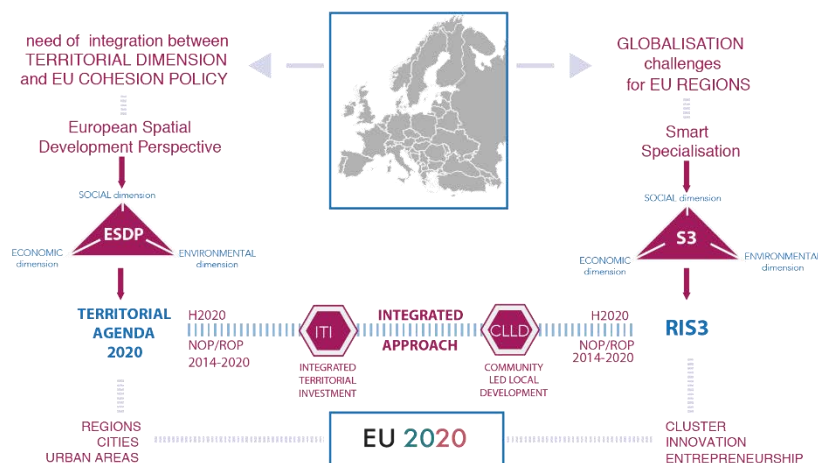

Figure 1. Territorial Dimension and S3. Source: MAPS-LED Project

The MAPS-LED project reflects the progressive attention given to Smart Specialization Strategies (S3) in boosting the implementation of Europe 2020 strategy, at regional and local level. S3 are designed to capture knowledge and innovation dynamics closely connected with characteristics of context. The main challenge is to reverse the current and persistent gap among lagging regions in Europe, which remain at same development stage despite long-term structural funds in research, innovation and technological development. In this sense, contexts conditions, especially in cities located in lagging regions, can significantly affect the implementation of complex policies such as S3 (MAPS-LED, 2017: 12). The joint Exchange programme MAPS-LED is based on a research proposal finalized to examine how smart specialization strategies (S3) to regenerate local economic areas can be implemented, according to the new agenda of Europe 2020. This can be largely achieved by incorporating a place-based dimension. The main objective of the MAPS-LED project is to build and test an evidence-based methodology for recognizing and assessing emerging and potential of S3 in terms of spatial, social and environmental factors. The research project will map out local needs and opportunities in a variety of contexts that could drive regional policy interventions. The resulting S3 will not only emphasize “Key Enable Technologies”, but will also empower the

local innovation process. The MAPS-LED process starts from a place-based framework and will include two important drivers: 1. Cluster policy and cluster-based analysis, 2. Innovative milieu in terms of the local value chains based on the urban-rural linkages. The MAPS-LED project will be built in order to connect three important key-factors including: Governance (in terms of cluster policy and based cluster analysis); Localization (in terms of place-based approach); Territorial network (in terms of innovative milieu based on urban-rural link). The general framework of the research project is organised across four main topics (see Table 1).

Table 1: MAPS-LED Project (Horizon 2020) Main Topics

Topic	Key aspects to investigate
<i>Research and Innovation Strategies</i>	Technology transfer based on "business process"; Business models and partnership research groups and strategic action plan; Entrepreneurship in the research community and social innovation; Clustering entrepreneurial;
<i>Spatial Planning Factors suitable to be mapped in physical terms</i>	Proximity and accessibility (to gateway cities, to infrastructural nodes, to HEI Centres, to broadband facilities...); Spatial pattern ("boundary" of the cluster, network of connections, localisation of place of production and distribution...); Size (dimensional data of the cluster) Critical mass (number of enterprises, size of urban centres involved, number of jobs created....);
<i>Cluster Policy Factors related to the governance systems of the clusters:</i>	Institutional networks, entrepreneurial networks, the global-local nexus between the local area and global systems, the organisation of local value chains, a suitability to be mapped through stakeholder analysis;
<i>Social Innovation Responses to social needs that are developed in order to deliver better social outcomes</i>	(Spatial) identification and GIS mapping of new/ unmet/ inadequately met social needs, related to vulnerable groups.

The originality and innovation in the methodological approach stems from the spatial-led approach to the analysis of US clusters, allowing researchers to draw evidences for a S3 place-based theory testing and implementing pilot S3 areas in European regional contexts. Cluster-based analysis is structured in a spatially oriented logical frame, where the spatial dimension is treated as a combination of the territorial dimension rationale within Cohesion Policy and place-based approach in reforming the Cohesion Policy, both related to Europe 2020 strategy. The cluster based analysis conducted in Boston (case study area) finds its justification in the spatially-led approach to innovation and knowledge dynamics, because cluster includes in its occurrence the specialization process towards innovation. Spatializing cluster acquires the meaning to spatialize innovation, namely, to investigate the nexus between innovation and space/place. The research activities demonstrated that the cluster geographic concentration is characterized by a multi scalar and multivariable geography, in the sense that in each territorial dimension (from state level to city level), clusters provide a conceptual framework to describe and analyse important aspects of modern economies of that territorial dimension. Its role is not to demark a specific area, but to characterize that specific geographic area in terms of innovation, specialization and capacity to activate competitive and comparative advantages (Porter, 1998, 2000; Delgado et al., 2014). Accordingly, the cluster, even with a physical configuration, has been considered as a proxy of innovation concentration because its occurrence is strictly connected (by definition from the Porter's model) to innovation, specialization and job creation (MAPS-LED, 2017b). The research project stages match the implementation of Research and Innovation Strategies for Smart Specialisation (RIS3) regional plans, that are required as ex ante conditionality for Research and Innovation of the current programming period (MAPS-LED, 2017b: 23). The second stage of the MAPS-LED project will take up the final year and will deal with the practice and implementation of the research:

in order to understand the success factors from the US experience on clusters, the selected case studies will be investigated with a view to the S3 concept through an assessment grid based on the above mentioned elements (see table 1), integrated throughout the whole first year research. Multi-criteria approach based on correlation matrix, cluster analysis, hierarchical clustering and Hierarchical Decision Model, and Planning Balance Sheet (PBS) will be applied to analyse, assess and compare: (i) Factors characterizing USA clusters correlated with the EU ones; (ii) Indicators of cluster specialization, spatial factors, organization type; (iii) Success factors with respect to innovation, localization and governance. The data set, ranging from selected data from USA panel information to EU S3 potential data, will be structured in a GIS of Cluster/S3 information system. The proposed methodology under the MAPS-LED project would apply this concept to the wider territorial network and chains, thus allowing to quantitatively assess the potential of the clusters also in social terms and to pave the way to estimate the wider potential of place-based S3 through a two-steps process. The first step aims to develop and test a methodology for Mapping & Assessing Clusters in a place-based and spatial-led perspective. The second step follows the mapping stage and relates to the assessment of the wider impacts of place-based S3, by assessing the clusters' impact in the wider social and environmental perspective, thus leading to discover the extra value generated by the clusters and territorial milieu-nexus.

5. CONCLUSION

Smart Specialisation Strategies represent a turning point for the European Cohesion Policy. The increased attention toward regional “specialisations” not just internal, as in the past, but toward the external dimension represent a key point in mitigating negative economic effects deriving from globalisation processes. Further, the Foray’s perspective, highlights the territorial dimension in terms of “specialisation” of activities that are relevant within a territory (i.e. regional). Regions have to be “aware” of their current assets and their potentials and most of all have to make choices in order to drive the “structural changes”. The contact point between S3 and Territorial dimension seems to occur in 2009 with the publication of the Barca Report, linking the “spatial” issues introducing the place-based approach in contrast with the “spatially-blind” policies. As highlighted by Barca (2009) it is necessary the shift from a “space-blind” to “place-based” approach. This renovated attention to the “place” could reach the overall aim to satisfy efficiency (the capacity of a region to exploit its territorial potential) and equity principles (capacity of each region to provide equal opportunities to their citizens). Although the territorial dimension has always been part of European Policies (at least since 80s and then since 90s in the European Treaties), it was emphasised at the end of 90s with the introduction of ESDP that highlighted the need of “spatial” vision for European territories. In this perspective the territorial dimension become crucial in RIS3 plans implementation. However, two questions seem to be less investigated within RIS3 plan: the spatial perspective, in physical, economical and social dimension, and the social perspective, in terms of expression of continuously changing behaviours, which sometimes is not captured from the governance structures (MAPS-LED, 2017a). RIS3 are in their implementation phase and it is not possible at this moment to establish, clearly, what effects/impacts these strategies will produce in the mid and long terms (MAPS-LED, 2017). The risk of the so-called “me-too effect” is high and this could mean that regions are not taking into account seriously the potentials (economic and social) of their territories combining the “use” of innovation (more than the production of innovation) with a spatial perspective for European regions (MAPS-LED, 2017a: 33). The “territorial” aspect of Smart Specialisation Strategies of Foray’s concept, lies in our opinion, on the “spatialisation” concept, which is understood as a specific activity in a specific space

(region) that has the potentials in contributing to the regional economic growth. Hence, National and Regional Authorities, in implementing Operational Programmes to reach the goals of Europe 2020 Strategy, should focus on an integrated approach, linking together Cohesion, Research and Innovation and Territorial Policies. The expression of the territorial potential is relevant not only for the local dimension but also for the international openness of local markets. A consequence of the complete RIS3 process could be the possibility that the empowerment of local innovation systems could bring toward the entry of SMEs into the Global Value Chain and help the revitalisation of local economic systems (MAPS-LED, 2017a). Faludi (2015) argues that even if the S3 strategy is integrated and effective it could be hard to translate it into a spatially-oriented development policy. The need to develop a multidisciplinary approach to plan smart specialisation strategies emerges as crucial to properly pursue the local economic development's targets. Hence, the MAPS-LED project appears at forefront into this unexplored new research domain (MAPS-LED, 2017a).

6. ACKNOWLEDGEMENTS



The MAPS-LED project has received funding from the European Union's Horizon 2020 research and innovation programme under the Marie Skłodowska-Curie grant agreement No 645651.

7. REFERENCES

- Atkinson R. (2014), *The Urban Dimension in Cohesion Policy: Past developments and Future Prospects*. Paper presented at a RSA workshop on "The New Cycle of the Cohesion Policy in 2014-2020", Institute of European Studies, Vrije Universiteit Brussels, 24/03/2014.
- Barca, F. (2009), *An agenda for a reformed cohesion policy: a place-based approach to meeting European Union challenges and expectations*, Independent Report prepared at the request of Danuta Hübner, Commissioner for Regional Policy, European Commission, Brussels.
- Barca, F. et al. (2012), *The Case for Regional Development Intervention: Place-Based versus Place-Neutral approaches*. Journal of Regional Science, Vol. 52, No. 1, pp 134-152.
- Böhme K., Doucet P., Komornicki T., Zauzha J., Świątek D. (2011), *How to strengthen the territorial dimension of "Europe 2020" and EU Cohesion Policy*. Warsaw.
- Dąbrowski M. (2014), *Towards Place-Based Regional and Local Development Strategies in Central and eastern Europe?* in: "(Re)appraising place-based economic development strategies" Journal of Local Economy. Vol. 29 Issue 4-5.
- Delgado M., Porter M., Stern S. (2014), *Clusters, convergence, and economic performance*, Research policy, vol. 43, No. 10, p. 1785-1799
- European Parliament (1997), *Treaty of Amsterdam*, amending The Treaty on European Union, The Treaties Establishing The European Communities and Certain Related Acts.
- European Parliament and Council (2013), *Regulation No 1303/2013 of the European Parliament and of the Council of 17 December 2013*
- European Commission (1999), *ESDP. European Spatial Development Perspective. Towards Balanced and Sustainable Development of the Territory of the European Union*, Agreed at the Informal Council of Ministers responsible for Spatial Planning in Postdam, May 1999. Published by the European Commission
- European Commission (2007), *Leipzig Charter on Sustainable European Cities*, Final Draft, 02 May 2007
- European Commission (2007), *Territorial Agenda of the European Union. Towards a More Competitive and sustainable Europe of Diverse Regions*, Agreed on the occasion of the Informal Meeting on Urban Development and Territorial Cohesion in Leipzig on 24/25 May 2007.
- European Commission (2008), *Green Paper on Territorial Cohesion Turning territorial diversity into strength* {SEC (2008) 2550}. Brussels, 6.10.2008 COM (2008) 616 final.
- European Commission (2010), *Regional Policy contributing to smart growth in Europe 2020*, Communication from The Commission To The European Parliament, The Council, The European Economic And Social Committee And The Committee Of The Regions. Brussels, 6.10.2010 COM (2010) 553 final

- European Commission (2011), *Territorial Agenda of the European Union 2020. Towards an Inclusive, Smart and Sustainable Europe of Diverse Regions*, Agreed at the Informal Ministerial Meeting of Ministers responsible for Spatial Planning and Territorial Development on 19th May 2011, Hungary.
- European Commission (2011), *Regional Policy for Smart Growth in Europe 2020*, Directorate General for Regional Policy, Brussels.
- European Commission (2012), *Guide to Research and Innovation Strategies for Smart Specialisation (RIS3)*, Available online: <http://s3platform.jrc.ec.europa.eu/s3pguide>.
- European Commission (2013), *The Role of Clusters in Smart Specialisation Strategies*, European Commission, Directorate General for Research and Innovation
- Faludi A. (2015), *Place is a no-man's land*, Geographia Polonica Vol. 88, Issue 1, pp 5-20
- Faludi A. (2015), *S3 place-based: Look who is talking*, International Open Panel Discussion, MAPS-LED Research Project H2020, Marie Slowdoswka Curie-RISE Actions, Reggio Calabria, Italy 27-28 May 2015
- Foray, D. Hall B. H. (2009), *Smart Specialisation – the concept*, in: Knowledge for Growth. Prospects for Science, Technology and Innovation. Selected Papers from Research Commissioner Janez Potocnik's Expert Group.
- Foray, D. (2015), *On the economic fundamentals of smart specialization*, International Open Panel Discussion, MAPS-LED Research Project H2020, Marie Slowdoswka Curie-RISE Actions, Reggio Calabria, Italy 27-28 May 2015
- Foray, D. (2015), *Smart specialisation: opportunities and challenges for regional innovation policy*, Routledge, Abingdon.
- ISC (2017), *Cluster Studies*, Institute for Strategy & Competitiveness, Harvard Business School, available at <http://www.isc.hbs.edu/competitiveness-economic-development/research-and-applications/pages/cluster-studies.aspx>
- ISI (2016), *Policy Brief on Smart Specialisation*, Fraunhofer Institute for Systems and Innovation Research, ISI.
- Navarro M. et al. (2014), *Regional benchmarking in the smart specialisation process: Identification of reference regions based on structural similarity*, S3 Working Paper Series No. 03/2014. Technical Report by the Joint Research Centre of the European Commission
- McCann P. (2015), *The regional and Urban Policy of the European Union*, Edward Elgar Publishing Cheltenham.
- McCann P. and Ortega-Argilés (2013), *Smart Specialisation, Regional Growth and Applications to European Union Cohesion Policy*, Regional Studies, vol. 49, No. 8, p. 1291-1302
- MAPS-LED (2014), *Multidisciplinary Multidisciplinary Approach to Plan Smart specialisation strategies for Local Economic Development, Horizon 2020 – Marie Swlodowska Curie Actions RISE –2014*
- MAPS-LED (2017), *S3: Research and Innovation Strategies in Cluster Policies*. First Scientific Report, MAPS-LED Project, Multidisciplinary Multidisciplinary Approach to Plan Smart specialisation strategies for Local Economic Development, Horizon 2020 – Marie Swlodowska Curie Actions -RISE –2014
- MAPS-LED (2017), *S3: Cluster Policies & Spatial Planning. Knowledge Dynamics, Spatial Dimension and Entrepreneurial Discovery Process*. Second Scientific Report, MAPS-LED Project, Multidisciplinary Multidisciplinary Approach to Plan Smart specialisation strategies for Local Economic Development, Horizon 2020 – Marie Swlodowska Curie Actions -RISE –2014
- OECD (2009), *How regions Grow: Trend and Analysis*, OECD Report
- Porter M. (1998), *Clusters and the New Economics of Competition*, Harvard Business Review, p. 77-90
- Porter M. (2000), *Location, Competition and Economic Development: Local Clusters in a Global Economy*, Economic Development Quarterly, No. 1, vol. 14, p. 15-34
- S3 Platform (2015), *PXL. Feedback Report on Monitoring*, Peer eXchange & Learning Workshop, Bologna (Italy)
- S3 Platform (2017), *Entrepreneurial Discovery Process: How does the EDP affect S3 strategies?*, Smart Specialisation Platform, available at <http://s3platform.jrc.ec.europa.eu/entrepreneurial-discovery-edp>
- Schmitt P. (2011), *The Territorial Agenda of the European Union 2020 – A turning point in striving for Territorial Cohesion? In: Europe's strive for Territorial Cohesion*. Nordregio News Issue 1, October 2011
- Sörvik J. and Kleibrink A. (2015), *Mapping innovation Priorities and Specialisation Patterns in Europe*, S3 Working Paper Series No. 08/2015. JRC Technical Reports - IPTS
- Waterhout B. (2008) *The Institutionalisation of European Spatial Planning*, Series: Sustainable Urban Areas. TU Delft.
- World Bank Group (2009), *Reshaping Economic Geography*, World Development Report 2009

THE ROLE OF PUBLIC AUTHORITIES IN SUPPORTING REGIONAL INNOVATION ECOSYSTEMS: THE CASES OF SAN DIEGO AND BOSTON REGIONS (USA)

C. Bevilacqua, A. Spisto and F. Cappellano

PAU Department – University “Mediterranea” of Reggio Calabria, Italy

Email: cbevilac@unirc.it

Abstract: The EU has recently recognised the crucial role of public authorities in promoting the interfaces between innovation actors in order to orchestrate regional innovation ecosystems (EU CoR, 2016). This paper aims to contribute to the body of knowledge of regional innovation policy-making by analysing the role that has been performed by the U.S. public sector in boosting two successful innovation ecosystems, namely the Life Science Clusters of San Diego (CA) and Boston (MA). By adopting a policy monitoring methodology, the paper breaks-down the different policy inputs and processes delivered by the public sector, targeting the two Life Science clusters. We conclude that both the public authorities of Boston and San Diego regions have been pushing for the life science industry agglomeration from an urban planning perspective, while they have been adopting different approaches in promoting the interface between innovation actors. In Boston, the public authorities actively intervene in fostering collaboration and co-creation between the several life science-related firms, through the Mass Life Science Center. In San Diego, the public authorities allow the life science ecosystem to self-organize, leaving the orchestration role to not-for-profit organizations, such as CONNECT and BIOCUM.

Keywords: Clusters, Innovation Policy, MAPS-LED, Policy Mix, Regional Innovation Ecosystems.

1. INTRODUCTION

There seems to be a wide consensus among the scientific community that knowledge, education, lifelong learning, creativity, and innovation are the key components for the prosperity and global competitiveness of cities and regions. The post-Fordist societies are more and more characterized by knowledge-based economies and, for this reason, innovation ranks on the top of policy agendas within the regional policy-making field (Todtling & Trippl, 2005). As Judy Estrin reminds us, “innovation is not optional” (Estrin, 2009, p. 1).

Since Harvard Business School professor Michael Porter introduced the connection between clusters and innovation to the policy community (1990), almost ten years have passed for the spread of public strategies in supporting regional economic clusters across every U.S. state. Furthermore, it took ten more years until the U.S. Congress adopted the “regional innovation clusters” (RICs) as the framework for structuring the nation’s economic development policies (Muro & Katz, 2010).

Also for the European Union, innovation represents the key element when it comes to formulating guidelines and legislation for regional policies. For the programming period 2014 – 2020, the EU Commission pointed out the Smart Specialisation Strategy (S3) as the regional policy aiming at placing greater emphasis on innovation-driven regional development, based on each EU region’s strengths and competitive advantages (EU Commission, 2011). The development of regional clusters represents an expected - and desirable - stage within the S3 implementation, since it is recognised the crucial role of clusters’ knowledge spillovers in

boosting innovation (Baptista & Swann, 1998). The importance given to innovation and clusters development is demonstrated by two main aspects: 1) the development of the S3 plan (called RIS3 – Research and Innovation Strategies for Smart Specialisation) is the ex-ante conditionality for the EU regions in order to access the European Structural and Investment Funds (ESIF) for regional development; 2) in the RIS3 Guide, EU regions are invited to “[...] develop world class clusters and provide arenas for related variety/cross sector links internally in the region and externally, which drive specialised technological diversification” (Foray, et al., 2012, p. 17).

Besides pushing regional specialisations and agglomerations through the S3, the EU also emphasizes the importance of governance-related aspects in order to promote regional innovation and fully exploit local endowments and competitive advantages. The research carried out by several Scandinavian scholars and the Espoo Innovation Garden project (FI) have been determinant steps in developing an eco-systemic approach to regional innovation and raising the importance of well-functioning collaborative and networking platforms for the production and promotion of innovation for regional prosperity (see Rajahonka, et al., 2015; Lappalainen & Markkula, 2013; Oksanen & Hautamaki, 2014; Markkula, Kune, 2015a-b). In 2016 the EU Committee of Regions (EU CoR) – chaired by Markkula - released a guide encouraging decision-makers to foster collaboration among regional innovation actors: “Europe needs more partnering with collaborative power, creative thinking, eco- systems thinking, synthesis, and a stronger focus on outcomes and impact [...] In the face of a fast-changing world, innovation and an experimental mind-set are required more than ever. If Europe is to continue to provide quality of life for our citizens, the capacity to work together and learn from – and with – each other is essential” (EU CoR - Committee of the Regions, 2016, pp. 9, 21).

This paper contributes to the body of knowledge in the policy-making field by showing whether and how the public authorities support the interconnections between innovation players within two world-class U.S. life science clusters, located in the regions of Boston (MA) and San Diego (CA). There are two reasons we focus our study just on one cluster constituting the innovation ecosystem of the two regions: opportunity and feasibility. In terms of opportunity, 1) the economic performance of the life science cluster in both the regions is so high - 1st and 3rd in the world (JLL, 2015) - that allows to highlight the successful top-down public choices to promote innovation actors’ synergy; 2) it allows to investigate the planning aspects connected to the support of innovation ecosystems. In terms of feasibility, for their very nature - based on geographic concentration, competition, cooperation and interconnection of several actors (Porter, 2000) - clusters can be considered as a proxy of regional innovation ecosystems. Through comparing the aforementioned life science clusters we will answer the following research question: which kind of policies have been set up by the U.S. public authorities in order to orchestrate the interface between the innovation actors within the life science clusters of Boston and San Diego’ regions?

To answer this question, the paper develops through the following stages: in the section 2, we identify the main characteristics of innovation ecosystems and then connect the concept with the cluster one. Section 3 sets up the methodology and limitations in order to break-down the different public choices made by the public authorities in supporting the innovation ecosystem of the two life science clusters. In particular, we employ a policy monitoring methodology called “social auditing” (see Dunn, 2012). In the section 4, we discuss more in depth the public policy choices to support both the life science ecosystems, highlighting the main outputs of such choices. In the section 5, we conclude that both the public authorities of Boston and San

Diego regions have been pushing for the life science industry agglomeration from an urban planning perspective, while they have been adopting different approaches in promoting the interface between innovation actors. In particular, in Boston, the public authorities actively intervene in boosting collaboration and co-creation between the several life science-related firms, through the Mass Life Science Center. In San Diego, public authorities allow the life science ecosystem to self-organize, leaving the orchestration role to not-for-profit organizations, such as CONNECT and BIOCOM.

2. INNOVATION ECOSYSTEMS IN THE LITERATURE

The concept of innovation ecosystem has increasingly gained a lot of popularity in the academic and policy-making debate. In his Google N-gram chart, Hwang showed the dramatic increase of the use of this phrase from the end of the '80s to 2008 within all the vast amount of books that Google has scanned to make them available on its famous search engine (see Hwang, 2014). However, the most recent works of literature review on the concept (see Durst & Poutanen, 2013; Oh et al., 2016) show that there is not a widely recognized definition for this concept, since it can be related to different fields (business, industrial, institutional) and geographical scales (from the business to the national level). According to Durst & Poutanen's work (2013), the majority of the academic articles focused on innovation ecosystems provides different ideas and interpretations from one another. Oh et al. (2016) argue that within their literature search, first, the concept of "innovation ecosystem" does not distinguish from the "innovation system" one and, second, the eco addition appears mostly in trade publications.

The first idea that comes to mind is the analogy with the biological ecosystem. Starting from this analogy and comparing the two types of ecosystems, Jackson (2011) highlights the structural factors constituting them and provides a definition for the innovation one: "[...] the complex relationship that are formed between actors or entities whose functional goal is to enable technology development and innovation" (Jackson, 2011, p. 2). In terms of actors, Jackson refers to material resources (funds, equipment, facilities, etc.) and human capital (students, faculty, staff, industry researchers, industry representatives), while entities are meant to be made up of these actors and they are the institutions participating to the ecosystem (e.g. the universities, colleges of engineering, business schools, business firms, venture capitalists, industry-university research institutes, federal or industrial supported centres of excellence, and state and/or local economic development and business assistance organizations, funding agencies, policy makers, etc.). Similarly, Mercan & Goktas (2011), describe the innovation ecosystem as a complex environment made up by different actors and relations: "innovation ecosystem consists of economic agents and economic relations as well as the non-economic parts such as technology, institutions, sociological interactions and the culture" (Mercan & Goktas, 2011, p. 102). Estrin (2009) also starts from the biological analogy and identifies a hierarchy among the members of the innovation ecosystem. She recognizes in the research, development, and applications communities those with the role of sparking innovation. According to Estrin, the "cross-pollination" of ideas, questions, knowledge and technology between the three communities is similar to the interaction occurring among all the species within a tidal pool, which creates a unique ecosystem. The "nutrients" supporting each of these communities are funding, policy-making, education and culture (Estrin, 2009). The idea of specific communities pursuing innovation – so-called innovation communities – is also put forward by Wang (2009, p.7): "an innovation community is a set of organizations and people with interests in producing and/or using a specific innovation". The networks among these

communities and their interaction to produce and use innovation represents an innovation ecosystem.

Adner (2006) describes innovation ecosystems mostly as a thriving business environment: “the collaborative arrangements through which firms combine their individual offerings into a coherent, customer-facing solution” (Adner, 2006, p. 2). The benefits for the firms part of the ecosystem are in terms of productivity and value creation, and they are labelled as platform leadership, keystone strategies, open innovation, value networks, and hyperlinked organizations (Adner, 2006). Adner’s idea is similar to the older concept of *business ecosystem* developed by Moore (1993), who considers the ecosystem composed by individuals and organizations producing value and services for consumers, the latter also part of the ecosystem. In 1999 Moore expanded the concept of business ecosystem including also financing providers, trade associations, standard bodies, labour unions, governmental and quasigovernmental institutions, and other interested parties. The reason is that each one of these actors fills out the need of one another in complementary way (Moore, 1999). Another description, still belonging to the business and management field, is given by Autio & Thomas (2014), who highlight the 1) interconnectedness characterizing the factors and actors constituting the ecosystem and 2) vertical and horizontal relationship between the actors. Based on the study of Adner & Kapoor (2010), Iansiti & Levien (2004) and Teece (2009), Nambisan & Baron (2013) highlight three main factors of innovation ecosystems: interdependencies among the members, shared set of knowledge and skills, and a common set of aims (Nambisan & Baron, 2013).

Moving to the regional policy-making context, the concept of regional innovation ecosystem perfectly reflects - at different scale - the descriptions shown above. Also in this case innovation ecosystems are used to describe all the collaborating actors having different roles and responsibilities in the production and promotion of innovation (Lappalainen & Markkula, 2013). The partners of regional innovation ecosystems are those constituting the so-called Quadruple Helix – universities, business, governments, NGOs and citizens. The Quadruple Helix model is based on the cross-sectorial co-opetition, co-evolution and co-specialisation between all the aforementioned actors within the regional innovation ecosystem (Carayannis & Campbell, 2009). They all experience multiple gains from an open, participative and collaborative innovation process: “[...] business can develop the scalable product and service solutions that users want, the public sector can provide effective and affordable solutions to regional challenges, citizens share ownership of the specific, often highly personalized solutions they need, and universities can actively contribute knowledge and reap new knowledge and insights in return” (Markkula & Kune, 2015a, p. 17).

In conclusion, even agreeing with the argument about the lack of a specific definition and the different fields and geographical scales the concept can be applied to, we think that the aforementioned descriptions of innovation ecosystem provide a straightforward idea of the characteristics of such an environment: cross-sectorial, collaborative and – above all - explicitly systemic, the latter also highlighted by Oh et al. (2016). Furthermore, innovation ecosystems distinguish from the Porter’s clusters since the latter is a physical agglomeration with a defined spatial dimension, which can be national and regional. Instead, innovation ecosystems, as collaborative relationships among several actors, may have also a world-wide geographical scale (global innovation ecosystem). However, adding the regional attribute, innovation ecosystems acquire a spatial dimension too, which allows to argue that a cluster - at regional level - may be part of a regional innovation ecosystem, while a single cluster can be considered as specific innovation ecosystem per se. This argument is also supported by the EU

Commission’s idea of cluster: “Clusters are potential elements of a regional innovation ecosystem [...]” (EU Commission, 2013, p. 16).

Even being collaborative, regional innovation ecosystems needs to be *orchestrated* in order to contribute the addressing of societal challenges while guaranteeing regional competitiveness. The guide for EU cities and regions released in 2016 by the EU Committee of Regions (EU CoR) highlights the crucial role of public authorities in promoting the interfaces between innovation actors in order to orchestrate regional innovation ecosystems: “[...] innovation ecosystems are self-organising systems but evolve through an interaction between top-down policy choices and bottom-up creative forces [...] The role of public policies is to facilitate the ongoing process of the discovery of new opportunities. Be it through the provision of resources, such as education or infrastructures, or through the articulation of demand, such as public procurement. But more strategic: by promoting the interfaces between innovation actors” (EU CoR, 2016, p. 11). In the next section, the paper highlights the top-down policy choices made by the public sector in order to orchestrate the life science sector of the Boston and San Diego regions.

3. CASE STUDY & METHODOLOGY

The two examined regions were selected upon their remarkable performances which allow to the successful top-down public choices to promote innovation actors’ synergy. Furthermore, the two clusters have been considered as a proxy of regional innovation ecosystems for their very nature as explained in the previous section. The two study cases have been analyzed through a clear methodology, suitable to observe the two approaches adopted by public authorities in the Boston and San Diego regions. According to an inductive approach we explore the public choices in compliance with a policy monitoring procedure. To do so, we consider both inputs and processes set by local public authorities in the two study cases in compliance with the “social auditing” methodology (Dunn, 2012) indicated in the framework below (Table 1). The qualitative and quantitative data used within the methodology are secondary.

Table 1: Social auditing methodology (Dunn, 2012)

POLICY ACTIONS	POLICY OUTCOMES
POLICY INPUTS	POLICY OUTPUTS
Resources used to produce impacts and outputs: time, money, personnel, equipment, supply	Goods, services and resources received by target groups and beneficiaries
POLICY PROCESSES	POLICY IMPACTS
Administrative, organizational and political activities and attitudes that shape the transformation of policy inputs into impacts and outputs	Actual changes in behaviour that result from policy outputs

The analysis will be discussed in two following steps: 1) firstly urban planning choices implemented in the two regions will be examined since they were determinant for the physical cluster formation; 2) afterwards, we will shed light on the orchestration of the innovation ecosystem development and the relative choices made by the public sector. The focus of the analysis is confined under two criteria: the spatial boundaries will imply only the geographical areas where the sector employment is highly concentrated whereas the industry sectors investigated are referred to the broad umbrella of “Life Science”. The composition of this

cluster implies several industry sectors (NAICS – North America Industry Classification System) including: Drugs and pharmaceuticals; Medical Devices equipment; Research testing and laboratories; Bioscience-related Distribution. Notwithstanding there are some discrepancies concerning the definitions of the Life Science cluster across the two regions observed. In San Diego, for instance, some NAICS mostly related to “M-Health or Wireless Health” and “Agricultural Feedstock and animals” are included in the cluster composition.

Under these premises, we confined the spectrum of policy choices to those directly targeting the “Life Science” cluster. In this respect, any cross-cutting policy effort has been considered a possible confounding variable and accordingly excluded from the present analysis. Moreover, the limited data availability referring to these particular areas forbids us to lead any conclusion concerning the causality between the planning practices and their economic outputs. considering some planning practices (namely Life Science Corridor in Massachusetts and the University City Community plan) entered into force in 2013 and 2015 respectively. We report the main findings of the analysis conducted in Table 2.

Table 2: Social auditing methodology applied to San Diego and Boston regions’ Life Science Clusters (Authors’ elaboration based on Dunn, 2012)

	POLICY ACTIONS		POLICY OUTCOMES	
	INPUTS	PROCESSES	OUTPUTS	IMPACTS
SAN DIEGO REGION	Zoning	Scientific Research Zone	8% land use in University City is zoned to host life science labs.	Employment 64490,00 Emp. Growth rate -3,10%
	Infrastructure provision	Guaranteed Water for Industry Program	Uninterruptible supply of water for manufacturing and R&D firms	Establishments growth rate 3,00%
		Public Transportation	Metropolitan Transit Service (MTS) routes that serve the main Life Science R&D and employment centres	% VC to total U.S. 6,88% % NIH to total U.S. 7,35%
BOSTON GREATER AREA	Zoning	Life Science Corridor	Agglomeration of life science firms in the surrounding of the mass transit Red Line - over 27.7 million square feet of Research & Development /Lab (Existing, planned or under construction).	Employment 86235,0 Emp. growth rate 1,30% Establishments growth rate 4,30%
		Massachusetts Life Science		% VC to total U.S. 38,01%

	Funding & collaboration	Centre Programs	Total budget of 1billion \$	% NIH to total U.S. 18,72%
--	-------------------------	------------------------	------------------------------------	-------------------------------

4. DISCUSSION

As the Table 1 demonstrates, the two regions we review in this study are the top-ranking in the country for the life science clusters. This paragraph sheds light on the policies set forward by public authorities as well as on the policy processes that involve various stakeholders.

4.1 The case of San Diego

In San Diego, a specific urban policy devoted to spurring research facilities concentration dates back to 1900s when the first research institutions were placed. In 1907 hundreds of public land acres were ceased to build new research facilities in Torrey Pines mesa (San Diego Regional EDC, 2015). Over time, the University of California – San Diego (UCSD) and several other research institutions located in neighbouring areas began a fruitful collaboration with the City of San Diego, which has been leading to the tailored urban planning interventions (see Economic Development strategies 2002, 2008, and 2014 by the City of San Diego) discussed below. In compliance with the methodology adopted, the urban planning tools are considered as *policy inputs* - which include zoning, infrastructure provision and job training programs. These direct interventions have been coupled with other types of infrastructures which indirectly create competitive advantages for the cluster, such as the port of San Diego and the borders which ensure great communications and important gateways for the whole economic activities in the San Diego area. The aforementioned *policy inputs* can be considered as a result of a long lasting and complex policy process which involved both public and not public stakeholders. We are primarily concerned with the region around University City and the neighbouring areas, including La Jolla and Torrey Pines Mesa. We focus on this region given its prominence in the sector employment as demonstrated in Figure 1.

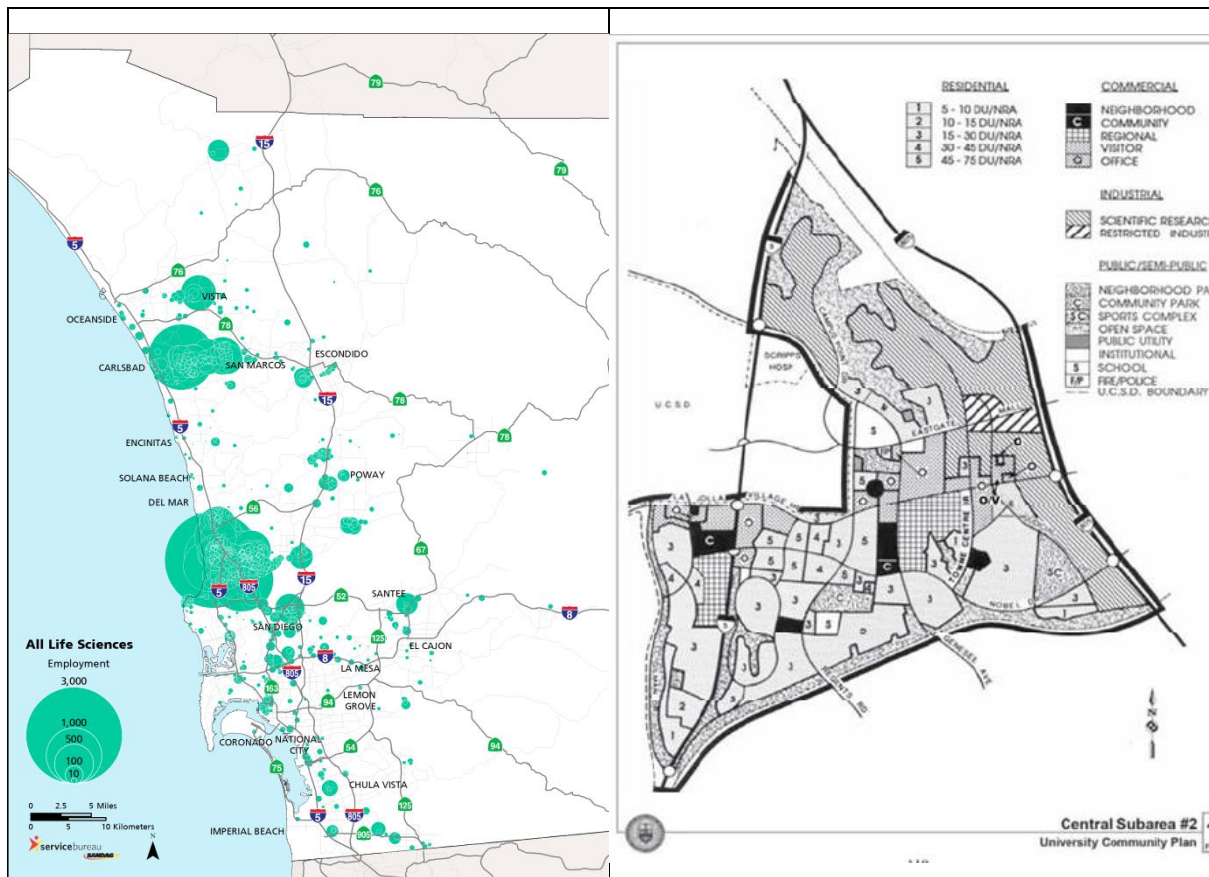

Figure 1a: Life Science Employment Map (San Diego Workforce Partnership, 2014);
 Figure 1b: University City Land Use (The City of San Diego, 2015a)

The University Community Plan was advocated by the UCSD. The City developed it upon the idea - nurtured by the public officials - to create a life science cluster, since they forecasted a strong development in the area (Kim, 2015). Hence, long-lasting ties with research anchor institutions and extensive public outreach have been inherent features of San Diego’s planning process - in compliance with the so called “Community planning” approach. The City rewarded considerable attention to the need of employees as well as companies naming a specific land use, as the Scientific Research which includes: research laboratories, supporting facilities, headquarters or administrative offices and personnel accommodations, and related manufacturing activities (The City of San Diego, 2015b). However, the urban planning processes were not only focused to the provision of specific zoning. At the request of the local biotechnology industry’s representatives (called BIOCOM), the City implemented a tailored program (the “Guaranteed Water for Industry Program”) to offset the drought which represents a serious threat to manufacturing and R&D firms, since they are highly dependent on water for industrial processing and cooling needs. Furthermore, the City of San Diego has been committed in providing a public transportation service to the most significant employment and R&D centres (namely, the areas neighbouring UCSD campus). For transportation planning, the City of San Diego relies on the local Metropolitan Planning Organization (called SANDAG) which is responsible for planning and programming financial resources for a multi-modal transportation system.

In sum, the city of San Diego adopted similar approach as several other cities (e.g. New York City, Novato City and Boston) by right sizing the zoning, streamlining permits, strengthening the infrastructure provision. In this respect, the “Development Intensity” element within the

University City's Community Plan allows higher density in order to reinforce the existing patterns, accounting a percentage around 8% of land devoted to Life Science/Research. The land devoted to the "SR Zone" accounts for 1,047 gross acres and will allow 14,359,530 s.f. (The City of San Diego, 2015a) of facilities in order to accommodate additional 9,665 jobs, forecasted by 2018 (The City of San Diego, 2014). In respect of public transportation, the City intervened by placing additional 14 Metropolitan Transit Service (MTS) routes in order to serve the University community. Moreover, through SANDAG, the City has planned, funded and started to implement the Mid-Coast trolley project which runs through the University City region. This project will extend the existent LRT (the Blue Line trolley) which will serve the UCSD campus and the surrounding areas. As shown, the City set the ground for the geographical concentration of the life science industry, research organizations and venture capital (Powell et al., 2002, in Majava, Rinkinen, & Harmaakorpi, 2015), which represent the basis for "a robust entrepreneurial activity and the formation of entrepreneurial habitats" (Kim, 2015, p. 3). Along this paragraph, we explore how the public choices supported the innovation ecosystem. Drafting on the relationships nurtured by the City, it is remarkable the role exerted by not-for profit organizations BIOCUM and CONNECT who has been building strong ties with public officials. Their relevance is twofold: on one side, they has been advocating innovation process by lobbying government at all levels and establishing collaborations with SANDAG and San Diego EDC (Walcott, 2002); on the other side, since their foundation, they have been serving as collaboration platform for both entrepreneurs and academics within the life science sector in order to boost entrepreneurship and technology transfer (Kim, 2015).

Hence, the case of San Diego witnesses how innovation ecosystem relies on flows of knowledge - as demonstrated by Kim (2015) - which are critical to "power collaboration and co-creation" (Gobble, 2015). At this regard, the talented managers attracted in San Diego were critical to create fruitful human networks which are considered the main reason for the cluster success (Walcott, 2002). Moreover, they developed a wide-spread entrepreneurial culture in the area (Walcott, 2002; Kim, 2015; Casper, 2014) which is crucial to support attempts toward commercializing the research outcomes carried out in the local clinic or R&D facilities. In fact, the UCSD and the outstanding independent research institutions (Scripps Research Institute, Sanford Brunham Prebys and Salk Institute for Biological Studies) have been at the forefront in the research. They are all ranked among the 10 most performing research institutes upon the NIH funding (San Diego Regional EDC, 2015). Additionally, the sum of patents (704 in 2014) resulting from this public funding sources (ib.) witnesses the efficiency of the public expenditures invested in those centers. This first-tier scientific environment is fed by a talented workforce available in the area given the presence of important universities in San Diego (namely UCSD, SDSU, USD). Moreover, job/training programs, (e.g. Life Science Summer Institute) provided by the City of San Diego through the San Diego Workforce Partnership, spread the know-how over next generations of students and teachers who reach San Diego every year from all over the U.S in order to appreciate a real-life work experience in the life science industry (The City of San Diego, 2014). Additionally, several other factors make part of the ecosystem and work significantly to its degree of innovation, including: considerable supply of venture capitalists which afford risk financing, a three-tier real estate market providing space for companies from incubation to start-up and through established market-seasoned success (Walcott, 2002) accelerators, incubators and angel investors by sharing their knowledge support the rise of new economic activities, health providers who partner in clinical trials, further business services leverage their expertise in financial, legal, human resources fields (Majava, et al., 2016).

Notwithstanding, harnessing innovation ecosystem is not limited only to local actors. In fact, even regulatory agencies and municipal or regional governments that create a dynamic, innovation-driven economy can be involved in the orchestration process. In this respect, federal legislation (namely the federal Bayh–Dole Act or Patent and Trademark Law Amendments Act) deeded the property rights for federally-funded technology to not for profit universities (Walcott, 2002). By allowing that, a number of companies settled down close to anchor R&D institutions to turn research outcomes into patents as demonstrated by the data aforementioned. Additionally, actors at state level prompted a crucial contribution to the multi-scalar-featured policy process: 1) the State of California supports the University of California (UCSD) allocates the 20% of resources reported in their annual budget of the UC system; 2) the University of California played a significant role in the 1980s when it laid the basis for a biotech base through university technology transfers in San Diego (Walcott, 2002; Markoff, 1997). Such multi-faceted ecosystem is unique for its government since the leaders of BIOCOM and CONNECT are the ones who play a prominent role in the orchestration of the innovative ecosystem (Majava, et al., 2016). In fact, the City of San Diego forecasted the development of the life science sector and so implemented an urban policy to set the ground for the cluster development earmarking resources (water, zoning, and infrastructure provision) and attention to the cluster needs. As claimed by a public official, the City consciously limited its efforts in providing the aforementioned inputs (Kim, 2015) leaving the orchestration role to private and not-for-profit sector. In fact, “since 1980s when the major actors see a gap in the ecosystem, they tend to fix it without top-down guidance” (Majava, et al., 2016, p. 10).

In conclusion, a multi-scalar featured and complex policy process as a whole achieved to orchestrate a well-performing regional innovation ecosystem. A combination of federal legislation and educational state-funded policies contributed to leverage the human capital toward innovation.

4.2 The case of Boston

The case of Boston, defined as “supercluster”, represents the best performing life science cluster in the world by attracting firms, companies, venture capital and private banks (Business Wire, 2015). By a planning perspective, local authorities have accommodated the life science ecosystem development through specific urban planning tools – such as zoning to increase life science-related spaces, streamlined process to permit buildings and sites for biotech-uses in their municipal plans, life science-related planned area development. At this regard, the MassBio - a not-for-profit organization representing the actors working in the life science field and providing services and support for the ecosystem - has developed an index - called BioReady - considering the zoning practices and the degree of infrastructure provisioned as suitable to host life science companies or facilities (see <https://www.massbio.org/why-massachusetts/supercluster/bioready-communities>). The results claim that five cities are top-rated and that they are linked by the mass-transit infrastructure - namely the Red-Line operated by the MBTA. These cities (Somerville, Cambridge, Boston, Quincy, Braintree) joined in 2013 to promote the “Life Science Corridor”. Hence, more companies are attracted by the abundance of R&D facilities (e.g. 27.7 million square feet of Research & Development /Lab) around the Corridor. Moreover, the choice to adopt a Transit Oriented Development scheme (developed around mass transit line) generates stark economic advantages in terms of greater workforce/employers access, lower transportation costs which self-reinforces the business attraction. Such tailored urban planning policy led to a physical agglomeration of life science

sector companies which is forecasted to increase over time given the presence of top-ranked universities in the world (e.g. Harvard, MIT, Tufts, Boston University, etc.).

The Mass Life Science Centre represents not only a massive fiscal stimulus which granted a 1\$ billion in aid to boost the Life Science sector in the Boston area (Bluestone & Clayton-Matthews, 2013). Additionally, it depicts the strong ties among the different actors within the regional innovation ecosystem. In fact, the structure itself of the Mass Life Science Centre does include representatives from academia and from private sectors. For instance, its board is composed by government officials, industry CEOs and leaders from academia (ib.). In a certain extent, we can state that the “Triple Helix” takes place in this tailored structured. Additionally, the public funds’ allocation is assessed by a panel which gathers up to 200 specialists including: “academic researchers, industry scientists and private venture capital experts” (ib., p. 6). Their evaluation takes into account the scientific extent and the economic return of investment. Such articulated structure does not affect the time process of public funds’ allocation but it enhances the efficiency of the public expenditure. In fact, the massive state-funded MLSC is proven to be very effective since till 2013 has been reported to generate \$ 1,66 gain per each state dollar spent (ib.). The initiative has been in charge of the state of Massachusetts since 2008, lasting for ten years. The Centre works trough implementing seven programs which earmark resources throughout the whole R&D pipeline including: the research institutions, the start-ups, SMEs, bigger companies, business incubators and not-for-profit organizations. The main rationale of the MLSC is centred in supporting small and medium enterprises as well as start-ups. According to Bluestone and Clayton-Matthews (2013), “[...] In the life science and other innovative sectors [...] the large companies that depend on the development of breakthrough innovations and sophisticated medical devices prosper by being near a concentration of small start-firms”(ib., p. 8). The authors explain this defined business location pattern since the large companies can take stock of “the scientific discoveries under way in university research laboratories and in the transnational research carried out by small start-ups” (ib., p. 40) and eventually invest in the most promising outcomes. Such detailed and robust policy process implemented in Boston succeeded to achieve outstanding outputs. In fact, 36250 people are employed in 450 Life Science companies with over 150 million square feet of lab space available considering only the specific region of the Life Science Corridor.

5. CONCLUSIONS

With the shift to a knowledge-based economy, to be innovative and creative is not advice for just young people anymore. Rather, it represents the new policy imperative that cities and regions should follow in order to prosper and be competitive in a globalized world. The nurturing of regional innovation ecosystems is widely claimed to be the most effective way to pursue the production and use of innovation for regions’ growth. As well as in the biological ecosystem all the living species interact with one another and with the environment they live in, as in innovation ecosystems all the actors constituting cities and regions – universities, businesses, public institutions, civic society and NGOs – have to collaborate in order to contribute the ecosystem’s success.

By analysing the role that public authorities perform in supporting two successful U.S. innovation ecosystems- the life science clusters of Boston (MA) and San Diego (CA) regions – this paper contributes the knowledge in the policy-making field by clearly breaking down all the strategies adopted for regions’ prosperity, thus identifying the different approaches in promoting the interfaces between ecosystem’s innovation actors. In particular, two main

findings can be highlighted within this research: first, either in Boston and San Diego regions, public authorities promote the clustering of life-science related actors through specific zoning tools and infrastructures provision. Beside the water supply and the public transportation development, San Diego's public authorities set up the Community Plan of University City neighbourhood in order to devote the 8% of the land use to host life science-related laboratories (Scientific Research Zone). In the Boston region, local authorities have accommodated the life science ecosystem development through specific urban planning tools – such as zoning to increase life science-related spaces, streamlined process to permit buildings and sites for biotech-uses in their municipal plans, and life science-related planned area development. The increase of life science-related land uses is boosted also by MassBIO's rating for municipalities, whose aim is to help companies to locate in the best-rated municipalities – based on their zoning rules easing the location of life science-related firms.

The second finding concerns the role of the public authorities in supporting the synergies among the life science-related actors. The public founded Mass Life Science Center works as a platform providing incentives and collaborative programs targeted to the life science ecosystem. It creates new models for collaboration and partnership with both public and private actors from local to the global level, in order to boost its innovation ecosystem. The public leadership in orchestrating the life science innovation ecosystem have been proving societal benefitting, as demonstrated by the public return on the MLSC investments. In the San Diego region, the interfaces between the life science ecosystem's innovation actors is supported by two main not-for-profit organizations, namely BIOCUM and CONNECT. The latter work as collaborative platform aimed to boost life science-related entrepreneurship and technology transfer. As explained in the previous section, this bottom-up and self-organizing feature of San Diego's life science ecosystem is probably due to historical reasons characterizing the entrepreneurial environment and the connections universities-firms.

6. ACKNOWLEDGMENTS

The MAPS-LED project has received funding from the European Union's Horizon 2020 research and innovation programme under the Marie Skłodowska-Curie grant agreement No 645651.

7. REFERENCES

- Adner, R. (2006). Match your innovation strategy to your innovation ecosystem. *Harvard Business Review* , 84.
- Adner, R., & Kapoor, R. (2009). Value creation in innovation ecosystems: how the structure of technological interdependence affects firm performance in new technology generations. *Strategic Management Journal* , 31, 306-333.
- Autio, E., & Thomas, L. D. (2013). Innovation ecosystems: implications for innovation management? In M. Dodgson, D. M. Gann, & N. Phillips (Eds.), *The Oxford handbook of innovation management* (p. 752). Oxford: Oxford University Press.
- Baptista, R., & Swann, P. (1998). Do firms in clusters innovate more? *Research Policy* , 27, 525-540.
- Bluestone, B., & Clayton-Matthews, A. (2013). *Life Science Innovation as a catalyst for Economic Development: the role of Massachusetts Life Center*. Boston, MA: Boston Foundation.
- Business Wire. (2015). *New Wells Fargo Life Sciences Unit in Boston Eyes Supercluster*. Retrieved April 2017, from businesswire.com: <http://www.businesswire.com/news/home/20150127005281/en/Wells-Fargo-Life-Sciences-Unit-Boston-Eyes>
- Carayannis, E. G., & Campbell, D. F. (2009). 'Mode 3' and 'Quadruple Helix': Toward a 21st century fractal innovation ecosystem. *International Journal of Technology Management* , 46 (3/4).

- Casper, S. (2014). The University of California and the evolution of the biotechnology industry in San Diego and San Francisco Area. In M. Kenney, & D. Mowery, *Public Universities and Regional Growth: Insights from the University of California* (pp. 66-96). Stanford, CA, USA: Stanford University Press.
- Dunn, W. N. (2012). *Public policy analysis: an introduction* (5th edition ed.). New York, NY - USA: Routledge.
- Durst, S., & Poutanen, P. (2013). Success factors of innovation ecosystems - Initial insights from a literature review. In R. Smeds, & O. Irrmann, *Co-create 2013 - The Boundary-Crossing Conference on Co-Design in Innovation: Conference proceedings* (Vol. 15). Helsinki: Aalto University publication series Science and Technology.
- Estrin, J. (2009). *Closing the innovation gap: reigniting the spark of creativity in a global economy*. New York: McGraw-Hill.
- EU Commission. (2011). *Regional Policy for Smart Growth in Europe 2020*. Brussels: European Commission.
- EU Commission. (2013). *The role of clusters in smart specialisation strategies*. DG Research and Innovation. Brussels: EU Commission.
- EU CoR - Committee of the Regions. (2016). *Regional Innovation Ecosystems - Learning from the EU's cities and regions*. European Union.
- Foray, D., Goddard, J., Goenaga, X. B., Landabaso, M., McCann, P., Morgan, K., et al. (2012). *Guide to Research and Innovation Strategies for Smart Specialisations (RIS3)*. EU Commission.
- Gobble, M. M. (2015). Charting the Innovation Ecosystem. *Research Technology Management*, 57:4, 55-59.
- Hwang, V. W. (2014). *The Next Big Business Buzzword: Ecosystem?* Retrieved April 2017, from forbes.com: <https://www.forbes.com/sites/victorhwang/2014/04/16/the-next-big-business-buzzword-ecosystem/#220316d75456>
- Iansiti, M., & Levien, R. (2004). *The keystone advantage*. Boston, MA: HBS Press.
- Jackson, B. D. (2011). What is an innovation ecosystem? Arlington, VA: National Science Foundation.
- JLL. (2015). *Life Sciences Outlook*. San Diego, CA: JLL.
- Kim, S.-T. (2015). Regional Advantage of Cluster Development: A Case Study of the San Diego Biotechnology Cluster. *European Planning Studies*, 23:2, 238-261.
- Lappalainen, P., & Markkula, M. (2013). *The Knowledge Triangle - Re-inventing the Future*. European Society for Engineering Education SEFI - Aalto University - Universitat Politècnica de València.
- Majava, J., Rinkinen, S., & Harmaakorpi, V. (2016). Development of San Diego Life Sciences Ecosystem. *Finnish policy research seminar: Growth ecosystems as an innovation policy tool*. The Ministry of Economic Affairs and Employment, the Finnish Funding Agency for Innovation TEKES and the Finnish Innovation Fund SITRA.
- Makela, J., & Savolainen, O. (2016). Forward. In P. Lappalainen, M. Markkula, & H. Kune (Eds.), *Orchestrating Regional Innovation Ecosystem - Espoo Innovation Garden* (p. 10). Helsinki: Aalto University in cooperation with Laurea University of Applied Sciences and Built Environment Innovations RYM Ltd.
- Markkula, M., & Kune, H. (2015a). From Research to Reality. In P. Lappalainen, M. Markkula, & H. Kune (Eds.), *Orchestrating Regional Innovation Ecosystems - Espoo Innovation Garden* (p. 17). Helsinki: Aalto University in cooperation with Laurea University of Applied Sciences and Built Environment Innovations RYM Ltd.
- Markkula, M., & Kune, H. (2015b). Making Smart Regions Smarter: Smart Specialization and the Role of Universities in Regional Innovation Ecosystems. *Technology Innovation Management Review*, 5 (10).
- Markoff, J. (1997, March 24). San Diego—the wireless valley: An information revolution revives its economy. *New York Times*, pp. C1, C6.
- MassBio. (n.a.). *Bioready Communities*. Retrieved April 2017, from MassBio - Massachusetts Biotechnology Council: <https://www.massbio.org/why-massachusetts/supercluster/bioready-communities>
- Mercan, B., & Goktas, D. (2011). Components of Innovation Ecosystems: A Cross-Country Study. *International Research Journal of Finance and Economics* (76), 102-112.
- MLSC. (n.a.). *Massachusetts Life Science Center Funding Programs*. Retrieved April 2017, from Massachusetts Life Science Center: <http://www.masslifesciences.com/programs/>
- Moore, J. F. (1993). Predators and prey: a new ecology of competition. *Harvard Business Review*, 71, 75-86.
- Moore, J. F. (1999). The rise of new corporate form. *The Washington Quarterly*, 21 (1), 167-181.
- Muro, M., & Katz, B. (2010). *The new 'cluster moment': how regional innovation clusters can foster the next economy*. Brookings Institution, Metropolitan Policy Program. Washington DC: Brookings Institution.
- Nambisan, S., & Baron, R. A. (2013). Entrepreneurship in innovation ecosystems: entrepreneurs' self-regulatory processes and their implications for new venture success. *Entrepreneurship theory and practice*, 37 (5), 1071-1097.
- Oh, D.-S., Phillips, F., Park, S., & Lee, E. (2016). Innovation ecosystems: a critical examination. *Technovation*.
- Oksanen, K., & Hautamaki, A. (2014). Transforming regions into innovation ecosystems: A model for renewing local industrial structures. *The Innovation Journal: The Public Sector Innovation Journal*, 19 (2).

- Porter, M. E. (2000). Location, Competition, and Economic Development: Local Clusters in a Global Economy . *Economic Development Quarterly* , 14 (1).
- Powell, W. W., Koput, K. W., Bowie, J. I. and Smith-Doerr, L. (2002). The Spatial Clustering of Science and Capital: Accounting for Biotech Firm-Venture Capital Relationships. *Regional Studies*, 36 (3), 291-305.
- Rajahonka, M., Pienonen, T., Kuusisto, R., & Handelberg, J. (2015). Orchestrators of Innovation-Driven Regional Development: Experiences from the INNOFOKUS Project and Change2020 Programme. *Technology Innovation Management Review* , 5 (10).
- San Diego Regional EDC. (2015). *The Economic Impact of San Diego's Research Institutions Driving San Diego's Innovation Economy*. San Diego, CA.
- San Diego Workforce Partnership. (2014). *Life Science labor analysis San Diego county*. San Diego, CA.
- Teece, D. J. (2009). *Dynamic capabilities and strategic management*. Oxford: Oxford University Press.
- The City of San Diego. (2014). *Economic Development Strategy 2014-2016*. San Diego, CA.
- The City of San Diego. (2015a). *Community Plan University City*. San Diego, CA.
- The City of San Diego. (2015b). *Report to the Planning Commission*. San Diego, CA, USA: The City of San Diego.
- Todtling, F., & Trippl, M. (2005). One size fits all? Towards a differentiated regional innovation policy approach. *Research Policy* , 34, 1203-1219.
- Walcott, S. M. (2002). Analyzing an Innovative Environment: San Diego as a Bioscience Beachhead. *Economic Development Quarterly* , 99-114.
- Wang, P. (2009). An Integrative Framework for Understanding the Innovation Ecosystem. *Advancing the Study of Innovation and Globalization in Organizations*.

NATURE-BASED AND INNOVATION-LED URBAN REGENERATION: A HYPOTHESIS OF GREEN DISTRICT FOR THE METROPOLITAN CITY OF REGGIO CALABRIA

D. E. Massimo¹, C. Bevilacqua², P. Pizzimenti² and Carla Maione²

¹PAU Department, GevaulLab, Università Mediterranea, Via Melissari, Reggio Calabria, 89124, Italy

²PAU Department, CLUDsLab, Università Mediterranea, Via Melissari, Reggio Calabria, 89124, Italy

Email: c.bevilac@unirc.it

Abstract: The interest in nature-based solutions for urban regeneration increased rapidly during the last years. Urban areas are affected by the side effects of rapid urbanisation processes which need to be tackled quickly. The European Union placed the nature-based urban regeneration topic on the top of EU research areas' priorities in order to improve the well-being in urban areas, increase the sustainable use of energy and boost carbon sequestration. The aim of the paper is to understand how the introduction of nature-based solutions in innovation-led urban regeneration can contribute to the realisation of a green district in a central neighbourhood of the Metropolitan City of Reggio Calabria (IT). The proposal will be framed into an urban regeneration model in order to propose a replicable model to apply in other distressed urban areas impacting on the social, economic and environmental dimension. Findings, deriving from the MAPS-LED Project (CLUDs Lab) and Gevaul Lab research activities, will show the positive impacts of the proposed nature-based and innovation-led solution at urban district level in terms of carbon sequestration, energy and money savings, in consistence with the main aim of Europe 2020 strategy: reach a smart, inclusive and sustainable growth.

Keywords: Green District, MAPS-LED, Nature-Based Solutions, Sustainable Urban Development, Urban Regeneration

1. INTRODUCTION

The aim of the paper is to understand how the introduction of nature-based urban regeneration could contribute to the realisation of a green district in a central neighbourhood of the Metropolitan City of Reggio Calabria (IT). The need of converting a neighbourhood into a green district responds to the rapid change in the quality of the urban environment and, consequently, in the quality of life (Bai, 2012). Urban areas are currently affected by the side effects of rapid urbanisation processes. According with the UN estimations (2014), the 54 per cent of the global population live in urban areas with a potential increase to the 66 per cent in 2050. Europe reveals the most urbanised regions of the world, with a total of the 73 per cent of population living in urban areas (UN, 2014). The emerging demand of services, especially those related to ICT, Financial Market, Education (Hall, 2001), is the main push of the urbanization process in the global era. The role of the city as engine of economic growth becomes more and more relevant. The concerns about unemployment, social exclusion and environmental impacts are growing faster, as well. The environmental pressures raise up as one of the most important problem to tackle, especially due to the climate change effects. The introduction of sustainability principles, in order to balance competitiveness and economic growth, affected the planning system during last decades, emphasising the need to re-nature cities in the reaffirmation of ecological processes as a base for the future development. The awareness of establishing a new and balanced relationship between nature and human activities is no longer seen as just a constraint but as an opportunity for a sustainable and equitable growth. The European Union recognised the importance of re-naturing cities and territories with the adoption of the Research and Innovation Policy Agenda for Nature-based solutions

(EC, 2015). One of the research priorities focuses on nature based urban regeneration to enhance sustainable urbanisation. The development of proper and feasible solutions able to enhance sustainability through urban regeneration is a complex and dynamic process (Bevilacqua & Trillo, 2012). Urban regeneration is characterised by a “comprehensive integration of vision and action” (Zheng et al. 2014: 272) and is acquiring a powerful role in shaping the future of cities (Bevilacqua, 2012). In order to understand how nature based solutions can be integrated in suitable urban regeneration initiatives the paper is structured as follows. The first section briefly describes the relationship between nature and city from a planning perspective. It begins with the change imposed by sustainable development principles to the planning system and introduces the centrality of urban regeneration in reaching a sustainable urban development in the EU policy context. The second section introduces the concept of nature-based solutions reporting the available definitions, their main characteristics and information on the EU Research and Innovation Agenda on Nature Based Solutions (NBS). The third section describes the elements taken into account for the proposal of a green district starting from the application of nature based solutions for building energy retrofitting in a central neighbourhood of the City of Reggio Calabria (IT). Data deriving from the comparative scenario analysis applied to the small scale experimental activity will be estimated for the considered district. The results illustrate the benefits deriving from a possible application at larger scale (district) in terms of carbon sequestration, energy and money savings. These elements will be framed into an urban regeneration scheme coherent with objectives of the EU Cohesion Policy following the Smart Specialisation Strategies (S3) perspective. The results allow to propose a possible green district model based on the concept of nature based urban regeneration in order to enhance sustainable urbanisation processes.

2. TOWARDS THE SUSTAINABLE URBAN DEVELOPMENT

2.1. The relationship between city and nature from a planning perspective

Sustainable Urban Development is a central element in the urban planning debate since the 1990s (Hall, 2014). The positions on how to address it shifted from the conservationist approach (1970s) to more complex positions (1980s) that have introduced sustainable development principles for national and local policies (Healey and Shaw, 1993). These principles imposed a change in the planning processes characterised by the myth of continuous growth. The golden age of planning was ended (Hall, 2014), and planners had to deal with the revision of the traditional planning system, which was basically growth-oriented. Sustainability seemed to revitalise a new vision for planning through the “ecological modernisation”, according which sustainability can be achieved without impeding economic growth (Davoudi, 2000 in Hall, 2014: 463). After the initial difficulties for planners to translate into practice the sustainable development principles, spatial planning has been seen during the 1990s as crucial in tackling the environmental issue in a broad sense, including sustainable development as policy principle in national and local planning policy (Bulkeley, 2006). Sustainable development policy goals started to be translated into practice through the planning of future development of cities. Land-use planning is not only related with regulatory aspects but it contributes to the management of environmental change in localities (Healey and Shaw, 1993). Lennon & Scott (2016) described an evolutionary process of planning theory and practice related to the relationship between city and nature from a planning perspective. The need to put in relationship nature and city firstly came to the fore with the rapid industrialisation processes which has brought influential thinkers and planners to redefine an urban development models. During the 20th Century the relationship between city and nature has been analysed

through different theoretical approaches (Howard, LeCorbusier, Wright, McHarg, Mumford etc.). The introduction of sustainable development principles during the 1970s has contributed to the review of the traditional regional and urban planning assumptions. By the 1980s with the new-urbanism movement the attention shifted toward a more compact city in order to ensure a good quality of life. Green design principles started to be integrated in city planning, shifting to a new and holistic approach which “seeks to work with natural processes through promoting the sensitive use and enhancement of green infrastructure” (Lennon & Scott, 2016: 274). This new approach defined as “Socio-ecological systems” considers cities as “complex hybrid systems” functioning “at multiple interconnected spatial and temporal scales largely determined by natural processes, but frequently calibrated by society” (Lennon & Scott, 2016: 274). It shifted from a traditional position characterised for an excessive orientation to the environment protection and preservation to the ecosystem approach which also include “enhancing, restoring, creating and designing new ecological networks characterised by multi-functionality and connectivity” (Scott et al., 2016: 267). These elements remark the need to adapt urban policies, planning tools and practices -and research- for the implementation of suitable models aiming at a sustainable urban development.

2.2. The centrality of urban regeneration for the sustainable urban development

The complexity of current urban problems highlighted the need of an integrated approach able to include the social, economic and environmental perspective in a sustainable urban development perspective. Urban regeneration emerged during the last decades as suitable model for an integrated sustainable urban development. Thanks to its capability to intervene on all these dimensions, it represents the opportunity for cities to reach a Sustainable Urban Development in ensuring a smart, sustainable and inclusive growth. Urban regeneration is a widely experienced phenomenon but it is little understood and it is difficult to identify a common practice to apply in every context (Roberts & Sikes, 2000). According with Couch et al (2003: 2) “Regeneration is concerned with the regrowth of economic activity where it has been lost; the restoration of social function where there has been dysfunction, or social inclusion where there has been exclusion; and the restoration of environmental quality or ecological balance where it has been lost”. The urban regeneration concept evolved during the last 50 years in parallel with urban policies. Its focus “varied, shifting between a focus on the built environment and environmental quality (1950s and 1960s), to a social emphasis in the late 1960s, an institutional emphasis in the mid-1970s, and an economic emphasis by the late 1970s” (Healey, 2006: 98). The economic downturn at the end of 2010s increased the pressure on weak urban areas, pushing for a concrete effort of public authorities in urban regeneration based policy settings and implementation. Within the European policy context, the interest in urban regeneration for an integrated sustainable urban development emerged during the last decades. EU placed urban regeneration as central element in reaching a sustainable urban development with the Toledo Declaration (2010) that recognised its strategic potential for a smart, sustainable and inclusive growth in Europe (EU, 2010). The Declaration represents the basis for a concrete effort by Member States in defining a renovated Urban Agenda for the new Programming Period 2014-2020 and strengthening the urban dimension of Cohesion Policy. The attention of EU on Sustainable Urban Development is confirmed by the use of European Structural Funds and particularly by the European Regional Development Fund (ERDF), which allocates financial resources on integrated actions for sustainable urban development in cities (EU, 2013b). Among the EU initiative funded by the ERDF Urban Innovative Actions (UIA) play a crucial role in identifying and testing innovative solutions for sustainable urban development. One of the topic selected by UIA is about the sustainable use of land and and

nature-based solutions. The UIA together with NBS research agenda could provide the opportunity to experiment in different European cities nature based urban regeneration models. This process should be supported by local authorities through the implementation of urban policies and drawing of urban planning tools able to provide a suitable framework in re-naturing cities through nature based solutions.

3. NATURE BASED SOLUTIONS FOR CITY RE-NATURING

The interest in city re-naturing is recent and encompasses different policy areas, which focus on a conception of the city different from the “eco-city” (Lennon & Scott, 2016). This new concept is based on the adoption of nature-based solutions (NBS) finalised at the definition of a new relationship between city and nature. “Such nature-based solutions mediate the relationship between human activities and ecosystem processes in urban landscapes and, if developed appropriately, could mitigate human impact” (Haase, 2016: 279). Although the interest of academics on this topic increased recently, few definitions of nature based solutions are available and the concept has not been explored in depth (Nesshöver et al. 2017). The concept is mainly adopted by policy-makers (IUCN, 2016) with the implementation of sporadic nature based solutions at local level. The European Union has recently recognised the importance of re-naturing cities and territories with the adoption of the Research and Innovation Policy Agenda for Nature-based solutions (EC, 2015). The EU Agenda defines NBS as “actions inspired by, supported by or copied by from nature” aiming to “help societies address a variety of environmental, societal and economic challenges in sustainable ways” (EC, 2015: 24). This definition highlights the capability of nature based solutions in tackling the current challenges and trigger a more sustainable growth. Similar to the EU definition but more focused on the ecosystem approach, the International Union for Conservation of Nature and Natural Resources (IUCN) defines NBS as “actions to protect, sustainably manage and restore natural or modified ecosystems that address societal challenges effectively and adaptively, simultaneously providing human well-being and biodiversity benefits” (IUCN, 2016: 2). This definition focuses on a re-natured city concept more related to the ecosystem approach, which seeks to manage the natural environment in balancing benefits for nature and society (Nesshöver et al. 2017). Ecosystem-related approaches (ecosystem Approach, ecosystem-based Adaptation/Mitigation, Ecosystem Services Approach) mainly focus on the management of the natural environment and describe how society depends on nature. It remarks the “linkages between ecosystem structures and process functioning and consequent outcomes which lead directly or indirectly to valued human welfare benefits” (Turner and Daily, 2008: 27 in Nesshöver et al. 2017: 1218). Another definition of nature based solutions linked with the ecosystem services approach is provided by Maes and Jacobs (2015: 123): “any transition to a use of ecosystem services with decreased input of non-renewable natural capital and increased investment in renewable natural processes”. Despite the few definitions available of NBS, it is possible to identify three main typologies (IUCN (2016: 9): (i) solutions that involve making better use of existing natural or protected ecosystems; (ii) solutions based on developing sustainable management protocols and procedures for managed or restored ecosystems; (iii) solutions that involve creating new ecosystems (e.g. establishing green building)”. Eggermont et al. (2015: 245), in taking into consideration the example of greening roof and walls (3rd type) explain how these solutions alone “would hardly contribute to increase biodiversity and the delivery of other Ecosystem services” if they will be not integrated into an adequate urban planning approach at city scale. Researches and experimentations related to building energy retrofitting exploiting natural resources demonstrated how new technologies could contribute to the mitigation of environmental pressures in the built environment. This

aspect opens the debate on two important issues: the consideration of NBS in a holistic vision aiming at the valorisation of the local supply chain related to the natural element to exploit, following the ecosystems services approach; the inclusion of NBS for building energy retrofitting in a more comprehensive planning vision that should include also the social and economic aspects related to NBS. From a strictly environmental perspective it could allow the sustainable use of the natural ecosystems, their proper management and a good level of restoration of the natural capital exploited. The awareness of re-naturing cities together with the centrality of urban regeneration in reaching a smart sustainable and inclusive growth could lead toward a renovated urban development pattern characterised by nature-based urban regeneration.

3.1. The EU efforts for nature-based solutions

The EU recognised the efforts of national, regional and local policy-makers on conservation and sustainable use of the natural environment together with an increasing interest by local communities in bringing back nature into urban areas (EU, 2015). The recent EU attention on NBS as a useful element in reaching a smart, inclusive and sustainable growth, combines the need to boost economic growth and achieve sustainability (Maes & Jacobs, 2015). Particularly, the EU Horizon 2020 Research Programme “foresees large-scale pilots and demonstration projects of tangible nature-based solutions” (Maes & Jacobs, 2015: 123), which integrates the objectives and priorities of the EU Research Agenda (EC, 2015). The Agenda prepared by an expert group on “Nature-Based Solutions and Re-Naturing Cities” (EC, 2015) highlights seven research priorities and four Thematic Goals. Research Priorities are not strictly related to a specific Thematic Goal allowing the possibility of an integrated approach in defining the adoption of suitable models for re-naturing cities. This process requires particular efforts by local authorities which should consider such solutions in any urban project or strategy (EC, 2015). Urban Regeneration through nature-based solutions is one of the research priority in order to enhance sustainable urbanisation. According with the EU (2015) three are the main interconnected challenges and trends to face in providing strategic opportunities for nature based solutions for sustainable urbanisation. The first is related to economic development measures: improving sustainability in cities could bring to new business models that will empower economic growth and at the same time reduce nature resources exploitation. The second is related to sustainable urban planning with nature-based solutions in providing opportunities for the adaptation to climate change and increasing urban resilience. The third is related to the contribution of nature based solutions to the social dimension of sustainable urbanisation: the increasing of well-being conditions in the urban environment could improve the living conditions of people and reduce health risks for vulnerable groups of people. As remarked by the EU Agenda (2015), urban regeneration through nature-based solutions could help in stimulating re-naturing processes for cities due to its potential to “offers a context for innovative interventions for green growth” (EC, 2015: 16).

4. NATURE BASED URBAN REGENERATION PROPOSAL FOR THE CITY OF REGGIO CALABRIA: METHODOLOGY

The EU has recognised the need of “a more comprehensive evidence base on the social, economic and environmental effectiveness of possible nature-based solutions, including a comparison with more traditional solutions” (EU, 2015: 21). The paper methodological framework is centred on the application of nature based solution used for building energy

retrofitting through green building techniques. A comparative scenarios analysis on a small scale (building) experiment has been conducted in a central urban area of the Metropolitan City of Reggio Calabria (IT). The idea derives from the research and experimental activities held by the Università Mediterranea of Reggio Calabria (IT) in the field of Smart Specialisation Strategies (MAPS-LED Project – Horizon 2020 – Cluds Lab) and on energy building retrofitting strategies (Gevaul Lab). The first step relates to the comparison of two scenarios for the building scale experimental activity: Business as Usual (BAU) and eco-sustainable (ECO). The first is based on the application of traditional solutions. The second is based on the application of nature based solution in greening construction technique finalised at the building energy retrofitting. The results deriving from the experimental activity at building level will be then scaled up and estimated for the entire district using 3D GIS mapping techniques. The last step is to frame a nature based urban regeneration scheme consistent with the Europe Cohesion Policy objectives and applicable through local urban planning tools.

4.1. The experimental phase on building prototype

The Gevaul Lab focused on the natural properties of Cork for a possible use in green construction techniques for building ecological retrofitting. The experimental activity is based on the valorisation and use of local natural elements such as cork. Its application in greening construction techniques for walls and roofs insulation allow to consider it as nature based solution according with Eggermont et al (2015: 245). Cork is a natural element present in the regional natural landscape as well as in different areas of the Mediterranean basin. Despite it was exploited till the second half of the past century for local economic activities it has been for a long time underused. One of the most important characteristic of cork is its natural capacity to capture Carbon Dioxide. It can result crucial for the development of possible implementation in the urban environment, especially in nature-based urban regeneration interventions. The experimental phase has been conducted on a Public building within an urban block of a central neighbourhood of the City of Reggio Calabria (see Figure 1) located in the area of intervention for the proposed green district (see Figure 2a).

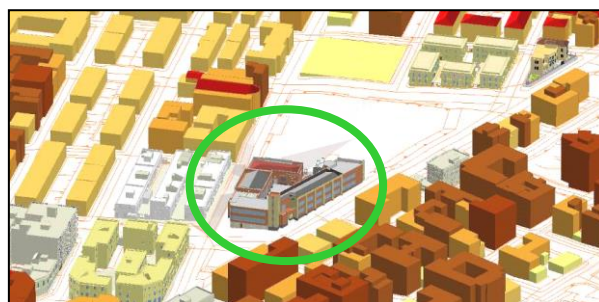

Figure 1: Reggio Calabria. Urban Block interested by experimental activity in a three-dimension GIS urban environment: a prototypical yard of sustainability

The building has a particular institutional relevance because it houses an important public authority: The Regional Administrative Court House (TAR). Ecological retrofitting transforms ordinary maintenance into an opportunity for building energy efficiency. Through the comparison of a Business as Usual (BAU) scenario characterized by the use of traditional materials and an Eco-Sustainable scenario (characterised by the use of cork panels for roof insulation and walls passivation) it has been possible to estimate the economic (initial maintenance costs) and environmental (global energy performance index) benefits deriving from the application of this greening building technique (see Table 1). The "Eco-sustainable"

scenario is characterized by the adoption of natural thermal insulating hydraulic lime plaster, natural cork fitted with a funnel that produces the dual function of both thermo-insulation and ventilation in order to eliminate thermal bridges and avoid over heating in summer, the air conditioning system with indoor units and the installation of condensing boiler. The application of these materials determines an effective dynamic thermo-hygrometric and, in particular, summer perspiration reducing the discomfort of humidity (moisture) which triggers the need for cooling in summer and the massive demand for air conditioning.

Table 1: Reggio Calabria. Urban Block #128 Total costs for the two intervention scenarios Special work for the specific building (Regional Administrative Court House). Related Pay Back period

	BAU Scenario	Eco Sustainable Scenario	Q	Tot costs BAU	Tot costs ECO Sustainable	D
Interventions	€/sqm	€/sqm	sqm	€	€	%
Plaster renovation	60	80	2.675	160.500	214.000	33%
Windows replacement	400	500	554	221.600	277.000	25%
Pitched roof renovation	130	180	505	65.650	90.900	38%
Flat roof renovation	105	140	500	52.500	70.000	33%
Total amount				500.250	651.900	30%

The initial cost for the "Eco-sustainable" scenario is higher (+30% see Table 2) than in the "business as usual" due to the use of bio-ecological materials with higher quality and durability, and the most efficient climate system. It follows lower costs of ordinary and extraordinary maintenance and a cut in energy management costs. Eco sustainable retrofitting to the urban scale must be driven not only by the initial costs, but also by the management and maintenance costs during building life cycle. In this perspective energy savings is taken into consideration as a parameter for the estimation of environmental and economic advantages. Global Energy Performance Index (EPGI) has been calculated to estimate energy savings on the examined building. Once obtained data on energy consumptions (heating and cooling), it was possible to estimate the management costs for the two alternative scenarios assuming the average cost of € 0,115/kWh (thermal) and € 0,195/kWh (cooling) (see Table 2).

Table 2: Reggio Calabria. Urban Block #128 EPGI for the BAU scenario.

	EPGI	Net area	EPGI Tot	Energy cost	Management cost
	kWh/sqm	sqm	kWh/year	€/kWh	€
Heating	142	1.300	184.600	0,115	21.229,00
Cooling	102	1.300	132.600	0,195	25.857,00
Total			317.200		47.086,00

The "Eco-sustainable" scenario achieves an energy annual savings of € 27.157,00 in terms of management costs in the life cycle. This differential of less 57 per cent compared to the annual theoretical management costs of the "business as usual" scenario, can be added as cost saving (see Table 3). Payback of additional costs for Building Sustainable Retrofitting (differentiated from Business As Usual Retrofitting) can be assessed (at 4% Hurdle Rate) in 6 years.

Table 3: Reggio Calabria. Urban Block #128 EPGL for the eco-sustainable scenario

	EPGL	Net area	EPGL Tot	Energy cost	Management cost
	kWh/sqm	sqm	kWh/year	€/kWh	€
Heating	57	1.300	74.100	0,115	8.521,00
Cooling	45	1.300	58.500	0,195	11.407,00
Total			132.600		19.929,00

An estimate of the overall cost provides in the medium-long term an obvious convenience of the "eco-sustainable" scenario not only in terms of maintenance interventions, energy consumption, pollution abatement, indoor quality and general environmental protection, but also a better financial result. In addition to significant energy savings it is also possible to get high health, lower environmental impact and reduction of CO2 emissions into the atmosphere. Knowing therefore also the energy dynamics of a building system allows to identify those choices aimed both at the improvement of the energy efficiency and to the reduction of environmental impacts. At this stage the application of GIS techniques allow to compare quickly the data for alternative scenarios.

4.2. The scaling up phase at district level

At this point a generalization from the building to the district level has been performed for the case study area (Massimo, 2009; Massimo, 2015; Massimo et al. 2016). It is located in a central neighbourhood of the city of Reggio Calabria. The majority of the built environment was rebuilt at the beginning of 1900 as an interesting Liberty – Art Nouveau settlement (see Figure 2a). The eco-sustainable Scenario based on natural cork system is conservative and high energy efficient. Its design adopts, at building level, ecological techniques and materials to reduce heat dispersion toward the outdoor as well as to cut fossil fuels consumption for heating and conditioning and consequently to lower related CO2 emissions. The neighbourhood has been mapped into a 3D valuation GIS (see Figure 2b) giving the relevant extension of: 490.000 sq.m of district total area; 125 urban blocks; 840 buildings covering a built-up area of 208.000 sq.m with 2.500.000 cu.m of built volume; 800.000 sq.m of apartments; over 400.000 sq.m of fronts to be insulated; about 180.000 sq.m of roofs to be aerated-ventilated and insulated; a population of 6.400 residents, plus thousands of University Students living temporarily in the area as tenants.

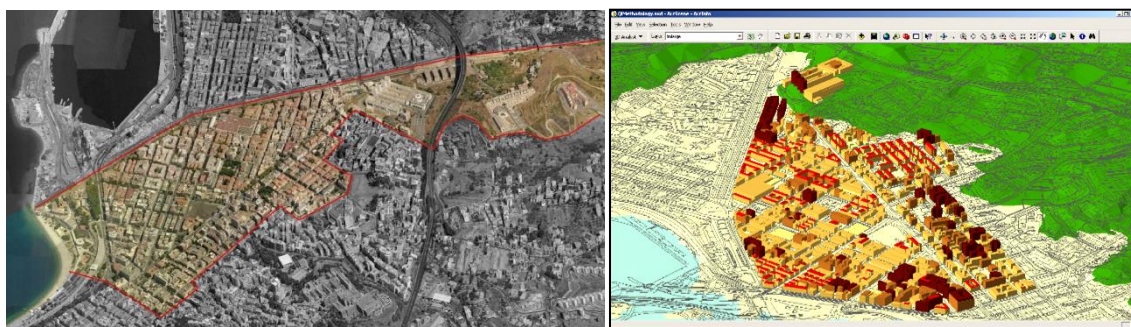

Figure 2: Reggio Calabria. Case study area (a); Urban scale 3D case study area model (b)

BIO Urban Sustainability works have been designed and valued in their environmental and energy impacts. As the prototype experimentation on building has showed, natural insulation and ventilation reduce the needs and energy consumption for winter heating as well as for more

demanding air conditioning during summer. Relevant is also the amount of avoided Kg of CO₂. Data on building typologies, size and architectural characteristics have been gathered and mapped through GIS technique in order to estimate the potential benefits in a scaling up phase at district level. The use of GIS tools makes possible automatic assessment for the entire case study area. The variables taken into account in comparing a BAU and ECO sustainable scenario are: total monetary initial (investment) cost of works; energy consumption, total annual running costs, CO₂ emission per year (see Table 4). The positive results achieved (see Table 4) give two empirical positive evidences: physical in terms of energy saving thanks to sustainable bio-ecological materials employed; economic with a short period of pay-back of the “initial cost monetary negative premium”.

Table 4: Reggio Calabria. Scaling up phase (district) potential benefits through building energy retrofitting

		BAU	Sustainable	D	D
		x 1000	x 1000	x 1000	%
Investment work cost	€	64.400	85.600	+21.200	+ 24
Energy needs per Year	kWh	83.000	50.000	- 33.000	- 40
Management costs per Year	€	12.450	7.500	- 4.950	- 40
CO ₂ emission per Year	kg	16.000	9.500	- 6.500	- 40

Research, field work, on field observations, as well as specific experimentations performed on the sample prototypal buildings assuming an intervention of sustainable energy rehabilitation, have highlighted an average reduction of 40% of the theoretical amount of energy needed as well as a reduction of the 40% of management costs per year. The consequent monetary amount of year energy saving is of € 4.950.000,00. Considering a total saving of passivation equal to € 4.950.000 per year the correspondent payback at steady rate of 4% (Hurdle Rate) can be assessed in about **6** years. In a period of 8 years, adopting a medium-high discount rate of 4% the extra initial cost of “eco-sustainable” scenario (Nature-Based on Cork) is recovered. In a period of 20 years the 50 per cent of the total initial cost is recovered. An astonishing result if summed up with environmental and energy positive outcomes, not taking into consideration the relevant direct environmental benefits (40% of CO₂ emission reduction). These empirical evidences encourage to follow the path of Sustainable Urban Conservation at larger scale and to apply the methodology in other prototype buildings and in different climate zones.

4.3. Hypothesis of nature based urban regeneration for the city of Reggio Calabria: integration between policy opportunity and local urban planning tools

Although the EU interest in nature-based solutions is currently focused on research priorities, the Cohesion Policy for the programming period 2014 allow to explore interesting possibilities for the application of nature-based solutions in cities. First of all, the need to re-nature cities cannot disregard innovation. It is one of the EU Research Agenda about nature based solutions (EU, 2015). It is also a central element in EU Cohesion Policy thank to the adoption of Smart Specialisation Strategies (S3). The S3 approach focuses on specific innovation-intensive sectors aiming at transforming regional economies on new or existing knowledge-based domains (EC, 2013a). The S3 process, which need to be translated into Regional Plans (RIS3) can help in the identification of those local potentials that innovation can trigger in order to discover new market opportunities and domains. The Calabria Region RIS3 plan has selected

the greening building areas as one of the strategic trajectories of the regional innovation strategy (RIS3). The valorisation of natural resources in the building construction technique in order to boost sustainability, empower the local economy and enhance the wellbeing of people if one of the key points. The main issue is related on how integrate these ideas into the traditional local urban planning tools in accordance with the European, national and local (regional) policies in boosting a smart, inclusive and sustainable growth.

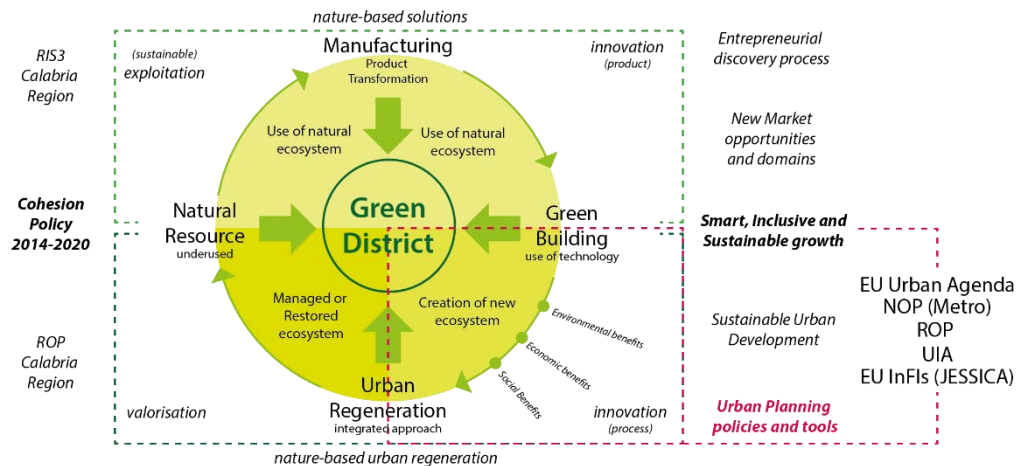

Figure 3: Green District through nature-based urban regeneration in the S3 perspective

At local level (city) the Italian planning system give relevance to the general comprehensive plan. It has both a land-use regulatory function and the capacity to select the general future development trajectories of the territory and development guidelines for each district. The general plan (city) functioning needs the implementation of executive urban plans for each specific district. It is here that urban renewal or redevelopment programs/plans have to be applied. We argued, as highlighted in figure 3, that from the integration between European, national and local policies with the local urban planning tools implementation it is possible to enhance sustainable urbanisation process through nature based urban regeneration. This process requires the proactive involvement of research institutions as well as public authorities, businesses and local communities. Land-use regulations and design guidelines need to be updated both in terms of integration of uses within the district and in terms of the possible use of nature based solutions. Another important aspect to take in consideration relates to how to fund these initiatives. Funds could derive from the integration of different sources: direct EU funds, National Operative Programs (PON Metro), Regional Operative Programs, EU financial instruments, national and local resources and the private sector. The experimentation at district level of a nature based urban regeneration scheme could allow the creation of an innovative urban ecosystem stimulating a sustainable and equitable growth. These processes will improve the urban quality of life, contribute to the reduction of Co2 emission allowing also money savings for owners and create jobs through the valorisation of the cork-related local supply chain.

5. CONCLUSION

The paper focused on the possibility to introduce nature-based solutions urban regeneration finalised at the realisation of a green district in a central neighbourhood of the Metropolitan City of Reggio Calabria (IT). We argued that urban regeneration can play a central role in tackling current urban problems for an integrated sustainable urban development. As

highlighted by the literature, different theories about the relationship between city and nature has been developed by influential thinkers and planners. The current interest in city-re-naturing pushed toward the introduction of nature based urban regeneration, with the aim to reduce the environmental pressures in the urban environment. For the EU, nature based urban regeneration is a key element in reaching sustainable urbanization processes, and building energy retrofitting through nature based solutions – i.e. greening walls and roofs – is considered as an element to increase sustainability in the urban environment. The “building scale” experimental activity conducted in a central neighbourhood of the city of Reggio Calabria, has shown the benefits deriving from the application of nature-based solutions in greening buildings energy retrofitting. The comparative analysis scenario conducted reveals how the application of the described techniques at district level will reduce CO2 emissions and generate economic savings for owners. The scaling up phase at district scale need to be framed within the existing economic development and urban planning tools through suitable nature based urban regeneration initiatives. “This integrated approach defines new ways of thinking in producing new responsive scenarios to the social, economic and territorial demand of transformation” (Bevilacqua & Pizzimenti, 2016: 918). In order to maximise positive impacts nature based urban regeneration needs to take into account innovation (production and use) as cross element for all the dimensions involved -social, economical and environmental- in order to create an innovative ecosystem. In this perspective, the S3 approach, deepened with the MAPS-LED project, allow to exploit the potential of local economic areas both at district and at the local supply chain level. Nature-based solutions in urban regeneration interventions can stimulate the application of innovative solutions finalised at the valorisation of local supply chains of natural resources locally available stimulating the Entrepreneurial Discovery Process and reinforcing local economy in creating new market opportunities. Furthermore, the possibility to use the Innovative Financial Instruments (InFIs) such as JESSICA, or to experiment EU Urban Innovative Actions –integrating local urban planning tools- can multiply the positive effects of investments and generate returns that can be used for the improvement of public services. The economic evaluation and the feasibility of the green district model presented will be investigated in further studies in order to propose it for a concrete implementation.

6. ACKNOWLEDGEMENTS



The MAPS-LED project has received funding from the European Union’s Horizon 2020 research and innovation programme under the Marie Skłodowska-Curie grant agreement No 645651.

7. REFERENCES

- Bai X., Nath I., Capon A., Hasan N., Jaron D., (2012) *Health and wellbeing in the changing urban environment: complex challenges, scientific responses, and the way forward*, Current Opinion and Environmental Sustainability vol. 4, p. 465-472
- Bevilacqua C. (2012), *Economic Development Strategies 'The Role of Public Private Partnership' - First Scientific Report*, CLUDS Project, 7FP Marie Curie Irises P.R. 269142
- Bevilacqua C., Trillo C. (2012), *Economic Development Strategies 'The Role of Public Private Partnership' - First Scientific Report*, CLUDS Project, 7FP Marie Curie Irises P.R. 269142
- Bevilacqua C., Pizzimenti P, (2016), *Living Lab and Cities as Smart Specialisation Strategies Engine*, Procedia: Social & Behavioral Sciences, vol. 222, p. 915-922, ISSN: 1877-0428, doi: 10.1016/j.sbspro.2016.05.315
- Bulkeley H. (2006), *A Changing Climate for Spatial Planning*, Planning Theory & Practice, vol. 7, no. 2, p. 201–230.
- Couch C., Fraser C., Percy S., (2003), *Urban Regeneration in Europe*, Oxford, Blackwell Science

- European Commission (2009), *Promoting Urban Sustainable Development in Europe. Achievements and Opportunities*. European Commission, Directorate-General for Regional Policy
- European Commission (2013), *The role of clusters in smart specialisation strategies*, European Commission, Directorate General for Research and Innovation
- European Commission (2013), *Regulation (EU) No 1301/2013 of the European Parliament and of the Council of 17 December 2013 on the European Regional Development Fund and on specific provisions concerning the Investment for growth and jobs goal and repealing Regulation (EC) No. 1080/2006*
- European Commission (2014), *Integrated Sustainable Urban Development Factsheet*, European Commission, Regional Policy, available at http://ec.europa.eu/regional_policy/sources/docgener/informat/2014/urban_en.pdf
- European Commission (2015). *Towards an EU Research and Innovation policy agenda for Nature-Based Solutions & Re-Naturing Cities*, Directorate-General for Research and Innovation 2015 Climate Action, Environment, Resource Efficiency and Raw Materials EN (full version)
- European Investment Bank (2017), *European Financial Instruments*, available at <http://www.eib.europa.eu/products/index.htm>, accessed April 2017
- Florida R., Adler P., Mellander C. (2017), *The city as innovation machine*, *Regional Studies*, Vol. 51 no. 1, p. 86-96, doi: 10.1080/00343404.2016.1255324
- Eggermont H., Balian E., Azevedo J. M. N., Beumer V., Brodin T., Claudet J., Fady B., Grube M., Keune H., Lamarqu P., Reuter K., Smith M., Van Ham C., Weisser W. W., Le Roux X., (2015), *Nature-based Solutions: New Influence for Environmental Management and Research in Europe*. GAIA – Ecological Perspective for Science and Society, Vol. 24, no. 4, p. 243-248
- Hall P., (2014), *City of Tomorrow*, Oxford, Wiley Blackwell, 1988 (4th ed.)
- Healey P., Shaw T. (1993), *The Treatment of Environment by planners: evolving concepts and policies in development plans*, Electronic Working Paper No 4, School of Architecture, Planning & Landscape Global Urban Research Unit University of Newcastle upon Tyne.
- Healey P (2006), *Urban Regeneration and the Development Industry*, *Regional Studies*, Vol. 25, no. 2, p. 97-110
- Haase D. (2016), *Reflections on urban landscapes, ecosystems services and nature-based solutions in cities*, *Planning Theory & Practice*, Vol. 17, no. 2, p. 276–280, DOI: 10.1080/14649357.2016.1158907
- IUCN (2016). *Nature-based Solutions to address global societal challenges*. International Union for Conservation of Nature and Natural Resources, Gland, Switzerland: IUCN.
- Lennon M., Scott M. (2016), *Re-naturing the City*, *Planning Theory & Practice*, Vol. 17, no. 2, p. 270–276, DOI: 10.1080/14649357.2016.1158907
- Maes J., Jacobs S. (2015), *Nature-Based Solutions for Europe's Sustainable Development*, *Conservation Letters*, A journal of the Society for Conservation Biology, Vol. 10, no. 1, p. 121-124
- Massimo D. E. (2009) Valuation of Urban Sustainability and Building Energy Efficiency. A Case Study. *International Journal of Sustainable Development*. Vol 12, Nos. 2-3-4: pp. 223-247. ISSN: 0960-1406. DOI: 10.1504/IJSD.2009.032779. S: 2-s2.0-77953970310
- Massimo D. E. (2015) Green Building: Characteristics, Energy Implication and Environmental Impacts. Case Study in Reggio Calabria, Italy. In: Mildred Coleman-Sanders, *Green Building and Phase Change Materials: Characteristics, Energy Implications and Environmental Impacts*. Nova Science Publishers, Inc. New York. Pages 71-101. ISBN: 978-163482749-2; 978-163482702-7. S: 2-s2.0-84955731984
- Massimo D. E., Fragomeni C., Malerba A., Musolino M. (2016) Green District. Case Study in Reggio Calabria. *New Dist. Special Issue. SBE16 Post-Carbon Cities*. Pages 425-434. ISSN:2283-8791 .
- Nesshöver C., Assmuth T., Irvine K. N., Rusch G. M., Waylenf K. A., Delbaere B., Haase D., Jones-Walters L., Keune H., Kovacs E., Krauze K., Külvik M., Rey F, Van Dijk J., Vistad O. I., Wilkinson M. E., Wittmer H. (2017), *The science, policy and practice of nature-based solutions: An interdisciplinary perspective*, *Science of the Total Environment* 579, p.1215–1227
- Roberts P., Sykes H., Granger R. (2016), *Urban Regeneration*, Sage, London
- Roberts P., Sykes H. (2000), *Urban Regeneration. A Handbook*, Sage, London
- Scott M., Lennon M., (2016), *Nature-based solutions for the contemporary city*, *Planning Theory & Practice* Vol. 17, no. 2, p. 267–270, DOI: 10.1080/14649357.2016.1158907
- United Nations (2014), *World Urbanization Prospects: The 2014 Revision, Highlights*, United Nations, Department of Economic and Social Affairs, Population Division
- Zeng H. W., Shen G., Q., Wang H., (2014), *A review of recent studies on sustainable urban renewal*, *Habitat International* Vol. 41, p. 272-279

TOWARDS IMPLEMENTING S3.CURRENT DYNAMICS AND OBSTACLES IN THE LAZIO REGION

A. L. Palazzo¹ and K. Lelo²

¹ Department of Architecture, Roma Tre University of Rome, Via Madonna dei Monti, 40, 00184 Roma, Italy

² Department of Economics, Roma Tre University of Rome, Via Silvio d'Amico, 77, 00145 Roma, Italy

Email: annalaura.palazzo@uniroma3.it

Abstract: The Lazio Region is carrying out a re-industrialization policy following the Europe 2020 targets for economic growth, known as Smart Specialization Strategy (S3). This paper frames industrial policy settings dating back to the second half of the 20th Century in the light of current processes and institutional efforts to set a new season for Industry in Lazio Region. Subsequently, relying upon demographic and socio-economic dynamics over the last two decades, new features in settlement patterns and sector-specific obstacles to sustainable development are addressed with a major focus on the Metropolitan area of Rome (the former Province of Rome). In conclusion, some remarks are drawn mindful of the new globalization wave affecting 'supply chains' of goods and business services from all over the world, of current trends and innovative approaches liable to envisage 'territory' as an opportunity rather than a cost. Difficulties in making different opinions to converge are evident. The proper ground to make it happen should be prepared by a governance able to support place-based inherent 'entrepreneurial discovery processes', while providing negotiating practices framed by general and sectoral policies, and communication approaches to ensure transparency and participation of public at large.

Keywords: Lazio Region, Metropolitan Area, S3, Settlement Patterns, Sustainability Scenarios, Territorial Innovation

1. INTRODUCTION

The Lazio Region accounts for 1.4% of the European GDP and 11.5% of the Italian one. Investments in consumer goods still play a major role (almost 30%), while the production function totals nearly 20% both in terms of capital and new jobs (Crescenzi *et alii*, 2016). Current regional dynamics give rise to differing interpretations.

The first one points out that on-going metropolization processes are shaping new relationships between the Capital City and its wider hinterland, determining a City-Region pattern. Among the 40 Italian municipalities with highest percentage growth between 1991 and 2011, 12 belong to the Province of Rome: Fiumicino, Ardea, Ladispoli, Cerveteri, Anzio, Pomezia, Guidonia Montecelio, Aprilia, Monterotondo, Nettuno, Albano Laziale, Velletri, with an average growth of 25% (Fig. 1). All municipalities fall within a population range deemed scale-efficient (between 30,000 and 80,000 inhabitants), providing good integration level in terms of labor market while avoiding urban congestion (Istituto Nazionale di Urbanistica, 2011).

The second, opposite, interpretation shows evidence about a still prevailing centripetal pattern, tied to the strong appeal of a core area slightly wider than the historic center of Rome: as a matter of fact, 83% of foreign capital invested between 2003 and 2014, and 93% of all new jobs in Lazio, have Rome as their destination (Crescenzi *et alii*, 2016).

The third interpretation investigates current redeployment processes and the rise in higher added value sectors, notably innovative services, currently supported by new regional policies (Smart Specialization Strategies), underlining high-tech manufacturing activities historically present in excellence sub-regional production areas. Whether these emerging arrangements between sub-regional areas are likely to reciprocally exchange goods and people and even enter foreign markets in partial or total autonomy from the lure of Rome is a matter of debate (CER-Unindustria, 2012).

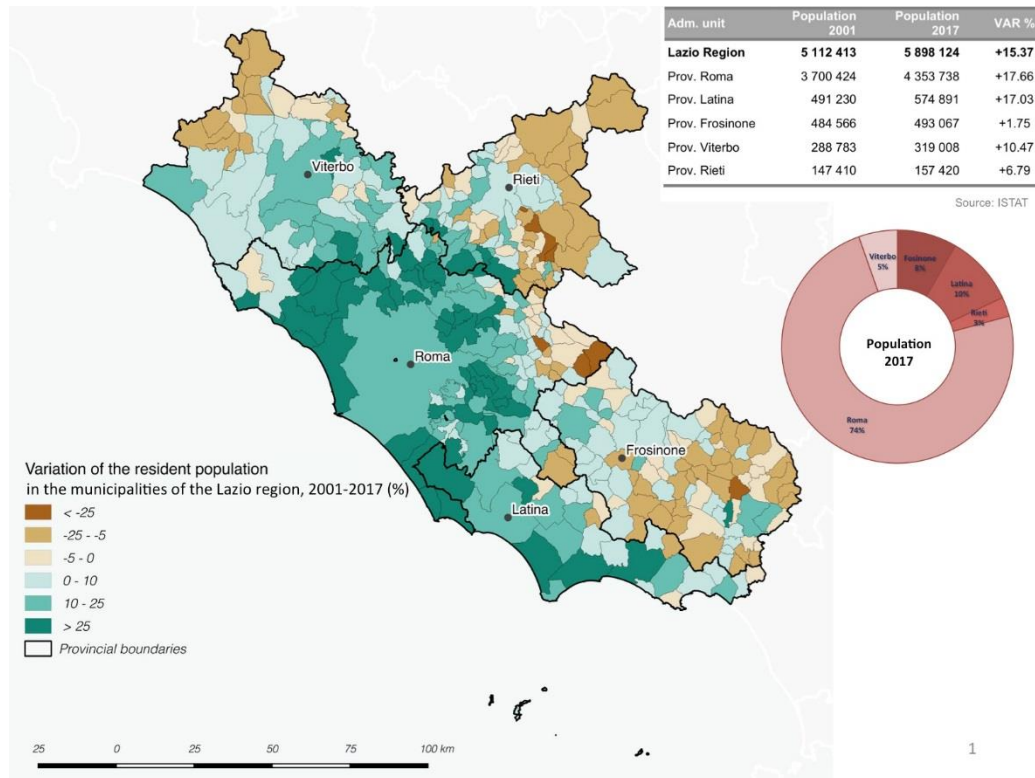

Figure 1: Variation of the resident population in the Lazio Region 2001--2017
Source: Processing of the Authors based on Istat data

On the backdrop of such controversial trend scenarios, this paper intends to address some major issues related to emerging production features and patterns related to the S3 strategy. In the light of new globalization affecting ‘supply chains’ of goods and services from all over the world, does proximity still matter, and, if that is the case, what kind of governance can address both place-specific needs and sector-specific obstacles?

2. DELIBERATE OR UNINTENTIONAL GEOGRAPHIES?

The three industrial revolutions of the past were triggered by technical innovations: the introduction of water and steam-powered mechanical manufacturing at the end of the 18th Century, the division of labor at the beginning of the 20th century and introduction of programmable logic controllers for automation purposes in manufacturing in the 1970s. The upcoming industrial revolution is being triggered by the telematics undermining previous location factors, scattering production processes or incorporating them within urban areas. All these issues, place-based and scale-dependent, are crucial for outlining sustainability paths.

Due to a defective modernization in the 20th Century and to specific industrial patterns, the Lazio Region has somehow been spared from drastic workforce reduction at the end of the 'second revolution'. Conversely, since the early 80s, it has known remarkable diffusion and relocation phenomena, due to production and service activities restructuring - small size businesses have always been the majority -, with no significant consequences in employment rates. Centrifugal trends led SME to accommodate randomly, even though at the initiative of single municipalities industrial estates had been identified within local plans.

Such fragmentation, which proves ineffective both for sector-specific strategies and for the territories, due to general lack in accessibility, high environmental costs, etc., is actually a major concern. The governance system has little influence over these phenomena. It is sufficient to think of soil consumption, notably in the Metropolitan area of Rome (the former Province), which alone touches 71,000 hectares, increasing by 500 hectares between 2012 and 2015 at the expense of agricultural land (Ispra, 2016).

As a matter of fact, the Lazio Region has long been suffering a discrepancy between the 'Ideal region' as it had been envisaged by planners and decision makers, and the 'Real one', resulting both of voluntary and unintentional actions. Top-down and bottom-up processes have been heavily shaping the geographical distribution of assets and facilities. After a phase spurred by the National agency 'Cassa per il Mezzogiorno' concerning location strategies for five major equipped industrial areas (1950s-1980s), the second phase initiated by the Lazio Region since its establishment was far less effective. The new leadership avoided making commitments apart from issuing scant requirements to specialized clusters eligible for subsidies (Regional Law 36/2001). On such occasion, 'districts' and 'local production systems' were identified characterized by different typologies of specialized production (Fig. 2a). These restrictions aiming at targeting incentives in areas with a strictly productive vocation intercept only the 25% of the regional total, corresponding to an occupational capacity of 84,000 employees. As a matter of fact, production homogeneity is not a key feature of the regional industrial structure, which actually presents weak location quotient apart from the pharmaceutical district, the paper and the ceramic one.

Meanwhile, at the initiative of single municipalities, industrial estates have been identified within local plans, generally appealing to small businesses (Fig. 2b).

In turn, provincial planning guidelines accommodating new inter-municipal areas for technopoles and specialized industrial estates have come into force in the 2000s, but they have not been implemented as yet, due to persistent segmentation and lack of communication between programming and implementing at the local level. Moreover, whereas 'Roma Città Metropolitana' has been recently settled by law in the place of the Province of Rome (Law 56/2014), its budget has been shortened by 9/10.

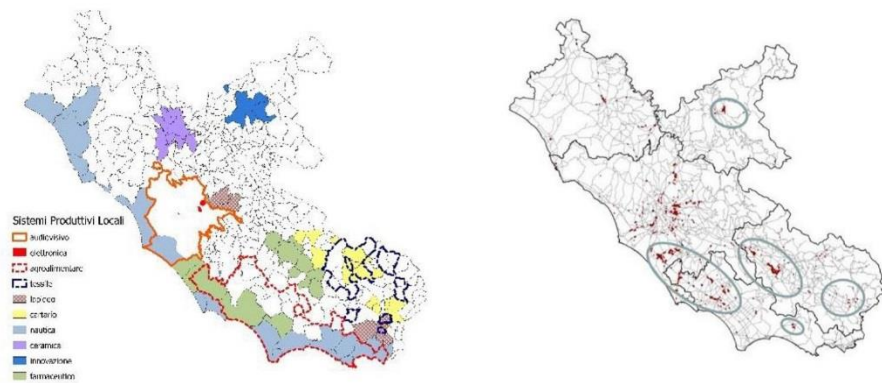

Figure 2: Production systems in Lazio.

2a) Local Production Systems and Districts (Lazio Region, 2001).

2b) Overlap between industrial development consortia identified by the State in the 1950s (Cassa per il Mezzogiorno) and industrial zoning implemented by single municipalities (2006). Credits: Authors' processing from data of Lazio Region.

3. CURRENT DYNAMICS

A research report dating back to 2010 identifies in the Lazio Region 13 'local productive poles' devoted to manufacturing, wholesale trade, hi-tech productions (software, computer services, audiovisual, telecommunications), transport and logistics (Fig. 3, Table 1).

PRODUCTION POLES

1. CIVITA CASTELLANA E VITERBO; 2. RIETI-CITTADUCALE; 3. FIANO ROMANO-FORMELLO; 4. LITORALE NORD (CIVITAVECCHIA-FIUMICINO); 5. BRETELLA NORD (TIVOLI-GUIDONIA); 6. BRETELLA SUD (VALMONTONE-COLLEFERRO); 7. CASTELLI ROMANI; 8. POMEZIA-SANTA PALOMBA; 9. FROSINONE-SORA; 10. LATINA-CISTERNA; 11. CASSINO; 12. SUD PONTINO (FORMIA-GAETA); 13. ROMA

THE DRIVERS OF POLARIZATION

SPONTANEITY (AGRI-FOOD, NAUTICAL)
 EXPANDING METROPOLITAN AREA PROCESS (WHOLESALE, LOGISTICS, AUDIO VISUAL)
 LARGE COMPANIES (MECHANICS, ELECTRONICS, AEROSPACE, PHARMACEUTICALS)
 SYSTEM-BASED ACTIONS (ICT, HI TECH)

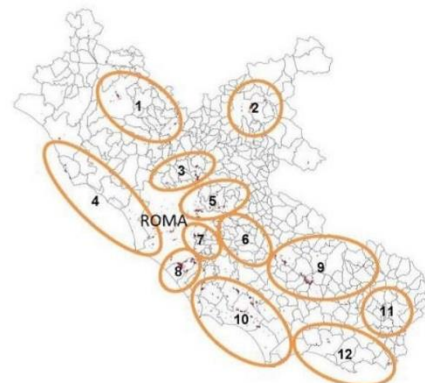

Figure 3: Production Poles. Credits: Unioncamere Lazio, Censis (2010).

Table 1. Industrial employment in the Lazio Poles (2010)

EMPLOYMENT BY POLES	PRODUCTION POLES
≈ 85.000	COMUNE DI ROMA
≈ 20.000	POMEZIA-SANTA PALOMBA, LATINA, FROSINONE
≈ 6.000 – 7.000	VITERBO-CIVITA CASTELLANA, CASTELLI, LITORALE NORD, BRETELLA NORD
≈ 3.500 – 4.500	CASSINO, RIETI-CITTADUCALE, BRETELLA SUD, SUD PONTINO
≈ 1.500	FIANO ROMANO-FORMELLO

This survey is highly representative of the regional dynamics, since it intercepts municipalities gathering 87% of the overall population and 92% of total employment and

sets forth trend lines that would not be detectable by the concentration indicators adopted by the Lazio Region for ‘Local Production Systems’ and ‘Districts’ /see Fig. 2).

Overall, these ‘dynamic poles’ total 28.3% of the regional added value closely following financial and real estate brokerage activities (29%) and preceding basic social and health services: public administration, health, education and personal services totaling 25.7%.

Summarizing, four major driving forces are at work selectively affecting industrial sectors: Spontaneity (which is typical to agrifood, nautical and industry); Expansion of the metropolitan area (wholesale, logistic); Bigger players (mechanics, electronics, aerospace, biotechnology and pharmaceuticals); System’s actions (ICT, hi-tech, biotechnology and pharmaceuticals).

In general, the major manufacturing chains unveil lack of specialization, a ‘non-district’ nature and some connections between different production areas which need to be clarified, as it can be inferred in the cases where industrial employment has a larger share.

These productive poles can be considered ‘transversal territorial networks’, ‘multifaceted structures’, often very flexible, mainly due to the substantial presence of craft industries. Their ‘birth’ is not due to imitation or direct filiation of successful businesses in a given sector in a specific location characterized by extensive sub-supply networks, but instead from space arrangements aimed at accommodating diverse and diversified productive settlements. These are usually inter-municipal areas equipped with major facilities: infrastructure, water purification networks, lighting, security, broadband.

It is no coincidence that such ‘hubs’ tend to be managed by a sort of ‘control room’. Sometimes this governance is entrusted to institutional entities, such as consortiums in charge of ‘industrial development areas’ (*Aree di sviluppo industriale*, ASI, deriving from the ‘Cassa per il Mezzogiorno’ experience), while in other cases they are directly managed by the companies operating through independent consortia.

Sometimes, affinities between economic activities are to be sought on the ground of proximity according to the motto of ‘doing different things for the same purpose’, that is enhancing cross-sectoral research and innovation strategies conveying most innovative manufacturing, advanced business services, applied scientific research.

Except for the Civita Castellana ceramic district, coexistence of various manufacturing specialties is the rule. In the Hi-Tech and ICT sectors, the increasing polarization of Formello demonstrates an extension of the sector from the districts of Prati and Saxa Rubra in the Municipality of Rome. As for transport and logistics, the weight of the coast North of Rome from Civitavecchia to Fiumicino is emerging although this sector is also present along the axis connecting Pomezia to Latina, the axis between Monterotondo and Guidonia Montecelio, and in the Frosinone and Ferentino area. Finally, wholesale trade is widespread everywhere around Rome, but the role of the Pontina area South of Rome stands out, thanks to the biggest market of fruit and vegetable in Fondi. The Latina hub proved a major sector in the agro-industry (with numerous companies, especially in Pontinia, Sezze and Priverno), as well as in instrumental mechanics (Latina) and in the nautical sector (especially between Terracina and San Felice Circeo). The pole of Pomezia-Santa Palomba remained leader in the pharmaceutical and biomedical fields: Pomezia alone gathered in 2012 18.5% of all firms present in the region, with significant specialization features both

in chemistry and plastics industry (9.8%) as well as in instrumental mechanics (6.4%). The area of Frosinone confirmed itself as the first regional pole in the field of chemistry and plastics, complemented with a number of other specializations, among which paper industry.

Effective and innovative system-based actions are the result of careful public-private partnerships benefiting the most value-added and high tech industries: hi-tech and ICT, software production and audiovisual productions, or the biotechnology sector. In all these areas, close synergies have been set up between companies, scientific research and public institutions.

Undoubtedly, this interpretation of the productive reality within the Lazio region is the best fitting one. Yet, it is undergoing new challenges. So far, despite the need to fulfill the principles of cooperation and concentration in so-called ‘technopoles’ and ‘parks of activities’ provided by district-scale planning, the sphere of production and that of policy-makers have not been able to streamline innovation processes. The main obstacles are to be found in deep-rooted mistrust from local authorities towards selective solutions; in municipal reluctance towards inter-institutional cooperation (including common agreements); in the absence of incentives for restructuring productive activities, with social, economic and environmental spill-over effects.

4. OLD MATTERS AND NEW CONCERNS

In 2013, ‘Europe 2020’ was set forth in order to support strategic sectors (Common Strategic Framework 2014-2020 and Guidelines for the efficient use of financial resources for the 2014-2020 development). Notably, the S3, acronym for Research and Innovation Smart Specialization Strategy, is conceived to lead the EU towards a more intelligent, sustainable and inclusive economy. The main objectives of this initiative are to help the Member States to: (i) Improve their productivity; (ii) Achieve higher employment rates; (iii) Enhance social cohesion.

In the so-called ‘entrepreneurial discovery process’, a main effort was to be devoted to acknowledge and support local tangible and intangible assets: not only goods, but also relationships, values, knowledge, and the natural and institutional environment liable to give continuity and new perspective to development.

Accordingly, the document ‘Smart Specialization Strategy’ approved by the Regional Council in July 2014 envisages seven macro sectors as the main pivots for forthcoming regional policies: Aerospace; Agri-food; Audiovisual and Creativity; Green Economy; Life Sciences; Cultural Heritage and Technologies for Culture; Safety (Table 2).

As a result, during the General States of Industry (February 2016), 173 projects were presented by hundreds of players, such as large enterprises, SMEs, universities, research centers, associations and local authorities subjects, for a total of 2.3 billion potential investment.

The Lazio Region is committed to invest 100 million Euros for enabling businesses to compete more effectively on the global market; 3 million for redevelopment of brownfield sites; 28 million for Ecologically Equipped Productive Areas (APEA) and related

infrastructure; 30 million for the internationalization; 20 million for supporting the transformation of creative ideas into business ventures.

Apart from deep-rooted sectors settled in specific areas (Aerospace, Life Sciences, and somehow ICT), the other ‘specialization areas’ are seldom physical concentrations featured by high intensity relationships among related enterprises: they are not clusters in the sense of Porter’s definition. Most often, these sectors are dispersed, and as such they need to be better connected. Networks between SMEs, large holdings and multinational companies prove essential both for technology-intensive sectors, such as aerospace, electronics or pharmaceuticals (such sector is the first export sector, accounting for 36% of the regional total), and for others, such as tourism, fashion, design.

Table 2. Features of the S3 Strategy in the Lazio Region

LAZIO DESCRIPTION	CAPABILITIES	TARGET MARKETS	EU PRIORITIES
CREATIVE INDUSTRIES	CREATIVE, CULTURAL ARTS & ENTERTAINMENT LIBRARIES, ARCHIVES, MUSEUMS & OTHER CULTURAL ACTIVITIES	CREATIVE, CULTURAL ARTS & ENTERTAINMENT	CULTURAL & CREATIVE INDUSTRIES
GREEN ECONOMY - SEEN AS A SECTOR IMPORTANT FOR SEVERAL ASPECTS, RANGING FROM TRANSPORT TO ENERGY GENERATION	ENERGY PRODUCTION & DISTRIBUTION		SUSTAINABLE INNOVATION ECO-INNOVATIONS
LIFE SCIENCES	BIOTECHNOLOGY	HUMAN HEALTH & SOCIAL WORK ACTIVITIES HUMAN HEALTH ACTIVITIES (MEDICAL SERVICES)	PUBLIC HEALTH & SECURITY PUBLIC HEALTH & WELL-BEING
AEROSPACE	AIR TRANSPORT & RELATED SERVICES		AERONAUTICS & SPACE AERONAUTICS
SAFETY & SECURITY - UNDERSTOOD IN A VERY BROAD SENSE FROM CITIZENS SECURITY, AGRO-FOOD SECURITY, AIR-TRAFFIC SECURITY, ETC.	PUBLIC ADMINISTRATION, SECURITY & DEFENCE	SERVICES	AERONAUTICS & SPACE SAFETY & SECURITY
AGRI-FOOD: A TRANSVERSAL SECTOR WITH LINKS TO BOTH HIGH-TECH (I.E. BIOTECHNOLOGY) AND LOW-TECH INDUSTRIES (I.E. TOURISM).	AGRICULTURE, FORESTRY & FISHING	FOOD, BEVERAGE & TOBACCO PRODUCTS	
CULTURAL HERITAGE AND TECHNOLOGIES FOR CULTURE	CREATIVE, CULTURAL ARTS & ENTERTAINMENT CREATIVE, ARTS & ENTERTAINMENT ACTIVITIES	INFORMATION & COMMUNICATION TECHNOLOGIES (ICT)	CULTURAL & CREATIVE INDUSTRIES

The Province of Rome is the second largest concentration of population after Milan and, according to the last census, is home to about 7% of the Italian population and 74% of the

population of the Lazio region. It is a highly complex and heterogeneous urban region due to its morphological, functional and settlement characteristics.

Pending the entry into force of *Roma Città Metropolitana*, emerging interrelations between new productive patterns and urban growth account for general restructuring of the regional systems shaping new dependencies and/or autonomization paths from the traditional catchment areas, notably the Capital City and several major production clusters.

The four top ranking traded Regional aggregates of economic activities (*'traded cluster'* according to Porter), belong to so-called 'advanced services' (Table 3). This is consistent with the employment distribution pattern of an advanced, tertiary-led regional economy. In particular, 'Hospitality and Tourism' accounts for a flourishing tourism industry in the Capital City. With respect to manufacturing clusters, 'Biopharmaceuticals' and 'Video and Music' are among the most peculiar economic specializations of the area, the former being led by the presence of big pharmaceutical companies in the province and the latter related to the presence of the most important and productive movie industry nationwide.

Table 3. Roma Provincial Area. Top ranking economic activities

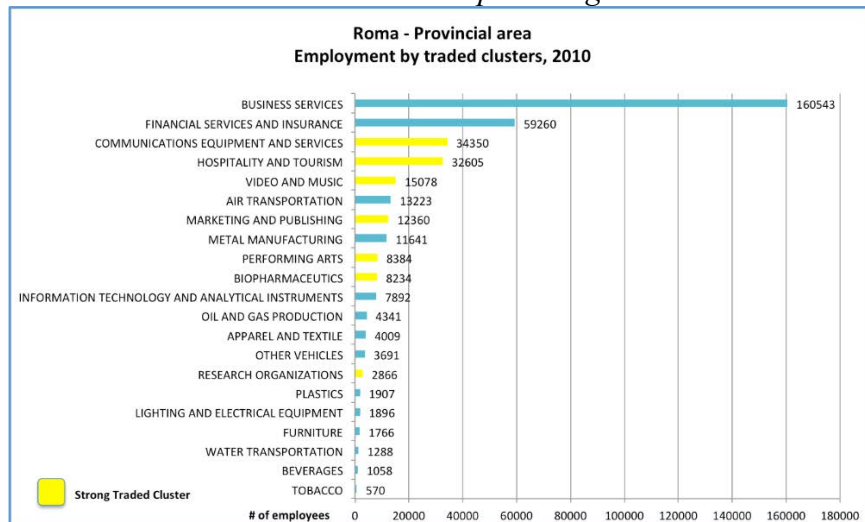

The other Provinces of Lazio (Viterbo-Rieti and Latina-Frosinone) host some of the leading manufacturing clusters in Italy (such as ceramic and paper 'districts'). They also reveal an important presence of biopharmaceuticals (or related) clusters, which are likely to be strongly intertwined with the one identified in the Province of Rome, thus giving further evidence of the pivotal role played by this sector in the area.

5. CONCLUSIONS

Rome and its outer ring keep dominating the regional economy, acting as catalysts for people, enterprises, advanced services and knowledge. This evidence still feeds the assumption that any decrease in production - and average household welfare - can be offset by development activities (among which traditional construction industry) spreading from the center to the outer territories.

On the backdrop, we have to rethink the relationships of interdependence and exchange between different local systems of Lazio (in full autonomy from Rome) and within an increasingly globalized market.

Ultimately, three major trends are likely to affect the forthcoming socio-economic transformations and settlement patterns: (i) Verticalism; (ii) Streamlining; (iii) Atomization.

(i) Ever-changing dynamics within the entrepreneurial milieu between multinational corporations, local businesses and the socio-institutional environment in terms of supply of goods and services requiring intermediate contractors, and/or large enterprises as shareholders of small companies with minority shares. Their overall strategies are differentiating, even within a same sector area, depending on their relationships to local and global contexts.

(ii) Inefficiency in delivering goods and services to the final destination: so-called ‘Last mile’ issue in linking suppliers and customers lays in poor maintenance of the road system and in lack of appropriate investments in infrastructures for interregional connectivity. These criticalities also compel to rethink interdependencies and exchanges within the Region, sometimes in full autonomy from Rome, and under the perspectives of increasingly globalized markets.

(iii) Industry 4.0 is far less polluting, but is all-pervasive. Still, it needs to put down roots in specific living environments with previous settings and rules. Innovation districts worldwide strive to promote models of facilitators - startups, business incubators, consortia - likely to envisage ‘territory’ as an opportunity rather than a cost.

What kind of ‘territorial governance’ can be performed?

When it comes to ‘territory’ and ‘settlement patterns’, we may refer to Local Systems (*Sistemi locali del lavoro*), generated by commuting trips, which have proven a good proxy for daily urban systems, where most activities and interactions among people and economic actors occur independently of any regulations from above. Notwithstanding, they are increasingly regarded as real arrangements which shape daily life.

Or else we may refer to the fundamentals of spatial planning that lie within regional plans, such as the General Plan of the Province of Rome which has come into force in 2008. As a matter of fact, the General Plan aims at reassessing and overhauling the productive structure avoiding and rectifying unfitting settings.

Metropolitan Strategic Parks (PSMs) and Metropolitan Productive Parks (PPMs) are designed to provide good accessibility conditions and the share of facilities among different firms.

In adjunction to existing planning strategies, new regulations are to be established without delay (the Regional Law ‘Testo Unico in materia Urbanistica ed Edilizia’ is under consideration), even more so that new global economies are increasingly run by external factors and exogenous interests, requiring resources and expertise devoted to shaping variable geometries in economic and territorial policies.

Whatever the case, ‘space’ matters.

On the sustainability grounds, the metropolitan area falls short of expectations in several areas: green waste, smart mobility, and especially emerging productive sectors such as the green economy. From the outside, the Roman agglomeration is still perceived as a huge market for goods and services rather than as an employment catchment area or a place to invest money.

In the rest of the Metropolitan area and in the Lazio region, the huge industrial estates dating back to the 50s and 60s are poorly sustainable and far from any idea of “urbanity”: the people working here live elsewhere.

The forthcoming policy Agenda of the Lazio Region should take into due account all these crucial issues, in order to perform a sustainable and resilient approach to ‘territorial innovation’ complying to the strategic objectives of Europe 2020. It is therefore imperative to address the regeneration of these huge hinterlands.

6. REFERENCES

- Aa.Vv. (1967). *Progetto 80*, “Urbanistica”, n. 49, numero monografico.
- Aldrich H. E. and Fiol C. M. (1994). Fools rush in? The institutional context of industry creation, *Academy of Management Review* 19(4), 645–670
- Battaglini, E., Davico, L., De Santis, G., Palazzo, A.L. (2014). *Non tutte le strade portano a Roma*, I Rapporto della Fondazione G. Rota sull’Innovazione territoriale sostenibile del Lazio, Torino, Guerini.
- Camera di Commercio di Roma (2013). *Il sistema produttivo culturale nella provincia di Roma: ruolo e capacità di attivazione economica* http://www.rm.camcom.it/archivio59_comunicati-stampa_0_594_388_1.htm.
- Caracciolo, A. (Ed). (1991). *Il Lazio*, della serie *Storia d’Italia, le Regioni dall’unità ad oggi*, Torino, Einaudi.
- CER-Unindustria (2012). *Un progetto per lo sviluppo del Lazio. La discontinuità per tornare a crescere* <http://www.un-industria.it/Prj/Hom.asp?gsPagTyp=21&flnCod=26838>
- Cerrito, E. (2010). *La politica dei poli di sviluppo nel Mezzogiorno. Elementi per una prospettiva storica*, in Banca d’Italia – Eurosystema, “Quaderni di Storia Economica (Economic History Working Papers)”, n. 3.
- Clementi, A., Dematteis, G., Palermo, P.C. (Eds). (1996). *Le forme del territorio italiano*, Roma- Bari, Laterza.
- CNA Roma e Lazio - Centro Europa Ricerche (2013). *Indagine congiunturale sulle piccole imprese della Regione Lazio*, <http://www.cnapi.org/News/Presto-un-tavolo-tra-imprese-e-Regione-su-credito-export-reti-e-infrastrutture>
- Commissione Europea (2010). *Europa 2020. Una strategia per una crescita intelligente, sostenibile e inclusiva*, Bruxelles.
- Crescenzi R., Iammarino S., Rodríguez-Pose A. (2016). *Multinazionali, imprese locali e Sviluppo economico nella Regione Lazio*, London School of Economics.
- De Martino, U. (2008). *Il governo delle aree metropolitane*, Roma, Officina.
- De Muro, P., Monni, S., Tridico, P. (2011). “Knowledge-based economy and social exclusion: shadow and light in the Roman socioeconomic model”, in *International Journal of Urban and Regional Research* Vol. 35 issue 6, pp. 1212-1238.
- Filas (2010). *Settimo Quadro Regionale di Valutazione dell’Innovazione. Innovation Scoreboard Regione Lazio*.
- Filas (2012). *Ottavo Quadro Regionale di Valutazione dell’Innovazione. Innovation Scoreboard Regione Lazio*.
- Foray, D., David, P.A., Hall, B. (2010). *Smart Specialization: the Concept*, http://ec.europa.eu/research/era/publication_en.cfm
- Industrie 4.0 Working Group (2013). *Recommendations for implementing the strategic initiative Industrie 4.0*.
- Ispra (2016). *Consumo di suolo, dinamiche territoriali e servizi ecosistemici*, Roma. <http://www.isprambiente.gov.it/en>.
- Istituto Nazionale di Urbanistica (2011). *Rapporto dal Territorio 2010*, Roma, Inu Edizioni.
- Lelo, K. (2017). *Dynamics in the Creative Sector between Rome and the Sea*. “International Studies. Interdisciplinary Political and Cultural Journal”, Issue No. 19.3.
- Maggioni, M. A. (2002). *Clustering dynamics and the location of high-tech-firms*. Springer Science and Business Media.
- Martinotti, G. (1993). *Metropoli. La nuova morfologia sociale della città*, Bologna, Il Mulino.
- Ministero per le Infrastrutture, Dicoter (2007). *Reti e territori al futuro. Materiali per una visione*, Roma, Mimeo.

- Musci, L. (1996). *Il Lazio contemporaneo: regione definita, regione indefinibile*, in Regione Lazio, *Atlante storico-politico del Lazio*, Bari, Laterza, pp. 125-166.
- Paladini, E. (2007). *Distretti industriali e sistemi produttivi locali nel Lazio*, “QUER - Quaderni di Economia Regionale”, n. 5, Collana del Servizio Studi di Sviluppo Lazio, Anno I.
- Regione Lazio (2014). *Smart Specialisation Strategy*, <http://www.regione.lazio.it>
- Regione Lazio, Roma Tre, Censis (2010). *Atlante e scenari del Lazio metropolitano*, Roma, Alinea, pp. 13-21.
- Regione Lazio, Sviluppo Lazio (2013). *Rapporto 2012 sull'economia del Lazio*, http://www.sviluppo.lazio.it/files/6/sviluppo_lazio_rapporto_2012_pdf_sito_02.pdf.
- Resmini, L., Torre, A. (2011). *Competitività territoriale: determinanti e politiche*, Milano, Franco Angeli.
- Sforzi, F. (1987). “L'identificazione spaziale”. In: Becattini, G. (Ed). *Mercato e forze locali*. Bologna, Il Mulino.
- Sorenson O. and Audia P. G. (2000). The social structure of entrepreneurial activity: Geographic concentration of footwear production in the United States, 1940–1989, *American Journal of Sociology* 106, 424–462.
- Unioncamere Lazio, Censis (2010). *Impresa, territorio e direttrici di sviluppo nel Sistema Lazio. Una mappa ragionata del capitale produttivo regionale*, <http://www.comune.roma.it/PCR/resources/cms/documents/UCLraplazio.pdf>.
- Unioncamere Lazio, Censis (2010). *Scenari evolutivi e strategie operative per i poli produttivi del Lazio*.
- Vitali G. (2016). *Una politica di filiera per le relazioni tra le imprese nei distretti industriali*. In: Cappellin R. (ed). *Investimenti, innovazione e nuove strategie d'impresa. Quale ruolo per la nuova politica industriale e regionale?* Milano, Egea, pp. 89-99.
- Wenting, R. and Frenken, K. (2011). Firm entry and institutional lock-in: an organizational ecology analysis of the global fashion design industry. *Industrial and Corporate Change*, 20(4), 1031-1048.

TOWARDS AN ASSESSMENT METHODOLOGY FOR SMART SPECIALISATION STRATEGIES: SPATIAL ECOSYSTEM FOR INNOVATORS' HOTSPOTS

C. Trillo

School of the Built Environment, University of Salford, Salford, M5 4WT, UK

Email: c.trillo2@salford.ac.uk

Abstract: The place-based development, as advocated by the European Commission through the Smart Specialisation Strategy (S3), is more than just an economic development strategy since its benefits allow for the achievement of more sustainable local economies. This paper presents an intermediate step in the achievement of the goals of an EU H2020 granted project, namely MAPS led, which stems from the assumption that spatially-led strategies can better meet the intentions of a place-based approach. After having developed a method to visualize socio-economic data at a level of granularity consistent with a place-based approach, the project is now entering its second fundamental stage which is about developing a novel assessment method to approach Smart Specialisations. This is undertaken by incorporating social innovation and civic engagement in the process of policy making and implementation. In detail, the paper focuses on the spatial factors and related triggers, which allow a full exploitation of the S3 in order to design a framework for a comprehensive assessment of the S3 potential. In so doing, it draws from case studies in the US to corroborate findings and conclusions with a robust empirical dataset.

Keywords: MAPS-LED, Place-Based And Sustainable Development, Smart Specialisation Strategies

1. INNOVATION – DRIVEN LOCAL DEVELOPMENT

Whilst a widespread interest in innovation-driven economic development is emerging (Madelin, 2016), yet still current assessment approaches and related methods/instruments/ tools show deficiencies in catching up with the dynamic nature of innovation. Furthermore, the persistent dichotomy between quantitative versus qualitative approaches hinders the capability to capture the holistic and complex nature of social capital-embedded phenomena. Although it is possible to narrow down at the urban level regional datasets relating to cluster analysis as in the traditional cluster analysis approach (Porter, 1990; www.clustermapping.us), an exclusively quantitative based approach is still not suitable to detect emerging clusters, due to their dynamic nature. These limitations challenge the adoption of traditional methods of assessment whilst tackling the evaluation of the so-called Smart Specialisation Strategies (S3) endorsed by the European Commission and based on the concepts of entrepreneurial discovery and risk taking (Foray, 2015; McCann & Ortega-Argilés, 2015). This paper draws on, and puts forward, a EU H2020 granted project, namely MAPS led, which stems from the assumption that spatially-led strategies can better meet the intentions of a place-based approach. After having developed a method to visualize socio-economic data at a level of granularity consistent with a place-based approach, the project is now entering in its second fundamental stage which is about developing a novel assessment method to approach Smart Specialisations. This is undertaken by incorporating social innovation and civic engagement in the process of policy making and implementation and by operationalising them in the form of assessment grid. In detail, the paper focuses on the governance mechanisms which allow a full exploitation of the S3 in order to design a framework for a comprehensive assessment of the S3 potential. In so doing, it draws on case studies in the US and in Europe. In detail, preliminary studies, aimed

at exploring the issue further, were conducted by interviewing selected key-stakeholders on issues and opportunities for the S3 implementation in the Manchester, UK, area. They showed that: (1) in the Manchester area, the S3 strategy was possibly underestimating the potential of some emerging clusters, such as the digital technology applied to the media, with the huge potential of supporting local development; (2) where innovation was happening, the alignment between innovation-driven economic development and social innovation was not deliberately regulated; (3) the stakeholders' engagement process in determining what S3 should be pursued could have benefitted from a higher clarity in the organisation and implementation of the process; (4) the S3 rationale was deeply interconnected with the devolution agenda (i.e., the formation of the Northern Power House political alliance and the constitution of the Greater Manchester Authority as an elected body). This preliminary investigation was conducted with the aim of achieving a better understanding of the gaps to be filled in the European context. Although the S3 official documents seemed to depict a clear and univocal approach to the S3, in reality a shared approach on the concrete application of S3 was far from being fully developed in all its aspects. In particular, room for discussion existed on the role played by innovation in supporting (or not) equitable development, paving the way to broadening the research questions with regard to the connection between innovation-driven versus *social* innovation-driven local economic development. The Habitat III Agenda has better clarified the nexus between the economic and social agendas, particularly within cities. The Sustainable Development Goals, as defined in the Quito UN Summit, can be considered key drivers in framing the concept of "sustainable innovation", reflecting the main aim that socially-driven innovation should pursue (<http://www.un.org/sustainabledevelopment/sustainable-development-goals/>).

The way towards the assessment of how far innovation-driven development is also sustainable (hence, incorporates the *social* innovation component) is by using the *space* as the common ground to appraise the alignment of all the factors which make sustainable innovation possible.

This paper seeks to address the following questions: (1) What problems should be addressed by delivering a better assessment methodology for S3 in spatial terms? (2) What are the possible spatial enablers of place-based and locally-embedded development? A novel assessment methodology will be suggested, seeking to address the following issues: (1) How to select indicators for assessing the potential of S3, consistent with the S3 rationale (granularity, timely availability, place-based)? (2) How to create the *spatial ecosystem* supportive of an efficient S3 implementation? (3) What best practice of "spatial enablers" holding a transferability potential can be identified, by drawing on evidence from empirical research conducted in the Boston area?

It is anticipated that this paper will conclude that: (1) The set of indicators usually adopted to understand, appraise and monitor innovation process are not fully consistent with the S3 rationale. The paper will suggest a strategy to address this gap, namely: (2) The spatial factors that made innovation possible in the Boston area that have been identified through a survey and a set of interviews. The paper suggests a list of the most important *innovation- supportive spatial factors* to be prioritized by innovation focused policies, both public and private; (3) Innovation is particularly boosted in specific dense places (*hotspots*) which act as enablers of innovative mechanisms suitable to be spread around and be interconnected with the innovation ecosystem locally and internationally. The paper suggests how such an "innovation supportive" ecosystem should be spatially organised and what different types of spatial enablers can be activated in a target area; (4) Innovation is spurred by *triggers* or *activators* which can be individuals (*champions*), organisations, task forces, thus starting the process.

2. TOWARDS A NOVEL METHODOLOGY FOR ASSESSING EMERGING INNOVATION: MAPPING SOCIAL INNOVATION

A constructivist approach has been considered the most appropriate to investigate the research problem. A case study strategy has been adopted in order to achieve an in-depth understanding of innovation-driven economic development in the selected area with the aim of developing transferable instruments and recommendations. The case study production and analysis was conducted in the Boston area over a 12 months' period through a mix of quantitative and qualitative methods applied to a selection of sub-case studies (the innovation *hotspots*, as explained in more detail later). The sub-case studies were initially selected through desk analysis and interviews with key experts from the Boston area; then the initial selection was refined following the first round of interviews. The selection of the sub-cases started in March 2016 through a set of interviews aimed at narrowing the focus on the investigation and understanding the most appropriate areas to target. The desk analysis included academic papers and technical reports on innovation districts, planning documents and reports on innovation districts in the Boston area and a general planning framework for the Boston area. The desk analysis was complemented through participation in conferences and public discussions on Boston metropolitan area urban and economic issues. After one year, the findings incorporated in this report were discussed with experts on public policies and economic development based in the Boston area in order to better focus on the possible gaps still existing in the suggested approach. The feedback received led to the following improvements: (1) the assessment methodology was re-cast within the developmental evaluation conceptual framework for public policies, and (2) notwithstanding the scope of the methodology is to bridge the gap between micro and macroscale, it was clarified that it is essential to focus on a given scale; also there is a necessity to understand the most appropriate stakeholders to be involved in the delivery of the policies.

The hotspots have been studied by conceptualising the urban environment following the rationale of *urban patterns as cognitive infrastructure* (Trillo, 2016), hence, by rejecting a boundary-led criterion and by focusing on “hotspots” of innovative development. Key-hotspots have been identified: The Cambridge Innovation Center (CIC) in Kendall Square, Cambridge; The Boston Innovation Center and the Boston Impact Hub in Milk St, downtown Boston; The District Hall in the Seaport District; The Roxbury Innovation Center (RIC) in the Roxbury area, Dudley Square; The Boston Masschallenge in the Seaport District; The PULSE in the Longwood area; The GreentownLab in Sommerville, and the Venture Café. In some cases the hotspots allowed for the identifying of emerging clusters (Kendall: BioFarma, Longwood: E-Health; Roxbury: low-tech); in some cases, they were related to specific regeneration spatial strategies (District Hall: Seaport District regeneration; Roxbury Innovation Center: Dudley Square regeneration).

The two main research tools used to investigate the 8 hotspots were: Questionnaires – to provide insights on case studies from a mainly quantitative perspective; Interviews - to provide in-depth and personalised insights on case studies from a mainly qualitative perspective. The questionnaire aimed at investigating: (1) What are the spatial factors that make the area surrounding the hotspot attractive for the companies? (2) What are the major impacts that the hotspot produces on the surrounding area? (3) What are the spatial linkages of the hotspots in terms of housing, transport and services? The questionnaire was tested by administering it with a start-up based in the Cambridge Innovation Center. Through the testing it emerged that some generic terms (i.e. “amenity”) could have misled the interviewees, thus, it was decided to specify, for each location, the site-specific factors which could be related to a certain category.

For example, instead of asking interviewees to rate the importance of landscape amenities in the Kendall Square area or in the Seaport District, the questions were formulated to provide a rating on the importance of, respectively, the Charles River and the sea view. This led to creating as many questionnaires as the hotspots that were selected.

The questionnaires were delivered through a Survey Monkey tool by the MAPS LED team members. Initially, a paper version of the questionnaire was prepared. When the questionnaire was tested, it emerged that the best way to deliver it across the targeted people (i.e., innovators reluctant to use traditional tools and thus more likely to fill in a web based questionnaire) was a Survey Monkey tool. Hence, the 8 questionnaires were each associated to a web link. Although the delivery of the survey was web-based, personal interaction with each company was essential in ensuring the response rate necessary to get a significant snapshot of the interviewee opinions. In 4 cases (CIC, Boston Innovation Hub and Boston Innovation Center, RIC and District Hall) this was achieved by attending several social events and/or working in the different hotspots (6 sessions at the Venture Café Thursdays at CIC, 2 sessions at the Roxbury Night Café, 1 social event at the Innovation Hub Boston; 4 working days spent at the District Hall), approaching individually each company/ individual working in each of the places and explaining the reasons for the survey. In some few cases, the questionnaire was filled in jointly. In the majority of the cases, people approached during social events or while working preferred to defer the survey. This reduced the response rate but allowed compliance with the ethical principle of fully voluntary participation in the survey and, most importantly, it meant that the researchers were not considered to be intrusive by the management of the different places, thus allowing a more extensive delivery of the survey.

For each of the hotspots the survey was enhanced by a qualitative data collection based on semi-structured interviews with key-informants for each of the selected hotspots. All the hotspots were investigated by talking to at least 2 different people in different roles in the organisation. All the semi-structured interviews were preceded by preliminary interviews aimed at correctly framing the case. Extensive qualitative fieldwork complemented the data gathering based on a visual survey of the hotspots and surrounding areas and on direct observation of the behaviour of the users of the innovation hotspots. This was conducted by spending several hours observing the hotspots over a 10 months' period (June 2016 - March 2017) at different times of the day and of the year (3 rounds of observation: June 2016, August 2016, March 2017), taking pictures and talking to the people working in the hotspots.

The investigation of the 8 main hotspots was complemented with a direct study of 12 further places whose importance had emerged through the interviews in the first round. These cases were investigated by administering semi-structured interviews with key informants and by direct observation (no survey were administered). The list of the 12 further places were: Fairmount Innovation Hub, Dorchester; Mass Innovation Labs, Kendall Square; Smarter in the City, Roxbury; JPND A Brewery, Jamaica Plain; Commonwealth Kitchen, 196 Quincy Street; WeWork South Station, Boston; WorkBar Leather District, Boston; Intrepid Labs, Cambridge MA; Trumotion, Boston; Breather, Downtown Boston; Idea, Northeastern Innovation Hub, Boston; Artisans' Asylum, Somerville. Hence, a total of 20 places provided the main body of empirical evidence for the findings used in the construction of the grid of assessment. Overall, 40+ informal interviews have been administered with experts and key informants, delivered between April and June 2016 in order to narrow the focus in the data gathering process; in addition to 40+ semi structured formal interviews with experts from different stakeholders' groups (public, private, NGOs), and 100+ questionnaires were received.

All the empirical evidence was used in order to produce a novel assessment methodology suitable in supporting the detection of early stage innovation areas and to appraise their potential in terms of innovation. Traditional assessment methods are seriously challenged when applied to dynamic and highly interconnected systems such as an innovation ecosystem. While innovation is a static concept, innovators do move, do concentrate and do network, creating multiple spatial patterns of innovation which reflect the flows of innovation across different areas. For this reason, the spatial pattern of innovation has been re-conceptualized as a network of spatial hotspots connected by flows of knowledge, rather than as identifiable areas. However, innovation still happens within a given space which is related to the geographical area in which the main stakeholders in charge of making innovation happen, operate. Furthermore, it is the geographical area that allows for the identifying of decision makers in charge of operating in each space (governance); thus, while the space of innovators should be conceptualised as a dotted network for the purpose of the data collection, the space of the decision makers still rests upon a traditional definition of institutional boundary. For this reason, the regional scale remains the most appropriate to investigate innovators' spatial dynamics and, therefore, the hotspots were identified within the Boston metropolitan area and not at a local scale. In particular, they were selected within the following three cities: Boston, Cambridge and Somerville.

This evaluation framework is: (1) based on a socio-constructivist approach aimed at drawing insights from the knowledge embedded in the community of innovators, and (2) shaped beyond the administrative/institutional boundaries by selecting urban "hotspots" of innovators and expanding around them multiple boundaries incorporating key infrastructures and services on different scales.

The adoption of traditional assessment methods in innovation areas is challenged by a variety of factors. The boundaries of innovative clusters are blurred and extremely dynamic. Findings from the survey corroborated this perception, by showing the international projection of many of the companies in the hotspots. Rather than creating a list of indicators to be mapped within a given boundary, the suggested methodology is based on the idea of "detecting" an innovative hotspot and, from there, mapping around the significant elements creating the sustainable innovation ecosystem for the (early stage) innovative hotspot to grow. The rationale for assessing whether and how far the ecosystem around a given hotspot is supportive of an innovation-driven economic development, will be to appraise the alignment of all factors by visualizing, at the appropriate scale, the key factors supporting the growth of that hotspot; hence, the spatial configuration of innovators and hotspots remains crucial.

The key spatial indicator for mapping social innovation is the number of spaces where innovation happens within a defined building because of the presence of either an incubator or an accelerator (regardless of whether public or private), allowing a critical mass of start-ups to grow. Where these spaces are significantly present, the following dynamic is activated: (1) they act as an anchor for bigger companies in search of talents and or new ideas; (2) they are mutually supportive and reinforcing; (3) they attract venture capitalists further boosting the economic growth.

Patents are still a key indicator for innovation but they are not suitable to detect people-driven innovation at an early stage, rather to confirm that successful innovation-driven growth is happening. It is, therefore, suggested that S3 should be activated where the local entrepreneurial social capital shows a high potential of growth and that the presence of a variety of innovators' hotspots can be the way of assessing it.

The theoretical assumptions behind this model are: (1) Smart Specialisation rests on an organic conceptual paradigm, according to which innovation happens when the overall “ecosystem” is innovation-supportive; (2) Smart Specialisation must encompass the concept of social innovation as a major driver for an equitable growth and development; (3) Smart Specialisations should be spatially identifiable at an appropriate level of granularity, and (4) Smart Specialisations build on the concept of cross-fertilization across different sectors rather than on an individual sector.

The first three concepts lead to framing the ideal setting for Smart Specialisation within a sustainable urban environment and, in fact, some significant areas of overlapping can be identified between the S3 and the Sustainable Development Goals launched last year by the UN. The first and fourth concepts recall the idea of mixed use development which is still a basic pillar of sustainable urban development. It is, hereby, theorized that Smart Specialisation, intended as embedded development strategies, require as fertilizer innovative ecosystems which in spatial terms coincide with, but are not fully accomplished by, the prerequisite of sustainable urban regeneration as redefined by the UN through the Sustainable Development Goals.

The following diagram shows how to conceptualise both the assessment rationale for sustainable innovation driven S3, which should be embedded in S3, and the assessment rationale for addressing the prioritisation of public and private policies aimed at achieving socially-driven innovation.

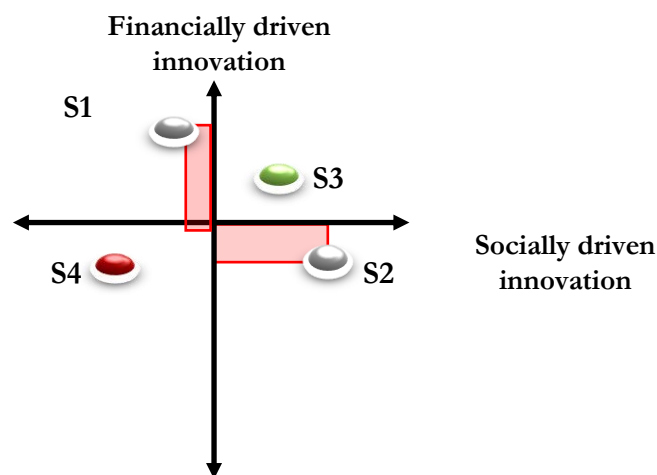

Figure 1: Rationale for the assessment grid of S3

In Figure 1, S3 are located in the top-right quadrant, meaning that they are both sustainable financially and socially. S1 are successful strategies based on non-necessary socially-driven innovation, for example, based on an externally sourced highly skilled workforce working for external companies bringing financial surplus to a certain area, but undermining the social structure and displacing rather than building on the local social capital. S2 are successful strategies based on exclusively socially driven innovation, not capable of sustaining themselves financially in the long term; they are in constant need of being subsidized and are, therefore, fragile and not reliable in times of financial crisis. A further component could be added to the conceptual diagram which is the time, since strategies can significantly change throughout their lifetime, but reasons of clarity this aspect will not be considered.

The methodology hereby suggests applying a framework allowing an understanding of to which quadrant a given strategy belongs and what tools/ instruments can be adopted in order to move towards the top-right quadrant.

3. CONCLUSIONS: WHAT SPATIAL FACTORS TO ASSESS AND HOW?

The previous section showed how the metropolitan area of Boston was investigated by focusing on specific innovation “hotspots” within the region while considering the scale of broad issues which emerged from the answers of the respondents (typically, local/regional/international), i.e., approaching the innovation “hotspots” as dots in a multi-scalar network embedding local-international linkages, both physical and non-physical. By looking at the performance of those networks from the social innovation perspective, evidence from Boston led to the formulation of the following:

- (1) The scale of social innovation: social innovation is activated by networking at multiple scales. The networking works both horizontally and vertically, creating local-local and local-international linkages that activate the circulation of knowledge and generate spillovers far beyond the border of the Boston metropolitan area. In particular, such spillovers promote equity by binding lagging behind either neighbourhoods in the same city or even cities outside the Boston metropolitan area, thus allowing a consistent level of highly specialised expertise across a variety of different social contexts. A good example of this is the Venture Café’ network, linking together two Innovation Centers in competitive neighbourhood (the Cambridge and the Downtown Boston ones) with an Innovation Center triggering the economic revitalisation of a formerly deprived and blighted area (the Roxbury one). It also networks with other US cities (e.g. St. Louis) and even European cities (Rotterdam). However, evidence of a correlation between this mechanism and the parallel process of regenerating the area is still far from being proved.
- (2) The location of the innovators: social innovators are spread across different categories of stakeholders. Sophisticated governance allows for a blended public private approach, encompassing civic organisations, second tier NGOs, collaborating through structured frameworks thus allowing space for risk taking even in those sectors which are usually risk-adverse. A good example of this is represented by UrbanMechanics, a task force operating in close conjunction with the City of Boston Mayor allowing for experimentation and the testing of initiatives with the aim of upscaling only those that demonstrate that they can be successful.
- (3) The spatial ecosystem for innovation hotspots: innovation hotspots work better in walkable environments and in socially and physically dense neighbourhoods. Physical and spatial planning in all the places investigated supported the densification of the area, by increasing the public transport and encouraging mixed-use. Evidence has shown that these kinds of urban ecosystems tend to be more attractive for innovators. This happens because social innovators are usually environmentally conscious and tend to prefer more sustainable urban patterns but also because social innovators tend to prefer socially interesting environments, hence, dense and high-quality urban settings.

Drawing from the findings above, table 1 shows the assessment grid of factors.

Table 1: Assessment grid for innovation – driven development

SPATIAL FACTOR	TRIGGER	SPATIAL TOOL	ECOSYSTEM
Dense and walkable urban environment	Public local authorities	Mixed use Public transit	Proactive local public authorities
Spatially identifiable hotspots	Private companies HE institutions Public local, regional and national authorities	Incubators Accelerators (both public and private)	Anchor companies Anchor institutions Champion(s)
Local2local and local2global networks	Private companies HE institutions Public local, regional and national authorities	Spatial proximity of the local2local networks	Local and global incubators Local and global accelerators
Spatially identifiable civic innovation centres and socially driven incubators	Public local authorities NGOs	Regeneration initiatives Civic centres Social incubators	Active local authorities Active communities
Spatially identifiable anchor HE institutions	HE institutions	HE anchors HE accelerators and incubators	Starts-ups generated by the HE institutions

The grid can be both used to assess the state of the ecosystem of a given region, understanding whether it can be considered mature enough to support a S3 environment, and for filling gaps which can be identified by appraising the presence of all the given factors in an area. It should be observed that, in all the cases, the whole ecosystem worked with the physical presence of all the elements in place, in other words, physical proximity remains the precondition for an ecosystem to work and no factor can be replaced by externally sourced assets.

Possibilities for further research include expanding on the land value and cluster dynamics' nexus. It has been clarified how the current cluster analysis does not reflect the dynamic nature of the clusters, thus failing in detecting emerging areas for innovative clusters. However, the dynamic nature of cluster development is directly related to the value of land (and rents). Further studies could investigate the correlation between changes in the clusters' patterns and property market dynamics.

4. REFERENCES

- Foray, D. (2015). *Smart specialization: Opportunities and challenges for regional innovation policy*. London: Routledge.
- Madelin R., Ringrose D. (2016). Opportunity Now: Europe's Mission to Innovate, European Commission.
- McCann, P., Ortega-Argilés R. (2015). "Smart Specialization, Regional Growth and Applications to European Union Cohesion Policy", in *Regional Studies*, vol. 49, no. 8, pp. 1291-1302.
- MAPS LED, *Multidisciplinary Approach to Plan Smart Specialisation Strategies for Local Economic Development* (2015), Project ID: 645651, http://cordis.europa.eu/project/rcn/194342_it.html.
- Porter, M. E. (2000), "Location, Competition and Economic Development: Local Clusters in a Global Economy", in *Economic Development Quarterly*, vol. 14, no. 1, pp.15-20.
- Trillo C. (2016). Smart Specialisation Strategies as Drivers for (Smart) Sustainable Urban Development, *Sustainable Urbanization*, Dr.Ing. Mustafa Ergen (Ed.), InTech, DOI: 10.5772/64598. Available from: <https://www.intechopen.com/books/sustainable-urbanization/smart-specialisation-strategies-as-drivers-for-smart-sustainable-urban-development>.

Generously supported by:



Conference Co-Chairs
Professor Hisham Elkadi
Professor Les Ruddock

Organising Committee
Dr Chaminda Pathirage
Professor Carl Abbott
Hanneke van Dijk
Charlotte Houghton

The University of Salford
Salford, M5 4WT
t: +44 (0)161 295 5000
www.salford.ac.uk

ISBN 978-1-912337-04-0



9 781912 337040 >