

University of
Salford
MANCHESTER

ARCHAEOLOGY

**Gorton Monastery:
An Archaeological
Evaluation Report**

Final

Client: The Monastery
of St Francis and
Gorton Trust

Technical Report:
Adam Thompson

Report No: 21/2015

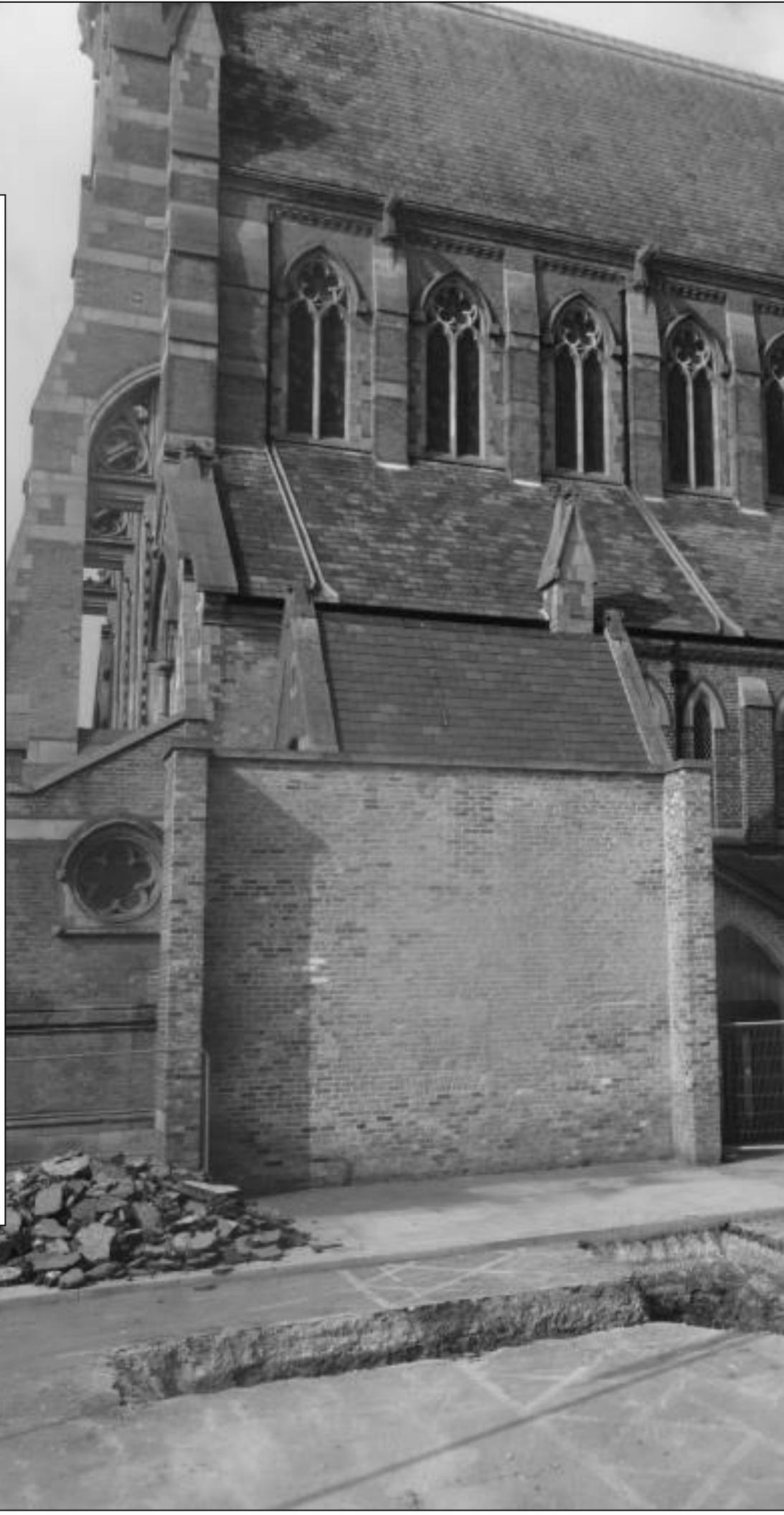

Site Location: The Church and Friary of St Francis located on Gorton Lane in Gorton. Gorton is an inner city suburb of Manchester, located approximately three miles to the south east of the city centre.

NGR: SJ 87662 96872

Internal Ref: (CfAA/021/2015)

Planning Ref: N/A

Prepared for: The Monastery of St Francis and Gorton Trust

Doc Title: Gorton Monastery: An Archaeological Evaluation.

Doc Type: Technical Report

Version: Version 2.0

Author: Mr Adam J Thompson BA Hons, MA,

Position: Director

Date: September 2015

Approved By: Dr Michael Nevell

Position: Head of Archaeology

Date: September 2015

Copyright: Copyright for this document remains with the Centre for Applied Archaeology, University of Salford.

Contact: Centre for Applied Archaeology, University of Salford, Joule House, 1 Acton Square, Crescent, Salford, Greater Manchester, M5 4DW

Telephone: 0161 295 3818

Email: a.thompson@salford.ac.uk

Disclaimer:

This document has been prepared by the Salford Archaeology (Centre for Applied Archaeology, University of Salford) for the titled project or named part thereof and should not be used or relied upon for any other project without an independent check being undertaken to assess its suitability and the prior written consent and authority obtained from Salford Archaeology. The University of Salford accepts no responsibility or liability for the consequences of this document being used for a purpose other than those for which it was commissioned. Other persons/parties using or relying on this document for other such purposes agrees, and will by such use or reliance be taken to confirm their agreement to indemnify the University of Salford for all loss or damage resulting therefrom. The University of Salford accepts no liability or responsibility for this document to any other party/persons than by whom it was commissioned.

Contents

1. Summary	4
2. Introduction	5
3. Location and Topography	6
4. Archaeological & Historical Background	8
5. Methodology Statement	12
6. Evaluation Results	13
7. Finds Assessment	26
8. Archaeological Discussion	27
9. Sources	28
Appendix: List of Contexts	29

1. Summary

Salford Archaeology at the Centre for Applied Archaeology, University of Salford undertook an archaeological evaluation in advance of development works on an area of car parking to the immediate south of the Gorton Monastery building.

The Church and Friary of St Francis located on Gorton Lane in Gorton. Gorton is an inner city suburb of Manchester, located approximately three miles to the south east of the city centre and is centred upon SJ 87662 96872.

Three evaluation trenches were placed across the development area to determine the extent, nature and survival of potential archaeological remains relating to the southern and eastern wings of the friary.

The three trenches located remains associated with the southern cloister wing of the monastery. These showed that the northern and southern exterior walls were substantially built stone foundations (T3). There were small stone internal walls, but no internal floor levels survived. It looked as the area had been levelled for the construction of the walls and then rubble built up around them.

Trench 1 located the wall remains of the eastern cloister range. These had foundations of brick, and were less massive than those of the southern range. Small internal brick cross walls were also located. Again no internal floor levels were found. Whether the difference in construction techniques represented a different phase is unclear as the junction of the two wings was not excavated.

The North West England Archaeological Research Framework notes that the proliferation of urban places of worship during the 19th century was a distinctive feature of the new industrial communities of the region. Many of these sites have been demolished or survive only in a partial state. Furthermore detailed recording is sporadic and certain types of site are under-recorded, or in the case of Gorton Monastery very rare (Brennand 2007, 147-8). The remains located in the current evaluation excavation demonstrate that remains of the southern and eastern cloister range survive on the site. They also show that the same care and attention to detail seen in the rest of the complex was lavished on the cloister range.

2. Introduction

- 2.1** Salford Archaeology at the Centre for Applied Archaeology, University of Salford undertook an archaeological evaluation in advance of development works on an area of car parking to the immediate south of the Gorton Monastery building.
- 2.2** This document has been prepared by Mr Adam Thompson, Director of Salford Archaeology on behalf of the client as a result of the evaluation works and has been checked and verified for issue by Dr Michael Nevell, Head of Archaeology at the University of Salford.
- 2.3** An archaeological Desk Based Assessment was conducted by Kathryn Sather & Associates in March 2014 and the subsequent archaeological brief issued by Mr Norman Redhead of the Greater Manchester Archaeological Advisory Service recommended the archaeological excavation of three trenches across the proposed development area.
- 2.4** The exact location of the designed trenches proved to be logistically challenging in order to maintain access to the monastery and as a result, following discussions with Mr Redhead and agreed by the client the trench design and final locations were altered.
- 2.5** A total of three trenches were excavated across the development area and located substantial stone foundations of the former east and southern wings of the Friary, which are dated to the 19th Century. No cellarage or floor surfaces were identified during the excavation and the area was sterile of artefactual material apart from the recovery of a 19th Century stoneware jar.
- 2.6** Common acronyms and terms utilised within the document

CBA	Council for British Archaeology
CIFA	Chartered Institute for Archaeologists
CfAA	Centre for Applied Archaeology, UoS
DBA	Desk Based Assessment
EH	English Heritage
EIA	Environmental Impact Assessment
FAME	Federation of Archaeological Managers and Employers
GMAAS	Greater Manchester Archaeological Advisory Service
HER	Historic Environment Record
LBC	Listed Building Consent
MCC	Manchester City Council
NPPF	National Planning Policy Framework
PPS5	Planning Policy Statement 5
RAO	Registered Archaeological Organisation (CIFA)
SCC	Salford City Council
UoS	University of Salford
WSI	Written Scheme of Investigation

3. Location and Topography

3.1 Location (Fig 1)

The Church and Friary of St Francis located on Gorton Lane in Gorton. Gorton is an inner city suburb of Manchester, located approximately three miles to the south east of the city centre and is centred upon SJ 87662 96872.

3.2 Topography and Geology

Greater Manchester is located in the central section of the Mersey basin. The geology of the area is divided into two zones. To the north is an area of bedrock that is predominantly Permo-Triassic Bunter Sandstones. This continues to the south and west until it meets the North Cheshire plain, where there is Mid Triassic sand and mudstone groups.

The landscape reaches a height of approximately 110 metres above sea level. This falls away towards the Mersey basin, where it drops to around 30m above sea level. Within the area there are four principal river valleys: the Irwell, Mersey, Irk and Medlock. Much of the district is covered with glacial till, but the river valley drainage systems have produced large amounts of drift geology of post glacial river gravel terraces and alluvium deposits. The lowlands contained large tracts of moss land, much of the area was not drained until the middle part of the 18th century.

The area of the evaluation trenching was located directly to the south of the Cloister Garden in an area that contained a stone flagged pathway close to the cloister wall and a tarmac parking area immediately beyond.



Figure 1: Gorton Monastery with the cloister garden perimeter wall located on the right.

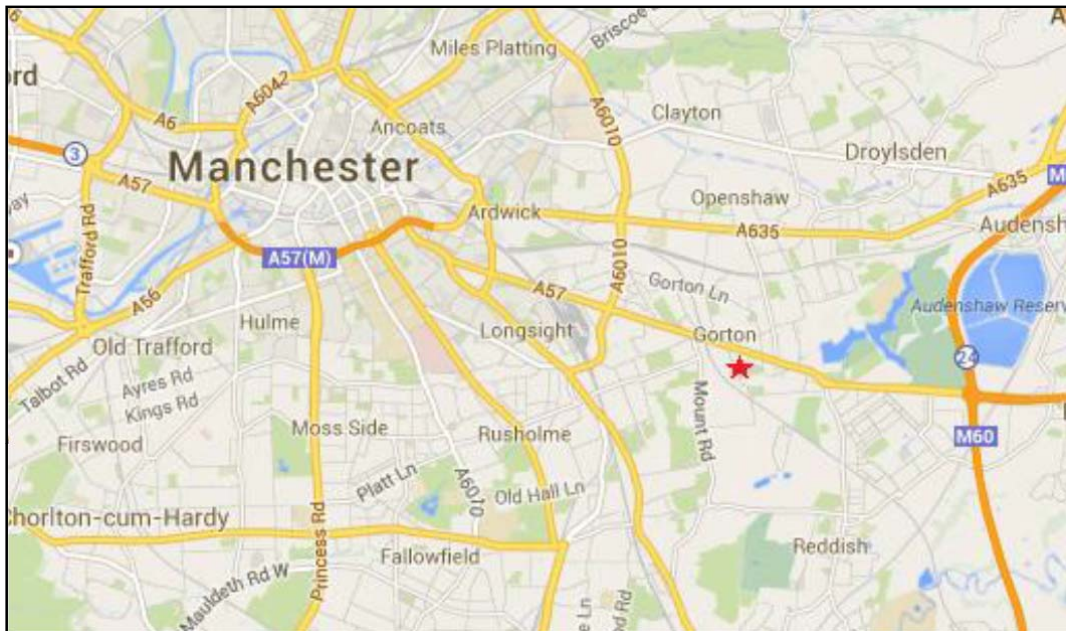

2: General location Map of Gorton.



Figure 3: Detailed location map of the Monastery.

4. Archaeological and Historical Background

4.1 Introduction

Specifically relating to this project two items of information are of direct importance. The first is the Archaeological Desk Based Assessment (DBA) produced by Kathryn Sather & Associates in March 2014 and the second is the Written Scheme of Investigation produced by Salford Archaeology and agreed with GMAAS in March 2015.

4.2 Heritage Overview

The Church and Friary of St Francis is Listed Grade II* and is considered to be one of the best examples of the High Victorian Gothic style of architecture in England. The buildings are also considered some of the best designs of Edward Pugin, a highly respected Victorian architect, and contain fine altars designed by Peter Paul Pugin. The landmark quality and dramatic impact of the buildings contributes to the importance of the site.

The site is currently owned by The Trust, which is a Building Preservation Trust, a registered charity, and a company limited by guarantee. They are in the process of undertaking further conservation works to the Church and are proposing a small new build front wing extension.

The new two storey wing will be situated to the south and east of the Cloister Garden, on the site of the former east and south wings of the Friary. These sections of the Friary were demolished in the 1970s due to their poor structural condition.

4.3 The Buildings' Origins

The earliest cartographic evidence found for the site dates to 1818. It shows the area surrounding the development site as a network of fields with sporadic areas of development, mainly to the south west of the development site.

The four-acre site purchased by the Friars in 1861 at this time is included a house, Bankfield Cottage. The development of the site for both educational and religious activities documents the growth of the Catholic population and the influence of the Church in the community.

A school chapel had been built in 1861 on Gorton Lane, near Bankfield Cottage. This chapel was used as part of the school and later became part of the Boys School. An additional building was built in 1866 for use as an Infants School and later was also used as part of the Boys School.

Other school buildings were constructed on the present site surrounding the Church and Friary. Originally, the majority of the site was laid out as a garden. The Girls School was constructed to the east of the Church on Gorton Lane in 1874 and extended in 1894 and 1902. On the west side of the site the Infants School was built in 1893 and the Parochial Hall was opened in 1897.

A tennis court had been added by 1931, and by 1957 an additional school building was in use as a Secondary School. The Friars also gave up sole use of the Cloister Garden after the Second World War so additional garden space could be used for the students. As the Friary and Parochial Hall had doubled up for use as school classrooms in times of need, the schools were used for free breakfasts and free meals for the poorer children and as a Soup Kitchen for anyone during winter and at times of prolonged strikes or industrial troubles.

By 1992 the Parochial Hall and most recent school building had been demolished and the rear portion of the garden sold off. The Girls School was at this time used as the St. Francis Youth Club, but both this building and the Infants School to the west of the Church were subsequently demolished.

The wings of the Friary were completed separately. The east wing was the first to be built. The first stone of the Friary was laid by Canon Benoit on May 24, 1863, and that same year the first wing of the Friary was blessed by Bishop Turner. As the congregation had grown larger, this wing was put into use as a chapel. The second wing was added in September 1865, parallel to Gorton Lane. The final wing was completed in 1867.

The Friary was used primarily as living and working areas for the Friars. The refectory, library, offices and reception rooms were located on the ground floor of the Friary. There was a partial basement to the north wing of the Friary, which was used as workshops. The cells for the Friars were located on the two upper floors. The Friary also contained a Retreat House, for use by both laity and clergy and guestrooms, located in the front wing. By the 1970s the east and south wings of the Friary building were in a state of disrepair and the decision was made to demolish this section of the structure.

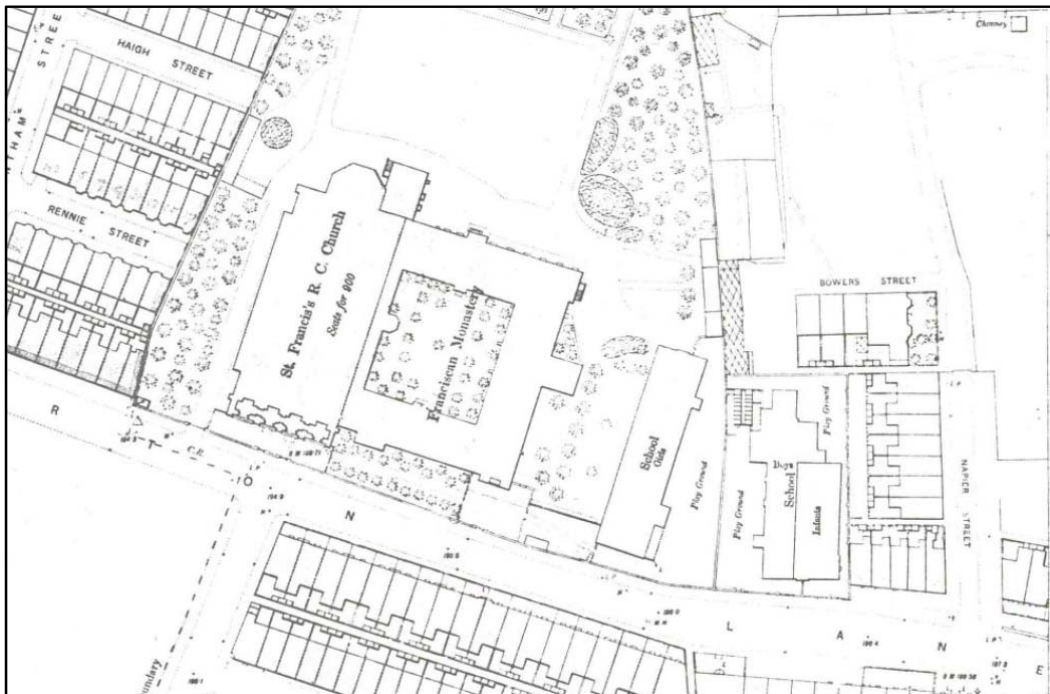

Figure 4: 1889 Map of the Church and Friary, indicating the enclosed cloister garden and complete southern and eastern wings to the cloister.



Figure 5: 1992 Map of the Church and Friary, indicating the enclosed cloister garden and minus the southern and eastern wings to the cloister.



Figure 6: The Church and Friary showing the demolished southern cloister wing in the mid-20th century.

5. General Methodology

5.1 Archaeological Evaluation

Trenching Requirements (Fig 7)

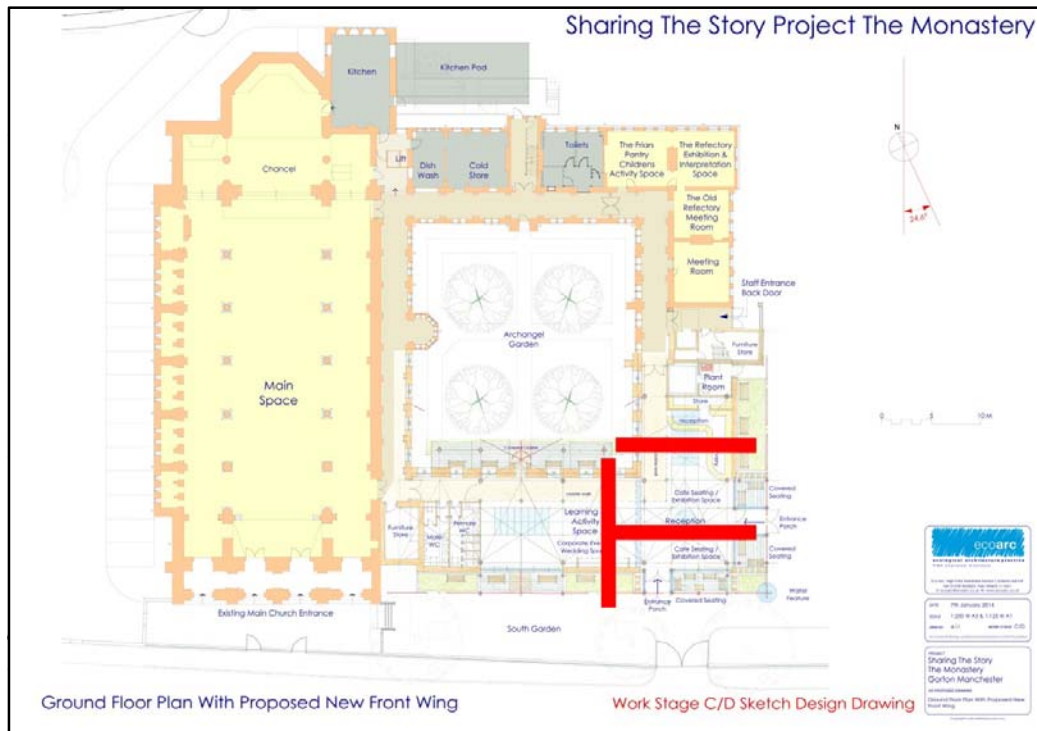

Figure 7: Development plan with the original trench locations as per the archaeological WSI

Following the DBA, GMAAS recommended that a total of three evaluation trenches were placed across the development area to determine the extent, nature and survival of potential archaeological remains relating to the southern and eastern wings of the friary.

5.2 General Aims and Methodology

Salford Archaeology (CfAA)'s detailed approach was set out in a Written Scheme of Investigation (Thompson 2015). The aim of the work was to locate any surviving archaeological deposits associated with the southern and eastern cloister range.

All archaeological evaluation was conducted following the CIFA Standards and guidance for archaeological field evaluation (Published October 1994, Revised September 2001 and October 2008).

Archaeological evaluation was undertaken by a mechanical excavator, with a pneumatic pecker to break out the tarmac areas. The stone paved areas were lifted by hand. Machining of the deposits within the trenches was undertaken by a mechanical excavator with a toothless bucket. Excavation continued until either archaeological deposits or natural geological deposits were identified. Following machine excavation, hand excavation of archaeological features and deposits occurred, followed by recording and backfilling of the trenches.

6. Evaluation Results

6.1 Actual Trench Locations (Fig 8)

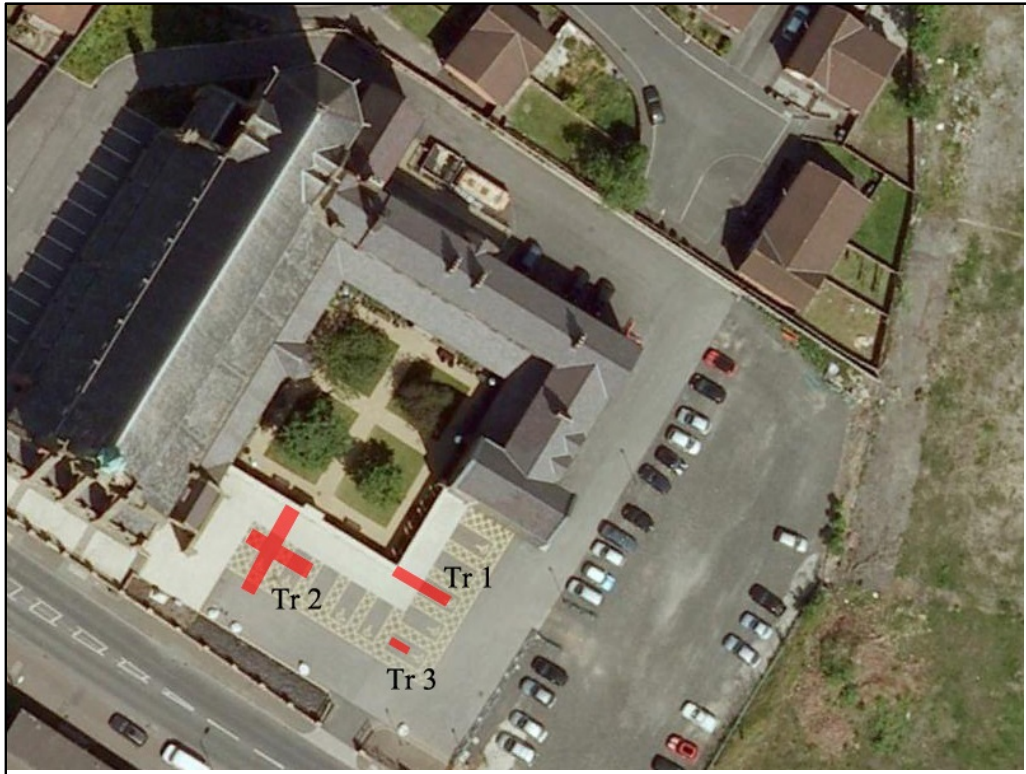

Figure 8: Google earth aerial view with actual trench locations.

6.2 Trench 1 (Figs 9-12)

The westernmost extent of trench 1 was located adjacent to the eastern cloister wall, incorporating its south eastern corner. It protruded at a 90 degree angle along an approximate eastern alignment for a total of 5m and measuring 1.90m wide.

Layer (001) was a 0.10m thick layer of firm tarmac. Beneath which lay (002), a 0.30-0.40m thick levelling deposit of angular MOT. (003) was a modern stone paving pathway, laid on a thin film of sand (004) which sat above a levelling rubble demolition layer (005), a loose reddish brown silty sand containing very frequent angular brick fragments measuring 0-0.15m. Beneath which was (006) a coarse light greyish brown sandy silt containing occasional angular 0-0.10m stone deposits. This in turn overlaid (007) a 0.15m thick humic dark blackish brown clayey sand. (007) represents the possible original layer of undisturbed topsoil material, with (009) a mixed light brown loamy sand (subsoil) located beneath an in turn sits on (010) a light yellowish brown sandy clay, (natural geology).

The original inner cloister wall (012) was identified within the westernmost extent of the trench, stepping out towards its base by two brick widths and three courses in depth. This sat on the original stone foundation layer of the wall (013) a three course, 0.30m deep stone wall with a clay bonding material and consisting of irregularly hewn stone blocks approximately 0.10m in thickness.

Two north south aligned walls, (014) and (016) were identified directly below (002) and represent the main structural walls of the eastern wing of the cloister, with (014) being a 0.80m wide stone wall, surviving for 0.65m in height and constructed from irregular sized flat stones with an average size of 0.30m x 0.20m x 0.07m thick.

Butting up to both (014) and (016) was a large structural brick wall (015). Aligned east west, 0.65m wide and surviving for a total of five courses before stepping out in half brick measurements for the final two courses, a single small abutment to the wall on the northern side was identified approximately half way along the trench. Wall (011) survived to a height of seven courses and was constructed of later handmade brick, two courses wide and bonded together with a compact greyish mortar layer and butts up to wall (014 and (012).

Brick wall (015) butted up to an existing wall foundation (016), a c.1m wide stone wall, surviving for 0.42m in height and constructed from irregular sized flat stones with an average size of 0.30m x 0.20m x 0.07m thick. Three courses of walling survived, which consisted of the foundation layers of a large stone wall, the bonding consisted of a compacted light brown clay with a rubble core existing between the faces of the wall. No artefacts were identified within this trench.

^^^



Figure 9: Trench1 looking west.



Figure 10: Trench19, looking east

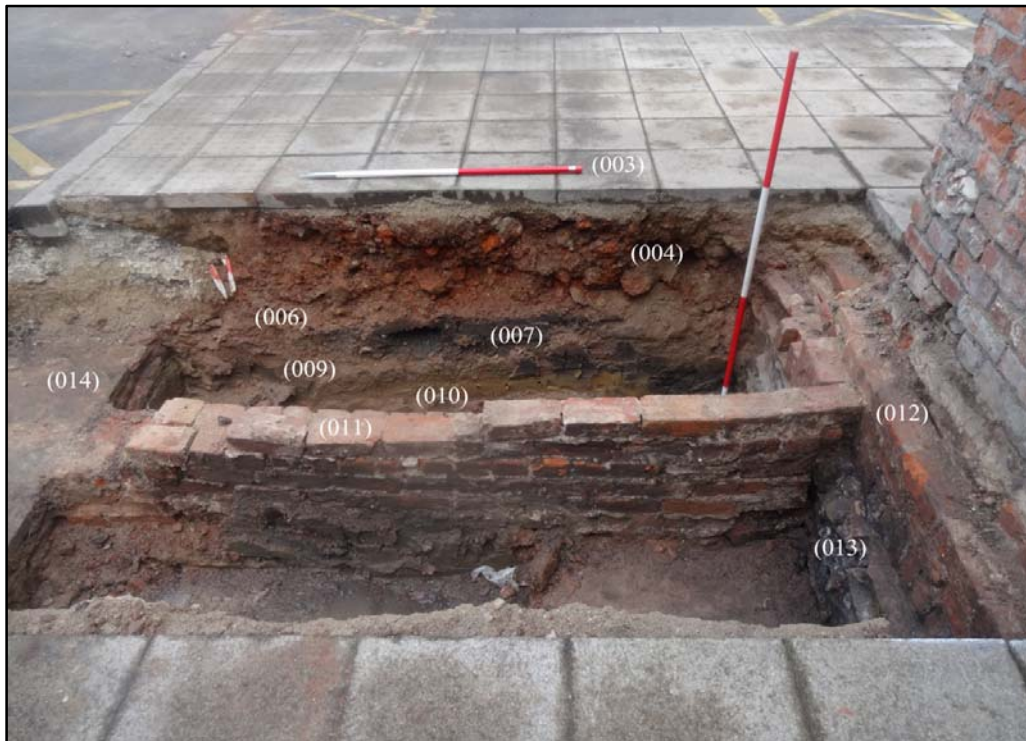

Figure 11: Trench 1, eastern extent, looking south.



Figure 12: Trench 1, centre point, looking south.

6.3 Trench 2 (Figs 13-20)

Trench 2 consisted of a cross-shaped trench orientated along the longer axis parallel with trenches 1 and 3. The west-east axis was 14m long and the north-south axis 10m long. Located within these trenches were a series of walls associated with the demolished southern cloister wing.

The northernmost arm was cut through the laid pedestrian pathway (003) and the tarmac parking area (001), beneath which laid MOT levelling layer (002). Towards the northern end of the trench layer (004) was again located and consisted of a levelling layer of the pedestrian area. Beneath which was **(031)** a mottled and mixed dark brownish black loamy deposit with frequent light yellowish brown clay lenses. Located midway through the northern arm and running parallel to the inner cloister wall was a stone wall **(018)**, constructed of a four course, 0.50m deep, 0.80m wide stone wall with a clay bonding material and consisting of irregularly hewn stone blocks approximately 0.15m in maximum thickness.

The foundation cut for the wall **[020]** was located measuring 0.20m wide from the wall on the southern side and 0.10m wide on the northern side and filled with **(019)** a mottled light yellowy brown sandy clay. **[020]** cut into layers **(007)** a dark brownish black silty loam measuring 0.10m in depth which in turn laid on **(030)** a light greyish brown silty sand measuring 0.15m in thickness and sat on the natural (010).

Located midway through the southern arm of the trench was stone wall **(023)**, identical in construction and directly parallel with (018), it was contained within foundation cut **[024]** and possessed **(025)** an identical material to with (019) a mottled light yellowy brown sandy clay.

Located along the northern extent of the western trench edge was stone wall **(022)** a five course, 0.80m deep, 0.40m wide stone wall with a clay bonding material and consisting of irregularly hewn stone blocks approximately 0.15m in maximum thickness. Bonded to (022) and located at a right angle was **(021)** a continuation of the wall (022), no thickness was identified due to the wall being identified within the western section extent of the trench.

Located within the central portion of the eastern arm of the trench was wall **(027)**, appearing smaller in stature, but parallel to (021) and butting up to the end of wall (022). Located on the western side of the wall and for a width of 0.30m was an extension of the wall. Both of which were cut by **[032]** the cut for a modern manhole access point, visible within the southern section of the eastern arm of the trench. Located across the entirety of the trench and contained by the wall was **(033)** a mixed light greyish brown mottled sandy clay debris layer with frequent inclusions of 0-0,10m rounded and sub angular stone fragments.

Throughout the excavation of the trench no floor surfaces were identified and a single find was recovered from the demolition infill (033).



Fig 13: T2 looking north-east.



Fig 14: T2 western arm looking west showing the foundations of two internal walls (012) and (022)



Fig 15: The eastern end of T2 looking west.



Fig 16: The cross-junction of T2 looking north.



Fig 17: The eastern end of T2 looking north, with [032], the intrusion and disturbance of the archaeology of the manhole inspection chamber and associated concrete surrounding (026).



Fig 18: The eastern end of T2 looking east with the foundations of wall (027) and (022) to the left, also truncated by recent activity.



Fig 19: The northern end of T2 looking west



Fig 20: The southern end of T2 looking north.

6.3 Trench 3 (Fig 21)



Figure 21: Trench 3, in the foreground

Trench 2 was undertaken as a watching brief during trial hole investigations on behalf of the engineer. Measuring 2.00m x 0.60m and continuing for a depth of 0.70m. Within the trench were (001) and (002) with (017) a light reddish brown silty sand containing frequent angular brick deposits c. 0.4m deep. This was probably a foundation or levelling layer. Natural (008) was identified at a depth of approximately 0.70m. No other archaeological deposits or artefacts were identified within this trench.

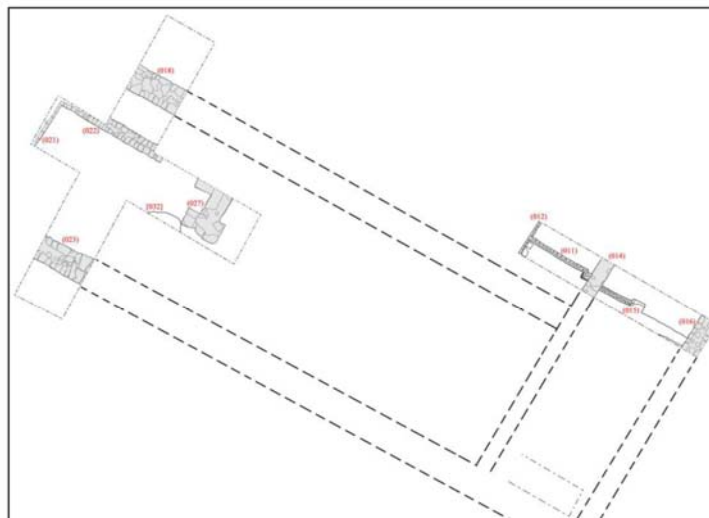
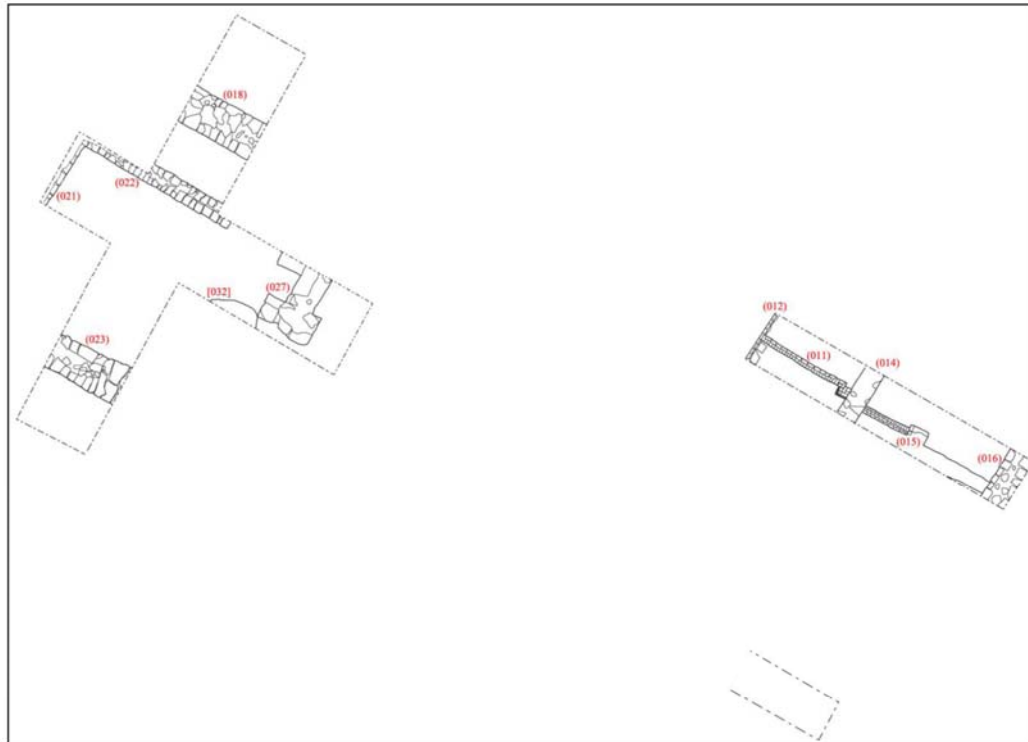

Project	Document Title	Document Type	Author	Date	Version
Gorton Monastery Evaluation	Gorton Monastery: An Archaeological Evaluation	Technical Report	A J Thompson (Director)	June 2015	1.0

Salford Archaeology

Fig 22: Overall trench plan at Gorton Monastery (top) with the outline of the southern eastern cloister ranges below.

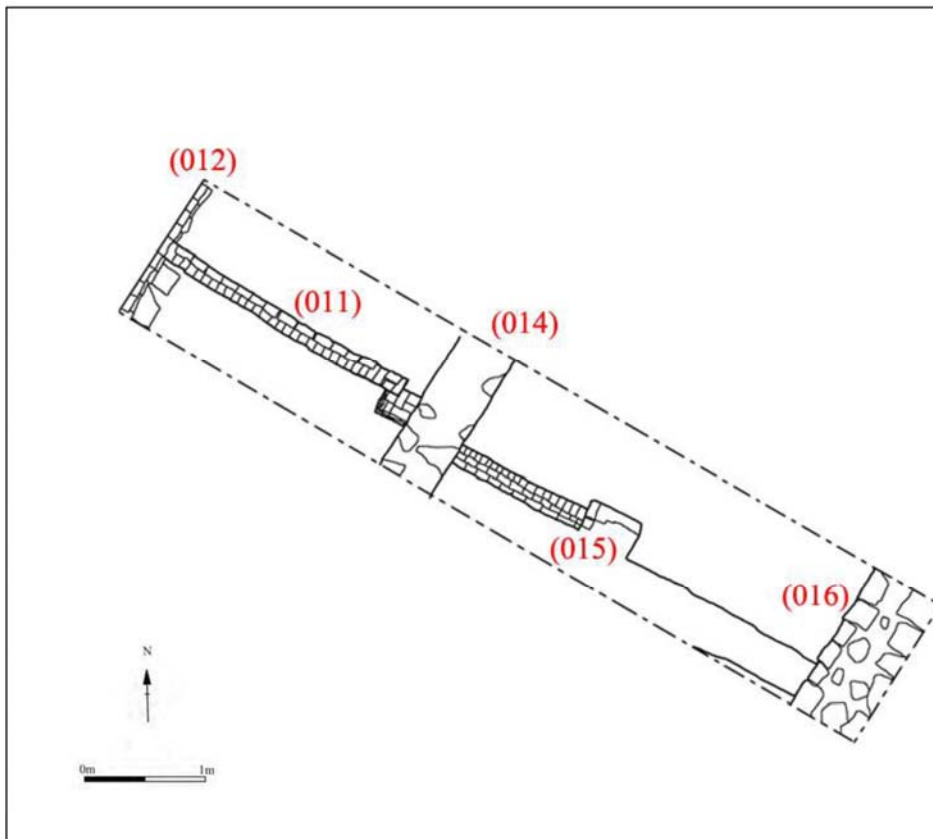

Fig 23: Plan of T1, Gorton Monastery

Project	Document Title	Document Type	Author	Date	Version
Gorton Monastery Evaluation	Gorton Monastery: An Archaeological Evaluation	Technical Report	A J Thompson (Director)	June 2015	1.0

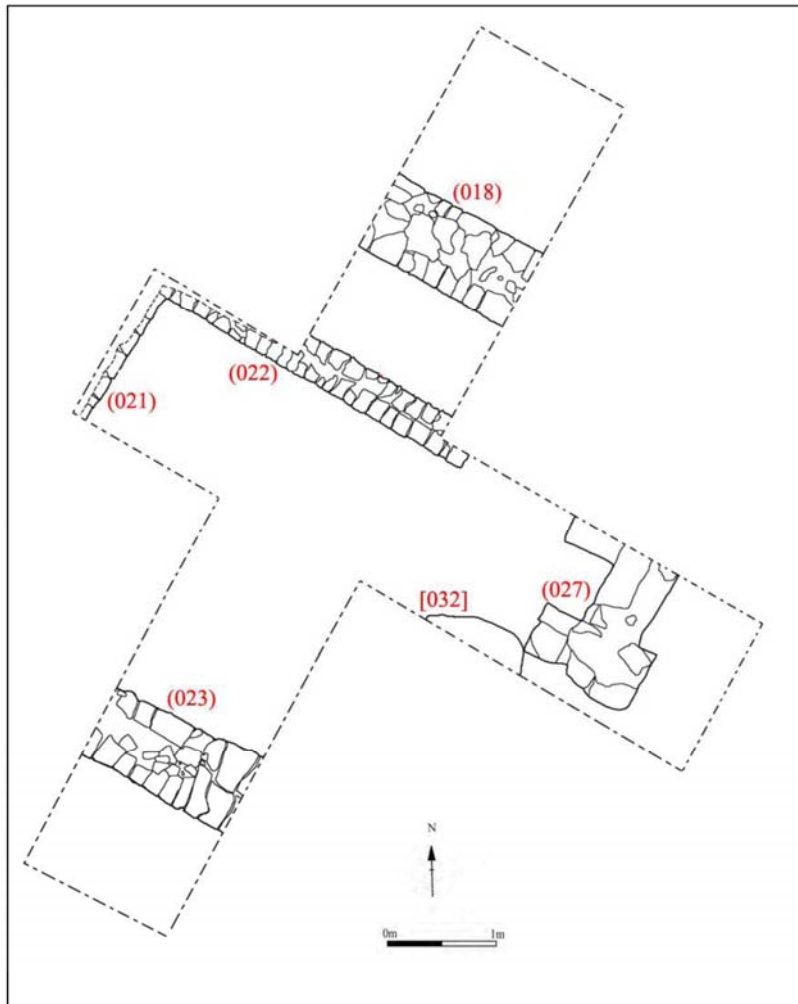

Fig 24: Plan of T2, Gorton Monastery

Project	Document Title	Document Type	Author	Date	Version
Gorton Monastery Evaluation	Gorton Monastery: An Archaeological Evaluation	Technical Report	A J Thompson (Director)	June 2015	1.0

Salford Archaeology

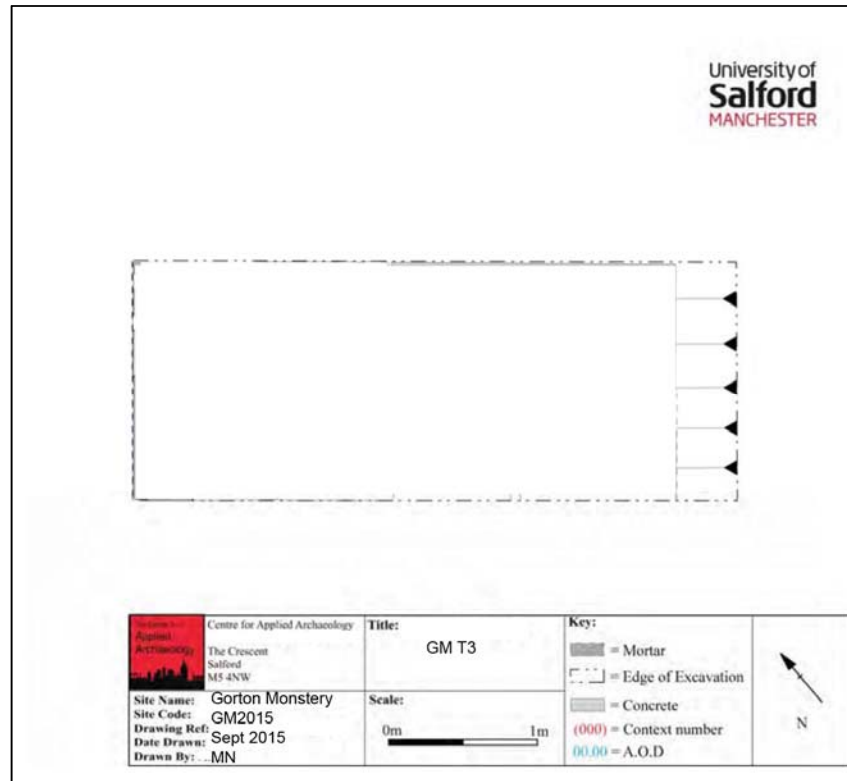

Fig 25: Plan of T3, Gorton Monastery

7. Finds Assessment

7.1 Introduction

During a programme of evaluation carried out at Gorton Monastery in Manchester during 2015, a single artefact was recovered. The item was a square-section stoneware jar of a hard buff fabric embossed with a trademark on the body and a registration mark on the base.

7.2 The Stoneware Jar (Figs 26 to 29)

The jar is 17.5cm tall and 5cm in width, weighing 322.6 grams. The fabric is stoneware with a salt glaze and square in shape. The item is complete and has an excellent level of preservation. A characteristic feature of this jar is the slightly off centre square shape, there appears to be no handle joint on the shoulder or neck of the vessel.

The inscription of the trade mark found at the base of on the body reads “*B & P Lawrence New York*” however; documentary research did not manage to uncover any further information. There is a diamond shaped registration mark on the base which, while mostly illegible, is informative. Diamond shaped registration marks were in use between 1842 and 1883.

The registration mark appears to have a “B” in the left hand segment, suggesting a possible date of 1858 according to the registration mark database (web address given below) [<http://www.nationalarchives.gov.uk/records/research-guides/reg-design-diamond.htm>]

As the registration mark is British, the trade mark of “*B & P Lawrence New York*” may be a misnomer and the item is likely to have been produced and registered within British Isles. Research on potential kiln sites for the production of this item was unsuccessful and the item is likely to have been produced by a local kiln.

The shape of the item suggests the contents may have been oils or vinegar. However, without successfully identifying similar shaped items, this is a provisional interpretation.



Fig 26: The stoneware jar.



Fig 27: The makers' stamp on the stoneware jar.



Fig 28: (above) the diamond shaped registration mark

Fig29: (left) the square-section profile of the stoneware jar.

8. Archaeological Discussion

- 8.1** The three trenches located remains associated with the southern cloister wing of the monastery (Hartwell, Hyde & Pevesner 2004, 372-3). The significant masonry foundations located within trenches 1 (016) and (014) and 3 (018) and (023) represent the foundations of the main structural walls of the eastern and southern cloister wings.
- 8.2** The internal wall (022), running parallel with (018) and (023), is probably the foundation of an internal wall which would have created a space identified as a corridor to the north. Walls (022) and (027) are the foundation layers of smaller walls which would have created internal divisions within the structure.
- 8.3** The existence of the layers loamy layers (007) and (030) indicate that prior to the construction of the southern cloister wing, the area was undisturbed, with the layers representing an earlier plough soil. The presence of (033) a rubble infill as the single deposit suggests that following the construction of the walls the inside of the building, between the foundation walls was infilled, in order to raise the ground floor to a level consistent with the remainder of the building.
- 8.4** Trench 1 located the wall remains of the eastern cloister range. These had foundations of brick, and were less massive than those of the southern range. Small internal brick cross walls were also located. Again no internal floor levels were found. Whether the difference in construction techniques represented a different phase is unclear as the junction of the two wings was not excavated.
- 8.5** The North West England Archaeological Research Framework notes that the proliferation of urban places of worship during the 19th century was a distinctive feature of the new industrial communities of the region. Many of these sites have been demolished or survive only in a partial state. Furthermore detailed recording is sporadic and certain types of site are under-recorded, or in the case of Gorton Monastery very rare (Brennand 2007, 147-8). The remains located in the current evaluation excavation demonstrate that remains of the southern and eastern cloister range survive on the site. They also show that the same care and attention to detail seen in the rest of the complex was lavished on the cloister range.
- 8.6** Salford Archaeology recommend that no further archaeological excavation is required as little additional information would be expected to be recovered.

9. Sources

Brennand M, with Chitty G & Nevell M, 2007, *Research and Archaeology in North West England. An Archaeological Research Framework for North West England: Volume 2, Research Agenda and Strategy*. Council for British Archaeology North West.

Hartwell C, Hyde M & Pevsner N, 2004, *The Buildings of England. Lancashire: Manchester and the South-East*. London: Yale University Press.

Thompson A, 2015, *Gorton Monastery. Written Scheme of Investigation and Method Statement for an Archaeological Evaluation at Gorton Monastery*. Unpublished client report by Salford Archaeology, CfAA, University of Salford.

Appendix: Context List

Context No.	Cut/Fill	Description
(001)	Fill T1, T2 & T3	Car park tarmac
(002)	Fill T1, T2 & T3	Stone hardcore, 0.3m to 0.4m thick
(003)	Stone layer T1	Stone paved pathway
(004)	Fill T1	Sand layer , foundation beneath (003)
(005)	Fill T1	Brick rubble demolition layer beneath (004)
(006)	Fill T1	Coarse light greyish brown silty sand.
(007)	Fill T1	Humic dark blackish brown clayey sand 0.15m deep.
(008)	Fill T3	Light yellowy brown sandy clay (undisturbed natural)
(009)	Fill T1	Mixed light brown loamy sand (subsoil)
(010)	Fill T1	Light yellowy brown sandy clay (undisturbed natural)
(011)	Wall T1	Brick wall, inner wall, abuts walls (012) and (014)
(012)	Wall T1	Brick wall, cloister exterior wall
(013)	Wall T1	Stone wall foundation beneath (0120)
(014)	Wall T1	Brick wall, north-south
(015)	Wall T1	Brick wall east-west

(016)	Wall T1	Brick wall, north south
(017)	Fill T2	Light reddish brown silty sand with brick deposits, c. 0.4m deep – making up layer?
(018)	Fill T3	Stone wall foundation
(019)	Fill T3	Mottled light yellowy brown sandy clay
[020]	Wall T3	Stone wall foundation cut
(021)	Wall T3	stone wall foundation
(022)	Wall T3	Stone wall foundation
(023)	Wall T3	Stone wall foundation
(024)	Fill T3	
(025)	Fill T3	Light yellowy brown sandy clay (undisturbed natural)
(026)	Fill T3	Concrete layer, late 20 th century. Associated with [032]
(027)	Wall T3	Stone wall foundation
(028)	Not used	
(029)	Not used	
(030)	Fill T3	Light greyish brown silty sand 0.15m thick
(031)	Fill T3	Mottled and mixed dark brownish black loamy deposit
[032]	Cut	Late 20 th century manhole cut

(033)	Fill T3	Mixed light greyish brown mottled sandy clay debris layer – demolitionlayer.
-------	---------	---

Contact Details

Business Address

Salford Archaeology
Centre for Applied Archaeology
University of Salford
Peel Building
Salford
M5 4NW

Contact Details

Telephone: 0161 295 3818

Email: a.thompson@salford.ac.uk

Nominated contact

Adam J Thompson BA (Hons), MA, MIFA, FSA

CONSULTANCY

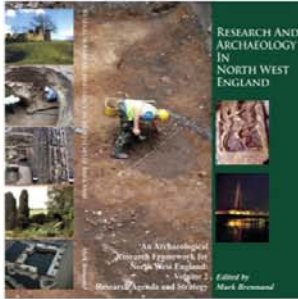

DESK BASED ASSESSMENTS



WATCHING BRIEF & EVALUATION



EXCAVATION



BUILDING SURVEY



3D LASER SCANNING

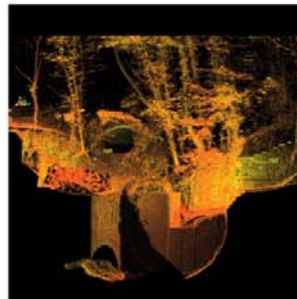

COMMUNITY INVOLVEMENT



LANDSCAPE SURVEYS

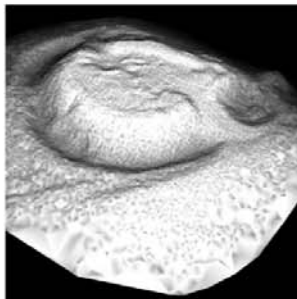

GEOPHYSICAL SURVEYS



WORKSHOPS & VOCATIONAL TRAINING



RESEARCH PUBLICATIONS

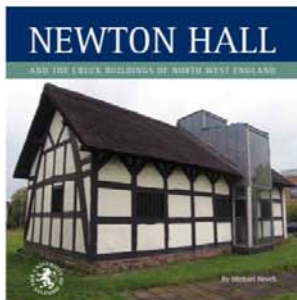

**SEMINARS, DAYSCHOOLS
CPD EVENTS**

