

Developing unification in the teaching and learning  
of jazz and classical guitar

DIEGO ENRIQUE PRATO

SCHOOL OF ARTS AND MEDIA

SALFORD MUSIC RESEARCH

UNIVERSITY OF SALFORD

SALFORD, UK

Submitted in Partial Fulfillment of the Requirements of the Degree of Doctor of  
Philosophy, August 2017

# TABLE OF CONTENTS

Author declarations	XIV
Author acknowledgements	XV
Abstract	XVI
<b>Introduction</b>	<b>1</b>
<b>Methodology</b>	<b>4</b>
<b>Chapter 1 – Contextual review</b>	<b>7</b>
The origins of the guitar	7
The oud	8
The lute	9
The renaissance guitar	11
The baroque guitar	12
The vihuela	14
The guitar in the Americas	15
Europe and the development of the classical guitar	19
Tarrega and the start of a new era of tone and technical refinement	21
The 20 <sup>th</sup> century	23
Early jazz and the development of the jazz guitar style	24
Appearance of the guitar as a lead instrument in jazz	26
A historical overview of the development of the jazz and classical guitar in the conservatoire	28

The Real Book and Fake Books and their historic role in creating a canon for jazz studies	31
An account of pedagogic theories and theories of embodiment	34
An examination of influential players and their technique	40
Classical guitarists	41
Jazz guitarists	53
<b>Chapter 2 – Literature review</b>	70
Approach to literature analysis	70
Jazz review	71
Examples of the most common type of jazz guitar method	72
Repetitive Literature	90
Fresh approaches (jazz)	91
Classical Review	102
Examples of the most common type of classical guitar method	103
Consequences of classical priorities	120
Fresh approaches (classical)	120
Final thoughts on instructional literature	130
<b>Chapter 3 – Analysis of interviews</b>	132
The reason for conducting interviews	132
The process of selection of interviewees	132
New questions emerge	133
The questions/areas of conversation	134

Question 1 – How did you start/what has been your general process of development as a guitarist?	137
Question 2 – Would you change/do anything differently, if you could go back, about the way in which you have learned and the things you have practiced?	139
Question 3 – Have you ever come in contact with the classical/jazz (as appropriate) school of playing? If so, what do you know about it?	143
Question 4 – Between the jazz and classical styles, which of the two do you think is more demanding and why?	148
Question 5 – Do you think there is currently good communication between the classical and jazz guitar genres? If not, how could we improve it?	149
Question 6 – Do you think it is important for classical players to understand the harmonic and compositional components of the music that they play?	152
Question 7 – Do you think it is possible to play both styles at a high level?	155
Observations	156
<b>Chapter 4 – A phenomenological analysis of the author’s own experience</b>	158
Introduction	158
Overview of how the classical guitar benefitted my jazz playing	159
Overview of how the jazz guitar benefitted my classical playing	161
Personal work on the classical style	162
My findings regarding the priorities of the classical guitar	166
Aspects of classical technique	167
Posture	167
The right hand	170
The note-over-pluck technique	171

The length and use of the nails	172
Developing tone	174
Independence of the fingers	175
Tremolo	176
Approaching the repertoire	177
The impact of my classical guitar studies on my jazz playing	180
Major benefits	182
Aspects of classical technique applied to plectrum-based performance	185
Personal work on the jazz style	186
Initial learning	186
Academic tuition	192
Private lessons	193
Instructional videos and master classes	193
Improvisation and harmonic understanding as priorities in jazz	194
Aspects of jazz learning and research	196
Getting the sound	197
Chord progressions and the importance of ii V I	202
How my jazz guitar studies have had an impact on my classical playing	205
<b>Chapter 5 – Conclusion (proposing a unified technique and how it might affect jazz and classical guitar syllabi in the future)</b>	<b>208</b>
<b>Introduction</b>	<b>208</b>
<b>Identifying a series of important classically-derived advances to inform jazz playing and plectrum technique</b>	<b>209</b>

Lesson 1 – Basics of sound production and sound quality	210
Lesson 2 – How classical guitarists achieve the downwards stroke	215
Lesson 3 – Long-term tone development and noise reduction	219
Lesson 4 – Avoiding unnecessary restrictions in the functioning of the upper limbs (blood-flow and musculoskeletal considerations)	220
Lesson 5 – Considerations of the axial skeleton (posture and its effect on efficient performance)	221
Lesson 6 – Efficient note transition (preparing the fingers for the next note)	224
Lesson 7 – The thumb paradox (avoiding unnecessary resistance in the movement of the left hand)	225
Lesson 8 – Extrapolating classical left hand thumb/finger balance and applying it to right hand plectrum performance in jazz	228
Lesson 9 – The application of classical rest and free (or ‘open’) strokes to plectrum technique	230
Lesson 10– Legato practice, finger strength and independence	232
Lesson 11 – Embracing the guitar’s unique possibilities (expanding horizons in harmony and tone colours)	234
Lesson 12 – The extension of the jazz player’s repertoire to classical guitar pieces with a plectrum.	236
<b>Identifying a series of important jazz-derived advances to inform classical playing</b>	241
Lesson 1 – A look into harmonic and compositional understanding as applied to the guitar (the value of understanding the composer’s idiom)	242

Lesson 2 – Chord building	243
Lesson 3 – A systematic approach to identifying and learning chord symbols	247
Lesson 4 – The importance of repositioning	256
Lesson 5 – Unveiling the fretboard	260
Lesson 6 – Introduction to modes	262
Lesson 7 – The importance of learning scales not only as finger patterns but as unique presentations of intervals, as derived from the major scale	266
Lesson 8 –Diatonic chords, common chords progressions and secondary dominant chords	271
Lesson 9 – Visualisation of rootnotes and intervals for harmonic patterns and the importance on taking material around the cycle of fifths	275
Lesson 10– Chord arpeggios and the melody/chord relationship	282
Lesson 11 – Internally modelling the fretboard through a process of mental imaging and the use of the CAGED system	283
Lesson 12 – The concept of eight-note scales as a way to control the flow of tension and resolution	286
Lesson 13–Embracing spontaneity (the value of reacting to the present moment)	290
Lesson 14 - Applying technological advances to potentially extend notions of timbre and volume	291
Lesson 15 – Tackling the issue of playing fourths on the guitar, and Robert Fripp’s <i>Paganini finger wobble</i>	297
<b>DVD – Demonstrations of some of the most important concepts described in this conclusion</b>	<b>300</b>

<b>Appendix 1 - Interview list and audio files disc</b>	301
<b>Appendix 2 – Text interviews</b>	303
<b>Appendix 3 – Improvisation experiment over a classical piece</b>	313
<b>Appendix 4 - List of players studied during research</b>	317
<b>Appendix 5 – Scores and lead sheets performed on the DVD</b>	328
<b>Reference list</b>	338
<b>Bibliography</b>	342
<b>Discography</b>	354



**List of Images**

Image 1	The Oud	8
Image 2	The lute	11
Image 3	Renaissance guitar	12
Image 4	The Baroque guitar	13
Image 5	The vihuela	15
Image 6	North American version of the European guitar	18
Image 7	19 <sup>th</sup> Century classical guitar	20
Image 8	Antonio de Torres version of the classical guitar	22
Image 9	Illegal Real Book from 1980s	32
Image 10	Legal Real Book from 2004	33
Image 11	Modern Fake Book	33
Image 12	Andres Segovia listening to Miguel Llobet	42
Image 13	Jeff Schroedl – <i>Jazz Guitar</i>	72
Image 14	Jody Fisher – <i>Jazz Guitar Complete Method</i>	73
Image 15	Ronny Lee – <i>Jazz Guitar Method</i>	75
Image 16	Les Wise – <i>Jazz Improvisation for Guitar</i>	77
Image 17	Jerry Hahn – <i>Complete Jazz Guitar Method</i>	78
Image 18	Mickey Baker – <i>Mickey Baker's Complete Course in Jazz Guitar</i>	80
Image 19	Mike Christiansen – <i>Complete Jazz Guitar Method</i>	81
Image 20	John Scofield – <i>Jazz-Funk Guitar</i>	82
Image 21	Larry Coryell – <i>Larry Coryell's Jazz Guitar</i>	84
Image 22	Joe Pass – <i>Jazz Lines</i>	86
Image 23	Joe Pass – <i>An Evening with Joe Pass</i>	86

Image 24	Mike Stern – <i>Guitar instructional Video</i>	88
Image 25	Pat Martino – <i>Linear Expressions</i>	91
Image 26	Mick Goodrick – <i>The Advancing Guitarist</i>	93
Image 27	Richard J. Nail – <i>Jazz Guitar with Classical Techniques</i>	95
Image 28	Andrew Green - <i>Jazz Guitar Technique</i>	96
Image 29	Ted Greene – <i>Modern Chord Progressions</i>	98
Image 30	George Van Eps – <i>George Van Eps Guitar Method</i>	99
Image 31	Jimmy Wyble – <i>The Art of Two-Line Improvisation</i>	101
Image 32	Dionisio Aguado – <i>Complete Guitar Method</i>	103
Image 33	Ferdinando Carulli – <i>Complete Method for Guitar</i>	105
Image 34	Charles Duncan – <i>A Modern Approach to Classical Guitar</i>	106
Image 35	Mario Rodriguez Arenas – <i>The School of the Guitar</i>	108
Image 36	Julio Sagreras – <i>First Guitar Lessons</i>	109
Image 37	Scott Tenant – <i>Basic Classical guitar Method</i>	111
Image 38	Christopher Parkening – <i>Christopher Parkening Guitar Method</i>	113
Image 39	Nathaniel Gunod – <i>Classical guitar for Beginners</i>	115
Image 40	Emilio Pujol – <i>A Theoretical Practical Method for the Guitar</i>	116
Image 41	Frederick Hand – <i>Classical Guitar Technique and Musicianship</i>	118
Image 42	David Oakes – <i>Classical and Fingerstyle Guitar Techniques</i>	121
Image 43	Eduardo Fernandez- <i>Technique, Mechanism, Learning</i>	122
Image 44	Martha Masters- <i>Reaching the Next Level</i>	124
Image 45	Goharb Vardanyan- <i>Complete Warm-up for Classical Guitar</i>	125
Image 46	Ricardo Iznaola – <i>Summa Kitharologica, Volume One</i>	126
Image 47	Ricardo Iznaola – <i>On Practicing</i>	127
Image 48	Anthony Glise- <i>Classical Guitar Pedagogy</i>	129

Image 49	Scott Tenant- <i>Pumping Nylon</i>	164
Image 50	Classical Guitar Posture (Image of Andres Segovia)	168
Image 51	Scott D. Reeves- <i>Creative Jazz Improvisation</i>	187
Image 52	Jamie Aebersold- <i>How to Play Jazz and Improvise</i>	188
Image 53	Mark Levine- <i>The Jazz Theory Book</i>	189
Image 54	<i>The Real Book, sixth edition</i>	191
Image 55	String vibration – graphic	212
Image 56	Vertical string vibration – graphic	213
Image 57	Vertical string vibration – graphic 2	213
Image 58	Plucking hand – nail length	215
Image 59	Plucking hand – nail shape	216
Image 60	Neutral position for plucking hand	217
Image 61	Plucking angle and contact specifications	217
Image 62	Example of free stroke passage	218
Image 63	Example of rest stroke passage	218
Image 64	Example of restriction of optimum functioning of the upper limbs	221
Image 65	Andres Segovia – classical guitar posture	223
Image 66	Finger preparation exercise – G major scale	225
Image 67	Left hand posture – pressing with the tips of the fingers	226
Image 68	Left hand posture – thumb position	226
Image 69	Left hand strength application example 1	227
Image 70	Left hand strength application example 2	228
Image 71	Plectrum technique - supporting upstrokes with four fingers	229
Image 72	Finger independence (left hand) image 1	233
Image 73	Finger independence (left hand) image 2	233

Image 74 Legato technique exercise	234
Image 75 Am9 chord – common voicing	235
Image 76 Am9 chord – unique open voicing	235
Image 77 Voicings from classical repertoire	236
Image 78 Dionisio Aguado study	238
Image 79 Fernando Sor study	240
Image 80 C major scale (notation)	243
Image 81 C major scale (guitar diagram)	244
Image 82 Extracting triads from scales (notation)	244
Image 83 C major chord (guitar diagram and notation)	245
Image 84 Chord notes extracted from scale (guitar diagram)	245
Image 85 Diagrams of other voicings and how to extract them from scales	246
Image 86 How to raise and lower scale notes to create other chords (guitar diagram)	247
Image 87 D/A chord	256
Image 88 Repositioning the major scale (guitar diagram)	256
Image 89 Repositioning the major scale –inversions (guitar diagram)	257
Image 90 Further repositioning of scales and chord extraction (guitar diagram)	258
Image 91 Major scale (guitar diagram)	258
Image 92 Repositioned major scale in key of G (guitar diagram)	259
Image 93 Major scale – alternative shapes (guitar diagram)	259
Image 94 Key of G – complete fretboard (guitar diagram)	261
Image 95 G major scale as extracted from full fretboard diagram	261
Image 96 G major scale as extracted from full fretboard diagram 2	261
Image 97 Major scale on one string (guitar diagram)	263

Image 98 Ionian mode (guitar diagram)	263
Image 99 Dorian mode (guitar diagram)	264
Image 100 Phrygian mode (guitar diagram)	264
Image 101 Lydian mode (guitar diagram)	264
Image 102 Mixolydian mode (guitar diagram)	265
Image 103 Aeolian mode (guitar diagram)	265
Image 104 Locrian mode (guitar diagram)	265
Image 105 Alternative pattern for lydian mode (guitar diagram)	266
Image 106 Major and harmonic minor scales	269
Image 107 Major and mixolydian scales	270
Image 108 Major and melodic minor scales	270
Image 109 C major scale (notation)	271
Image 110 Diatonic 7 <sup>th</sup> chords (notation)	271
Image 111 Moveable 7 <sup>th</sup> chords (guitar diagram)	272
Image 112 Moveable 7 <sup>th</sup> chords – roots on the 5 <sup>th</sup> string (guitar diagram)	272
Image 113 Moveable 7 <sup>th</sup> chords – roots on the 4 <sup>th</sup> string (guitar diagram)	273
Image 114 Visualisation of essential intervals (one)	276
Image 115 Visualisation of essential intervals (two)	276
Image 116 Visualisation of essential intervals (three)	276
Image 117 Visualisation of essential intervals (four)	277
Image 118 Visualisation of essential intervals (five)	277
Image 119 Visualisation of essential intervals (six)	278
Image 120 Visualisation of essential intervals (seven)	278
Image 121 Circle of fifths	280
Image 122 Circle of fifths applied to the fretboard	281

Image 123	Basic chord arpeggios (guitar diagram)	283
Image 124	Basic shapes of the CAGED system	284
Image 125	CAGED system shapes as seen on the fretboard	285
Image 126	Moveable C shape	285
Image 127	Major seventh note added to basic CAGED system shapes	286
Image 128	Eight-note scale as derived from mixolydian scale	288
Image 129	Eight-note (bebop) major scale	289
Image 130	Eight-note (bebop) dorian/minor scale	289
Image 131	Eight-note (bebop) locrian scale	290
Image 132	Fisherman amplifier	294
Image 133	Roland amplifier	294
Image 134	Fender amplifier	295
Image 135	Finger flattening	298
Image 136	Paganini finger wobble	299

## AUTHOR DECLARATIONS

During the period of registered study in which this thesis was prepared, the author has not been registered for any other academic award or qualification.

The material included in this thesis has not been submitted, wholly or in part, for any academic award or qualification other than that for which it is now submitted.

Diego Enrique Prato

A handwritten signature in black ink, appearing to read 'Diego Prato', with a stylized flourish at the end.

School of Arts and Media

August 2017

## AUTHOR ACKNOWLEDGEMENTS

I would like to thank the following people for their support, guidance and inspiration during these doctoral studies.

Dr Robin Dewhurst for supervising my work. His knowledge of music and academia have been invaluable, as has his generosity and availability.

Dr Timothy Wise for co-supervising my work, and for his encouragement.

Connoll Peavey and Luke Harrison for all their dedication and support in the filming and producing of the video demonstrations that accompany the written work.

All of the guitarists who agreed to be interviewed as part of this research project (Craig Ogden, Martin Taylor, David Oakes, Emma Smith, Anton Hunter, Alfredo Rugeles, John Harper, Brad Edmondson, Adam Palma, Steve Davismoon, Alan Williams, Jim Faulkner, Paul Cusick, Stuart McCallum, David Bainbridge, Jamie McRae, Sam Rodwell, Daniel Brew, James Girling, Matthew Campbell)

The Prato Montesinos, Martin Kerr and Rodriguez Morataya families for their support in many aspects, including the financing of this project.

All of my colleagues and friends who have contributed to this research in different ways.



# ABSTRACT

I am a guitarist who dedicates to the styles of jazz and classical music. After starting out by playing folk and rock styles during my childhood, I later gravitated towards blues and funk and eventually jazz in my late teens, when I decided to become a full time musician. Later, in my mid twenties, I developed a passion for the classical guitar and eventually made the decision to dedicate 50% of my practice time to this style and 50% to jazz. Inevitably, as a result of a serious commitment to both styles, I have had a personal experience of what their study involves, how their value systems work and what aspects of music and guitar performance they each prioritize. I have found this experience deeply interesting because they both have developed a very advanced understanding of the instrument, but in very different areas.

The first intention of this thesis is to identify what the differences are in the ideologies, teaching and learning of the guitar between the jazz and the classical genres. I then will contemplate whether a potential for an enhanced understanding of the instrument as a whole can be achieved in the future through the process of these styles each absorbing knowledge developed by the other.

The research has been undertaken in the area of literature and instructional material for the instrument, as well as through interviews with guitarists in both fields. Additionally, I have included a chapter based on a reflective analysis of my own experience as a student of both genres. In order to facilitate the understanding of why these styles have developed in the way that they have, there is also a chapter dedicated to the historical context of the genres.

Based on my findings, I have included a conclusion in the form of lessons aimed at guitarists in each style, presenting to them ways in which they can advance their understanding of the instrument based on knowledge developed within each other's schools and ideologies. Finally, I have also created a DVD to support this proposal, with relevant demonstrations and performances on the instrument.

These doctoral studies have conformed one of the most significant learning periods in my life as a musician and guitarist. I am fascinated by this subject and will continue to work on it through my ongoing research, playing and teaching. I hope that this work will help to generate more interest and research in this area of guitar playing.

## Introduction

### **The origin of my interest in the subject of the research**

As a student, performer and teacher of the guitar, I have had the pleasure of immersing myself fully into both the classical and jazz guitar genres. Firstly as a jazz guitar student throughout many years of hard work in order to fully understand the style and play it confidently, and later on as a fan of the classical guitar with a deep interest in the genre which eventually resulted in my commitment to its serious study.

Inevitably, the thorough study of both worlds has led me to compare them and to look at the ways in which they are similar and the ways in which they diverge. To my amazement, the fact that being able to play one at a very advanced level prepared me so very little for the task of playing the other made me realize that, even though the instrument is essentially the same (acoustic/electric considerations and fingerstyle/plectrum techniques aside), the player and musician that develops in order to play either genre is contrastingly different from the one that develops in order to play the other.

Nonetheless (and this was probably the main reason for my realization) the more I studied each style, the more I realized that each of these worlds had developed uniquely advanced ways of thinking about the instrument, but in different areas. In the broadest of terms, these areas were those of improvisation and harmonic mastery on the jazz side, and tone and technical control on the classical.

Each style had developed these aspects of guitar playing to such a high degree that, almost by implication, some of the other aspects of guitar and musical performance had taken a back seat. In my personal case, I learned that the classical technical and tonal knowledge that I had acquired allowed me to see possibilities in my instrument that I had never discovered through any jazz lessons or books, and that spoke about the nature of how the instrument works and behaves beyond the confinements of classical music. And likewise, the knowledge of harmony and how to respond to the

moment which I had gained through jazz was equally benefitting my playing in other genres in ways that I had never experienced within classical resources or teaching methods.

### **The development of the research question and project**

The more I continued to improve my skills in these two styles as a player, the more I was cross-benefitting from them in ways that would have been impossible had I just studied either one by itself. Some purists may say that, through this process, I may have also been further distancing myself from the *real* sound of jazz or classical music. However, for me as a player, I wanted to continue to absorb those things that made me feel more and more in control of (and better informed about) my instrument, about the guitar. In my personal case the fact is that I love both jazz and classical music in all of their forms, but feel no personal desire to stick to their established approaches (as much as they indeed are an integral part of my playing and as effective as they are in order to produce much beautiful music). Instead I want to explore how they may (most likely, if history serves us as any kind of reference) be changed in the future in order to evolve and reach new grounds that will find unmistakable tradition coupled with further techniques and sounds.

Thanks to my classical studies, technical demands that presented themselves in the jazz genre were overcome with much less effort than they had ever been before, and my understanding of how to control and produce tone colours on the instrument was much more highly advanced. In the classical genre, and as a consequence of my jazz studies, I realized that I was able to analyze and understand the harmonic and compositional structure of the music I was playing inside out for basically any new piece, allowing me to interpret it more effectively and in a way that none of the classical methods I had seen guided the student to do so. Jazz improvisation had also trained me very well to respond to the moment and to be alert to the unique organic features of any single performance, which in a classical context allowed me to add a touch of uniqueness to every single performance through the use of articulation, accentuation, tone colours and dynamics for dramatic effect in a controlled but spontaneous way.

I considered my playing in both of these styles to have benefitted in such a huge way from the study of the other that it seemed a shame that what I found to be such a major revelation was not spoken about, or reported, more often amongst the guitar community. After all, I came to rip these benefits by accident and not because I was encouraged to do so or because I could predict it happening. I was simply a lover of both styles who decided to study them in a parallel fashion.

I wanted to find out whether my experience had been unique in that I was not able to obtain the technical and tonal understanding (applicable to the performance of any music) that I acquired from the classical guitar from jazz resources; and, similarly, in that I was not able to obtain the harmonic and compositional understanding (applicable to the performance of any music) that I obtained from jazz through my classical studies. If my situation was not unique, I then wanted to contribute towards making the knowledge more readily available for guitarists in both genres.

I was at a point in my life when I considered it highly beneficial for my career to engage in PhD research studies, firstly because of my personal fascination with the study of the guitar and music, as well as for the benefit of my professional career and the desire to reach deeper levels of understanding within my field. My deep passion for this particular subject encouraged me to take on the challenge of basing my PhD around it.

The central question of the research is firstly to identify whether (beyond my personal experience) there are areas of understanding that apply to the classical guitar that are generally not covered in the teaching and learning of the jazz guitar, and, conversely, whether there are areas of understanding that apply to the jazz guitar that are generally not covered in the teaching and learning of the classical guitar. If there are, I aim to identify what they are and, thereafter, to find if a means can be developed that captures and presents these contrasting areas of knowledge in a way that may be the beneficial to the future development of both styles.

## **Methodology**

This section explains the variety of methods through which I found answers to the questions set out in the introduction to this thesis.

### **Contextual review**

To initiate the process of analysis of these styles of guitar playing, I examined their individual histories and evolution from the time leading up to their conception to the present day. As part of this section I included a study of key players and their contribution to the development of the performance of the instrument. Additionally, I explored the pedagogic history of both guitar genres, from the time before they entered the academy up to the modern day.

### **Literature review**

This section involved the analysis of text regarding classical and jazz guitar, separately. Through the analysis of instructional material for each genre, I intended to look for similarities between methods and to find out what the conventions were in the teaching of classical and jazz guitar. This in turn helped me to realize which areas of music performance and guitar playing as a whole tend to be prioritized amongst each style, as well as which tend to be given less, little, or no attention; helping to reveal potential areas for cross-fertilization.

### **Interview-based research**

I undertook a number of interviews with professional players in both genres in order to ask them questions related to the thesis (in areas of pedagogy, experience of learning in the style, their understanding of each other's genres, whether they think there is currently good communication between the two genres, etc). The most important purpose of this method was to provide a different route to finding evidence, strengthening the reliability of the overall conclusion of the thesis, as it not only

looked at information on printed material but also the spontaneous opinions of working professionals in the field.

### **Phenomenological analysis (based on my own practice)**

The vast majority of classical guitarists have very little, if any, knowledge of jazz playing. Likewise, the vast majority of jazz guitarists have very little, if any, knowledge of classical playing. This can be verified simply by reviewing the interviews with guitarists in both genres provided in this thesis, as well as through the literature analysis I have provided, which indicates the contrastingly different types of information that guitarists in each genre deal with.

Amongst the guitar community, I am in a rare position. I have dedicated many years of my life to educating myself as a jazz guitarist, later embarking on an equivalent period as a student of the classical guitar. Unlike most professionals in the field, I have the possibility of looking at both schools from the inside.

I personally considered that my own experience of being submerged inside each of these two genres as a student and advanced player for many years was of value for this thesis, and that it put me in a good position to take on such a project.

Nonetheless, the vast majority of this experience was gathered before the start of this research as a formal project, and was not in itself part of the work I have done since the start of my doctoral studies. However, as part of the work especially undertaken for this thesis, I constructed a formal reflective analysis of my own experience as a professional in these genres, directly relating it to the rest of the research and using it to reinforce the reliability of the evidence.

### **Conclusion (proposing a unified technique and how it might affect jazz and classical guitar syllabi in the future)**

The aim of this thesis was not to simply highlight the differences between two styles that have become highly advanced in their use of the guitar. It aimed to evaluate what the possibilities were for the development of a better understanding of this

instrument amongst players in both genres, through mutual embracing of the very different advances that each school has made, due to the demands of their respective priorities (generally speaking improvisation in jazz and execution/interpretation in classical).

The intention through this was not to propose a new way of approaching the guitar that will necessarily make the traditional practice of either genre better, but to offer new findings and tools for the further-development of our understanding of the instrument, its practice, and its possibilities.



## Contextual Review

### **Historical account of the evolution of the guitar and the development of the jazz and classical styles**

The purpose of this section of the thesis is to provide a historical perspective of the development of the guitar, with particular attention to the origins of the jazz and classical guitar schools and to their respective techniques. The ways in which these styles are taught and played today are a consequence of the history behind them, and the cultural, political and social environments in which they have developed over the decades and centuries. Examining the historical context of classical and jazz guitar will facilitate a better understanding of these genres; I am particularly keen to explore the correlations that exist between them, in the academy as well as the performance world.

### **The origins of the guitar**

“Though the guitar has evolved through the centuries, there is no clear thread of development, and there are plenty of evolutionary dead ends” (Yentob, 2012)

By the 17<sup>th</sup> century in Europe, there had already existed a series of stringed instruments which were very similar to what we know today as the guitar. In fact the original versions of these instruments had by that time existed for several centuries. According to Sadie (1984) instruments called *guitars* started to appear in literature as far back as the 13<sup>th</sup> century. However, what most historians refer to as the first *guitars* are instruments from the Renaissance period. All of these instruments were related and would influence the creation of the 6 string guitar with the shape and tuning which is familiar to so many of us today. “Even in some of the oldest

civilizations it is possible to find traces of instruments which are very similar to our guitar” (de la Maza, n.d.)

Some important examples of these instruments include:

***The oud***

The oud is an instrument of Middle Eastern origin brought to Europe during the Arabic colonization of Spain in the 9<sup>th</sup> century AD. It is often considered as the most important predecessor of the guitar, since it was the original instrument that would lead to the creation of stringed instruments in Europe, namely the Renaissance lute and the vihuela. “In contrast to other lutes, the oud has survived from these ancient origins, traveled to other parts of the world, and had a great influence on instruments such as the Chinese pipa, Japanese biwa, and European lute”. (Haverstick, 2015)



The Oud. Image 1

“The oud is one of the oldest stringed instruments in the world, and likely originated in Southern Mesopotamia (modern Iraq). It dates back to at least 3000 BC. The popularity of the oud spread throughout the Middle East, Mediterranean and Northern African regions, as well as into Central Asia. The oud has existed in its modern form for well over five hundred years. Most modern western stringed instruments (such as the mandolin, the Renaissance lute and the guitar) are descendants of the oud” (Romer, 2015).

The most popular conception of the instrument features eleven strings, the highest ten of which are tuned in pairs and are plucked individually to produce melodic lines. Its tuning, size and appearance can have many variations depending on the country, region, era and local tradition. The main two branches of the oud are the *Arabic* and the *Turkish*. These two versions are usually tuned in the following ways:

Arabic (from low to high): C F A D G C

Turkish (from low to high): E A B E A D

An important feature of the oud is that it does not have frets. This allows the player to bend notes, decorate and articulate melodies in ways that are distinctly different from those used in the European tradition.

### ***The lute***

According to Kennedy, M and Kennedy, J. (2006, p. 452) there is an early version of the instrument known as the *long lute*, which has a neck longer than body, and dates back to 2000 BC at least. Another version with its neck slightly shorter than body is known as the short lute, and dates back to around 800 BC. “Plucked string instruments with long necks and relatively small bodies are thought to be of considerably greater antiquity than those with short necks. Long neck lutes are found depicted on Mesopotamian seals dating as far back as the period 2340-2198 BC, and appear in ancient Egyptian iconography” (Spring, 2001, p. 1).

Interestingly, according to my research (and as seen on quotes above), the word lute is at times used broadly to refer to many different ancient plucked string instruments. For example, Spring refers to the previously mentioned *oud* as a type of lute “One of the most successful and long-lasting short-necked lutes is the Arabic oud” (2001, p.1). The earlier versions of the oud were “transformed into the European lute, with distinct neck and central soundhole, probably in Spain in the 14 century. It has a round body, like halved pear, flat neck with seven or more frets, and a separate pegbox usually bent back from the neck at an angle” (2006, Kennedy, M and Kennedy J. p. 452)

Before then the Arabs had introduced the oud to Europe ~~Europe~~ via Spain, during their rule of the country, which started with the invasion of Tariq ibn Ziyad in the 8<sup>th</sup> century AD from North Africa to southern Spain (Conde, 1900, p.53). This, most widely known, version of the lute reached its highest period of popularity in Europe during the Renaissance period and until the 18<sup>th</sup> century, with composers such as John Dowland, Bach and Handel writing for the instrument. It was also a popular instrument for domestic use during this time. This version of the instrument, often referred to as the *Renaissance* lute, had several variations and evolutions in string numbers and tuning, sometimes reaching up to 30-35 strings. A common version, however, had eleven strings, the lowest ten of which were tuned in pairs. It held the following tuning from low to high: G-C-F-A-D-G.

Since the second half of the 20<sup>th</sup> century, there was a revival of interest in the performance of the lute (in no small part thanks to Julian Bream – one of the most celebrated classical guitarists of the century – and his use of the instrument in famous performances and recordings). This has brought back to the lute music which was originally written for it, that had mostly only been heard in adaptations for the classical guitar in the previous decades and century.



European Renaissance lute. Image 2

### ***The renaissance guitar***

The most common Renaissance guitar was a four course instrument with three double lower strings and a single top string. Unlike the lute, the vihuela or the baroque guitar which came later, the renaissance guitar was used mostly for accompanying purposes. Players would strum chords and create a harmonic background for song and dance. The renaissance guitar also had occasional different tunings depending on the location.

“The Renaissance guitar was a fusion of two instruments which developed in the middle ages in the Iberian Peninsula - the Moorish guitar, descendant from the Arab invasion (of Spain), and the Latin guitar, which originated as an evolution of instruments from Ancient Greece. It travelled through the central part of Europe and moved through the north until arriving at the Iberian Peninsula” (Casanova, 2014)

The size of this instrument is smaller than most other predecessors to the modern guitar, and its sound more gentle, ideal for domestic use. As with many instruments and items in the period, apart from its musical use, the Renaissance guitar had a purpose of visual pleasure and ornamentation. Interestingly, this instrument seems to have naturally evolved over the decades into what would formally establish itself as the five course Baroque guitar in the 16<sup>th</sup> century.



Renaissance guitar. Image 3

In 1555 Juan Bermudo wrote in his *Declaracion de Instrumentos Musicales* (*Declaration of Musical Instruments*): "We have seen a guitar in Spain with five courses of strings." Bermudo later mentions in the same book that "Guitars usually have four strings," which implies that the five-course guitar was of comparatively recent origin, and still something of an oddity" (Anne Evans, 1977, p. 24).

### ***The baroque guitar***

"The Baroque guitar falls midway between the two extremes of using the instrument to produce pure art music, and as a means of strummed accompaniment" (Turnbull, 1991. p. 61).

With a development period that started in the late 16<sup>th</sup> century and lasted until the 18<sup>th</sup> century, the baroque guitar often had nine strings of which the lowest eight were tuned in pairs (five courses). However, there are also versions with all courses in pairs. The instrument would evolve to have different variations in its tuning. However, most of them were based on the series (from high to low): E-B-G-D-A, with the D and

A being on the same octave as the E, B and G. Much like its predecessor, the lute, this instrument became popular for domestic use.



Baroque guitar. Image 4

“A certain mystery surrounds the emergence of the five-course Baroque guitar. Towards the end of the 16<sup>th</sup> century, this species of instrument became fashionable in several European countries, retaining its popularity for the best part of two centuries. In Spain, the belief arose that the fifth string of the guitar had been originated by Vicente Martinez de Espinel (1550-1564), poet, novelist and musician”. (Wade, 2001. p. 17).

The baroque guitar was often used as an accompanying instrument that provided harmonic backing and single melodies in song and dance. It is particularly interesting to see how this instrument starts to become more similar to the modern guitar. This can be observed in its tuning- which follows the same order as the first five strings of the modern guitar (E-B-G-D-A), as well as in its size and shape, which are closer to it than previous stringed instruments. Although it did not receive the same amount of serious attention as the previous vihuela did, it was however considered by some an instrument of great potential beyond the accompaniment of popular pieces. During a

video documentary about his life as a musician, Julian Bream (2003) spoke about his time playing the Baroque guitar: “Although it only had five strings, it seemed to me perfectly complete. The actual sound of the baroque guitar encapsulates the feeling of the 18<sup>th</sup> century; it sounds like a young harpsichord”.

### ***The vihuela***

A similar instrument to the Renaissance lute, the vihuela had six double strings and was tuned G-C-F-A-D-G. It was most popular in Spain during the 15<sup>th</sup> and 16<sup>th</sup> century, whilst also being played in Portugal and Italy, where the instrument was referred to as the *viola de mano* (or *viola of hand*). Like its contemporary, the lute, the vihuela was often used to compose and play polyphonic and contrapuntal music. This instrument would influence the development of the techniques that would eventually find themselves in use on the modern classical guitar. Some of its most important performers and teachers were Luis Milan, Alonso Mudarra and Luis de Narvaez. “Luis Milan’s *El Maestro* represents one of the first examples of an instructional method for a fretted instrument. Many of the problems dealt with in this text can be found, in one form or another, in guitar methods ever since” (Wade, 2001. p. 23)

Referring to the development of a technique and style of playing which was more advanced than those used on previous guitars, the influential Spanish classical guitarist Regino Sainz de la Maza (for whom the famous *Concierto de Aranjuez* was written) said in an interview for Spanish national television “The vihuela players of the 15<sup>th</sup> and 16<sup>th</sup> century are the ones who took the vocal polyphony to the guitar” de la Maza continues “The vihuela is the most immediate predecessor of the guitar” (n.d.).





The vihuela. Image 5

It is important to mention that these previous instruments not only played an important part in the development of the modern guitar as we know it today, but their influence continues to be felt in a direct way as far as the repertoire for the instrument is concerned. Much of the music originally written for these older instruments has been transcribed for the modern guitar, partly due to a revival of interest in this music since the 1960s in Europe. There are many major classical guitar performers who often include this music in their repertoire. Some examples are Cesar Amaro's interpretation of *Fantasia* by Alonso Mudarra (1510-1580) originally written for the vihuela; Nataly Makovskaya's interpretation of *Lacrimae Pavan* by John Dowland (1563-1626) originally written for the lute; John Williams' interpretation of *Canarios* By Gaspar Sanz (1640-1710) originally written for the baroque guitar; and Andres Segovia's interpretation of *Guardame las Vacas* by Luis de Narvaez (1530-1550) originally written for the vihuela.

### **The guitar in the Americas**

Once the plucked string instruments of Europe were introduced to the American continent through the European Colonization process in the 15<sup>th</sup> and 16<sup>th</sup> centuries, they started to have an evolution of their own in this part of the world that was

different to that which it continued to have in Europe. In the Americas, the cultures of Europe made direct contact both with the cultures of the local indigenous people, as well as those of the African people who were brought to the Americas as a result of the slave trade. This would have a great impact on the development of music and musical instruments throughout the American continent.

### *Central and South America*

The areas of the American continent colonized by Spain and Portugal (the vastest part of South and Central America) had a different kind of evolution of culture than the areas colonized by the British (mostly North America). As a result, the evolution of the guitar in these areas was particularly different.

Anthropologist Robert Garfias (2012) says in an interview “Both Spain and Portugal are different from the rest of Europe, probably because of the long lasting influence of the Arabic culture in the Iberian Peninsula. It made the cultures of the region different. It changed the language, it affected the architecture, it affected the food, and it certainly affected the music”.

Given that the colonization process started in the 14<sup>th</sup> century, the development of new string instruments in the Americas started centuries before the classical guitar as we know it today was invented in Spain, in the 19<sup>th</sup> century. The Spanish first brought with them instruments such as the aforementioned Renaissance guitar, the vihuela and the Baroque guitar, all of which were double course instruments. Directly from these instruments there developed, in Central and South America, new double course instruments including the Cuban *Tres*, the Colombian *Tiple* and the *Charango* (which was present across the whole of the Andes region).

More instruments eventually evolved later, at times using single courses. Some examples of these are the Venezuelan *Cuatro*, the Venezuelan *Bandola*, the Mexican *Requinto* and the Brazilian *Cavaquinho*. All of these derive from the instruments brought by the Spanish and Portuguese from the 15<sup>th</sup> through to the 19<sup>th</sup> century. They continue to be used today solely in folk and popular music settings either to strum chords or play single melodic lines.

After the popularisation invention of the single course, six string guitar in Spain in the early 19<sup>th</sup>-century between the last three decades of the 18<sup>th</sup> century and the first three decades of the 19<sup>th</sup> century, this instrument became adapted to the folkloric music of the colonies as well as that of Spain and Portugal. From this point on the former, now mostly independent, colonies would embrace the modern Spanish guitar (usually referred to as the 'classical' guitar), incorporating it to their own cultures and, later, participating actively in the subsequent gradual acceptance of the instrument into the classical music community.

### *North America*

Prior to the 20<sup>th</sup> century, the guitar did not enjoy the supreme popularity that it eventually did in North America. At that time the population of this area remained mostly culturally connected to Great Britain. The most common music was folkloric music that had been brought to America by Irish, Scottish and English immigrants. The instrument which enjoyed the greatest popularity at this time was the fiddle, and it remained so for most of the 19<sup>th</sup> century.

“No other instrument was more important or ubiquitous at this time than the fiddle. It was found in both urban and rural areas, in all geographical regions. The fiddle was sufficiently respected that several politicians campaigned with it. In 1878, for instance, “Fiddling Bob”, Taylor of Tennessee, a decided underdog, won a seat in Congress in large measure because of his fiddling” (Nichols, 1998, p. 141).

The guitar was not usually featured in bands either. Nichols continues “Bands usually consisted of two or three fiddlers and occasionally one or two other instruments, such as the flute, clarinet or banjo” (p. 141).

The first guitars to be made in the United States in great numbers were crafted in the 1830s by the family of German immigrant Christian Friedrich Martin in New York. These, however, were made following the model of the aforementioned European single-course six string guitar. Not long after in the same decade, the same maker would start to produce a different kind of instrument. According to Gruhn (2012), the Martin Company took the job of making a guitar that was truly American in ideology

and design. This new guitar would have steel strings as opposed to the gut strings used on its predecessor and, gradually, its construction would change and grow in size in order to produce more volume when accompanying singers, sometimes several of them. However, it is interesting to see its similarity to the European *classical* guitar played at that time (of which there is an image later in this chapter).



Example of the first North American versions of the European guitar, with steel strings, by the Martin Company. Image 6

Another name which became important at this time was that of the son of an English immigrant to the United States named Orville Gibson, who also made major contributions to the development of the American guitar, creating the famous Gibson Company. “Most of Gibson’s guitars, in contrast to its competitors, were large and bulbous in design, which together with the carved bodies gave unprecedented tone and volume which was later to become so valuable in the big band era to come after his death” (Achard, 1991, p. 3).

These historical circumstances had a direct impact in the way that North, Central and South America would incorporate the guitar into their respective cultures in the following century. Latin America would maintain the practice of several of the

instruments originated in its region from the older European string instruments, whilst also heavily joining in the practice of the latest single course six-string Spanish guitar (what we now know as the classical guitar). North America, on the other hand, mostly concentrated on the use of its own steel string, wide-bodied adaptation of the guitar. This is, of course, a generalization, since the ongoing process of globalization that started in the 20<sup>th</sup> century has made it possible for all of these types of guitar to be available and in use in all regions of the world.

### **Europe and the development of the classical guitar**

In Europe, and particularly in Spain, the 18<sup>th</sup> century had seen a decline of interest in plucked string instruments as vehicles for serious art music. However, the 19<sup>th</sup> century brought with it some renewed enthusiasm. Four major figures of this movement were Spanish Fernando Sor and Dionisio Aguado, and Italians Fernando Carulli and Matteo Carcassi, all of whom were esteemed players, composers and educators. They were the first major players of the single course six string guitar with its extended range as we know it today.

This is indeed the same kind of guitar that the Martin Company adapted to make the steel string American version in the 1830s. It started to appear in Spain in the last decades of the 18<sup>th</sup> century. As Harvey Turnbull explains, “Six course guitars with such an extended tuning became established in Spain at some time before 1780” (1991, p. 63). However this instrument became mostly associated with the 19<sup>th</sup> century, in no small part thanks to the work during that time by the aforementioned musicians, all of whom published their influential guitar methods between 1810 and 1843.



19<sup>th</sup> Century Classical Guitar (Also occasionally known as *Romantic* guitar).

Image 7

Carulli and Sor, together with some other influential players and teachers, such as Dionisio Aguado and Mateo Carcassi, were concerned with the composition and performance of what we now call the classical guitar repertoire. As writers, they used many of the advanced techniques of the most accomplished composers that had come before them such as counterpoint, modulations, form and thematic development. As performers they made advances in areas such as posture, efficiency of technique and quality of sound in more depth that had been done before. In the area of education, they published methods that to this day are very influential amongst the instructional literature for classical guitar. These methods include the *Complete Method for Guitar* by Dionisio Aguado and the equally titled *Complete Method for Guitar* by Fernando Carulli. They started a process that would lead to formally establishing the instrument in the Western Classical Music world which would finish in the first half of the twentieth century with the work of guitarists

such as Andres Segovia and Regino Sainz de la Maza. However, at this stage, this movement was still in its infancy and the guitar did not enjoy anywhere near the amount of acceptance it does today.

“Aguado’s real achievements were neglected for more than a century after his death as guitarists regarded him as primarily useful for the provision of pedagogic material rather than as a composer worthy of the concert hall. This changed in the 1980s when Julian Bream paid appropriate homage to Aguado with performances and recordings”. (Wade, 2001. p. 82).

Once these first important figures had died it wasn’t clear whether the movement they had started would endure, as major interest in the guitar declined once more in the second half of the 19<sup>th</sup> century in Europe.

### **Tarrega and the start of a new era of tone and technical refinement**

The next major name to appear in the development of the classical guitar was that of Francisco Tarrega, in the second half of the 19<sup>th</sup> century. Born in 1852 in Villareal, Spain, Tarrega is credited by most as being responsible for creating what is considered to be the modern technique for the classical guitar, many basic principles of which still remain as the foundation of contemporary technique. One of the most celebrated guitarists of the 20<sup>th</sup> century, Alirio Diaz (disciple of both Segovia as well as De la Maza), mentioned in an interview “I am a consequence of Tarrega” later adding “Barrios (one of the most well known classical guitar composers/players of the 20<sup>th</sup> century) had Tarrega’s technique” (2003).

Much like Fernando Sor and Fernando Carulli took the job of integrating the classical style into the guitar, Tarrega is widely regarded as having done an equivalent work during the romantic period. His pieces remain today some of the most popular in the classical guitar repertoire (including *Recuerdos de La Alhambra*, *Lagrima* and *Capricho Arabe*), and the technical advancement that they represented from the repertoire which existed prior to them played a major part in the gradual acceptance

of the guitar as an instrument worthy of the classical concert hall. Tarrega and his compositions introduced a more meticulous use of fingerings that had been done before and showed a real deep study of the instrument's sonic and tonal possibilities.

In this sense Tarrega is indeed the first major figure to place such emphasis on tone refinement and technical control for the classical guitar. Apart from his compositions and technical achievements, Tarrega also used an updated version of the modern 19<sup>th</sup> century guitar, made by the Spanish luthier Antonio de Torres. Torres was the first to introduce the latest, bigger dimensions of the classical guitar that we still use today (although the instrument as such was still the same one played by Sor and his contemporaries in the early 19<sup>th</sup> century).



The Antonio de Torres (*modern*) version of the Classical Guitar. Image 8



## The 20<sup>th</sup> century

The 20<sup>th</sup> century has been undoubtedly the one that has seen the classical guitar established itself solidly in the serious classical music world and academy. The vast majority of well respected classical conservatories in the world now have guitar curriculums and the numbers of highly trained classical guitarists has grown significantly. This is in no small part thanks to the work of individuals such as Andres Segovia and Regino Sainz de la Maza, amongst many others, in the first half of that century.

For his part Segovia took the task of commissioning several composers (such as Villa Lobos, Castelnuovo Tedesco and Moreno Torroba) to write new music for the instrument, expanding the repertoire greatly and arriving at some of the most noticeable compositions for the instrument. Segovia also transcribed and arranged compositions originally conceived for piano, cello and other instruments for the guitar, also arriving at some of the most well-known pieces in the instrument's repertoire (such as *Asturias* by Isaac Albeniz, originally written for piano, which is arguably the most popular piece in the instrument's repertoire), and finally as a teacher Segovia had as pupils some of the most successful players of the second half of the 20<sup>th</sup> century, including Alirio Diaz and John Williams.

De la Maza was also highly influential in the 20<sup>th</sup> century, performing extensively internationally and being the central figure in the conception of what is to date the most well known guitar concerto in history – The *Concierto de Aranjuez*, dedicated and written especially for De la Maza by Joaquin Rodrigo in 1939. De la Maza also contributed to the expansion of the instrument's repertoire with compositions such as *Zapateado* and *Alegrías* amongst the best known. Apart from his contribution as a performer and composer, his work also saw him investigate the history and background of the guitar, and in 1955 he published a book titled *La Guitarra y su Historia (The Guitar and its History)*.

Of course, many other major players and composers also helped bring the classical guitar to the status it now enjoys amongst the classical music community which

(although still lower in attention compared to the violin or the piano) seems more secure than ever before. Amongst many of them Emilio Pujol – who took the job of making sure that Francisco Tarrega’s developments for the instrument were saved for posterity with his teachings and instructional publications; Ida Presti – who developed great advances and techniques in the understanding of the physical considerations of playing the instrument and maximizing its potential for sound projection (creating the sometimes called *Ida Presti* or *Presti* technique); Alexandre Lagoya – who likewise worked heavily in the projection of sound as well as advanced understandings for hand posture; Miguel Llobet – who apart from composing for the instrument, taught Andres Segovia and had a significance influence in his technique; Antonio Lauro – who amongst other Latin American composers took the classical music of that continent through the guitar to the most highly respected concert halls in the hands of Segovia, John Williams and Alirio Diaz; Agustin Barrios Mangore, who is regarded by many as the greatest classical guitar performer/composer of all.

### *Early jazz and the development of the jazz guitar style*

African American jazz saxophonist Sydney Bechet talks about his grandfather- “Sundays, when the slaves would meet – that was their free day – he beat out rhythms on the drums at the square – Congo square as they called it... he was a musician. No one had to explain notes or feeling or rhythm to him. It was all there inside him, something he was always sure of” (Gioia, 2011, p. 6).

Certain sensibilities that would be at the core of the eventual development of jazz are expressed in this statement. The jazz musician evolved through a process of self-tuition, being able to learn music by ear and to develop a strong feeling for the music were always vital elements as the notes and rhythm were perceived and performed instinctively, often without notation. There was a sense of community, of people with things in common and who shared a background. However, these are just some one of a series of elements and circumstances which led to the conception of the style.

This genre started to develop gradually in the south coast of the United States, particularly the city of New Orleans, between the second half of the 19<sup>th</sup> century and the start of the 20<sup>th</sup> century. Since its foundation in 1718, this city had been under the control of French, Spanish and, eventually, American governments. Apart from this, around eight percent of the population was of Anglo-American origin. The city absorbed elements from all of these cultures and became a diverse melting pot from which, among other styles of music and art, jazz would emerge. The main components for the musical fusion that would receive the name jazz were the rhythmic sensibilities of African music and dance, with the harmony and instrumentation of European music taken to the region.

Early musicians in the style used instrumentation derived from military bands, including drums, wind and brass instruments such as the snare drum, the clarinet and the tuba. By the mid 19<sup>th</sup> century, some slaves of African origin who were in the category of *house-slaves* (as opposed to field-slaves, working in plantations) were allowed to become part of brass bands that would participate in military parades. Since New Orleans was a former French colony, these bands were still heavily influenced by the French style of military brass bands. This influence in instrumentation, as well as their harmonic and melodic style became another essential ingredient in the conception of early jazz. These kinds of bands became more and more popular throughout the United States. Stearns (1958), says that bands were main attractions at all types of events from parades and dances to funerals and, in 1871, thirteen African American New Orleans organizations had a band each to represent them at the ceremonies for president Garfield's funeral.

These bands and groups gradually would evolve and so would their repertoire, eventually incorporating their members influence into the music that they played. African American secret societies also played an important role in this development, providing support and protection to their members in areas such as employment and welfare, including employment for musicians. The invention of recording in the early 20<sup>th</sup> century played another vital part in the development of this music, and particularly the role of the guitar in it.

### *Appearance of the guitar as a lead instrument in jazz*

In early recordings of bands, the string instrument that is most frequently used is the banjo. Its sound when strumming was louder and would cut through the rest of the instrumentation much better than the acoustic guitars of the time were able to.

“Reliable studio (banjo) practitioners like Fred Van Eps, Vess L. Ossman and Olly Oakley were especially in demand, and by the time of the Great War they and scores of other banjoists in the United States, Britain and elsewhere had recorder hundreds, possibly thousands of rags, marches, cakewalks, ‘coon songs’, and light classical pieces. The guitar, by contrast, was 26ydian, though the picture began to change in the early 1910s with the discovery that one type of playing could be successfully transferred to the half-pound shellac discs of the time: the shimmering legato times of the Hawaiian guitarist, playing with the instrument flat on the lap, making the strings sing by swooping up the fretboard with a steel bar” (Alexander, 1999, p. 5).

Steel bars, bottle necks, and several other devices were used to put into practice this Hawaiian technique. And although it originated in Hawaii, by the 1920s it had become the most popular way to play, and record, any American guitar music. For example, in 1923, the first guitar solo recording by any African American musician was made by Sylvester Weaver in this style.

Other experiments were made at the time in order to get the guitar to sound louder and more prominent. Amongst these were hard plucking styles, the use of 12 string guitars, the invention of the Resonator guitar (with contained an acoustic in-built cone that acted as an amplifier) and also the use of the guitar-banjo (a banjo with a guitar neck and six strings), which can be heard on Louis Armstrong’s *Hot Five*.

It was with Armstrong that one of the most important guitarists that would affect the future of the instrument would work. Lonnie Johnson played a fully acoustic guitar, but incorporated loud picking and also had the job of playing melodic lead parts, appearing on several recordings with Armstrong including *Hotter Than That* and *I’m Not Rough*, both recorded in 1927. Later Johnson would also play with the Duke Ellington Orchestra and the Chocolate Dandies.

Another important and influential figure at this time was guitarist Eddie Lang. Lang performed with many of the most renowned musicians of the time including Bing Crosby. His *comping* (or accompanying) style was also very influential, as he used more advanced chords and harmonies than were usually used before his time. However, the guitarist who would be given the biggest credit for transforming the guitar into a lead instrument in the jazz world was Charlie Christian.

During the late 1940's, musicians including trumpeter Dizzy Gillespie and saxophonist Charlie Parker pioneered the emerging bebop style of jazz in New York. This style was based on smaller ensembles of usually four to six people who would improvise over chord progressions which were more advanced than those of the previous jazz eras. Harmonically, these compositions were mostly based on ii-V-I chord progressions, and made regular use of modulations through methods such as tritone substitution and secondary dominant chords. The soloing style they used was based on the idea of delineating the harmony of the music in melodic improvisations, whilst decorating it creatively with devices such as chromatic and intervallic ideas, as well as rhythmic complexity. Charlie Christian was the first major guitar player to play in the bebop style, appearing in performances with pioneers Gillespie and Parker, "His jazz sounded superficially like what the swing players were doing, but somehow it had a tantalizingly different flavour. Both rhythmically and harmonically Christian was edging into something new" (Lincoln Collier, 1978, p. 343).

Gradually, more jazz guitarists of the time started to play and improvise in that style and so modified the way they approached their melodic lines to incorporate more arpeggios (thus delineating the chords), and chromatic runs, as well as more intricate rhythmic phrasing and intervallic experimentation, like the horn players would. A good example of this is almost any recording by one of the most influential jazz guitarists, Wes Montgomery, such as the famous 'Four on Six' (from the 1960 album *The Incredible Jazz Guitar of Wes Montgomery*, Riverside Records).

Likewise, they started trying to copy the tonal qualities of trumpets and saxophones by modifying the way they equalized their instruments-with less high frequencies, and more mid and bass frequencies in their amplifiers. This gave birth to a way of

approaching the guitar that can still be perceived today amongst most jazz guitarists. However, more than it being derived as a new guitar style originally, this new way of playing (and particularly improvising) the guitar was a way of adapting it to a style that was developed through other instruments, namely the saxophone, trumpet and piano.

From this point onwards, particularly in New York, several jazz guitarists would start emerging not only as soloists, but also as band leaders. Some of the most influential of these players between the 50s and 60s are Barney Kessell, Wes Montgomery, Grant Green, Kenny Burrell and Jim Hall.

### **A historical overview of the development of the jazz and classical guitar in the conservatoire**

It is important to be reminded that, as I work today in the fields of classical and jazz guitar as a teacher, researcher and performer, my output is inseparable from one important fact that has shaped my development. That is that I have been academically educated in music. That in itself provides a different kind of musical learning process to the one which the original jazz players had, who were almost all largely, if not completely, self taught. Interestingly however, as far as academic studies are concerned, the history of the classical guitar is not greatly different to that of the jazz guitar. The guitar in general does not have a long history as a conservatoire instrument, particularly when compared to many other instruments which are considered to be in the *classical* family.

#### *The classical guitar*

As described earlier in this historical section of the thesis, the classical guitar as we know it was still in its infancy during the first half of the 19<sup>th</sup> century (quite literally, even in the physical shape and dimensions of its construction), a time when classical music had already gone past Bach and Mozart, and most of the instruments used in its performance had already long-established methods and refined approaches to

their learning. In fact as late as the 1940's the study of classical guitar in some of the most highly regarded conservatoires in northern Europe was rare. Recalling his audition at the Royal Academy of Music in London in that decade, Julian Bream (2012) says he was told "we can't teach you the guitar here, but we can teach you the piano".

In fact, according to Charron (2014) the first classical guitar course in the UK was given in 1959 by John Williams. Indeed Liverpool-based guitarist John Harper, who I have interviewed as part of this research (his full interview available in the appendices section) mentions that, in the 1960s "There was nobody to teach me the classical guitar in Liverpool" (2014). We know, however, that there was a school of classical guitar in the Madrid Conservatoire at least as far back as the 1920s, which was later led by Regino Sainz de la Maza in the 1930s.

We also know that the constant influence of touring and resident Spanish classical guitarists in South America in the first half of the 20<sup>th</sup> century (including Segovia, de la Maza and Llobet, all of whom temporarily resided in that region at different times during that period) led to the creation of higher education institutions for the study of the instrument, with the *Escuela Guitarrística de Venezuela* being founded in 1932.

It is difficult to imagine such a struggle to find conservatoires where to learn the classical guitar today. In the city of Manchester the Royal Northern College of Music provides specialist education on the instrument, as well as several others in the country, including the Royal Academy of Music in London and the Royal Conservatoire of Scotland. As a result, the number of highly accomplished classical guitarists today is greater than ever, and the UK has certainly positioned itself as one of the countries with the highest level of education available for the study of the instrument, with recent players of global fame educated locally at these institutions, including Milos Karadaglic (educated at the Royal Academy of Music in London) and Craig Ogden (educated at the Royal Northern College of Music in Manchester). Likewise, some of the most highly regarded international performers, such as John Williams, David Russell and Julian Bream hold positions of visiting professors and consultants at the Royal Academy in London.

## *The Jazz Guitar*

The phenomenon seen on the classical guitar is somewhat similar to that which can be seen with jazz education as a whole, as far as its recent entrance into the academy. It is widely accepted that degree courses in jazz started emerging with significance between the late 1960s and early 1970s. “Until well into the 1970s, only a very few accredited programs in this country (United States) offered students jazz in any form, the vast majority of schools remaining staunchly dedicated to providing instruction in the Western Classical tradition” (Ake, 2002, p.114). However, the University of North Texas is credited with having offered the first degree in jazz in 1947. In Leeds, UK, the first European degree course based on the study of jazz was offered since 1965.

International jazz guitar star John Scofield mentioned during an interview (2014) that he was the product of the first generation of academically trained jazz musicians, having trained at Berkeley College of Music, in the United States, in the late 1960s-early 70s. Closely linked with these courses was the creation of the, now universal, jazz learning/playing tool – and further reviewed later in this thesis - *The Real Book* (a collection of transcriptions of the most well known jazz repertoire), which was actually created *by* students of the Berkeley College of Music during that institution’s first years providing jazz education, as a resource for their own study of jazz, since there wasn’t any equivalent resource available for the study of the genre already in existence at the time.

As with the classical guitar, the study of jazz and its application to the guitar is now available worldwide. Although institutions such as the Berkeley College of Music and the Leeds College of Music remain as some of the most highly regarded centres for the specialist study of this specific genre, conservatoires all around the world offer its study. For example, the October 2015 edition of the *Music Student Guide* by *Downbeat Magazine* (p. 72) listed a *selection* of 222 jazz programs on offer for prospective students, with 53 universities and conservatoires offering programs in the east area of the United States alone.



## **The Real and Fake Books and their historic role in creating a canon for jazz studies**

Regardless of whether the musician is a guitarist or any other kind of instrumentalist, if he or she has studied jazz seriously since the 1970s they will most probably have used the *Real Book* and different *Fake Books* as important tools for learning, practicing and performing music.

Previous to the 1970s, *Fake Books* were compilations of songs which provided musicians with the chord symbols as well as the lyrics to many of the most important songs in the jazz and American songbook repertoire. However, these books did not incorporate the melodic components of pieces, in order to avoid copyright issues. During that decade, a group of students from Berklee College of Music were responsible for transcribing and compiling a selection of the most well known jazz standards, this time incorporating their melodies and calling it the *Real Book*, in order to differentiate it from its predecessors.

At this time, the academic study of jazz in colleges was still very new, and the Berklee College of Music was indeed one of the first major institutions to offer it. In an article of *Esquire* magazine dedicated to the *Real Book*, author Mark Roman (1991), compiles information from different sources, including the Berklee music librarian of the time, John Voight. Roman explains that the material available for the study of jazz at the time was very limited, with no equivalent resources (which included melodies of songs) already on the market, and mentions that the first editions emerged around 1971.

The compilation became indeed very useful and popular amongst musicians, and for decades was widely used, whilst being illegal and unlicensed by copyright holders. Indeed the creators of the book were subsequently prosecuted by the government and the music industry, eventually resulting in “America’s first full-blown federal trial for criminal copyright infringement” (Kernfeld, 2006).

It wasn't until 2004 that the Hal Leonard Publishing Company issued an authorised copy. As project initiator, Jeff Schroedl explains "We went to all the publishers of the songs in the original book and they were thrilled to hear about our plans" he continues "They were not only happy to finally receive royalty income from sales of the publication, but were also eager to help us fix the errors in the old editions" (2004).

In recent years and decades, a larger number of legal compilations have emerged which follow the same ideology of the real book – providing chord symbols and single melodies to American songbook and jazz repertoire. Some of them, however, also incorporate lyrical content, which the *Real Book* doesn't, and often include a number of pieces outside of the original *Real Book* repertoire. Additionally some are also dedicated to specific popular music genres such as blues and rock, apart from jazz standards.

As a resource for jazz musicians, the *Real Book* and many of the recent *Fake Books*, continue to be an (now legal) essential aid for informal performances, learning of pieces, arranging and the practice of improvisation.

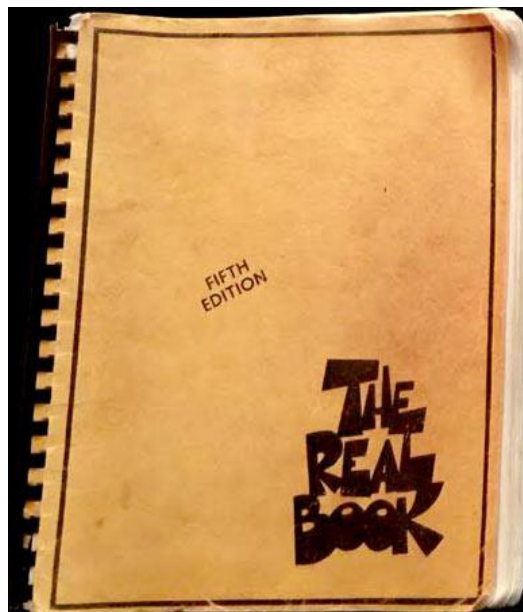

Illegal Real Book from 1980's (front cover) - Image 9

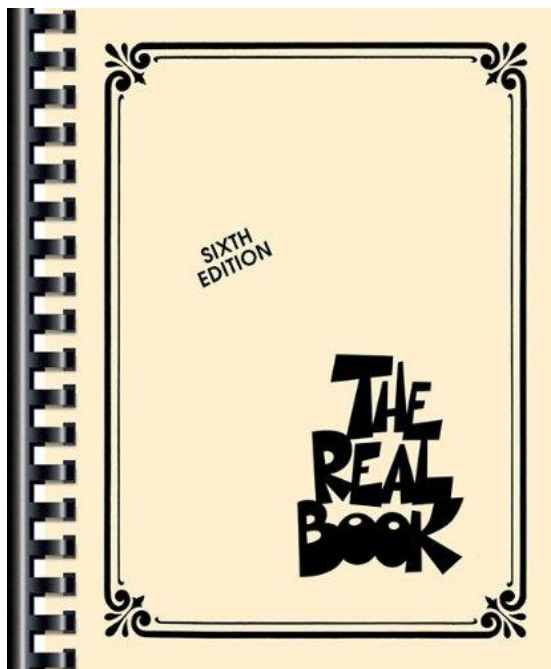

Legal Real Book from 2004 (front cover) – Image 10

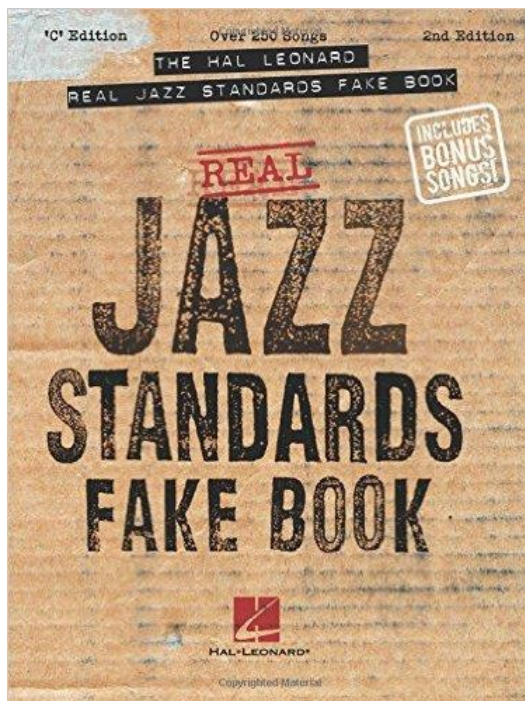

Example of a modern Fake Book of jazz standards – Image 11

## **An account of pedagogic theories and theories of embodiment**

The ways in which jazz and classical guitarists are trained are usually significantly different. Jazz guitarists, on the one hand, tend to absorb their knowledge through multiple routes, including a fair amount of self tuition, the use of multiple books, peer-to-peer learning, as well as tuition through lessons with (at times multiple) tutors and/or academic studies. However (and as demonstrated in the interviews conducted for this research) it is common to have highly skilled jazz guitarists who are completely self-taught. Classical guitarists, on the other hand, tend to arrive at their high level of playing through lessons; with self-tuition and the desire to absorb from different tutors/books being less common practice than in jazz. These are, however, generalisations which can be perceived in the interviews mentioned above. There are of course exceptions.

### *The process of embodiment and David Sudnow's Ways of the Hand.*

In his book *The Ways of the Hand – A Rewritten Account* (which is also further-reviewed in the *phenomenological analysis of the candidate's own experience* chapter of this thesis), David Sudnow explains his personal journey as a student of jazz. Differently to most musicians, and trained as a social anthropologist, Sudnow decided to start learning to play jazz piano as an adult (aged 30) and, as he learned, to document and analyse the process in order to identify its phenomenological characteristics. He argues that after having learned something, looking back and trying to remember/understand events that happened years ago in an attempt to understand the process is a much less effective way than documenting it as you go.

Referring to the learning of language (and he argues the same applies to the language of music) foreword provider to the book, Hubert L. Dreyfus says “By the time we are able to reflect, we are already living in our language and, as linguistic

beings we are in a poor position to offer a phenomenology of how speaking works” (2001, xiii).

Like most jazz players, Sudnow embarks on a combination of methods of learning, which change as he develops. Amongst these are lessons with jazz pianists, intense listening and trying to emulate the sound on records, as well as self-experimentation with the instrument and peer-to-peer consultations and exchanging of ideas. Through doing this, he identified that eventually, after slowly achieving chord sounds through the application of theoretical information (for example: looking for the root, third, fifth and seventh of the scale), the player starts to see selections of notes visually as a whole “As my hands began to form constellations, the scope of my looking correspondingly grasped the chord as a whole, seeing not its note-for-noteness but its configuration against the broader visual field of the terrain” (p. 13).

Good jazz players most frequently refer to good improvisation/playing as that which is not just made of notes which correspond to the key and specific harmony, but which is directly connected to the musician’s ears, in other words *playing what you hear*. Sudnow describes what is a long period of working on principles before the ears begin to connect with the hands “it wasn’t until the start of my third year of playing that I thought of myself as going for the sounds” he continues “There wasn’t one me listening and another one playing along paths” (p. 40).

This could be particularly important from a pedagogic perspective. If a student begins to learn an instrument and has no concept of when he will arrive at such stage (or any particular stage) of development, it could lead to a much more confusing and frustrating process, potentially affecting the outcome or even causing a desire to stop learning. In other words, the way a student feels about the potential outcome of a particular amount of work or effort will affect the process significantly. As Irons (2008) says “The effort that students make toward achieving goals is affected by how they feel about those goals and how they perceive the likelihood of achieving those goals” (p. 36).

Sudnow also makes clear that, even though he could see and hear this process of connecting ears and hands beginning during his third year of studying, it was a very slow and gradual phenomenon, which would take a great amount of further work and perseverance in order to be mastered completely “If the note beneath the thumb is played (on a particular chord shape), I might know what the one beneath the first finger will sound like” (p. 59). At this stage Sudnow is, in other words, starting to recognise intervals by ear, and associating them to the way his hand looks on the instrument.

It is clear, through Sudnow’s account, that the relationship between the hand and the ears is one where they both influence one another “In doing competent jazz improvisation now, I never project sung sounds independent of how my hand finds itself situated” (p. 68). This is interesting, given the generally perceived idea that the connection works only from the ears to the hand and not the other way around.

#### *Implications to Peer-to-peer learning and jazz/popular music education*

For most popular and jazz musicians (and as can be seen in the previously explained case of David Sudnow) learning from other players in non-lesson environments is an integral part of the process of advancing in their field. It is interesting to see that today, in a time when jazz and popular music studies are formally established within the academy, this aspect of learning in these disciplines perhaps hasn’t yet been embraced to the fullest within academic training strategies.

In her book *How Popular Musicians Learn – A Way Ahead for Music Education* (2001), Lucy Green says that “detailed investigations by popular music researchers into the specific *nature* of popular music learning practices or their relationship to formal music education has been relatively minimal” (p. 6).

Referring to learning among peers, Green later mentions that peer learning “can arise in casual encounters or organised sessions; it can occur separately from music making activities or during rehearsals and jam sessions. The different settings in which such learning takes place are liable to flow into each other. For example, a member of one band can show a new lick or chord to a member or several members

of another band; a player may learn something by watching or listening to another player, who remains unaware of the fact that any learning is taking place; members of a band are likely to have casual learning encounters outside their rehearsals, the results of which are then consciously or unconsciously brought back into the rehearsals” (p. 77)

### *Multifaceted approach to learning and receiving tuition*

It is possible to relate the multifaceted approach which Sudnow had to successful jazz learning, as well as that which many of the jazz guitarists interviewed for this thesis (and myself) had, with Green’s suggestion that peer learning should have a more important role in academic education within popular styles. In this respect, academically speaking, a question could be raised as to the positive effect that cultivating more of these kinds of interactive scenarios could have on guitarists within these branches of music.

Jazz guitar star John Scofield (regarded as one of the most influential guitarists in jazz since the 1970s) teaches a part-time jazz guitar module at New York University. He also supports the ideas of each learner being an individual case and learning from different sources “I believe that we all learn from each other. There’s a lot of teaching that is overly theoretical and not really good, I don’t have a method for teaching at all” (2013). It would be interesting to explore the possible results of an environment created in order for these interactions to routinely happen between guitarists in the jazz and classical styles, as part of curriculum.

Nonetheless, when further-explaining his approach to delivering his module, Scofield mentions an interesting, yet not necessarily widely known approach “I make a little ensemble with a bunch of guitar players and I make everybody write a piece for five guitars once per semester, and we all jam on it” (idem). This suggests that for an individual such as Scofield, with immense experience in the style of jazz, enabling a peer-to-peer learning environment is an important element (if not vital) to the process of mastering the style.

Laura Ritchie, from Chichester University, argues that the idea of receiving instrumental instruction from various different teachers and sources would be a way of bringing the multifaceted approach that non-academic students of popular and jazz music originally had. "Each musician will have experience with their own teacher, but a single source is a very narrow view, and does not allow for a well-rounded pedagogic practice" (2016, p. 3).

The psychologist and researcher Howard Gardner coined the term *Multiple Intelligences* or *M.I.* He argued that intelligence itself is a multifaceted concept, as Booth (2009) explains "M.I. theory proposes that intelligence is more than a binary quality you either have or don't have; it is more than the math and language skills the SAT test addresses; it identifies at least eight distinct kinds of intelligence, each of which every individual has to a greater or lesser extent in his or hers personal mix" (p. 55).

However, Gardner also did work into the specific subject of learning in the arts, noting that the multifaceted concept was crucial to complete training, as Booth explains "Before Gardner gained fame for his M.I. theory, he wrote about artistic learning, dividing it into four essential roles within which every student should have experiences and develop skills, in whatever discipline the student is engaged. He feels that each of these roles is distinct and complimentary, and that fully rounded learning includes a series of activities that challenge students in all four roles to develop the abilities inherent in each: creator, performer, audience and critic" (idem. P. 55)

There is agreement amongst different sources that this mutual learning between students as part of the formal design of teaching environments and classes is significantly positive and relates to the natural process of effective learning "Exchange of ideas and skills amongst participants becomes an integral part of the process, thus deepening one's understanding of, and connection with, music" (Burnard, 2013. P. 56)



### *The future of teaching in the fields of music and the guitar*

The above ideas demonstrate that the world of pedagogy in music is one which keeps evolving continuously. As with education on a grand scale, there is a desire to refine not just the quality of the information and content offered through teaching, but the ways in which the delivery of that information is approached in order to make learning a more overall stimulating and inspiring endeavour; embracing the idea of creating (or re-creating) the environments in which learning happens naturally.

In this regard, particularly within institutions or scenarios where the content of teaching is pre-established (such as colleges, conservatoires, universities, schools or grade exam preparation) the acknowledgement of the *individual*, and his/her unique way of processing and filtering information, is being taken into account in order to improve the effectiveness of teaching.

In the book *The Art of Teaching Music*, Estelle Jorgensen argues that for a long time music education has been tied to the ways of the industrial view of the world (where the exact same procedure is applied indefinitely in order to obtain the same – assumingly good- result again and again), and that this is a shortcoming within teaching environments.

“In the post-industrial world, these old notions of standardization need not apply. Now other models and metaphors suggest an array of very different options. It is possible to cultivate specialisations and divergences rather than standardised *products*, enable a person-centred rather than subject-centred focus, and foster individualized individualised as well as large-group instruction by means beyond face-to-face situations” (Jorgensen, 2008. P. 202).

As a guitar teacher with experience of providing instruction for over ten years at all stages (from complete beginner to university level) I have learned that, in all cases, trying to learn about the student’s personality, taking an interest in them as individuals, and tuning into the *different* ways in which they each tend to succeed at grasping and mastering new concepts is an immensely valuable tool. It not only helps to reassure the student that we are as enthusiastic about being there as they are, but

also (and partly as a consequence) helps to create an environment where the effective transmission of knowledge is much more likely.

### **An examination of influential players and their technique**

In this section, a selection from the most key influential players in the jazz and classical styles will be analyzed in order to provide a view of the diversity and individuality that exists amongst performers in each genre, whilst also providing clear examples of the ideologies that define each school of playing. This will also make evident the fact that there are bigger differences amongst the technical approaches of different jazz players, given that self-tuition is much more common in that genre.

Specific recordings will be suggested as ideal examples of each player's distinct musical personality, whilst a full discography of recordings which have been consulted during the research (and others which are significant and relevant to the subject) will be provided at the end of the thesis.

An effort is made to give an accurate and all-encompassing view of the two guitar worlds. The reader may notice, however, that as far as classical repertoire is concerned, the guitar music of Spain and Latin America will be at the centre of the discussion, more so than other branches. This is because it was predominantly (but not exclusively) music and individuals from these regions that were responsible for the development of the classical guitar as a serious and academic instrument during the late 19<sup>th</sup> and early 20<sup>th</sup> century (namely Segovia, Tarrega, Albeniz, Sainz de la Maza, Villa Lobos, Barrios and Rodrigo, amongst many others).

Likewise, within the jazz idiom, music derived from (and influenced by) the bebop era will also be at the centre of the discussion. This is because this genre is widely considered to have taken jazz to a more advanced and intellectual level than it enjoyed previously during the swing (and earlier) eras. From the bebop period and beyond, a competent jazz musician needed to have a deeper and more advanced understanding of harmony, composition and theory, in order to be able to improvise

over more advanced harmonic progressions and with a more refined and progressive concept of melodic creation, development, and tension and release. These developments played a major part in pushing jazz towards becoming a style that was later to be studied within academic environments.

### ***Classical guitarists***

#### **Miguel Llobet (1878-1938)**

There were a small number of guitarists who played a vital role in passing on the technical advances made by the most distinguished guitarists of the 19<sup>th</sup> century to young players who would be at the forefront of classical guitar in the first half of the 20<sup>th</sup> century. Amongst them was Miguel Llobet, who was born in Barcelona on 18 October 1878. “He was instrumental in establishing the classical guitar on the international concert scene” (Cummings, 2017).

Having been taught in Barcelona by Francisco Tarrega himself (who is widely regarded to have been the most influential figure in developing the modern technique for the classical guitar), Llobet developed into an international performer, touring all over Europe, as well as South, Central and North America during the early years of the 20<sup>th</sup> century. His career also saw him become professor of guitar at the Conservatory of Malaga and mentor several of the most celebrated performers of the history of the instrument, including Andres Segovia. “Llobet pioneered the way for guitarists in succeeding generations, not least of whom was Andres Segovia, an admirer of Llobet’s virtuosity, as well as of his compositional skills” (idem).

Llobet’s output, however, was as significant in the area of repertoire as it was in the area of performance, as he was responsible for arranging a series of traditional Spanish and Catalan folk songs for the classical guitar (notably El Noi de La Mare, El Testament d’ Amelia and El Mestre, amongst many others) as well as classical pieces originally written for other instruments, famously those of Mendelssohn and Albeniz (whom he knew personally).

Additionally he also composed his original material, although his humility perhaps did not encourage him to try to make them well known “Despite his exceptional ability as a guitarist, Llobet was by all accounts notable for his modesty, and indeed he did not record any of his own compositions for guitar” (Spencer, 1980). A good example of this is *Study in E Major* which can be heard performed by Lorenzo Micheli on the album *Miguel Llobet Guitar Music*, released by Naxos in 2004. The album *Miguel Llobet – Classical Guitar masters of the 1920s*, on the other hand, provides a compilation of recordings made by Llobet himself. In them we can perceive a high level of technique, with a special emphasis and attention to the handling of time for dramatic and expressive effect, as it was common in the Romantic guitar school in which he developed.



Andres Segovia (third from the left), and others, attentively witnessing Miguel Llobet's playing. Image 12

### **Agustin Barrios Mangore (1885-1944)**

Born in San Juan Bautista de Las Misiones, Paraguay in 1885, Barrios is highly regarded still today regarded as one of the most important individuals in the history of the instrument – “The best guitar composer, as in – guitarist who wrote for the guitar, of all” (John Williams, 1993).

His compositions vary from Romantic and Baroque-influenced pieces to Latin American folk-influenced classical music. Of them, the piece *La Cathedral* (a three movement concert piece) is frequently regarded as the most outstanding, and is widely popular amongst concert classical guitarists. Of his folk-influenced compositions, *La Ultima Cancion* and *Sueno en La Floresta* are perfect examples of his merging of classical and folk influences.

For his time, Barrios was not only an accomplished performer, but certainly virtuosic. “In 1934 he went to Europe to perform, becoming the first Latin-American guitarist of stature to do so” (Vaught, 2017). The demands presented by his compositions are still challenging today for highly educated conservatory guitarists. Of these, his own flawless performances can still be heard on the compilation recording *Agustin Barrios, The Complete Guitar Recordings 1913-1942*, released in 2001 by Mel Bay publications. On these performances one can not only hear clean and accurate interpretation, but at times even further virtuosic elements (beyond those demanded by the pieces) such as further rapid *accelerando* and an outstanding use of dynamics and expressive devices. A perfect example is the performance of *Waltz N3* included within these recordings.

### **Emilio Pujol (1886-1980)**

Emilio Pujol was born on 10 September 1886. He was of the same generation of key influential guitarists as Miguel Llobet and, like him, received personal tuition from Francisco Tarrega. This ensured that the young guitarist was equipped with the cutting edge of classical technique of the early 20<sup>th</sup> century. As taught by his mentor, and certainly was the vision of the romantic approach to the guitar, he thought that “The voice of the guitar needs to be something between the human and the divine” (Pujol, n.d.).

His career saw him involved in areas of performance, composition, as well as teaching. As discussed in other parts of this thesis, he was responsible for possibly

the most significant method for the guitar designed around the technical teachings of Tarrega – *A Theoretical, Practical Method for the Guitar, based on the principles of Francisco Tarrega*. Additionally he also composed pieces dedicated to him and is the author of *The Biography of Francisco Tarrega*, making him one of the main individuals responsible for disseminating all information available about the life and work of his mentor. “Pujol, musical inheritor of Tarrega, took the teachings of his master as far as he possibly could” (Franco, 1980).

As with others from his generation, as well as through his received tuition, Pujol was technically rooted in the school of Tarrega and the romantic approach to the classical guitar. Interestingly, and the cause of a publicly known disagreement with Segovia, Pujol made widely known his opinion that “the most expressive tone on the guitar is achieved by the fingertips, and not by any use of the nails” (Wade, 2001. P.115). Although his recordings are few and not easy to find, his playing can most easily be found on the recording *Spanish Songs – A Historical Live Recording of the 1954 Madrid Recital*, in which he is presented as a duo with soprano Rosa Barbany. This album/concert was mostly dedicated to Spanish music of the 14<sup>th</sup> through to 16<sup>th</sup> century, and includes music still popular today in the instrument’s repertoire by the likes of Alonzo Mudarra, Gaspar Sanz, Luis de Narvaes and Luis Milan. Nonetheless, there are also five pieces at the end of the recording of popular nature. Notably, one can hear Pujol’s use of the *rasgueado* technique (popular in flamenco, and not always seen as orthodox at the time for the classical guitar) on the piece *Farruca*.

### **Andres Segovia (1893-1987)**

Largely regarded as the most influential classical guitarist of the 20<sup>th</sup> century, Andres Segovia had probably the most important role in taking the instrument from an item of interest amongst minorities in Europe to the most important classical concert stages around the world. “To say that every serious classical guitarist today has been profoundly influenced by Segovia is no exaggeration” (Lorimer, 1992).

Born in Linares, Spain, in 1893, Segovia was a self taught guitarist who started by listening to the local flamenco of his region, Andalucía, and asking local players to teach them what they knew. He developed an passion for the instrument which was coupled with a realization that its classical practice (although had made significant advancements during the previous 50 years – especially through the work of Tarrega) hadn't been disseminated to the extent that it deserved, and its repertoire remained rather limited. Upon being encouraged to change instruments to the violin by a professor from the Madrid Conservatoire who saw him play and, noticing his talent, told him that he had a better chance of making a career out of the more established and traditional instrument, the young Segovia said "I would never turn my back on the guitar. It needs me, the violin doesn't. I have also sworn to walk in the steps of Francisco Tarrega, who lived and died for his beloved instrument, with little hope of glory or gain" (Segovia, 1977, p.52)

Touring all over Europe, South and North America, as well as throughout the rest of the world, commissioning works and transcribing music for the instrument, Segovia's output was unequaled in his lifetime. Apart from this, he was responsible for teaching many of the most celebrated guitarists of following generations, including John Williams, Alirio Diaz, Christopher Parkening and Michael Lorimer, among others.

In his technical approach to playing, Segovia was always one for prioritizing the feeling and expression above all. Although his efficiency and the logic of his fingering choices, posture and execution (for both the left and right hands) were of the highest order, he never allowed these considerations to get in the way of his main goal. "For the most part, he leaves technical matters to one side, never approaching technique as an issue in itself but always relating it deeply to music" (Lorimer, 1992).

Segovia's numerous recordings offer a real insight into his work. However, critical to an understanding of his output as a performer is an awareness of his interpretation of Spanish music, and of works by master composers transcribed by him for the guitar, most importantly those of J. S. Bach. The album *The Art of Segovia*, released in 2002 in its re-mastered version by Gramophone, provides an excellent window into his

work, with many pieces within the above-mentioned categories. Of those, the composition *Asturias (Leyenda)* by Isaac Albeniz (originally written for the piano but transcribed for the guitar by different guitarists – Segovia’s version being the most well known) is perhaps the most universal of classical Spanish pieces, and Segovia’s use of the guitar’s resources in order to convey the feeling of his homeland’s art and culture is unique. *Prelude from Cello Suite N 1* is a perfect and beautiful example of his transcriptions of Bach.

### **Regino Sainz de la Maza (1896-1981)**

Sainz de la Maza was born in Burgos, Spain, y September 1896. His most well-known achievement was probably that of playing the guitar at the premier of the most famous guitar concerto of all, the *Concierto de Aranjuez*, in 1940, which was also dedicated to him by composer Joaquin Rodrigo. “His close friendship with Falla, Rodrigo, Lorca and Dali, established his centrality in the Spanish culture of this era” (Wade, 2001).

Studying with Tarrega’s disciple Daniel Fortea, and developing as a guitarist amongst the likes of Andres Segovia and Miguel Llobet in Barcelona during the 1910s, his technique and approach to the instrument was at the forefront of classical guitar in the early 20<sup>th</sup> century, and he was indeed named professor of guitar at the Conservatory of Madrid during the 1930s. His technique is characteristic, and a perfect example, of the technique that evolved from the early 20<sup>th</sup> century onwards and as a consequence of the Tarrega school of the late 19<sup>th</sup> century. This technique is highly concerned with tone refinement as well as with the use of the different tone colours possible on the instrument for dramatic effect through different angles of plucking, various combinations of skin and nail contact during strokes and the use of plucking over different parts of the guitar body. Although his influence and status is undeniable amongst the classical guitar world, de la Maza was perhaps not as celebrated during his own time as he deserved, perhaps due to the fact that he lived in the same era as the emerging Andres Segovia “His reputation as composer,



teacher and editor has been steadily enhanced over the years since his death” (Wade, 2001).

His refined and supreme sound can be heard during the first known recording of the *Concierto de Aranjuez* from 1949, with the National Orchestra of Spain, which was published by the Chanterelle Label.

### **Alirio Diaz (1923-2016)**

Born in Carora, Venezuela, Alirio Diaz became one of the most well known classical guitarists of the 20<sup>th</sup> century, first studying in Venezuela under the guidance of the man responsible for creating the classical guitar tradition of that country, Raul Borges, who had been himself a student of a disciple of Francisco Tarrega.

Diaz, then went to Spain with a government scholarship “He completed his studies with Regino Sainz de la Maza in Madrid, following Borges’s death” (Harris, 2017). After finishing his training at the conservatoire of Madrid, Diaz then studied with Andres Segovia for several years. Ultimately, his ability on the instrument, and Segovia’s trust, resulted in Diaz being asked to run Segovia’s teaching commitments in Siena (where he had setup a teaching practice with a selected number of pupils) for different periods when Segovia was not able to attend.

One of the characteristics of Diaz’s technique and approach to the instrument is that he was one of the first classical guitarists of the generations after Segovia to incorporate less romantic expressionism to his performances on the instrument. Far from removing a consideration for rubato altogether, Diaz was certainly different in that sense from the guitarist of the previous generation “Though he had studied with Segovia, Diaz’s clean, well articulated playing, free from rhythmic exaggeration, was very much in line with contemporary concepts of interpreting music” (Wade, 2001. P. 152).

Diaz's life work is also inseparable to the work of classical guitar composer Antonio Lauro, as he was pivotal in ensuring that the composer's work was played on the most highly respected classical music halls worldwide during his celebrated performing career. Diaz's admirable clean sound, and articulation was (although perhaps this took away from the delicacy of the sound) perhaps partly due to his use of slightly longer nails than most players. This coupled with the flexibility of his thin, elongated fingers made him able to approach the instrument with particular facility. His excellence in the performance of music from Albeniz and Lauro to Bach is well documented on the album (perhaps inappropriately called) *Five Centuries of Spanish Guitar Music*, released in 1994 by Essential Media.

### **Ida Presti (1924-1967)**

French guitarist Ida Presti (born in Suresnes, France in 1924) is by many considered one of the most virtuosic classical players in history. "At the end of the war, interest was focused on Ida Presti" (Wade, 2001, P. 134) Her work was particularly important for the purpose of understanding the mechanics of how the strings and fingers behave when plucking, and the effect that this has on the tone produced by the instrument, as well as in the efficiency of technique. The basic principles of this are not well published, and only taught through Presti's own students, who pass it on through their own teaching. Alice Artzt is one of best known pupils of Presti, and her video tutorial *The Ida Presti Right Hand Technique for Guitar* (2001) explains it in detail.

The basics of this technique are oriented towards the realization that the more the strings can vibrate perpendicularly to the guitar surface, the more powerful and rich the sound will be. This is because in this way, the string will (through the bridge) stimulate the soundboard to vibrate up and down with it, in a way that wouldn't be possible if the string vibrates predominantly sideways. This in turn will result in a much more significant transmission of the string's frequencies through to the air, hence resulting in a much richer and louder sound. "Her perfect sense of rhythm

showed to best advantage in the Spanish pieces, while her wide range of tone colours gave a beauty hitherto unknown to familiar pieces” (Wade. 2001, p. 135).

Towards the second half of her career, Presti contributed significantly to the creation and performance of duo music for the guitar. She and her husband, distinguished fellow classical guitarist Alexandre Lagoya, commissioned new duo music from some of the most respected composers for the instrument, including Castelnuovo Tedesco and Rodrigo (who also wrote a piece dedicated to Presti on her sudden death from a lung tumor in 1967, at the age of 42).

Presti’s technique and performance style can be best perceived in a compilation of recordings named *The Art of Ida Presti* and released most recently by the label Idis in 2013. The repertoire is mostly composed of Hispanic music from the 19<sup>th</sup> and 20<sup>th</sup> century, whilst also including compositions by Bach and Paganini, amongst others. Her technique is not only incredibly efficient but, like most of her contemporaries, heavily rooted in the Romantic approach to expression and dramatic devices. Notably, Presti’s intense and rapid use of vibrato can certainly be considered as one of her signature sounds.

### **Julian Bream (1933)**

During the 1950s, when asked who he thought would be at the forefront of classical guitar in years to come, Regino Sainz de la Maza (n.d.) replied with two names, that of John Williams and that of Julian Bream.

Julian Bream was born in 1933 in London. He developed as a musician in an environment which was unusual for most classical guitarists, as he grew up around jazz music, particularly that of guitarist Django Reinhardt, who was his inspiration for picking up the instrument. Soon after starting, his father brought home a recording of Andres Segovia playing the music of Francisco Tarrega, which caused Julian to gravitate towards the classical guitar, and he quickly started teaching himself through the methods and compositions of the likes of Fernando Sor and Dionisio Aguado.

Bream became one of the most influential guitarists of the 20<sup>th</sup> century, recording extensively, touring worldwide, and motivating major composers to write for the guitar (famously Benjamin Britten). Further to this, he was also pivotal in the revival of interest in the lute during the 20<sup>th</sup> century, of which he was himself a virtuoso performer, both in a solo and ensemble context. “By the late 1950s, Bream had established himself as a professional lutenist and guitarist, readily able to commission new pieces from composers” (Jeffries, 2013).

As far as Bream’s approach to the instrument is concerned, he is frequently considered to be one of the performers with the greatest sense of artistry and musicality. This is partly as a consequence of his use and combination of tone variations, and intelligence in the manipulation of time and dynamics. It is this rather than flawless technical accuracy that Bream is mostly celebrated for (although his technique is without a doubt one difficult to surpass by most). John Williams, on the other hand, was (though not exclusively) more often associated with flawless technical perfection and a desire to stay close to the interpretative approach associated with the time period in which the composition was conceived. Bream’s deep sense of musicality is something that indeed never stopped consciously evolving. “I am a better musician now than I was at 70” says Bream (2013) aged 80.

Although Bream’s artistic output has been incredibly diverse (playing anything from Spanish, Baroque, Romantic, Classical, Renaissance, Latin American, Contemporary Classical to even Indian Music), his sensibility and musicality can be perceived significantly in his recording as an adult of what he himself says was the first full classical piece he learned – Fernando Sor’s *Study in B minor*. It can be heard in its re-mastered version on the album *Spanish Guitar Music*, released in 2001 by Westminster Legacy.

## **John Williams (1941)**

“In 1952, Segovia came to London and John Williams played for him at his hotel. Probably the most important performance of his life. With Segovia, a most difficult man to impress, reaction was immediate...” (Wade, 2001, p. 147). Segovia asked him to attend his (very exclusive) summer guitar school in Siena that summer.

In the opinion of many, there are two figures that have been most influential on the classical guitar stage since Andres Segovia. They are Julian Bream and John Williams. Williams was born in Melbourne, Australia, and moved to London at the age of 11. His father was a guitarist with a background in jazz, who taught him the instrument at the early stages. Nonetheless, he was very enthusiastic about the classical guitar and considered it to be of unique beauty and artistry, which led him to found the London Guitar School. Williams is indeed largely responsible for promoting the classical guitar in the UK, having created the first academic classical guitar department in the country in 1959 at the Royal College of Music in London.

Apart from this, John Williams is one of the few major classical guitarists who has taken the classical guitar and experimented with musicians from other styles, famously doing tours as a duo with jazz guitarist John Etheridge, for example, or participating with the band Sky. In this sense, Williams certainly breaks the perceived image of the classical musician who prefers to remain within the realms of their style due to a belief that it exists in a superior category. “Williams is regarded as one of the foremost musicians of his generation, a master of the classical repertoire who brought the guitar to a wider audience with the group sky and through collaborations involving the music of South America, Africa and jazz” (Alberge, 2012).

Stylistically in performance, John Williams’ technique and approach are very much concerned with being sensitive and attentive to the aesthetic preferences in use at the time when compositions were conceived. The guitarists that descended from the Tarrega school, including the likes of Pujol, Segovia, Llobet and de la Maza, all had in their playing an unmistakable sense expression associated with, and derived from the romantic period. This was often heard even in repertoire from previous

centuries. Williams contributed in a major way to establishing an approach with a close connection to the era of the music and less dramatic enhancement through the extensive use of rubato. This, coupled with his extraordinary technique is, for some, considered have resulted in a lack of expressiveness in some of the romantic repertoire.

Three pieces from contrasting periods that demonstrate his accuracy in each stylistic approach, as well as formidable technique, are *Canarios* by Gaspar Sanz (1640-1710), *Asturias Op. 47/No 5* by Isaac Albeniz (1860-1909) and *El Marabino* by Antonio Lauro (1917-1986). All of these pieces can be found on the album *John Williams – The Guitarist*, released by Sony Music Classical in 2011.

### **David Russell (1953)**

Scottish born classical guitarist David Russell lived in Spain since the age of five. Taking an early interest in the guitar, he later studied at the Royal Academy of Music in London, winning a series of international competitions for the instrument, such as the Julian Bream Guitar Prize and the Andres Segovia Competition.

Utilizing all the principles of established classical technique, Russell is known for his flawless ability at all levels of complexity, but also for his musicality and sense of expression. In this sense, he possesses a richness and refinement of tone unequalled by most, which allows slow and gentle passages to be particularly beautiful. In general, and though his technique is of the highest order, his view is one of musicality and beauty above technical prowess “You do a concert so that the audience enjoys what you are doing. Not to show them who you are” (Russell, 2015).

As far as his approach to playing, Russell is known for his diverse repertoire, which includes pieces from all periods, from early music to contemporary classical and South American compositions. One interesting aspect of his approach to learning and memorizing compositions is that Russell learns pieces backwards “I memorize the last bar. Then I learn the penultimate bar, etc. (This way) when you learn the

penultimate bar, you know where you are going. If you learn from the top, you learn the first bar and you are always going into no-man's land. For me that puts things in the correct order" (Russell, 2015).

For anyone interested in Russell's musical output, it is important to ensure that the diversity of his repertoire is considered. Suggested recordings in order to gain a sense of this diversity are *David Russell Plays Baroque Music* (2008, Telarc) and the Grammy award-winning *Aire Latino* (2004, Telarc), which give a good perspective of his interpretation of music from three centuries apart.

## ***Jazz Guitarists***

### **John McLaughlin (1942)**

To many considered the most significant pioneer of jazz fusion on the guitar, John McLaughlin was there since the beginning, playing alongside one of the most influential musicians in jazz, Miles Davis, as the jazz sub-genre was conceived. Born in Yorkshire, England, he first studied the piano at an early age before switching to the guitar. Going from blues to jazz, he eventually moved to London and became one of the most respected guitarists in the city's jazz music scene.

He released his first solo album (*Extrapolation*) in 1969 "a virtual summary of small group playing techniques of the time, a catalyst of the jazz-rock movement of the 1970s and one that proved McLaughlin to be both a fine composer and a sublimely original guitar stylist" (Carr, 2004). Eventually moving to New York, McLaughlin became involved with former Miles Davis quintet drummer Tony Williams's band *Lifetime*, later joining Davis himself as a part of his live and recording team for a number of years. From this point onwards he was established as one of the leading guitarists in jazz, with his sound and fusion style massively influencing the next generation of players on the instrument.

McLaughlin's technique is identified by the use of alternate picking at fast tempos. In this regard, he chooses to hold the plectrum between his thumb and index finger, in the way that is preferred by many electric guitarists – by placing it where the joint dents are, in order to reduce slipping and increase grip and control with less necessity for strength and energy expense. Speed and prolonged passages at fast tempos are indeed one of the key features of his style, which also incorporates interesting and intricate rhythmic/motivic development, informed by his experiments with Indian music and culture, as well as his collaborations with some of the finest practitioners in that musical tradition (such as Zakir Hussain and Lakshmilayana Shankar).

Interestingly, and differently to many jazz players, his left hand fingers approach the strings at an angle which is approximately 45 degrees from the strings and fretboard. In this aspect, McLaughlin approaches the instrument more similarly to many rock guitarists. Jazz guitarists on the other hand, tend to (though not always do) align their left hand fingers in a way that is closer to being perpendicular to the strings and neck. This usually provides more equal access to the strings by all fingers (as opposed to some having to stretch more in order to reach), and allows the fingers to more easily approach strings from directly above (using their full strength) rather than from the side. Nonetheless, McLaughlin's technique is frequently referred to as one of the best in jazz.

“He is a visionary, and a true artist, constantly searching and growing, who describes himself as *a musician for people who are not musicians*. Like Miles Davis, Keith Jarrett and Weather Report, he has gained both a huge public following and the admiration of his peers” (Carr, 2004).

The number of projects and artists that McLaughlin has been involved with is enormous. From Miles Davis, to Jaco Pastorius, to Chick Corea, to Carlos Santana, to the Rolling Stones he has been session musician, side man, band member and solo artist. To get a broad idea of his personal style and vision in music and guitar playing, three essential recordings are recommended. The first one is the Miles Davis album *In a Silent Way* (1969, Columbia). This album is widely considered to be one



of the main signs that indicated the arrival of jazz fusion (jazz with elements of rock and popular music) onto the mainstream jazz scene. It also indicates McLaughlin's debut recording with Davis. The opening guitar line is one of the guitarist's most memorable passages and gives insight into his musicality and taste, which are sometimes overshadowed by the popularity of his fantastic technical prowess.

The debut album by the Mahavishnu Orchestra – *The Inner Mounting Flame* (1971, Columbia) was McLaughlin's first effort after the end of his participation in Miles Davis's band. It cemented his reputation not only as a leading jazz guitar player, but as a band leader and composer. Finally, the first and self-titled album by the band Shakti (1975, Columbia), explored the fusion of contemporary jazz improvisation with Indian music and improvisation ; and showed McLaughlin's skills on the acoustic guitar.

### **Pat Martino (1944)**

Pat Martino is probably one of the most influential guitarists in the jazz genre to emerge in the 1960's and still be active today. Born in New Jersey, USA, Martino shared the New York jazz guitar scene in the 60s with the likes of Grant Green, Kenny Burrell, George Benson and West Montgomery, as well as knowing them personally. At a young age he met West Montgomery at jazz clubs where his father would take him to hear him play, and through conversations with him, as well as through learning his music, Martino started to develop his style.

Amongst jazz musicians of his generation he is regarded to have one of the best techniques on the instrument. "He is scary, he is the original shredder" (Ritenour, 2010). His use of the plectrum is impeccable, and he utilises a preferred technique amongst many of holding it between the inner part of the thumb-exactly where the joint is located, and the left side of the index finger (that which is closest to the thumb) also at the joint. With this approach his definition and articulation are of the highest order. George Benson says "I walked into (the club) Small's Paradise and saw this young kid on the guitar. I was thinking *oh what is he going to do? I should*

*get up there and show him how to play.* All of a sudden they came to a break in the music and this guitar just leaped out of nowhere, playing some of the most incredible lines I had ever heard. It had everything in it; great tone, great articulation, and the whole audience, a black audience, went crazy” (2007).

Additionally, Martino’s understanding of, and approach to, advanced harmony are both advanced and unconventional. As can be seen in the literature review section of this thesis, where his approach is described through a review of his book *Linear Expressions*, he tends to use deep original reasoning in order to eventually simplify harmonic understanding as well as find routes to its contemporary and unconventional use. Well known jazz bassist Christian McBride says of his experience playing with Martino “Many musicians you play with are very concerned with things such as ‘make sure you get that change’ you go beyond that” (2009).

Essential to an understanding of his journey as a musician is the knowledge that Martino had a brain aneurism which nearly ended his life at a point when he was already established as one of the most exciting guitarists in jazz. Years later Martino re-learned the guitar after having almost completely lost his ability to play the instrument. Martino’s playing has been largely focused on the standard repertoire of jazz, as well as in the area of fusion, jazz/soul and jazz/funk. Two recordings are pivotal in his career. The first one, recorded before his brain aneurysm, is *El Hombre* (Prestige, 1967), which is a perfect showcase of his fluidity at high tempos as well as harmonic prowess. *Live at Yoshi’s*, was recorded in 2001 and released on Blue Note records, and perfectly demonstrates his outstanding work re-learning the instrument and interacting in a live setting with legendary organist Joey DeFrancesco and drummer Billy Hart.

### **Robert Fripp (1946)**

Some individuals have affected the technique of the electric guitar in particularly significant and influential ways, doing a great amount of personal research and experimentation in order to bring physical logic to the approach to an instrument

which, comparatively to most (and despite its great popularity), is still in its infancy. Robert Fripp is one of those individuals.

“For me art is the capacity to re-experience one’s innocence. Craft is how you get to that point. Maturity in a musician would be the point at which one is innocent at will. At that point the relationship between music and the musician is direct and reliable” (Fripp, n.d.)

Although he was taught at an early age by Don Strike, Fripp soon after began to teach himself at the more advanced stages of his development. Through this process he developed different aspects of technique to incredible levels of efficiency, such as crosspicking (playing three consecutive notes on adjacent strings and finding logical patterns of down and upstrokes in order to execute them, particularly at fast tempos) as well as right hand balance through modified posture. In this regard, the four fingers are brought together, aligned with the plectrum-holding index in order to counterbalance the difference in strength between the thumb and index (the thumb being much stronger and dominant) which otherwise can cause weaker and inefficient up strokes. (These concepts inform sections on technique included in the instructional parts of this thesis).

During a personal conversation in November 2016 with guitarist and academic Dr James Birkett, who received direct tuition from Fripp, I learned that an integral part of his approach is what is known as the CAGED system. Fripp’s use of this method (that of relating chords, scales and arpeggios on the guitar back to the shapes of basic open C, A, G, E and D chords) in order to obtain a practical route to mastering the instrument at a harmonic and improvisational level, has been very influential , and has given guitarists trying to master the instrument something to work with which (although wasn’t equivalent) relates to the way in which piano players can visually and logically understand harmony on their instrument.

In terms of his performances and recordings, Fripp is mostly well known for his work with progressive rock band King Crimson, which became one of the pioneering bands in the genre “Crimson were pack leaders in what became known as progressive rock.

The dizzying intensity of their recorded work took the band into places that most others were simply incapable of reaching” (Hughes, 2014). Nonetheless, Fripp’s work since the beginning of his career in the 1960s includes collaborating with David Bowie, Peter Gabriel, Andy Summers, Blondie and Brian Eno, among others. In all cases, Fripp’s input is one of not just guitar virtuosity but a futuristic vision which has led him to experiment with technology and sound-processing (developing things such as the extraction of delay through the use of dual reel to reel devox tape machines).

“Do I consider myself a rock musician? Rock is a far more malleable music form than either jazz or classical. Rock is the 20<sup>th</sup> century classical music; it’s the music of our time. A musician that is interested in working in contemporary terms is best off working in rock” (Fripp, n.d.)

Crucial to an appreciation of Fripp’s work is the album *In the Court of the Crimson King*. This album was the debut album by King Crimson, released in 1969 on Atlantic Records. As an incredibly prolific musician, Fripp has actually taken part (as a session musician, collaborator, band member, or solo artist) in over 700 releases. In order to appreciate both his incredibly effective technique as well as his futuristic musical voice and vision, the album *I Advance Masked* (A&M Records) recorded in duo format in 1982 with The Police guitarist Andy Summers, is a perfect example. The first track (also titled *I Advance Masked*) provides a perfect demonstration of Fripp’s crosspicking technique as well as his accuracy and clean articulation at fast tempos. Additionally it also demonstrates one of the most important branches of Fripp’s work, which is that of joining forces with other artists.

### **Alan Holdsworth (1946)**

Alan Holdsworth has influenced guitarist from jazz to rock and beyond, in areas of both technique as well as the understanding and application of harmony on the guitar. His tone and approach to the instrument is, as with many jazz guitarists, derived from a desire to make the instrument sound like a horn (in his particular case,

a saxophone, which he originally wanted to play instead of the guitar, later settling for the guitar after his father couldn't afford the cost of the woodwind instrument).

Holdsworth is particularly associated with the fusion branch of jazz as well as progressive rock. In terms of his technique, he has developed a highly advanced use of *legato*. This started out of his desire to produce a saxophone-like sound, which the more common way of plucking the guitar made difficult to achieve. In order to do this, Holdsworth uses a combination of hammer-on and pull-off techniques, in rapid fashion and (during improvisation) often in contrasting combination with slower phrases.

Harmonically, his approach also pushes the boundaries of what is common practice on the instrument and in the jazz style. Apart from incorporating altered intervals (such as those found in the superlocrian/altered scale, the half/whole diminished scale or the whole tone scale) he often includes self-developed scales from which he then derives chord families and modes, in this way applying the traditional modal and harmonic organisation concept to new note families. One such example is the Harmonic Minor scale with a raised fourth.

“I was particularly stubborn. My dad was always around to help, but I didn't like to ask him because I wanted to figure it out on my own. So I guess I started out trying to figure everything out by using math” (Holdsworth, 2007). Indeed Holdsworth, it could be argued, utilised a scientific approach more so than his ears (as most self-taught musicians do, particularly at an early age) in order to create his own approach to learning. In doing so, he not only achieved logic but also unique sounds that are unconventional to most music making individuals.

“I figured if I started out with, say, five note scales, I could just permutate them all – one through to five; then one, two, three, four, six; then one, two, three, four, seven; etcetera; through to twelve. Then I'd do the same with six note, seven note, eight note, nine note scales. And then I catalogued them and filed them away and I threw away all the ones that had more than four semitones in a row”. (idem).

In order to get an idea of Holdsworth's work over the decades, it is important to look at his work in the 70s and 80s as well as into the 21<sup>st</sup> century. The albums *Road Games* (1983, Warner Bros) and *Metal Fatigue* (1985, Enigma) show some of his most significant and influential work during the period where his music was very much influenced by progressive rock. It also includes vocals which are also approached in that styles. On the other hand, the album *The Sixteen Men of Tain* (2000, Gnarly Geezer) demonstrates his work in a more jazz based arena, this is easily perceived from the outset in the approach and tone of not just the guitar, but the whole instrumentation.

### **Bill Frisell (1951)**

Amongst jazz guitarists of the last 30 years, Bill Frisell is certainly one of the most influential ones. His style is not only unique but, unlike many players in the jazz world, places an emphasis on the natural sound of the instrument as opposed to trying to make the guitar sound like a horn.

Frisell was taught by earlier jazz guitar great Jim Hall and, like Hall, has developed a style more focused on the creative use and application of advanced harmony in a contemporary way, than on technical virtuosity. As Frisell explains, limitations are an integral part of what makes a player develop a unique sound (2010).

Born in Baltimore, USA, in 1951, Frisell started playing the guitar through an enthusiasm for popular music, and The Beatles had a significant impact on his early years as a musician. After studying music at Northern Colorado University and the Berklee College of Music in Boston, Frisell eventually became involved in several recordings for the label ECM. This all started after Pat Metheny recommended him for a session he had been asked to participate in, but couldn't attend, with former Bill Evans trio drummer Paul Motian. Thereafter Frisell began to release albums on the label under his own name and built a reputation as one of the most exciting guitarists in contemporary jazz.

“His choice of notes is always interesting, and while he can grace any context – abstract or tightly structured – he can also boogie happily with the best; he is also an excellent composer” (Carr, 2004).

Frisell’s personality on the instrument is gentle yet powerful, involving a deliberate and elongated use of space and resonance in order to highlight the instrument’s own voice and tone colours. Additionally, his bodily movements with the instrument are also used to affect the vibration of the strings in order to produce interesting subtle effects on pitch. He has taken all of this musical personality and expressed it through many varied stylistic branches including contemporary jazz, folk music and Latin-influenced jazz.

In all cases, he is always interested in entering areas out of the comfort zone “The music will pull you ahead. There’s always something just beyond your grasp. Whatever it is I do, it’s like I am hearing something in my head and I am trying to get it. You write it down or you play it, and you are never quite there, so it just keeps pulling you ahead and pulling you ahead” (Frisell, 2009).

Two essential albums are recommended as an overview of his musical output. The album *The Best of Bill Frisell volume 1- Folk Songs* released by Nonesuch in 2009 is a perfect example of his Americana-influenced music, which is infused with his unmistakable application of resonance, space and presentation of even basic harmony in interesting ways. The album *Bill Frisell Ron Carter Paul Motian*, released in 2006 by Nonesuch is the perfect example of his approach to jazz in a contemporary way. Accompanied by Miles Davis’s and Bill Evans’s former bass player and drummer (respectively) one can hear Frisell’s use of minimalism and harmonic mastery on the instrument at its best.

### **Lee Ritenour (1952)**

Lee Ritenour is a perfect example of the many versatile, contemporary jazz guitar players of the last forty years, when jazz has merged with many other genres of

popular and folk music. He is comfortable working in several contrasting styles, from be-bop to fusion to rock and blues, as well as Latin and world music. Indeed, he is as well known for his immense experience as a session musician (which he did first) as he is for his work as an artist under his own name in the jazz genre.

“He remains one of the busiest session guitarists on account of his excellent musicianship, awareness of contemporary styles and versatility on electric and acoustic guitars” (Alexander, 2004). Some of the names with whom he has worked include Herbie Hancock, Sonny Rollins, George Benson, Earl Klugh, Peggy Lee, Aretha Franklin, Barbara Streisand, Stevie Wonder and Ray Charles.

Born in Los Angeles, United States, he studied with a series of different instructors. Interestingly, amongst them were some of the finest in both jazz and classical styles “I took lessons from Joe Pass, Barney Kessel and Howard Roberts, and I loved classical guitar as well, I was a big fan of Segovia and studied with the great classical guitarist Christopher Parkening” (Ritenour, 2013). This suggests that, even though Ritenour would not evolve in the direction of becoming a classical player as a career, his versatility and awareness of what was possible on the guitar was cultivated from an early age.

As his stylistic versatility suggests, Ritenour’s technique is very refined. His approach to the use of the plectrum is the one preferred by many, holding it between the thumb and index fingers, positioned on the inner side of the joints. His left hand is always positioned close to the strings (as his experience with the classical guitar will have reinforced), and he almost never needs to apply any abrupt movements when travelling between areas of the fretboard, possessing a particularly outstanding spatial awareness on the fretboard surface, making even very fast position changes seem slower than they actually are due to his extreme control.

A recommended recording is *Stolen Moments* (1990, GRP Records). Here, Ritenour combines his admirable technique with what many consider to be some of his best playing from a musical and artistic standpoint “Mature, passionate and focused playing” (Alexander, 2004). Additionally the album *String Theory* (2010, Concord) is



done in collaboration with several other guitarists in many styles (including George Benson, Mike Stern, John Scofield, Pat Martino, Steve Vai, Steve Lukather, Guthrie Govan, Andy Mckee and B.B King, among others), and further-demonstrates Ritenour's natural desire to constantly explore and work between different styles.

### **Pat Metheny (1954)**

Pat Metheny was born in Lees' Summit, Missouri, USA in 1954. Still in his teens, Metheny became a guitar teacher at the Miami University and briefly after at the Berklee College of Music in Boston. With vibraphonist Gary Burton, who had recommended him for his teaching position at Berklee, he performed and toured and soon gained a reputation as an outstanding young talent.

His debut album under his own name, *Bright Size Life*, introduced a contemporary sound to the traditional jazz guitar styles of previous decades, incorporating airs of Americana and folk styles that made the music not only different but appealing to audiences beyond those normally associated with jazz. Although this album didn't catapult him straight to his eventual popularity, from this point Metheny steadily built a career establishing himself as one of the most innovative musicians on the jazz scene since 1970s.

"I was very fortunate to be around musicians who demanded that you come up with your own thing. It was really drilled into my head from a very early point" he says during an interview. He continues "It was not cool to sound like Wes Montgomery, it was not cool to sound like Miles" (1997).

Like virtually any jazz star of his stature, Metheny sound is absolutely unmistakable, and different aspects of his technique are self-taught. For example, Metheny uses a rather large plectrum compared to those normally preferred by jazz guitarists and holds it in an unconventional way – gripping with the end of his fingers, rather than with the side closest to the thumb on the joint area – and incorporating several down strokes during passages of enough tempo for most other guitarists to chose alternate

picking. His overall movement of the right hand is, in comparison to most guitarist of similar accomplishment, quite exaggerated and not necessarily in-keeping with the economy-of-movement approach that most try to achieve.

A crucial element of his overall sound and improvisational style is something that all good jazz guitarists try to achieve but few master and use creatively in an equivalent way. That is the skill of delineating the harmony and basing improvised melodic lines on an awareness of this, and of the harmonic development of a piece. “To me the best players are guys who can play with just a bass line or even just drums, and you hear all of the harmonic information in the tune that they are playing” (Metheny, 2013).

In order to appreciate Metheny’s work three recordings are recommended. The album *Bright Size Life* (released in 1976 by ECM) which saw him start his solo career is the perfect introduction to his overall sound and musical voice. The album *The Way Up*, by his *Pat Metheny Group*, released nearly three decades later in 2005 by Nonesuch, is the perfect window into his musical evolution in a long form 68 minute composition divided into 4 parts, which experiments with the combination of established development of musical material and improvisation. Further to this, the album *Orchestrion* (2010, Nonesuch) has Metheny interacting with a non-digital machine designed to accompany him improvising spontaneously in a unique way.

“Pat Metheny’s music, whatever the context, has its roots in jazz, rock and country music and it is characterized by intensely melodic compositions, clear rhythms perfectly executed, and an inexhaustible flow of melodic improvisation. Metheny has an extraordinary understanding of, and insight into, the making of improvised music” (Carr, 2004).

### **Martin Taylor (1956)**

Martin Taylor has frequently been referred to as the most important solo jazz guitarist of the last three decades. His improvisation over standards incorporating not just a

melodic line but a series of spontaneous independently moving lines that incorporate bass, mid range and melody is unique and masterful. Martin's background in jazz, however, did not start in the branch of solo performance. In fact he came to popularity as the guitarist in Stephane Grapelli's band (violinist most famous for his work with Django Reinhardt).

"When I was playing single lines, it felt to me almost like a piano player playing with one hand but the other hand tied behind the back. I just knew that there were other things that we could do" (Taylor, 2016).

Taylor's technique is particularly rare in that as a jazz guitarist he incorporates elements of the classical approach to guitar playing. For example, Taylor mostly prefers to play sitting down and resting his guitar on his left thigh (this is the traditional classical posture and very rarely seen amongst jazz guitarists). Taylor also has a very conscious awareness of posture and plays with a very relaxed/straight torso as well as with minimum tension on his shoulders.

His use of plucking is certainly classical oriented, with the fingers able to easily move independently from each other and the minimum amount of movement happening from the plucking hand, as well as with the wrist positioned such a way as to minimize the amount of resistance created for the free movement of the tendons and blood stream. In fact, during his interview with me as part of this research he says he has never seriously played the classical guitar. However, when starting to play solo jazz guitar he "took much of his inspiration from listening to and watching classical guitarists and how they really got into the detail. How to produce a good tone, get into the centre of the note, and how to produce dynamics" (2015).

"He possesses a rare, double gift of brilliant musicianship and the ability of keeping a clear eye on the business of making a living at jazz without ever compromising his musical beliefs" (Fairweather, 2004).

The album *Solo* (released in 2001 by P3 music) provides a perfect example of Martin's unique work over standards as a solo guitarist. Additionally, the album *The Best of Martin Taylor* (2005, P3 Music) also includes other versions of standards by

Taylor which have become classic demonstrations of his style, such as his version of *I Got Rhythm*.

### **Frank Gambale (1958)**

A leading guitarist in the jazz fusion idiom, Gambale has toured and recorded with some of the most important musicians in jazz, including Chick Corea and Jean-Luc Ponty. Born in Canberra, Australia, he moved to the United States in his youth in order to study at the Guitar Institute of Technology in Hollywood. His playing was always admired, particularly for its outstanding technical efficiency. Even before graduating, he published his first instructional book *Speed Picking*.

One of the most important contributions which Gambale has made to the guitar-playing community is that of developing the technique of *sweep picking* which has now widespread across several styles (particularly rock, fusion and metal styles). Although Gambale was most probably not the first one to use it, he certainly took it to completely new levels of complexity and efficiency, dedicating whole instructional books and videos to its teaching. It consists of playing continuous down/up strokes for any series of notes which are on adjacent strings, in other words, always moving in the direction of the next string to be played, as opposed to continuing to alternate between down and up strokes as alternate picking suggests. This allows him to do extremely fast and smooth runs.

“I started doing this when I was in my mid-teens. I would have one note on three separate adjacent strings and to me it made no sense to do alternate (picking) in this case. I thought, why not just go straight across, it makes complete logical sense, and I like logic” (Gambale, 2014).

His technical virtuosity has at times been dominant over his musicality. “To some critics, his exceptional facility governs his choice of notes, and he is often accused of having a jazz musician’s musical knowledge and a rock musician’s aesthetic sense.

In spite of this continuing controversy, Frank Gambale is undoubtedly one of the foremost fusion guitarists to emerge in the 1980s” (Carr, 2004).

His extremely smooth technique and soloing can be heard on the album *Passages* (1994, JVC). Although the approach to playing is heavily influenced by the rock sounds of the 80s and early 90s, the influence of jazz (particularly in the harmonic and improvisational elements) is certainly vital to the music on this recording. Additionally, the album *Light Years* by the Chick Core Electric band (1987, GRP) was his recording debut with that group, which was pivotal to his career as a whole and shows his ability to comfortably work in the jazz idiom alongside some of the style’s finest.

### **Mike Walker (1962)**

Mike Walker is today regarded as one of the most accomplished jazz guitarists in the UK. His career has seen him record and perform with such jazz icons as Bill Frisell, George Russell, Dave Holland, Tal Farlow and Steve Swallow, among others. Born in Salford, he was surrounded by music from an early age, with his father playing the piano and his mother singing. However, he did not start his musical journey until later “I was never interested in music at school. I had always wanted to be an English teacher. But my brother was a rock singer who accompanied himself on guitar, and it was he who encouraged me to play the instrument. I got my first guitar pretty soon after, when I was about 16 or 17” (Walker, 2009).

He was a familiar face in the Manchester jazz and fusion scene of the 1980s, before being noticed by other musicians from across the country and being asked to participate in different projects (most notably the bands of Kenny Wheeler and Mike Gibbs).

His career saw him contribute significantly to the area of education, both privately and academically. Many jazz players in the Manchester and UK jazz scene today

have received his instruction at different points, such as Stuart McCallum , Jim Faulkner, Daniel Brew, Paul Cusick (and myself), among others.

Over the last ten to twenty years Walker has also created a reputation for himself as an artist under his own name, releasing his first solo album *Mad House and the Whole Thing There* (2008, Hidden Idiom), as well as albums in quartet format with Steve Swallow, Adam Nussbaum and Gwilym Simcock as the jazz group The Impossible Gentlemen.

Walker's technique on the guitar is characterised by high physical efficiency and a refined tone. Going to a small number of lessons with him, I personally was surprised by his attention to the quality of the stroke. Although it was nowhere near as close to the focus on tone that I experienced from classical lessons, he did dedicate time and energy to the matter more so than many jazz players and tutors I had met, and reminded me to always strive for what he liked to refer to as a *plum* note.

His approach to plectrum holding is similar to that of Robert Fripp's, in the sense that he chooses to position all fingers exactly next to, and aligned with, the index in order to counterbalance the usual greater force of the thumb and (therefore) the dominance of down strokes over up strokes in alternate picking. His left hand technique is also extremely refined. In this sense Walker manages to always keep his fingers extremely close to the strings, allowing him easy access to any note during improvisation, and contributing to an impeccable sense of continuity and smoothness in his articulation and melodic playing in general.

Mike has always been recognised for his versatility "I regularly go from one kind of music to another. I am asked to play a lot of different kinds of music: straight-ahead jazz, rocky/funky stuff, and a combination of that with some soul and crossovers of all those things" (Walker, 2009).

As a member of George Russell's band for many years, Mike absorbed a deep and profound understanding of modern applications and approaches to harmony. George Russell himself was responsible for creating the *Lydian Chromatic Concept*, which is a modern system of harmonic organisation based around the idea of looking at the

69ydian scale as the primary scale in music, given that this is the seven-note scale that results out of applying the strongest interval after the octave- the perfect fifth (as derived from the harmonic series) as a basis from which to choose notes to form a scale.

Walker's style and skill can be appreciated by listening to a number of recordings. However his previously-mentioned debut album under his own name (*Madhouse and the Whole Thing There*. 2008, Hidden Idiom) is particularly significant as it summarises Mike's many years of absorbing influences and styles as a highly skilled musician before recording as a solo artist. Additionally the self-titled debut album by the aforementioned group *The Impossible Gentlemen* is a testament not only to his playing but to (through just the members in the group) the acknowledgement of Walker as a jazz musician of the highest order by some of the most influential individuals in jazz.

## Literature review – an examination of guitar tutor books

### Approach to literature analysis

In this section I will dedicate to finding out what the general information covered in jazz and classical guitar instructional material tends to be. In order to do this, I will be consulting extensive literature, as well as instructional videos dedicated to these disciplines. This is one of the most important sources of information for guitar learning today, since players of the latest generations are easily able to access professional instructional videos for jazz and classical guitar in quantities that were never available before.

In other sections of the thesis, I have also consulted a number of sources dealing with the history and development of the guitar as an instrument, as well as sources focused on the history of the classical and jazz music genres. This has allowed me to examine the reasons that have caused the two styles to develop and evolve in the ways that they have, technically as well as conceptually.

With regard to printed material, I found relevant literature from the following five sources:

- The University of Salford library
- Other libraries
- Music shops
- Books belonging to colleagues and friends in the field
- E-Books

A full list of all the titles consulted can be found in the bibliography at the end of this thesis.



## **Jazz review**

The number of publications found which present essentially the same information to the learner in this style seems unnecessarily large, particularly when compared to those which actually try to push toward new boundaries for the instrument and how to teach it and approach it ideologically. One could argue that improvements in graphics, presentation, order and delivery of information would merit a certain amount of repetition of the actual basic content. However, beyond a certain amount, a question could be raised as to what the real necessity for this vast number of repetitive publications really is.

In this literature review I will firstly list and describe a series of examples of the most common type of jazz instructional literature, including some of the best known ones amongst the jazz guitarist's community. Thereafter, I will list those elements and content which are common between them and which can be considered to have become the standard information presented in the process of teaching how to play the jazz guitar. After providing a short discussion on these conclusions, I will discuss a series of titles which are amongst a minority in that they break away in significant ways from the tendencies of the repetitive methods, providing new visions and ways of looking at the guitar.

## Examples of the most common type of jazz guitar method

### Jeff Schroedl – Jazz Guitar

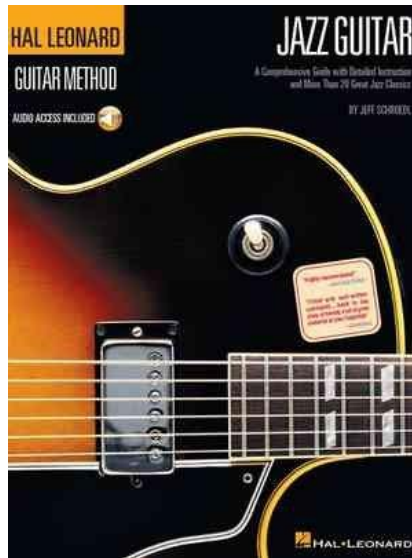

Jeff Schroedl – *Jazz Guitar* (front cover). Image 13

This is one of the methods I personally used during my many years of jazz studying. Its content is a perfect example the kind of repetitive information which is so common amongst jazz guitar instruction. The book's content is based almost completely around chords and scales and their applications in improvisation and accompanying of other musicians. Sections on augmented chords, extended chords, major, minor, melodic minor and harmonic minor scales and their modes go in detail to provide a good grounding in these subjects for the learner.

As part of the improvisation content, the book also includes guidance on how to use the learned scales to produce solos in specific subgenres including "Early Swing", "Mainstream Jazz", "Moderate Swing", "Bossa Nova", "Ballads", "Bebop" and "Uptempo Bop" among others. In a separate small section towards the end, Schroedl

also provides some guidance as to the application of the taught concepts in a solo context.

As far as technique is concerned, the book includes only one page of information with two exercises demonstrating two right hand picking approaches – *alternate picking* (the use of constantly alternating up and down strokes) and *economy picking* (an approach in which the hand always moves in the direction of the next string to be played). There is no guidance for the use of the left hand whatsoever and personal judgement and experimentation is encouraged for technical purposes in general “The basics of technique vary from player to player. Some methods lend themselves to a certain style; some are simply different ways to achieve the same end. Below are some acceptable ways of playing the guitar. Choose and develop what feels and sounds best to you” (Schroedl, 2000. P.7).

### Jody Fisher – Jazz Guitar the Complete Method

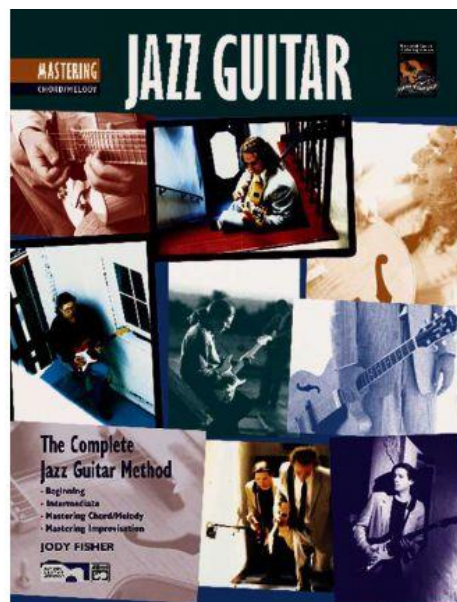

Jody Fisher – *Jazz Guitar Complete Method* (front cover). Image 14

This method presents information in two main categories, which the author refers to as “chords and harmony” (where the student is guided through theoretical concepts) and “improvisation” (where the knowledge of scales and chords is put into its practical applications).

The concepts and information presented are based around chords, scales and improvisation. As with Jeff Schroeld’s *Jazz Guitar*, these aspects of guitar playing and music are covered in great detail in this method, leaving the dedicated student with a thorough understanding of the harmonic and theoretical aspects that form the building blocks of composition and improvisation.

There are other small segments dedicated to effective practice approaches, how to develop solos structurally, as well as a short section on technique. This section is fairly extensive when compared to the majority of other jazz methods. Nonetheless, it is very limited in the exercises and guidance it provides when compared to almost any classical guitar equivalent, offering four of over 96 pages of content to technical development and practice. In these pages, there are five short sections titled “basic left and right hand technique”, “posture”, “basic strumming technique”, “fingerstyle chords” and “pick and fingers technique”.

Interestingly, instead of being at the start of the book, and before any use of the instrument is done, this section is included at the very end of the book, in what it presents as a “Coda – A Medley of Suggestions and musical concepts” after the main body of the text. It seems evident that whatever information is presented here, it is not worth mentioning it until the learner has gone through a previous 85 pages of instruction to do with other aspects of music – namely chords, scales, harmony and improvisation. This is contrastingly different to basically any method dedicated to teaching the classical guitar, where all the essentials of technique are presented to the student before he/she starts using the instrument, and are thereafter followed by several exercises designed for developing that technique and getting accustomed to it. The same process is also followed later on when learning any further (more advanced) techniques.

## Ronny Lee – Jazz Guitar Method

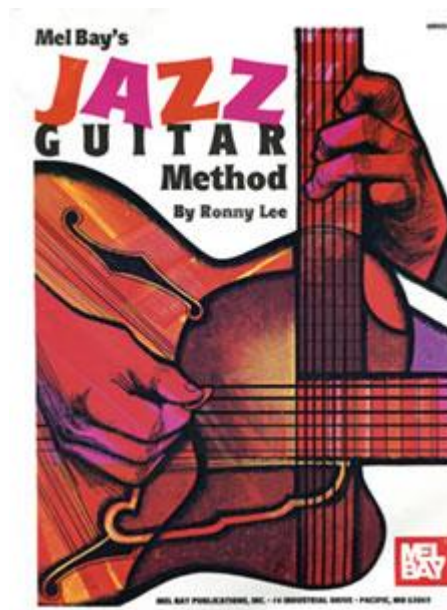

Ronny Lee – *Jazz Guitar Method* (front cover). Image 15

This traditional method dates back to 1962 and is described by the publisher (Mel Bay) in the foreword (p. 2) as “the easiest and most practical approach to jazz guitar playing I have ever seen”. It is interesting to think that, at this time and compared to today, books dedicated to the teaching of jazz guitar were still fairly uncommon, which would have likely made this book originate particular excitement amongst producers and readers alike.

As with most jazz guitar methods, this book considers the subject of harmony and theory of paramount importance for the study of jazz. This is clear after reading the author’s very first sentence to the reader “Our first step in learning to play jazz is to develop an understanding of music theory. To know theory is to possess the tools with which to play jazz”. (Lee, 1962, p. 4). This statement alone highlights a significant difference between the priorities which tend to drive jazz guitar methods and those which are revealed amongst classical guitar instructional literature, which

is mostly concerned (as will later be discussed) with advanced technical proficiency and repertoire.

This is the beginning of an initial 22 pages of *Nine Stepping Stones* initiating the guitarist on what is basically music theory, including intervals, scales, key signatures and the construction of different chord types as originated from scales. Following this section, Lee introduces the concept of soloing in a second main chapter of the book titled *Jazz Solo Course*, in which he defines jazz as a “musical line which, when played in place of the melody (song), will blend with the chord accompaniment that is intended for the song melody”. (Lee, 1962, p. 24).

It is interesting to think that, by this point, the student of this book will have absorbed information to do with fairly advanced music theory and chord construction, and will start looking at the ways in which several different scales apply to composing and improvising melodic lines, whilst not having been given any information whatsoever regarding how to hold the instrument, how to use the plectrum/fingers, how to best dial and pick the strings, or in general how to effectively and logically approach the instrument from a physical and mechanical perspective.

## Les Wise – Jazz Improvisation for Guitar

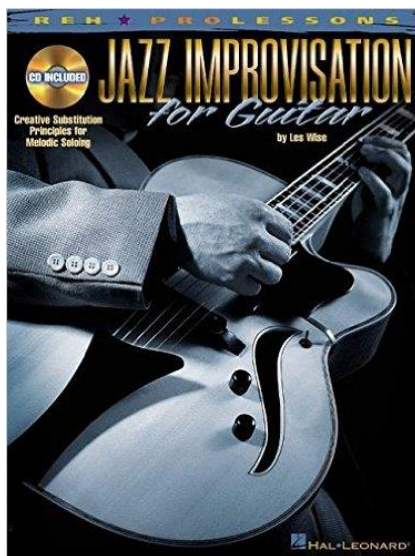

Les Wise – *Jazz Improvisation for Guitar* (front cover). Image 16

This title could be considered to have a slightly more specialist aim amongst jazz guitar instructional literature. As the title suggests, the author is not necessarily concerned with providing the student with a full course on the whole of jazz guitar, but is instead looking to give guidance on the improvisational aspect. In this respect the author describes the purpose of the book as being to “equip the guitarist with the necessary tools to make the transition from playing disjointed scales and arpeggios to playing melodic solos that maintain continuity and interest for the listener”. (Wise, 2001, p. 3).

With this aim, Wise presents a series of lessons based around music theory as applied to the guitar, which intend to provide the player with tools that will help them to create melodic lines over chord progressions. Amongst these are “Scale Harmonisation”, “Major Scale Patterns”, “Altered Tension with the Major Scale”, “Altered Tension with the ii-V-I Progression”, “Melodic Minor Scale and Arpeggio Forms”, “The harmonic Minor Scale” and “Minor ii-V-i Chord Progressions”.

Whilst being dedicated to the melodic soloing aspect of jazz, the building blocks that make up the book (with the author’s own way of presenting it) are still very much

those found in the vast majority of jazz guitar methods: harmony, chords, scales, arpeggios and their use in improvisation. As with many titles of its kind, after the mentioned aspects have been extensively covered, there is a little extra guidance on some additional topics at the very end. In this case, the last three pages of the book are dedicated to “Jazz Guitar Thinking”, “Resolution in Soloing” and “Putting it all Together” respectively.

Interestingly (but perhaps by this point not surprisingly) for a book dedicated to teaching how to play what can be technically very complicated and demanding music for the player, there is no guidance whatsoever as far as anything related to technique on the instrument.

### **Jerry Hahn – Complete Jazz Guitar Method**

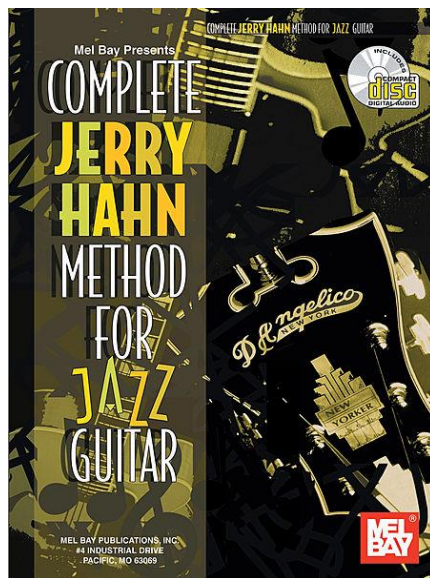

Jerry Hahn – *Complete Jazz Guitar Method* (front cover). Image 17

In this method from 1986 (and after a career that saw him play with such renowned artists as Gary Burton, Steve Swallow, Jack DeJohnette, Roy Haynes and Paul



Simon) Hahn presents all the standard information included in the previously mentioned books as the building blocks for playing jazz guitar. Starting with a few basic suggestions about how to approach practice, understanding notational symbols and fingerboard charts, as well as a one page segment on picking techniques; Hahn soon enters the main topics of scales, chords and arpeggios. Nonetheless, although the guidance on technique is very limited when compared to almost any classical method, it does have more information regarding this aspect of guitar playing than most jazz methods, particularly in later chapters in the book.

Of particular interest is the fact that there is some guidance regarding the good use of the left hand (albeit through an exercise mostly designed for right hand *alternative* picking) something even rarer for a jazz guitar book. “Exercise #1 is a helpful exercise to teach a beginner in order to establish a good left hand position. When practicing exercise #1, the fingers should not be lifted until there is a change of string” (Hahn, 1986, p. 10). Interestingly this kind of advice encourages technical practice which (apart from being very rare amongst jazz guitar instructional material) is very much of the same kind that would be presented to a beginning classical guitarist in any regular instructional book of that style. It forms part of a three page segment on *basic warm-ups*.

On pages 57 through to 65, Hahn returns for the last time to the area of technical advice, providing further exercises for the practice of *alternating picking* and *cross picking*. Again, the exercises are intended for the right hand, but also aid to the development of good left hand technique “The following exercise is one of the best right-hand workouts I know; however it is also very good for the left hand”. (Hahn, 1986, p. 57).

A little more technical content would make this book almost adequate as an example of the non-repetitive literature which is covered in the next section of this chapter. However, the advice on technique found here is still very limited and basic, and the rest of the book does not point in any real different direction conceptually to all the other books in this section of the thesis.

## Mickey Baker – Mickey Baker's Complete Course in Jazz Guitar

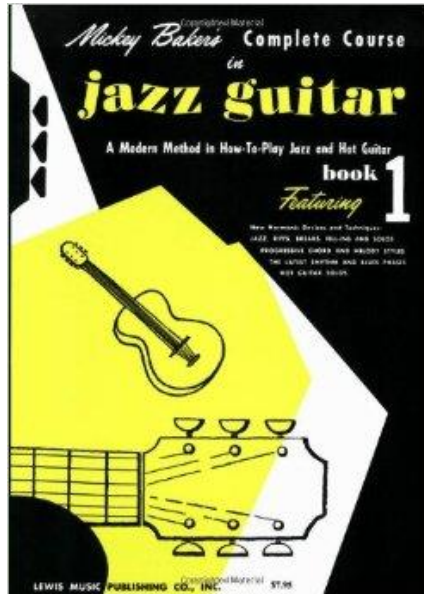

Mickey Baker – *Mickey Baker's Complete Course in Jazz Guitar* (front cover).

Image 18

Like most of the books of its genre, this particular title is designed as a guide to the harmonic and improvisational aspects of jazz guitar playing. “Part One” of the book dedicates to training the student about chord diagrams, thereafter linking this knowledge with the concept of melodic construction. Shortly after this, arpeggios are introduced and, with that knowledge, Baker then guides the student through more advanced concepts about harmony and how to transpose the information learned to different important keys.

“Part Two” is more vastly dedicated to melodic ideas. Many scales are introduced, whilst different examples of improvised runs over different types of harmonies are

provided, “Minor Seventh Runs”, “Dominant Seventh and Ninth Runs”, “Blues Solos”, “Solo Sketches” and “Building around the Melody” are some of the sections dedicated to this. Once again, the author gives improvisation and soloing paramount importance amongst all aspects of playing, “Now that you know how to use chords, let’s go into the most important study which is solo work” (Baker, 1955, p. 26).

Unsurprisingly, Baker’s book stands with the majority of jazz instructional material in that it has no guidance as far as technique is concerned. In this particular case, there are literally no chapters or suggestions in this regard.

### **Mike Christiansen – Complete Jazz Guitar Method**

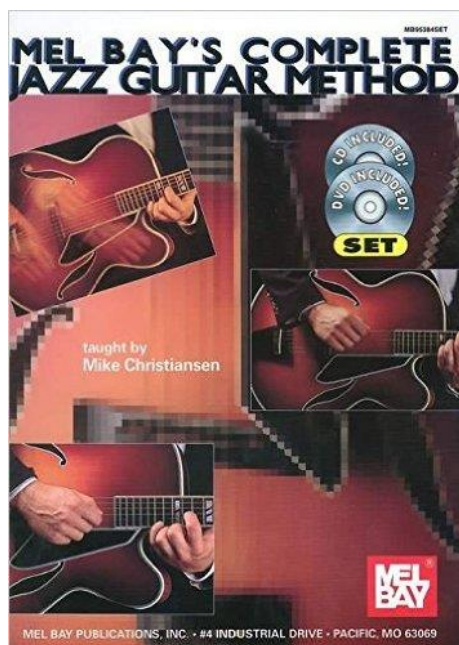

Mike Christiansen – *Complete Jazz Guitar Method* (front cover). Image19

In this method, Mike Christiansen takes the student from very basic rudiments of music reading and writing (such as note values and chord symbols), to advanced

harmonic and melodic concepts such as quartal harmony, chord substitution, harmonic alterations and the super locrian mode. In all of these subjects, he directs the teaching as applied directly to the guitar.

Apart from teaching the students theoretical concepts and advanced scales and chords, the book also includes guidance regarding how to creatively approach music making and improvisation on the guitar, from the point of view of development. For example, there are sections such as “Constructing a solo” and “Phrasing”, where intricacies beyond compatibility between harmony and melody are discussed.

There is no information regarding technique for playing the guitar in this book, however. This once again indicates that, for most jazz guitarists, authors and teachers, technique is not something that requires the dedicated and thorough guidance that is given to subjects such as chords, harmonic progressions, scales, arpeggios and improvisation.

### **John Scofield – Jazz Funk Guitar (Instructional video)**

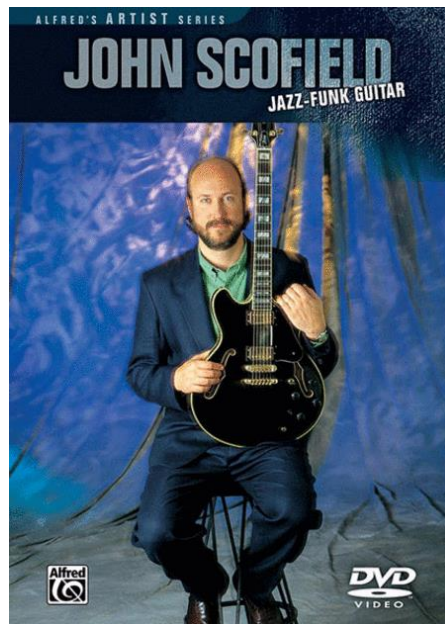

John Scofield – *Jazz-Funk Guitar* (front cover). Image 20

John Scofield is one of the most well-known and celebrated jazz guitarists of the last 30 to 40 years. In this instructional video, Scofield explains and demonstrates many aspects which are essential to his guitar style. There is plenty of information regarding how to improvise, including being able to play melodically freely across the guitar fretboard, as opposed to being locked inside in-position scale patterns. There is also guidance for players trying to make a transition from knowing all the theory of scales and chords to being able to use them in a fully creative way. Amongst all other important features Scofield mentions the importance of rhythm “Some people think that rhythm is the most important feature, and in the kind of music that we play, maybe so” (Scofield, 1992).

Lastly, there is a chapter on technique where Scofield’s explains his approach to the use of the right hand. He explains that he uses the plectrum extensively but that, when playing chords, he likes to be able to play all notes simultaneously as opposed to one after the other (as would be the case with a plectrum stroke). For this reason he plucks with his fingers and thumb in these cases, whilst tucking the plectrum between his fingers. In developing this technique, although he tried playing a couple of Bach pieces in the past on a classical guitar, he says that the approach came out of “playing around in the living room and necessity” (ibid).

As with all other material in the jazz genre, it is perhaps not surprising that Scofield’s video presents a very minimal amount of information on technique. But perhaps most important is his personal statement which reveals that his right hand technique (at least a major part of it) was developed by himself and out of necessity, rather than with any kind of structured guidance or instruction.

Larry Coryell – Larry Coryell’s Jazz Guitar volumes I, II and III (Instructional video)

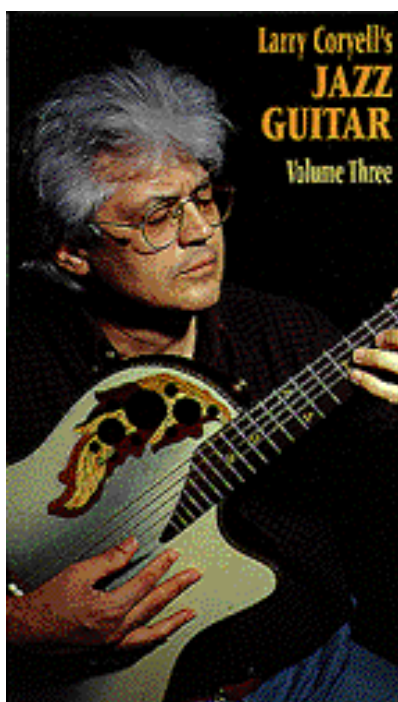

Larry Coryell – *Larry Coryell’s Jazz Guitar* (front cover). Image 21

In this video, Larry Coryell gives insight into his approach to playing the jazz guitar. All of the areas previously found in learning sources as being the main building blocks of jazz guitar music and learning are covered, including chord knowledge and theory, arpeggios, scales, modes and improvisation. Coryell also includes demonstrations of improvisation over different pieces, as well as case studies of how to improvise over some of the most established jazz standards, including *Stella by Starlight* and *Giant Steps*.

Outside of these aspects of learning, and in contrast with most other jazz instructional material analysed, Coryell starts this instructional material by talking about posture. He starts this segment by pointing out that, in his experience, this is an area that does not received enough attention “something very overlooked at times in my own *guitaristic* past has been paying attention to holding the instrument” (Coryell, 1997).

He continues by talking about how he positions his guitar in such a way that is comfortable for him. In this regard, Coryell's message is not so much one of trying to tell the learner to adopt a specific posture, but to simply pay attention to this matter to make sure that he/she has easy access to the instrument and avoids unnecessary tension on the shoulders as well as on the back and neck. Sitting down for the purpose of playing for the video, Coryell says "Very often I'll stand and play. I keep the same strap adjustment – it seems to work just fine. But of course when you are standing up you are going to have to use more of your body, in my case I use more of my right leg sometimes when I am doing some stuff. But, again, that is going to have to be according to your own specifications. That is going to be something that you work out yourself, but the point is to pay attention to your position. We all need to have as good a posture as possible" (ibid).

Unlike almost any classical guitar method, Coryell does not present a specific approach that should be taken in order to achieve good posture. However, contrastingly from the majority of jazz methods, he starts the teaching of the style by talking about the importance of this aspect of playing and how it will affect everything that will follow. It is also interesting to hear one of the most acclaimed jazz guitar players of his generation mentioning that, in his own experience, this is an aspect of playing that is very overlooked, as it coincides perfectly with the evidence gathered this far regarding jazz guitar instructional material, as well as with my own personal experience as a student of jazz.

In the remainder of the volumes and teaching chapters, Coryell goes deeply into the previously mentioned standard jazz idiom subjects of harmony and improvisations. Nonetheless, in the last volume he discusses advanced techniques including sweep picking, back picking as well as pick and finger applications. Interestingly, however, no guidance is given as far as the basic use of the plectrum and how to hold it, or how to approach basic strokes on the strings.

**Joe Pass – Jazz Lines and An Evening with Joe pass (Instructional clinic and accompanying lesson)**

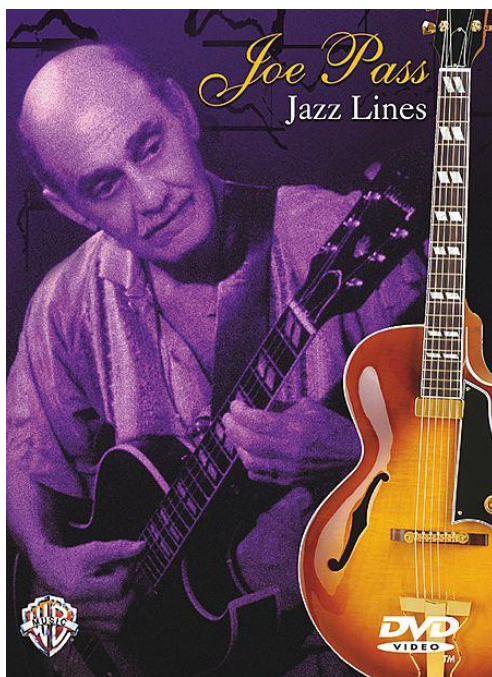

Joe Pass – *Jazz Lines* (front cover). Image 22

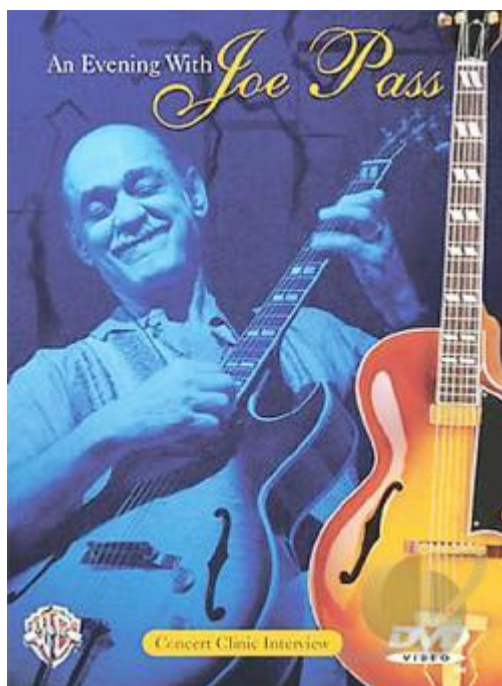

Joe Pass – *An Evening with Joe Pass* (front cover). Image 23



In this two-volume video series, Jazz guitar legend Joe Pass answers a series of questions regarding his knowledge of the jazz guitar style in a clinic setting. In the accompanying *Jazz Lines* video, Joe provides guidance and ideas for melodic playing over different harmonic backgrounds, including major, minor, dominant and altered seventh chords. Most of the information discussed in both videos is concerned with the subject of improvisation, as well as the understanding of the harmonic components that are essential to jazz. Importantly in this regard, Pass discusses his view of the whole harmonic spectrum as simply contained between four basic branches: major, minor, dominant and diminished.

In the *Jazz Lines* volume, Pass very briefly describes his left and right hand techniques. As far as the right hand is concerned he says “It is a good idea to learn to play with your fingers. It’s not hard to do, you just put your hand on the guitar and sit there watching the television set for a while and your fingers will fall the way they are most comfortable, which is not the classical way. They will fall for yourself, the way they are most comfortable. You can play a lot freer with your fingers, especially if you are playing solo guitar”. He later continues “I don’t have any system, and you don’t need a system, only what works good for you” (Pass, 1989).

He also mentions a series of what he calls *idiosyncrasies* as far as picking, for example always using two downstrokes when changing strings downwards, and using half a plectrum instead of a normal plectrum.

## Mike Stern – Guitar Instructional Video

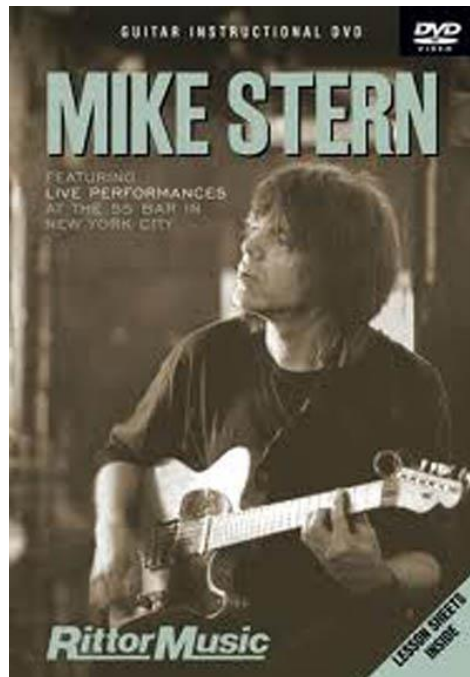

Mike Stern – *Guitar instructional Video* (front cover). Image 24

In this instructional video, jazz guitarist Mike Stern gives insight into his approach to improvisation through a series of performances which are then discussed in an interview format with fellow jazz guitarist Satoshi Inoue. The vast majority of the material consists of explanations based on harmonic understanding which is then utilized to create melodic phrases over chord sequences.

Stern describes what his thought process is during the creation of lines played during the performances as well as his choice of gear and practice routine. There are no sections dedicated to technique. However, the subject of technique does present itself occasionally. In this regard, Stern says “My picking technique has always been up and down (alternate picking). Picking all the notes but making them sound like some are ghosted, like the way we talk – we don’t talk very evenly like robots. Certain syllables are softer”. He later adds “You don’t think about it but there’s a rolling

dynamic when you are talking, and I try to get that happening in my playing” (Stern, 2001).

*Based on the evidence gathered, we can conclude that the standard information presented within teaching material for the jazz guitar is the following:*

- Chords (triads, sixth chords, seventh chords, extended chords, altered chords, add chords, sus chords, diminished chords, half diminished chords)
- Scales (major and natural minor scales, harmonic minor scale, melodic minor scale, major scale modes, melodic minor scale modes – particularly superlocrian/altered scale, whole tone scale, diminished scale)
- Arpeggios (of all the above named chords)
- Chord Inversions (first Inversion, second Inversion, third Inversion)
- Chord Substitutions (such as tritone substitution and secondary dominant, as well as related diatonic chords, such as replacing chord I with chord vi)
- How to delineate harmonies melodically (based on the use of the arpeggios of the chords)
- Melodic improvisation over moving harmonies (usually including common jazz chord sequences such as ii-V-I, blues sequences and vi-ii-V-I)
- Improvisation over key changes (frequently incorporating pieces, or excerpts, from the standard jazz repertoire)
- How to approach a solo creatively (through the combination of all melodic resources as well as phrasing, form, rhythmic development, intervallic playing) and how to develop melodic ideas
- Combining all of the above to create solo performances and arrangements on the guitar, which incorporate melodic lines, as well as bass lines and presentation of the harmony through implication, as well as chords. Many books refer to this area of performance as a separate specialist skill which is not necessarily amongst the requirements that a guitarist should strive to master in order to be considered competent in the style as a whole. In practice, the jazz guitar is certainly mostly played as an instrument within a

group, whilst only occasionally being played as a solo instrument by a much smaller number of players.

### **Repetitive literature**

From these overall building blocks, authors lead learners towards an understanding of harmony and chord knowledge on their instrument, as well as of melodic construction that is based on a predominant principle. This principle is that of utilizing the notes of the harmony as the basis from which to create melodies. This method will create sounds that are musically satisfactory based on the harmonic relationship and correspondence between the two. Beyond this basic principle, guitarists learn to use the remaining scale and chromatic notes as a source from which to create embellishment and an interesting interaction between tension and release. Some tools used for this effect are the modes of the major scale, the modes of the melodic minor scale, the modes of the harmonic minor scale, the whole tone and diminished scales, the chromatic scale, neighbour notes, passing notes, as well as the use of large intervals within the construction of melodies.

Importantly, we can see how none of these books, designed specifically to teach the jazz style of guitar playing, provide any in depth guidance regarding how to approach the instrument technically, with most providing none at all. For those which do, the information is very superficial, often taking just one or two pages of the whole book, and often included towards the end, after the main body of the text. The same phenomenon is found in the video material consulted, where the subject of technique is (if at all) only briefly and superficially mentioned, and there are virtually no exercises provided to develop any particular technique.

This evidence gives a good picture of the role of technique within jazz instructional material and how it sits within the priorities of most guitarists and tutors. It is therefore not surprising that when observing different jazz guitarists, one is very likely to see significant differences between their technical approaches. Whilst many players in

this style develop a good standard of technique, necessary to play advanced music, given the lack of guidance in this aspect from teaching resources and teachers themselves, we could say that self-tuition is the cause for the techniques that jazz guitarists tend to possess, or not possess.

### **Fresh approaches (titles that break away from the tendencies of repetitive methods)**

As far as new visions or philosophies regarding the instrument are concerned, there are a smaller number of players whose instructional books have provided a different or fresh approach to jazz and to teaching the style on the guitar. Most of these books have been printed in the last twenty to thirty years. This is consistent with the wider establishment of jazz itself as an academic style of music which is taught at an advanced level all over the world. Following are some of the instructional books that stand out amongst these due to their innovative nature:

#### **Pat Martino – Linear Expressions**

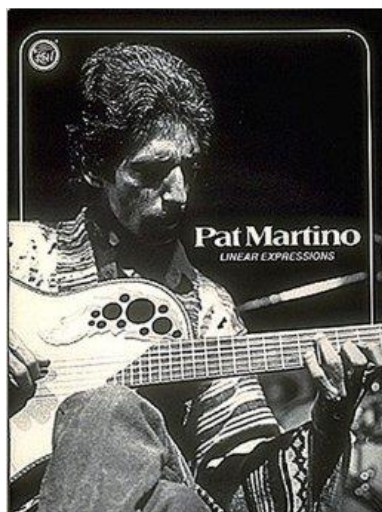

Pat Martino – *Linear Expressions* (front cover). Image 25

As a jazz musician, Martino emerged in the 1960s New York jazz scene, and famously lived with legendary musician and guitarist Les Paul for a period of time, whilst playing with such notable artists as Jimmy Smith and Don Patterson. He gradually became established in the city's scene as a sideman as well as a solo musician, working constantly through an era which produced some of the most celebrated jazz guitarists in the twentieth century. During an interview in 2009 at the National Jazz Museum in Harlem, New York, he mentions anecdotes from the sixties such as finishing performing early in the morning (after playing all night) in New York, and meeting Wes Montgomery, Grant Green, George Benson and Les Paul for breakfast.

Martino's approach to the guitar is characterized by a mathematical vision of the way the instrument's register is set out on the strings. In his book *Linear Expressions* (1989), he gives a fresh look at how guitarists learning to improvise can have an alternative way of looking at scale and chord relationships and equivalencies, reducing the number of scale and chord shapes that a player needs to master before they can improvise freely over any chord, chord sequence, or key change. To do this, Martino asks that the student associates any presented chord (regardless of whether it is major, minor, dominant, augmented, diminished, or half diminished) with a particular minor scale/chord form.

As an example, Martino presents the possibility to play/improvise over an altered dominant chord, by going up a semitone from the root of the chord and using either a melodic minor or harmonic minor scale. In this case the notes of the chord and scale would have the following relationship (explained by using a Gb7 altered chord):

G melodic minor:	G	A	Bb	C	D	E	F#
Relation to Gb 7 altered:	b9	#9	3	b5	#5	b7	Root

Whilst this in fact becomes equivalent to using what in more conventional approaches is known as the superlocrian – 7<sup>th</sup> mode – of the melodic minor scale (also known as the altered scale), Martino provides a way of accessing these improvisational resources without actually learning the more complicated theory of all

the modes of a melodic minor scale. Similarly, he also presents the possibility to play a harmonic minor scale up a semitone from altered chords, whilst stressing that in that case the b7 which is (as he puts it) the “hot” note of that particular chord, will not be present and a 6<sup>th</sup> will be incorporated. As with these examples, in this book Martino associates all possible chord types over which the player might need to improvise with one or a series of minor scale forms, therefore allowing the player to look at the demands of improvisation from a less complicated point of view.

Both in the introductory and closing sections of the book, however, Martino states that he considers improvisation to be an involved activity which should not be mistaken as a simple task. He also encourages the student to explore a series of different methods as an optimum approach to completely mastering the art form. Beyond this particular publication, Martino has also recorded other instructional videos and theories related to the same principle of looking at the alternative ways in which the fretboard and its possibilities can be observed and examined. Examples are the *Pat Martino – Creative Force (2007)* and *Pat Martino – Quantum Guitar (2008)* instructional videos.

### **Mick Goodrick – The Advancing Guitarist**



Mick Goodrick – *The Advancing Guitarist* (front cover). Image 26

Mick Goodrick has been one of the most influential educators in the history of jazz guitar, as well as being actively involved in recordings and live performances with major artists - such as Gary Burton and Steve Swallow - as well as under his own name. As a teacher he has worked at the New England Conservatory and Berklee College of Music in the United States, and has instructed such influential guitarists as Pat Metheny, Bill Frisell and John Scofield. His outlook on the instrument, as revealed through his published instructional material, has been one of trying to understand the guitar and its possibilities as a whole, beyond the stylistic confinements (although he and his material are mainly associated with jazz) of a particular style.

This was strongly revealed in his first publication *The Advancing Guitarist* (1987). Here, it is interesting to see how Goodrick actually makes reference to some concepts which are an important part of classical guitar tuition (and most often ignored within instructional jazz material). For example, in the chapter *Playing Up and Down a Single String* he shows the different ways in which the left hand fingers are actually able to move through one single string. Amongst these ways is a technique which he names *Hand-carriers* or *Shifts* which he defines as “Moving to a higher pitch note with a lower numerical finger, or moving to a lower pitched note with a higher numerical finger, linking two or more finger groupings” (Goodrick, 1987, p. 11). This is in fact one of the main ways in which classical guitarists are trained (from the early stages of inter-position playing) to connect the different positions across the fretboard. Goodrick here links these movement techniques with exercises on improvisation on single strings, forcing the student to thoroughly master the melodic resources of each string and think creatively, blocking out any previously conceived phrases or finger movements based on playing in-position across different strings.

Importantly, this book gets the (most likely jazz) student to look at the whole of guitar technique as an essential aspect of playing the guitar and as something that should be broken down and approached strategically, with guidance. Although the amount of information regarding technique is not as extensive as with most classical methods, it is considerably more informative in this respect than most jazz instructional books. As



a further example, Goodrick later mentions the possibility to change the tone quality of the note by attacking it in different places. In his Final Commentaries section, he also points out that as for harmony on the guitar, “The full harmonic potential of the guitar can only be realized if you play fingerstyle. Short of that, pick and fingers would be the next logical choice” (Goodrick, 1987, p. 87). Finally, towards the end of the book, he provides a section exclusively on technique and explains many concepts which are, again, viewed in the same way within classical schools. He mentions the importance of the way we use not only our hands, but our wrist, arms, shoulders, neck and back in order to play the instrument effectively and he describes Efficiency of Energy Expenditure as “Using the exact amount of energy for whatever task at hand requires – no more and no less”. (Goodrick, 1987, p. 93).

### **Richard J. Nail – Jazz Guitar with Classical Techniques**

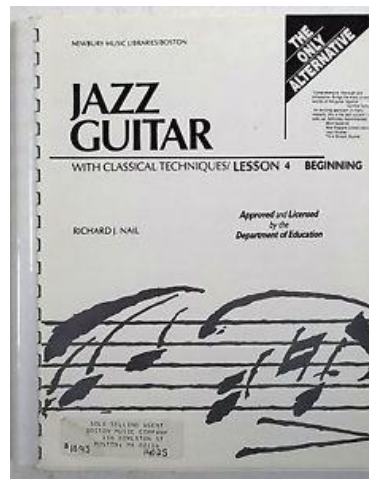

Richard J. Nail – *Jazz Guitar with Classical Techniques* (front cover). Image 27

This particular book was pointed out to me during my interview with classical and jazz guitarist David Oakes (whose books I have also used and which form a part of this thesis). On this occasion, he mentioned to me that although the idea of connecting classical and jazz guitar is not new, there is little accessible literature that deals with the barriers and difficulties facing players attempting to do it (this is an important finding of this research which comments like this have reinforced).

His book intends to equip the player with practical musical skills for jazz playing, and with a strong grounding in harmonic understanding and the relationship between harmony and melodic construction. To do this, unlike many books, Nail gets the learner to study things such as solfege (associating scale degrees with syllables – re-mi-fa-sol-la-ti-do) as well as to learn and analyse pieces in the 17<sup>th</sup> and 18<sup>th</sup> century Baroque style. This is all in addition to the general terminology and concepts that are usually applied in jazz learning such as scales, chord symbols and roman numerical analysis of chord progressions. The previously mentioned author of *The Advancing Guitarist* (1987), Mick Goodrick (1975), actually appears on the front cover of this book recommending it as “An exciting approach in many respects. This is the best system I’ve seen yet, definitely recommended”.

### **Andrew Green – Jazz Guitar Technique**

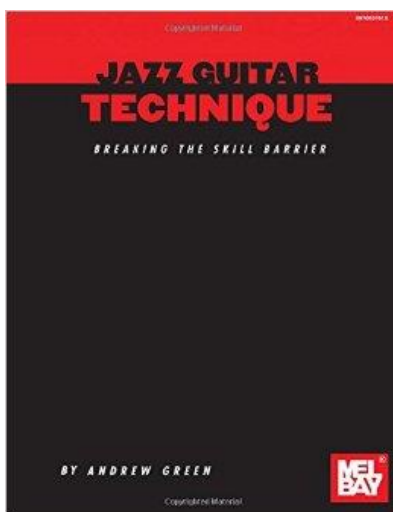

Andrew Green - *Jazz Guitar Technique* (front cover). Image 28

Amongst literature dedicated to jazz guitar instruction, it is rare to see a book dedicated to developing technique. One of the main differences between jazz and classical guitar instruction (and general ideology) is in fact the contrasting priorities between them. The focus on harmonic awareness and improvisation that exists in jazz books and instructional material often sees guidance on physical technique

being left for the student to develop by other means. This book is particularly unusual in that it breaks that tradition. It is aimed at jazz guitarists specifically, yet its main focus is the development and refinement of the motor skills required to play the instrument effectively. Green addresses such problems and technical areas as:

- The limitations that an improviser can find if he/she hears a line in their mind but can only play it in a particular position on the neck, creating an obstacle in the flow of melodic lines if the player doesn't happen to currently be in that position.
- Picking efficiency and how to develop stamina and control when playing melodic phrases.
- The challenge of picking consecutive notes on different strings of the guitar- as opposed to playing two or more notes on the same string. This is often encountered in jazz since advanced improvised melodic ideas often involve large intervals and arpeggio-based lines.
- Jazz-based approaches to accenting within melodic phrases. This basically looks at accenting notes outside the predictable strongest beats of bars and metres in order to add interest to lines.
- Technique building for chords. Here Green provides guidance to train the fingers to effectively move between the vast number of shapes that jazz harmony demands from players, as well as how to effectively and quickly navigate horizontally through chords on different areas of the guitar neck.

## Ted Greene – Modern Chord progressions - Jazz and Classical Voicings for Guitar

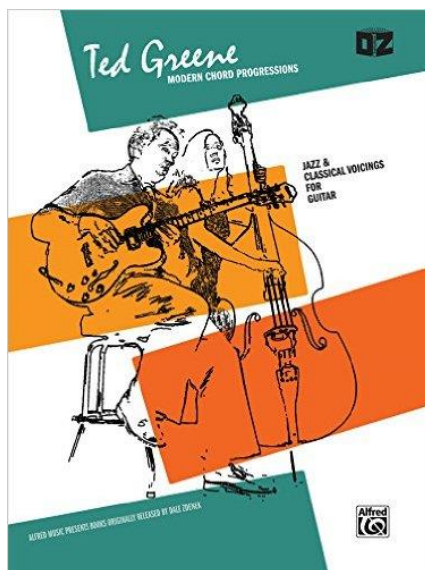

Ted Greene – *Modern Chord Progressions* (front cover). Image 29

Ted Greene was a highly respected guitarist in Los Angeles, California for several decades until his death in 2005. He was also highly regarded as an educator, teaching at Los Angeles State University. He produced a series of books on topics such as jazz single line improvisation, harmony on the guitar and chord progressions. Whilst all of them provide very valuable information on vital aspects of jazz playing, this particular book looks at the logic involved in the movement between chords and specifically its representation on the guitar neck.

It provides a great and fresh look at how learners can understand not only how to play harmonic patterns on the instrument and their particular theoretical origin, but how single voices in the harmony move from chord to chord. Green also presents a series of techniques for understanding the way many chords on the guitar will change their shape depending on the strings that they are played on, and how to quickly find ways to move voicings and shapes between strings.

In more advanced areas of the book, he also presents a series of mechanisms to, as he calls it, “decorate” the notes within chords. He does this by “delaying” some notes

of the chord voicing (e.g. in a four note voicing- playing two notes together first, and then adding the other two immediately after), and by adding moving lines (e.g. preceding chord notes with a diatonic scale note before applying the chord with the 'delaying' concept). Green mentions jazz guitarist George Van Eps as an influence in this segment of the book, and in fact the principles which he manages to explain with these ideas are some of the important building blocks that are used in the challenging field of solo jazz guitar playing, where harmony, melody and rhythm are all presented through one instrument.

### George Van Eps – George Van Eps Guitar Method

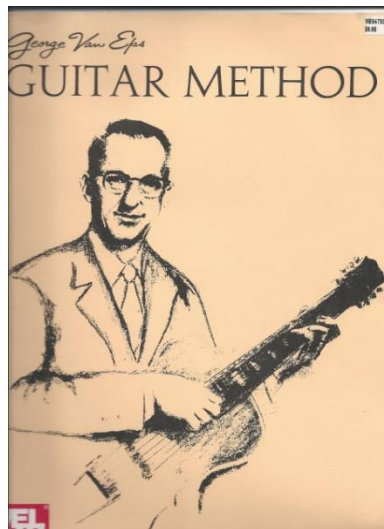

George Van Eps – *George Van Eps Guitar Method* (front cover of Mel Bay reprint from 1993). Image 30

George Van Eps is a major figure in the development of jazz guitar. Emerging from the swing era, he later incorporated principles for solo jazz guitar that were innovative amongst guitarists at the time and which are still used by many solo guitarists today, including using finger picking and incorporating drop voicings and chord-melody. With his books (notably *Harmonic Mechanisms 1, 2 and 3*) he helped pave the way for the advanced knowledge of chord voicings that is today shown in books such as Mick Goodrick's *Almanacs* of guitar voice-leading.

However his book *The George Van Eps Guitar Method* was of particular interest to me because, unlike most methods for the jazz guitar, it provides some guidance (albeit limited) in the technical approach to the instrument and how to achieve good posture. Interestingly, Van Eps instructs the student to hold the guitar by crossing his left leg over his right and resting the guitar's lower curvature on the left leg, and also encourages him/her to lean forward. This is interesting for me, personally, because it goes very much against the principles of classical posture (where the legs should be kept separate, with the left leg being raised by a footstool, and the torso kept straight). Other instructions he includes, however, coincide with classical technique, such as encouraging the learner to keep the left hand thumb roughly in the middle of the back of the neck and never allowing it to raise above the fingerboard (as opposed to the thumb-above-neck posture that many jazz guitarists like to use – at times using it to play bass notes), and keeping left hand fingers which aren't in use close to the strings in order to keep them in the optimum position to be used again.

## Jimmy Wyble – The Art of Two-Line Improvisation

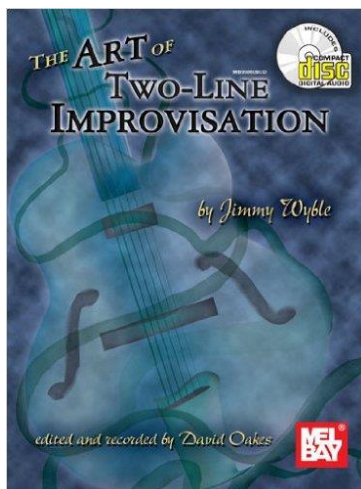

Jimmy Wyble – *The Art of Two-Line Improvisation* (front cover). Image 31

As a guitarist, Jimmy Wyble made harmonic advances on the solo jazz style which are certainly outstanding. His career saw him play with Frank Sinatra, Benny Goodman and Barney Kessel. However, as a solo artist perhaps he never achieved the recognition he deserved. In the 1970's he developed a personal style of solo guitar based on two part guitar improvising. Here he incorporated complicated broken chord shapes which he then manages to use as independent improvised moving lines. Additionally, he then incorporates advanced contrapuntal ideas between the separate lines which in general are not common in the jazz idiom. The whole approach is indeed very advanced and moves outside of the conventional jazz guitar improviser's use of melody, harmony and rhythm.

In more recent years, guitarists David Oakes and Ron Berman have taken the job of editing and transcribing much of Wyble's etudes in this style. The result has been two outstanding books which are of great value to any advanced jazz guitarists wishing to find fresh approaches and ideas for what the guitar can do, particularly in a solo context. The Books are *The Art of Two Line Improvisation* (2001) and *Concepts for the Classical and Jazz Guitar* (2000).

The first is a collection of exercises and etudes which introduce some of Wyble's two-line contrapuntal improvisation techniques, as well as a collection of his etudes in that

style. The second is a selection of exercises demonstrating options in harmonization for the guitar, combining single line with two part harmonization. Interestingly it is directed not only at jazz players and improvisers but also at classical guitarists, composers and arrangers.

## **Classical review**

The number of instructional publications dedicated to students of the classical guitar is also very large. As an academic style, this branch of guitar playing has been established for longer and major instructional books can be traced back to the 19<sup>th</sup> century, with famous methods being developed by Dionisio Aguado, Mateo Carcassi and Ferdinando Carulli. Jazz guitar Instructional literature, on the other hand, has for the most part been produced after the first half of the twentieth century. Although it has existed for longer as a tradition, the classical guitar only gained wide acceptance and vast popularity in the classical world in the twentieth century - in no small part thanks to the work of guitarists such as Andres Segovia and Regino Sainz de la Maza, who contributed enormously to the expansion of its repertoire through several commissions and their own arrangements, as well as through the development of a more refined technical and aesthetic approach. An example of the acceptance of the instrument in the classical concert hall is Joaquin Rodrigo's famous 'Concierto de Aranjuez' from 1939— a guitar concerto written for De la Maza which was one of the most popular classical music concertos of the twentieth century.

In the following segment I will list and describe a series of examples of standard classical guitar instructional literature, ranging from the first half of the 19<sup>th</sup> century to the 21<sup>st</sup>, and including some of the most influential and quintessential methods. Thereafter, I will list those elements and content which are common between them and which can be considered to have become the standard information presented in the process of teaching how to play the classical guitar. After providing a short discussion on these conclusions, I will discuss a series of titles which are amongst a minority in that they break away in significant ways from the tendencies of the



common methods, providing guidance on aspects which are not usually covered, or different ways of looking at or approaching areas of knowledge.

## **Examples of the most common type of classical guitar method**

### **Dionisio Aguado – Complete Method for Guitar**



Dionisio Aguado – *Complete Guitar Method* (front cover of the Ricordi reprint from 1966). Image 32

This method from 1825 is one of the most traditional of all methods for the classical guitar. Aguado himself was one of the most recognised classical guitar players of his day, playing and composing during the early 19<sup>th</sup> century, and contributing in a major way to what became the original conception of the classical guitar as we still know it today and with the exact same tuning. “The guitar is an instrument which is yet not very well known. Who would say that amongst all the instruments used today, it is perhaps the best suited to create the illusion of a miniature orchestra, because of the similarities of its effects? This seems inconceivable at first sight, yet experience leaves no doubt about it” (Aguado, 1825).

The content of the book is organised in such a way as to provide the student with an understanding of the instrument’s nature, its possibilities, behaviour and how to best approach its use physically, before playing a note. The first eleven pages alone are

dedicated to describing these kinds of ideas. Aguado presents different chapters in this section including: *The idea that must be formed about the guitar*, *The character of the guitar*, *Denomination of some guitar parts*, *Conditions to play the guitar well*, *Conditions that are required for a good guitar*, *conditions related to the performer and the place where he will play*, amongst others.

Shortly after, specific guidance for posture and use of the right and left hand are introduced. This is then followed by an introduction to the chromatic and diatonic scales, before starting on several exercises designed for the development of the common right and left hand finger combinations which are essential for guitar repertoire .

Interestingly, although the vast majority of the book is dedicated to the development of the mechanical aspect of playing through exercises and studies, as well as to the concept of performing, at the very end the book briefly introduces the subject of understanding the instrument harmonically. This last chapter is titled *Ideas regarding the knowledge of the fingerboard of the guitar*. In this section, Aguado introduces the concept of intervals (dividing them into simple and compound), and how these can then be used to construct chords in their major, minor, dominant, and some extended types.

## Ferdinando Carulli – Complete Method for Guitar

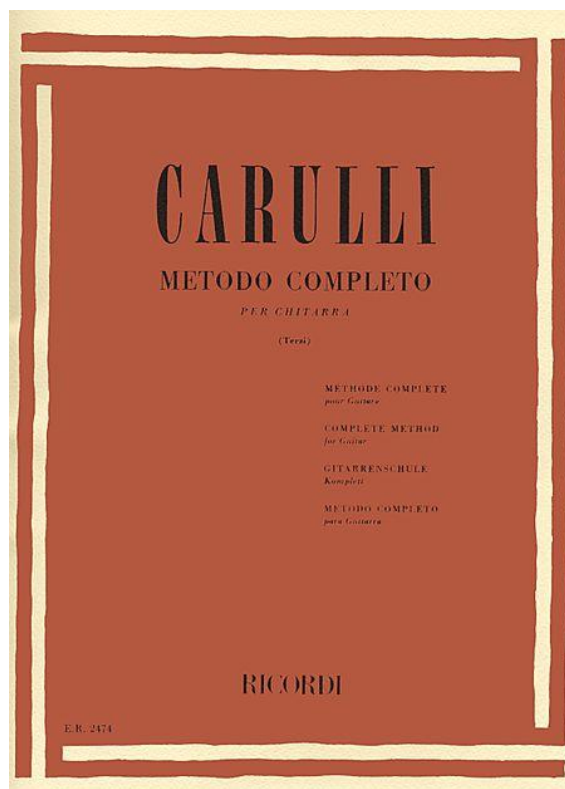

Ferdinando Carulli – *Complete Method for Guitar* (front cover of Ricordi reprint from 2012). Image 33

As with Aguado's book, this method is one of the most traditional for the classical guitar. Also one of the most popular and influential performers and teachers of the period of conception of the classical guitar as we still know it, Carulli originally published it in 1810. He later published an improved version of this method in 1842 (which is the one consulted here) after several years of further experience performing and teaching.

Similarly as with Aguado's, Carulli's method starts from the very basics of the nature of the instrument, the ideal posture that must be used, and the way in which the fingers must be utilized for the purpose of execution. Nonetheless, this particular

method also includes guidance as to how to read musical notation, including note values, rests, stave positions and clefs.

The entire rest of the method consists of teaching the student how to gradually develop the ability of the right and left hand fingers in a way that will allow the player to build a solid technical platform from which to approach further and more complicated repertoire. Interestingly, arpeggios and scales are introduced in order to be used as exercises, without their compositional and theoretical context being described. Examples can be found between page 11 and page 13, where several arpeggio-based exercises are presented, without any kind of explanation of the harmonic context or progression behind them. The only concept related to harmonic understanding in the book is the introduction of intervals, or “double tones” (page 36), and how they appear and can be accessed on the guitar, which is then explored through different exercises including thirds, sixths, octaves and tenths.

### **Charles Duncan – A Modern Approach to Classical Guitar**

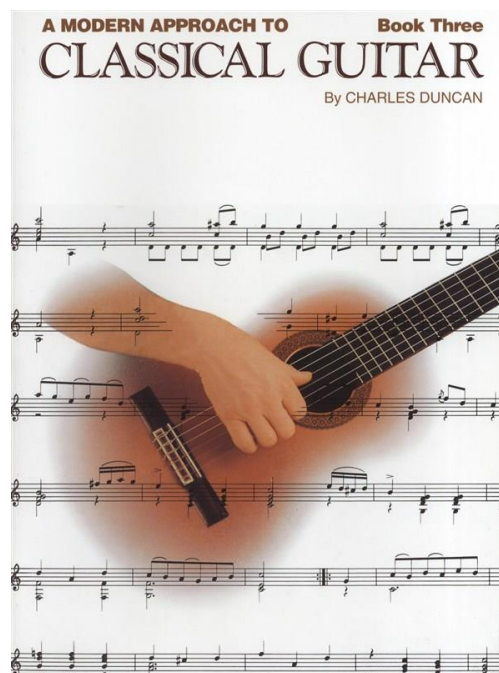

Charles Duncan – *A Modern Approach to Classical Guitar* (front cover). Image 34

In this modern method originally published in 1983, Charles Duncan provides guidance into the world of the classical guitar and its traditional technique whilst including fresh ideas from the point of view of repertoire. The pieces which are incorporated as part of the learning material include classical arrangements of folk songs (such as 'Greensleeves', 'Celtic Ballad' and 'Go Tell Aunt Rhody'), Christmas carols (such as 'Deck the Halls', 'Auld Lang Syne' and 'Joy to the World') and of other classical pieces not generally associated with the guitar (such as Beethoven's 'Für Elise' and Sibelius's 'Finlandia').

In its structure and priorities, however, the method closely relates to those consulted previously in this chapter by Carulli and Aguado, with the only significant difference being that it goes into more depth within the same general technical approaches. For example, Duncan dedicates the first 20 pages of the book solely to guiding the student towards understanding the way the hands, fingers, wrists, nails and sitting position should be used in order to play the instrument in the most efficient way, as well as providing guidance in the task of reading music.

Thereafter, repertoire is introduced in such a way that these principles are practiced, and further technical and musical knowledge can be developed, such as ties, accidentals, chord playing and right hand finger combinations. He organises progress in such a way as to include the notes found on each separate string gradually as the student moves through the repertoire.

It is interesting to see that, within the books consulted thus far (which are over a hundred years apart) the approach to the instrument and its study is essentially the same. The technical principles presented by these three books are virtually identical, with the only exception being that Duncan's book from 1983 provides extended explanation on some of the principles as well as providing guidance as far as nail length and rest and free strokes. These basic principles of technique, however, remain the same: the guitar resting on the left thigh, the back to be kept straight, the right hand fingers to play the higher strings, the right hand thumb to play bass strings and to be placed to the left of the fingers. But perhaps most importantly (as with the early 19<sup>th</sup> century books) the method starts by ensuring that the learner has a solid

foundation technically (with basically the same principles), and then gradually introduces repertoire to practice them, alongside the introduction of further technical principles.

### **Mario Rodriguez Arenas – The School of the Guitar (books one to seven)**



Mario Rodriguez Arenas – *The School of the Guitar* (front cover of the Ricordi reprint from 1987). Image 35

Rodriguez Arenas created his guide for learning the classical guitar dividing it into seven chapters. The method was published originally in the 1930s and, apart from providing Rodriguez Arenas's own material, relied also in no small part on the use of exercises and studies by some of the most influential guitar instructors for the guitar, such as Dionisio Aguado, Ferdinando Carulli and Francisco Tarrega. This happens throughout the different volumes.

The books contain mostly information on technique and its development through the use of studies. The author, however, does include something rather different to most other material of its kind in that it provides, comparatively, a very large amount of pieces to accompany the technical work and to allow the player to start building a repertoire alongside it in a more significant way than most.

As far as theoretical and compositional understanding are concerned, the book mostly excludes it, as is the case with all other books and methods consulted for this section. Occasionally, however, theoretical concepts are mentioned in relation to, and to introduce, particular techniques which will be taught – “Thirds are major or minor, diminished or augmented. The major third is comprised of two tones or five spaces, and the minor third of three semitones or four spaces. When they are taken on two strings the major third comprises two spaces and the minor third three, except when they are taken on the second and third string” (book 2, page 13).

### **Julio Sagreras – First guitar Lessons (Books one, two and three)**

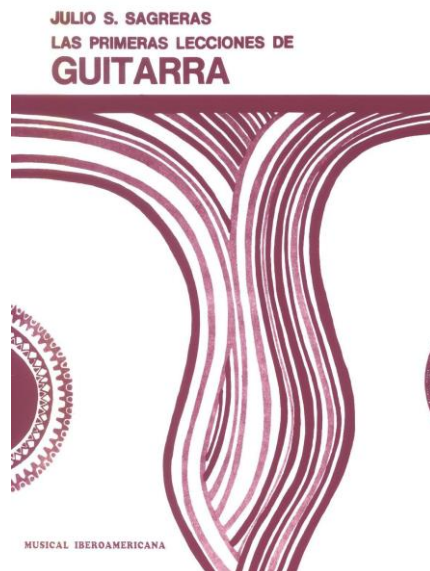

Julio Sagreras – *First Guitar Lessons* (front cover of the Musical Iberoamericana reprint from 1973). Image 36

In this three-part method, originally published in 1922 and more recently compiled into one book by Mel Bay publications, Argentinean guitarist Julio Sagreras provides his version of a comprehensive course for the classical guitar. Widely known and influential during his time, Sagreras was heavily influenced by (and knew personally) Miguel Llobet – possibly the most influential classical guitarist of the generation before Andres Segovia and Regino Sainz de la Maza. Indeed, some of the exercises in this book are based on his conversations with him and his approach to teaching beginners.

As far as the content of the book is concerned, it is typical of its tradition, basing itself on the acquisition of technical proficiency as the basis to playing the instrument properly. This can be seen in the first ten pages (divided in 36 short lessons) where the author gets the student to run through open strings with alternating right hand fingers in order to get accustomed to the correct general approach to pluck, as well as in the subsequent lessons in scales, arpeggio and chords. As far as the understanding of music from a theoretical or compositional/harmonic perspective, there is no guidance provided.

Interestingly, Sagreras uses very little text comparatively to most other methods. Naturally, the amount of regular text included in practical methods is rarely extensive, with the musical/graphic notation of ideas, exercises and pieces occupying the majority of the space. Nonetheless, in this book the verbal description of concepts is reduced to a minimum before presenting the corresponding practical workout. For example, on page 13, chords are introduced – “In this lesson chords are introduced for the first time. It is preferable that the student plays weekly (softly) at first, plucking a reduced amount of string with the tip of the fingers and making the movement towards the palm of the hand” (Sagraeras, 1922). Straight after this introduction, the scale exercises begin. The seeming lack of guidance on an introductory level with each new concept may be validated by the fact that the author does point out, from the beginning and throughout the book, that the guidance of a teacher is important for the use of the material “In the following lesson, the teacher will have to observe carefully whether the student adheres strictly to the indicated right-hand pattern. The



same care must be taken when observing the accentuation and emphasis of notes” (p. 20).

### Scott Tennant – Basic Classical Guitar Method (Book One)

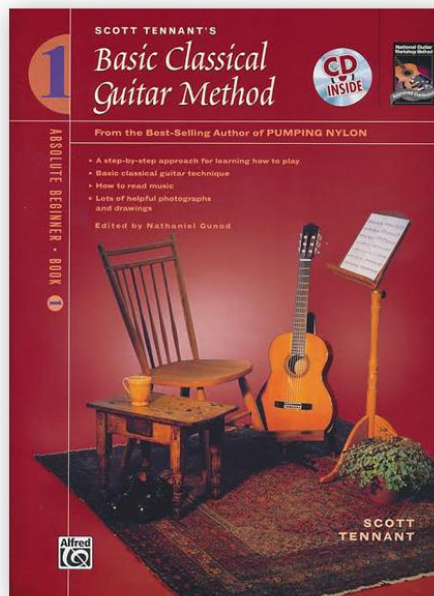

Scott Tenant – *Basic Classical guitar Method* (front cover). Image 37

Scott Tenant is an internationally respected classical guitarist and teacher. As an author, he is renowned for his classical guitar book '*Pumping Nylon*' – a book dedicated exclusively to technique development which has also been consulted and will be discussed later in this chapter. This particular title is, as with others in this segment, Tenant's attempt at creating a method that will teach the classical guitar from the very beginning. In fact, he decides to emphasize the fact that no previous experience of playing is necessary at all by indicating in the front cover that it is designed for the "complete beginner".

After looking at this book, it is easy to see its relationship with the previous three titles consulted. As with Aguado, Carulli and Duncan, Tennant's priority is to build a strong technical foundation based on all the right habits from the outset "If you follow the lessons in the series, and practice wisely and regularly, you will develop a solid foundation and positive, good habits that will give you all the skills you will ever need for a lifetime of enjoyment playing the classical guitar" (Tennant, 2003, p. 4).

In order to achieve this, he relies primarily on the same traditional principles that originated in the 19<sup>th</sup> century as far as posture and use of the fingers, nails and hands. As with Duncan's before, this modern method elaborates further into the same principles, but also presents information in a more contemporary and visual way, with additions such as '*Scott Says*' segments, providing quick tips for achieving certain tasks, as well as modern pictures and drawings to make material more entertaining and appealing.

It is worth mentioning that in the following accompanying books to this series, Tennant occasionally and briefly mentions simple aspects of theory, particularly those which most closely relate to learning repertoire, such as the understanding of key signatures as related to major scales "The major scale is one of the most important scales. It is composed of seven different pitches arranged as follows: whole-whole-half-whole-whole-whole-half. It ends on the same note on which it began, which we call the tonic, to create an eight-note scale". (Tennant, 2003, p. 35). However simplistic these concepts seem, they seem worth mentioning given their rarity amongst classical guitar methods.

## Christopher Parkening - Christopher Parkening Guitar Method

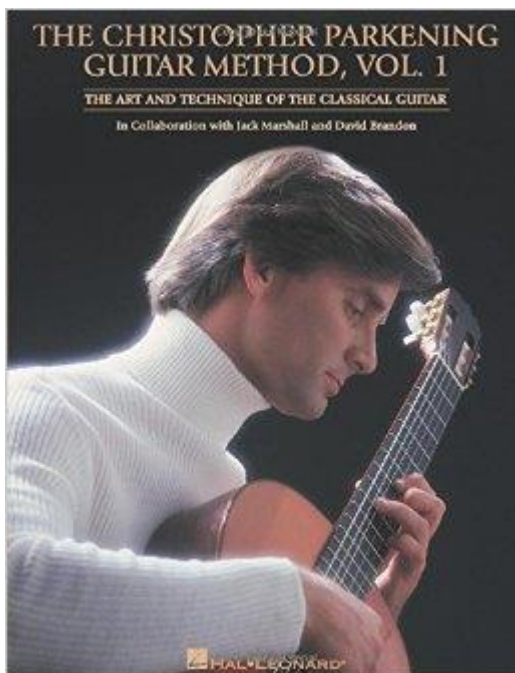

Christopher Parkening – *Christopher Parkening Guitar Method* (front cover).

Image 38

As a performer, Christopher Parkening became one of the most distinguished classical guitarists in the world during the 1960's and 70's, gaining the admiration of the likes of Andres Segovia, who regarded him as “One of the best guitarists in the world” (Stevenson, 2010).

Since the late 70's and until today, Parkening has dedicated a lot of his time to teaching the guitar, eventually making it its full-time occupation. In this method, the approach is to get the learner to understand the basics of technique and posture, as well as a basic knowledge of the instrument, how to tune it and its parts, before doing any playing. Until page 20, Parkening focuses on these topics and specifically technique concerning the right/plucking hand, before introducing a series of rhythm studies, which are then followed by a similar approach to the left hand technique.

In this regard, the method closely follows the same approach as those discussed previously. On pages 66 to 68, however, Parkening diverts momentarily from this trend, and introduces concepts related to music theory, namely scales, intervals, key signatures, the circle of 5ths, relative minors, chords and transposition. “In studying the classical guitar, it is wise to understand the basic mechanics of music theory. The very simple material presented here will start you on the path to grasping the systematic principles of music and will be very helpful to you in the studies to follow” (Parkening, 1972, 66). In the following two pages, Parkening provides a very basic description of the concepts mentioned above, before continuing with studies designed for right and left hand technical practice.

Within the classical methods consulted so far, we can see how it seems unusual to find any guidance on music theory. Here we find an example of a book that does, which is nonetheless two pages long and very basic. It is interesting to observe the contrast with the jazz guitar methods consulted, where the opposite occurs – an in-depth study of harmony of the instrument (and its application to improvisation) constitutes the majority, or all, of the information, and technique is a very occasional, short, extra addition. Like with technique in most jazz methods that include it, the short section on music theory here appears in the second half of the book.

## Nathaniel Gunod – Classical Guitar for Beginners

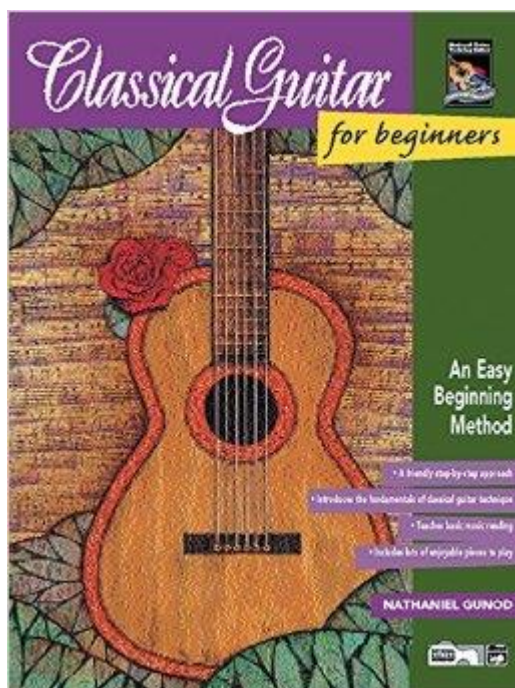

Nathaniel Gunod – *Classical guitar for Beginners* (front cover). Image 39

This book aims to guide the complete beginner on how to learn to play the classical guitar. As with all the books presented in this section so far, the priority is to create a strong technical foundation in the student, avoiding bad habits that will later limit the player and require time to replace with good ones. Indeed Chapter Two of the method is called “Start Making Music!” which appears after a previous 12 pages dedicated solely to the mentioned technical aspects. Even within this second chapter, most of the material presented is designed as a vehicle to continue absorbing further technical principles such as right and left hand positions, free strokes, the use of the left hand thumb, and building an awareness of some of the notes on specific strings.

Gunod’s method, however, does contribute in the area of repertoire, where the vast majority of methods usually start by teaching the learner music that is often not appealing and not related to the music that inspired them to play in the first place. Here he introduces the beginner student to studies in the style of famous composers,

as well as actual simplified transcriptions from famous composers, such as Tarrega and Bach.

Overall, his guidance is clear and detailed, providing simple, but important and encouraging tips that can be of significant help for learners “Remember to prepare, repeat and review. Play very slowly and practice very small portions at first and you will be sounding great soon. Master one piece before going on to the next” (Gunod,1996 , p. 26). Guidance on theory and harmony is, however, not part of the content of the book.

### **Emilio Pujol – A Theoretical Practical Method for the Guitar**

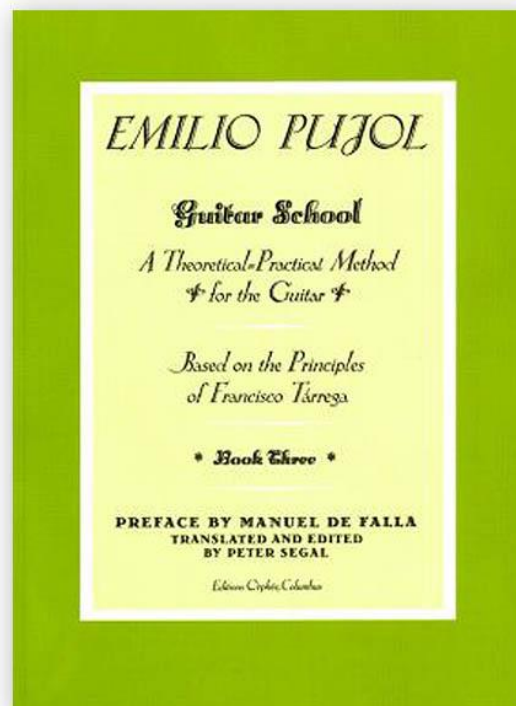

Emilio Pujol – *A Theoretical Practical Method for the Guitar* (front cover of Orpheo reprint from 1991) Image 40

Emilio Pujol has been largely credited with disseminating the teachings and techniques of Francisco Tarrega, his teacher and probably the most influential classical guitarist of the 19<sup>th</sup> century, also responsible for composing what are still today some of the most well known pieces in the instrument's repertoire, such as *Recuerdos de La Alhambra*, *Lagrima* and *Capricho Arabe*, amongst others. Pujol achieved this, in no small part, through this publication, dedicated to that goal and to the contemporary application of Tarrega's technique.

Published originally in 1933, this book originated in a time prior to that in which most other publications consulted in this section did. In this sense, the book did not serve as much as another player's/teacher's take on the already established principles and ways of learning the instrument, but instead as a way of shedding light on one of history's most highly regarded guitar performer's approach to the instrument, which was up to that date known at a much more superficial level. "With the dear and illustrious master (Tarrega) I trained. He guided my steps from the beginnings of this century until the later years of his life" (Pujol, 1933, p. 14).

As can perhaps be expected, the newer generation of methods and books (such as some of those consulted here) is a consequence of the literature that came before it. Here are presented all of the basic concepts that modern authors most frequently present in their material – posture, right hand and left hand use, quality of sound, the approach to stroking the strings, etc. One significant difference worth mentioning is not so much in the areas of study, but the depth of the analysis of some of these areas. Unlike some recent methods, Pujol makes more elaborate and extended analysis of many principles, often touching on the physical considerations of matters regarding the instrument and its behaviour "The differences between the sounds of the strings come from the number of vibrations produced by second, and these differ according to the weight, thickness, length and tension of the string" (p. 26). In fact this book (the first of four volumes) contains a significant amount more regular text than musical notation. In this regard, Pujol's aim is to get the reader to thoroughly understand the guitar and its behaviour as an apparatus, before starting to play music. Indeed this book works as well as a composer's guide to the instrument and

its possibilities, as it does to a new student. As it's expected from a book that had a significant influence on the newer generation of methods, the overwhelming main focus of these volumes is to provide an in-depth understanding of the instrument's technique, musicality and sound possibilities, but not a study of music theory and harmony and how these apply to the guitar.

**Frederic Hand – Classical Guitar technique and Musicianship (instructional video)**

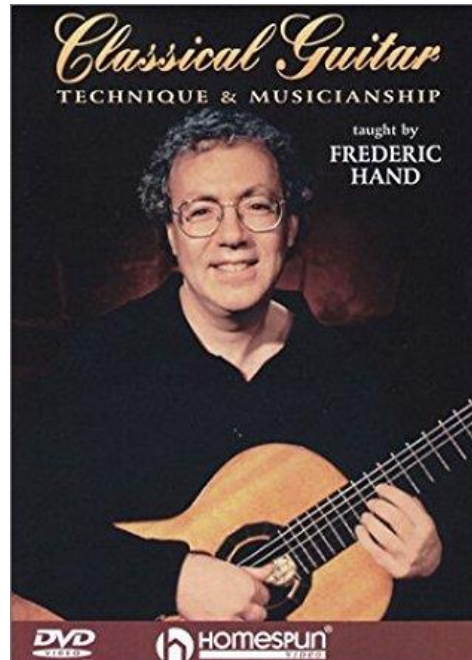

Frederic Hand – *Classical Guitar Technique and Musicianship* (front cover).

Image 41

In this instructional video, acclaimed guitarist Frederic Hand describes all the basic principles of good classical guitar technique in a summarised and easy-to-follow way. Starting with finding the right general posture through always aiming for a fully



relaxed state, he then follows on to the way in which the right hand fingernails are shaped and polished, shortly after providing guidance on the basic right hand strokes and finger combinations.

Later Hand explains the difference between the application of chords as block sounds and as arpeggios, demonstrating the necessary techniques for both, and giving advice on the development of these techniques. Overall, the video focuses on efficiency of movement for playing “The definition of good technique is the elimination of wasted motion” (Hand, 2000).

After the first half of the video, hand discusses the angle of approach of the left hand fingers and thumb in order to achieve a clear sound, as well as the ideal angle of the left hand as a whole in order to produce good sound and avoid unnecessary tension and use of strength. This then leads to the application of bars (or *barre*) positions for the left hand and their use in repertoire, as well as slurs and legato.

Hand’s video concludes with guidance on learning repertoire, advising students to learn pieces gradually by mastering segments and practicing slowly “The muscles have their own rate of learning, and it is very different from what you would like it to be. The fact is that we don’t know what that rate should be, so we can’t impose an artificial rate on it” (ibid). In essence, the content and approach presented in this video is a visual take on that which that which text books of its period tend to take.

*Based on the evidence gathered, we can then conclude that the standard information presented within teaching material for the classical guitar is the following:*

- Technical approach to plucking the strings with the fingers
- How to produce different tones and timbres from the instrument
- Technical approach to fingering the strings on the fretboard
- How to hold the instrument and what posture to adopt
- Exercises specifically created to develop and improve finger independence, speed and stretching on the left hand.
- Exercises specifically created to improve and develop finger independence and speed of plucking on the right hand.

- Developing a repertoire gradually as you learn. Slowly increasing the level of complexity as the technical ability becomes more advanced.

### **Consequences of these priorities**

Through the above examination of several (old and new) standard methods for the classical guitar, we can see how, above all (and most often exclusively) the main goal of the material is that of teaching a standard, well defined, technique, its development through exercise and studies, and its utilisation in repertoire.

There is almost no guidance on principles for the construction of music, harmony, composition and, in general, of how the theory of music works (beyond that needed for reading music).

In this sense it is perhaps not surprising that we don't often see classical players venturing out of their stylistic confinements to interact with other kinds of musicians and guitarists, unless it is a classically-approached arrangement or performance of a piece of music originally conceived in a different style.

### **Fresh approaches**

As with jazz literature, there is a series (although a much smaller number) of examples of classical guitar instructional material which approaches the instrument and its techniques from a slightly different angle. Following are some examples which I have found particularly interesting:

## David Oakes – Classical and Fingerstyle Guitar Techniques

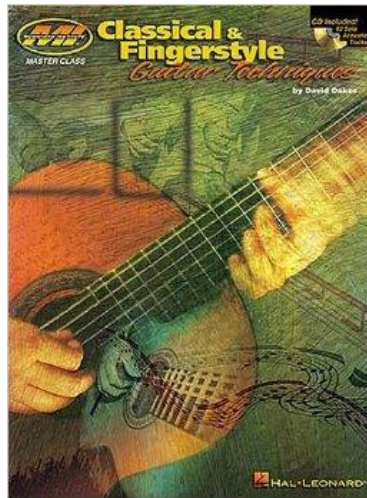

David Oakes – *Classical and Fingerstyle Guitar Techniques* (front cover). Image 42

As can be read in the *Practice Based Research* section of this thesis, this was in fact one of the books which I personally (as a guitarist coming from the jazz style) used to learn to play the classical guitar and acquire its technique. David Oakes is also one of the guitarists I interviewed as part of this project. This book is particularly aimed at people who can already play the guitar at a high level, but have not necessarily played in the classical style. For this reason it seemed perfect for my personal situation and was indeed very effective.

It contains a compilation of material extracted from some of the most traditional and established methods in the history of the instrument - such as the methods of Dionisio Aguado and Ferdinando Carulli, as well as music by other classical composers such as Bach, together with Oakes' own technical exercises for the development of certain important techniques - such as two and three finger tremolo, finger independence, legato, and even flamenco-style rasgueado. In this respect the book gets away from the tradition in that it incorporates certain elements outside of the strict classical musical tradition. I believe that in doing so, it not only is able to introduce elements which allow certain pieces to sound more authentic (such as rasgueado can make Spanish classical guitar music –which is undoubtedly heavily influenced by flamenco- sound more authentic) but also opens the student up to

other genres of music which can indeed be compatible with the fingerstyle guitar. For example Oakes includes occasional blues-based exercises which expose the learner to that style, whilst simultaneously developing relevant techniques for classical playing.

### **Eduardo Fernandez – Technique, Mechanism, Learning**

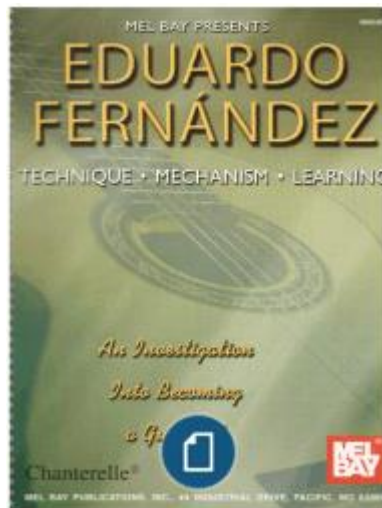

Eduardo Fernandez- *Technique, Mechanism, Learning* (front cover). Image 43

Uruguayan guitarist Eduardo Fernandez has for many years been one of the most admired classical guitarists in the world. His technique is exceptionally effective and effortless and his musicality of the highest standard. As a guitarist and student, Fernandez has been deeply influenced by fellow Uruguayan classical guitar virtuoso Abel Carlevaro, who in previous decades had been at the forefront of presenting innovative approaches to learning and mastering the classical guitar technically (with his instructional books – such as *Abel Carlevaro Guitar Masterclass* and *Abel Carlevaro Microestudios*, as well as instructional videos- being very influential in the field). Here he takes Carlevaro’s teachings, coupled with his own extensive experience in performance and teaching, to present an innovative approach to the mastery of the instrument.

The striking aspect of the book is the fact that it provides in depth philosophical, motivational and logical guidance about how to mentally look at and approach the

work on the instrument, as well as giving the practical information and respective exercises. For instance, Fernandez sees the way many students are encouraged to learn the instrument as a repetitive and mechanical system, with students often “working on the passage to be studied until the passage “tires” of fending off the student’s efforts and gives up” (p. 7). He analyses the way in which we as humans routinely tend to look at, and approach, things that we want to master:

“It is perhaps a trait of human nature that when attempting to master a work one prefers a slow and monotonous path which does not demand much mental effort, in preference to a steep one dealing directly with the objective. The former, in my opinion is based on mechanical and fundamentally inhuman repetition. The tendency to follow the line of least resistance is understandable, but we should try to re-define the very idea of resistance and look for that narrow line along a more exciting path. In my experience, a far more direct route than that we usually follow does really exist. It is the intention of this book to make a detailed presentation of the constituent parts of this Via Non Dolorosa (or pain-free way)” (Fernandez, 2001, p. 7).

As far as instructional books are concerned, what Fernandez refers to as a repetitive and mechanical system seems certainly to be common practice not only within the classical guitar genre (although it is certainly extensively applied in that style) but with others as well, such as jazz, blues and pop. In my experience of learning the instrument in popular styles, jazz and classical, I have used several books (many of which I refer to in the *phenomenological analysis of the candidate’s own experience* section of this thesis), as well as seeking lessons and advice from several players, and sharing opinions and thoughts with many colleagues. I had certainly been given precious advice in areas outside the execution of the instrument, such as the mental states which facilitate success in performance or how to organize practice in strategic ways in order to maximize results. However, I had never been provided with an equivalent analysis of the possibilities that exist for the purpose of mastering the instrument from a psychological, philosophical and logical point of view.

## Martha Masters – Reaching the Next Level-A Method for the Experienced Classical Guitarist

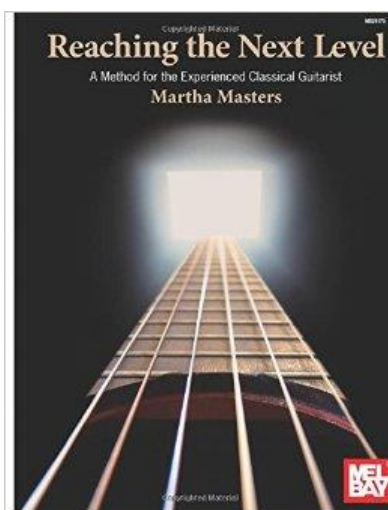

Martha Masters- *Reaching the Next Level* (front cover). Image 44

In a similar vein to Eduardo Fernandez's *Technique, Mechanism, Learning*, Masters here presents a series of lessons dedicated to mastering the instrument beyond the mechanics of playing it. As the title suggests, the book is intended for the experienced player. However, the book is not as contrastingly different to tradition as Fernandez's in its views of how to maximize the potential of the energy and time spent on the instrument.

Nonetheless, the book does present extremely valuable information to advanced players in ways that I had not seen before. Very often in common learning environments, classical guitarists do not spend much time thinking about aspects of music such as critical listening, developing concentration, breathing, listening to interpreters, networking, anxiety and mental states or defining success. These are some of the infrequent topics which this book brings to the surface and analyses thoroughly, and that (in my experience and that of colleagues) certainly can have a big impact on the overall quality of a musician's output.

Talking about critical listening, Masters suggests listening attentively to other performers and trying to be as specific and analytical as possible to understand why

we liked or did not like certain things that they have done. Similarly, as a way to refine our own performances, she encourages the student to record him/herself playing, carefully listening to the recording and writing down anything they hear that they might want to improve. The combination of psychological, strategic and technical advice that this book provides, although not radically different in its view, brings together valuable information about different –frequently separate- aspects of being a guitarist.

### **Goharb Vardanyan – Complete Warm-Up for Classical Guitar**

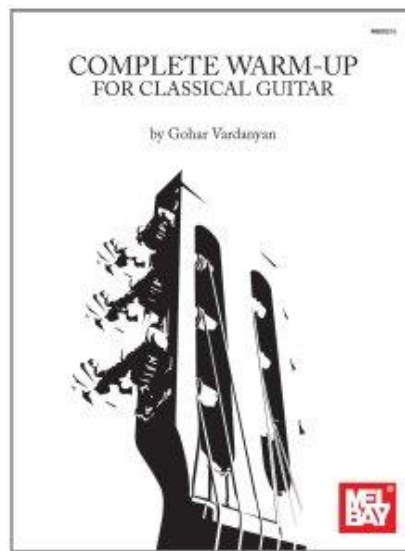

Goharb Vardanyan- *Complete Warm-up for Classical Guitar* (front cover). Image 45

Although this particular book does not present ground breaking information regarding how to approach the guitar from a technical or ideological point of view, the fact that it is a whole publication exclusively dedicated to warming up makes it stand out from the vast majority of books dedicated to this style.

Vardanyan presents a series of exercises divided into four main categories: arpeggios, scales, tremolo and slurs. He suggests at least five minutes of work on each of these areas for each practice session, building up to a twenty minute warm up, whilst saying that a full 60 min warm up can be achieved through use of the whole book. Some of the material is composed of selections from universal guitar

training repertoire (such as routines by Mauro Giuliani), whilst some are by the author himself. Additionally, Vardanyan indicates that the book can also be used as a way to improve and refine or technical skills on the instrument.

**Ricardo Iznaola - Summa Kitharologica, Volume 1. The Physiology of Guitar Playing: Functional Anatomy and Physiomechanics**

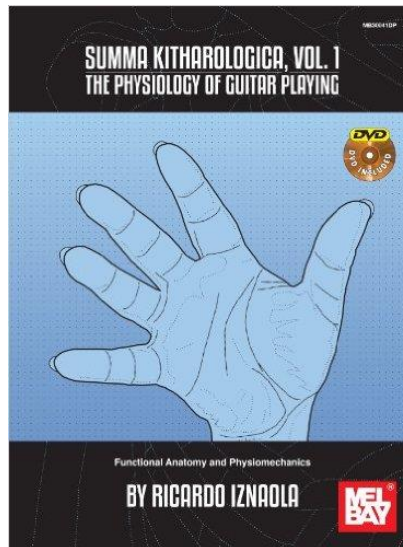

Ricardo Iznaola – *Summa Kitharologica, Volume 1* (front cover). Image 46

When I first discovered this book I was pleasantly surprised to find something significantly refreshing amongst guitar literature in general. Unlike the vast majority of publications in any genre, this book provides not only ways to play and approach the instrument technically, but digs deeply into the reasons why, from a physiological and scientific point of view, these techniques work. For example, Iznaola explains the reasoning behind the thumb's greater mobility, when compared to the other digits in the hand, referring to physiological terminology "The thumb's muscular mechanism is the most independent and versatile of the digits in the hand, thanks to the interaction of the extrinsic longer muscles lying in the forearm with the smaller intrinsic , located in the thenar eminence" (p. 40). He also includes several images (as well as a DVD) in order to make concepts and their application more accessible to the student.

In the first chapter, on the limbs and general physiology, he explains the use of the musculoskeletal system when paying the guitar in two types of use: 1) for providing



stability and support, and 2) for movements whose coordination is the aim of technical training (actual execution). This is then analysed further to explain which parts of the system are used for which task. The axial skeleton (skull, spinal column, sternum and rib cage) in conjunction with the lower extremities (part of the appendicular skeleton) are responsible for stability; whilst the upper limbs (the remaining part of the appendicular skeleton) is responsible for the instrument's execution. With this particular use of the musculoskeletal system, the upper limbs do not take part in the stability task and are completely free to be used exclusively for execution.

The book is divided into three main chapters, including chapters dedicated to general physiology and the upper limb, the right hand and the left hand. From my experience, its overall approach is certainly innovative. I personally came across the book during the later years of my research, and am looking forward to working further with it and incorporating its suggestions into my own playing and teaching in the upcoming months and years.

### **Ricardo Iznaola - On Practicing-A Manual for Students of Guitar Performance**

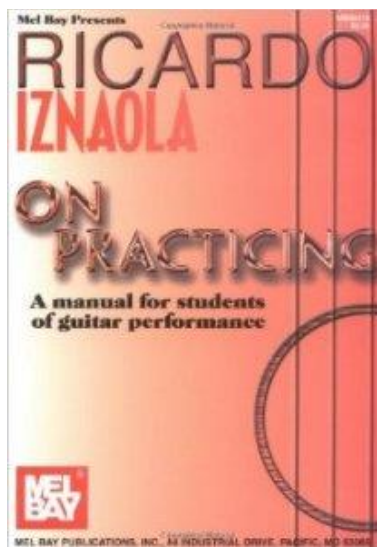

Ricardo Iznaola – *On Practicing* (front cover). Image 47

As the title suggests, this is a book dedicated specifically to providing guidance on practicing the instrument. Defining the ultimate goal of good practice as “successful public performance”(p. 3) the author of *Summa Kitharologica, Volume 1. The Physiology of Guitar Playing: Functional Anatomy and Physiomechanics (2013)*, here guides the reader through in-depth ideological as well as technical information on how to strategically approach our practice.

Interestingly, one of the important pieces of advice given by Iznaola is to be detached from the music we are practicing from an emotional perspective. He suggests that in doing so, we are in a much better position to succeed from an intellectual perspective, being able to analyse material, and our results, more objectively. He in fact suggests that, during practice, we adopt a scientific approach and imagine ourselves in a lab. I find this particular approach extremely interesting. After all, musicians are often perceived as more associated with the arts and perhaps even with romanticism than with science.

However, in my own experience I have indeed felt at times emotionally affected, not only by the music itself but, perhaps most importantly, by the unavoidable good and bad results that are revealed after a certain amount of work in any particular task. In this sense, I think the overall intention of this book to create effective practice habits from a very rational and scientific approach (encouraging avoiding the opposite) can certainly be useful for any guitarist, in or outside of the classical genre.

## Anthony Glise - Classical Guitar Pedagogy: A Handbook for Teachers

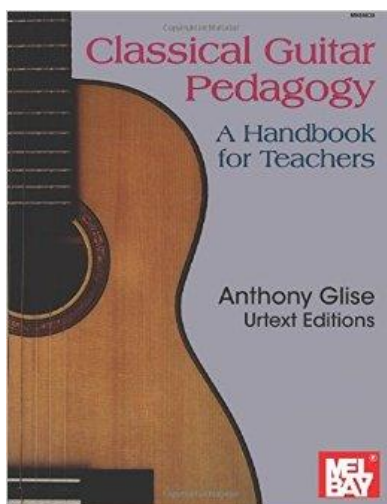

Anthony Glise- *Classical Guitar Pedagogy* (front cover). Image 48

Teaching the guitar is an activity which is certainly widely practiced. As a teacher myself I know that mastering the instrument itself and being a good teacher are related, but not equivalent, tasks. From my own experience, the best players are not by implication the best teachers (although of course, some fantastic players are also fantastic teachers). This book is the best I have seen as far as books for training teachers go. I decided to include it in this list because, apart from training the teacher, the book aims to explain the logic of why certain techniques and established approaches exist (which is something that many other books do not include) so that the teacher can explain this logical reasoning to the student.

The book is subdivided into three other sub-books which deal with the subjects of: Principles of Technique, Principles of Pedagogy and Musicianship. These chapters include information regarding exercises for the student, practicing, preparing for performances, teaching how to memorize and coaching. Also, in the Musicianship chapter, the book gives guidance on how to assess students' performances aesthetically, including suggesting in aspects of dynamics, timbre, articulations, phrasing, orchestration (as viewed on the guitar as an instrument of huge possibilities in timbre and tone colour), as well as a section on Schenkerian analysis for interpretation.

## Final thoughts on instructional literature

For both the jazz and classical guitar, it is undeniable that the amount of instructional material available today is vast and much greater than ever before. Literature is also now accompanied by the great emergence of video –based tuition (which has also been mentioned and covered within this review). In both jazz and classical cases, the quality of all material reviewed is generally very high, and gives detailed and logical guidance to students in the areas that they set out to do so.

It is intriguing to see, however, that amongst the books researched for this project in the jazz style there seems to be very little information telling the student how to actually get started on the instrument. This is one of the most interesting facts discovered through this research about jazz guitar literature, and instructional material in general. Jazz books teach the student to play the style whilst expecting him or her to either already have the coordination and motor skills necessary to operate the instrument or to find them elsewhere.

In contrast, ~~most~~ all classical guitar methods consulted teach the student how to get the instrument to work properly first before teaching him/her how to play any music on it. The technical priority is there from the very first pages of classical instructional books, ~~while~~ just as the priority to gain the skills necessary for improvisation and spontaneous creation is there in jazz methods from the very start also, to the point that there is usually little in-depth information on anything else.

Likewise, there is almost no information related to the structure of music, composition or harmony within classical books. In essence, they teach the player to effectively develop technique and reading skills, and learn pieces, without any desire to get them to understand what the principles used in the creation of those pieces where, not even for the purpose of good interpretation.

Also interesting is the fact that the majority of books included here in the *Fresh Approaches* sections for each style (where unconventional methods are the focus) do not deal with these gaps. They do provide fresh ideas, but often in various different

areas and, as a group, do not constitute a clear attempt to make up for this lack of guidance on the mentioned aspects of music in each style.

Nonetheless, it is also clear that the fact that each of these styles and their players/authors have spent such vast amounts of energy developing a deep, and academic, understanding of their stylistic requirements means that the level of knowledge of technique and harmony as applied to the guitar is today higher than ever before. It seems logical to me personally, as a musician, teacher and researcher, that these two (most established academic musical styles) should then look at each other in order to further advance their own understanding of their instrument in aspects that are, in my opinion, integral to music making and actually non-stylistic in their essence. In other words, I believe that it is not an opportunity for fusion, or influence, between styles (though that can be achieved and has been the focus of occasional experiments) in terms of sound and aesthetics, but an opportunity for classical guitarists to make further advances in **classical music**, and for jazz guitarists to make further advances in **jazz music**, simply because they will be able to understand how the instrument as a whole functions at a deeper level. The term *further-advance* is essential when discussing these possibilities, as the intention is not to find a way to improve the music and stylistic approaches of the past, but to influence that of the future based on a deeper understanding of the instrument as a whole.

## **Analysis of interviews**

### **The reason for conducting interviews**

My curiosity and desire to obtain information that truthfully represented the current relationship between these genres led me to think of different ways by which I could obtain evidence. I knew that literature research, a reflective analysis on my own experience in the styles and research into other forms of instructional material (such as video) would all be necessary areas to cover. However, the idea of interviewing guitarists came to me partly as a way to actively involve players themselves and their opinions into this work. I realized that to discover what is common practice on the guitar, one of the best ways was to ask current professionals in the field. I also liked the idea of involving local musicians in the research and, in this way, to ensure that the Manchester and the UK guitar community played an integral part in my research. It is important to add, however, that a number of musicians from outside the UK were also interviewed, in order to make the evidence diverse and avoid representing only one specific geographical region.

The interviews would also allow me to dig deeper into the current relationship between the classical and jazz guitar genres. Finally, I hoped to arrive at more concrete ideas as to whether guitar players themselves think that the communication between their styles could actually be improved and, if so, how that could be done. I have approached the questions and analysis of these styles with interviewees from a very open perspective, not focusing on any specific sub-genres or deep technicalities of either jazz or classical guitar music, instead considering the styles as a whole.

### **The process of selection of interviewees**

During the course of my research I interviewed 20 guitarists. I selected individuals who dedicate themselves exclusively to the jazz or the classical guitar, and a small

number who have taken the challenge to do both. Amongst these, some prioritize one of the styles over the other whilst still taking both very seriously. However, an even smaller minority actually dedicate themselves equally to both. In general, I tried to contact several accomplished guitarists (including high profile international performers, as well as local professionals and students of the highest level) explaining my project to them and asking them whether they would be able to participate in an interview either in person, through video chat, or via email.

For the vast majority of the individuals interviewed their current professional life, in one way or another, revolves completely around the guitar. For a very small minority, the guitar was their main instrument in the past, and they now prioritize other areas of music, whilst still playing the instrument. It is also a great pleasure to be able to include amongst the interviewees some individuals who are at the very forefront of their field at an international level, such as Martin Taylor in the jazz genre, and Craig Ogden in the classical genre.

All of the guitarists involved showed a real interest in the subject of the interview, and their passion for their instrument and music became evident to me as most of these meetings spontaneously developed into much longer conversations about the subject than was initially planned.

### **New questions emerge**

It is important to mention that I planned and conducted these interviews simultaneously with conducting the rest of the research (with some of the interviews taking place during the first few months of this project). Therefore, I designed the questions according to the general areas of interest within the subject that I considered useful and relevant at the time. As I write this now, in the final months of this project - now with a much further-developed understanding based on the last two to three years of research- a series of new questions arise which I think would help me delve deeper into the subject. However, I also understand that the emergence of new questions and areas of interest is part of the nature of research and the scientific

approach itself. Nonetheless, the questions asked in these interviews have provided me with a good picture of the general vision and understanding that guitarists in both of these genres tend to have about the other, helping me to draw conclusions and originate ideas about how their relationship could perhaps become more beneficial for both.

Finally, as a guitarist and researcher my intention is to continue investigating this area actively and indefinitely, deepening my understanding of it and how I can help to advance and enrich its extant body of knowledge.

### **The questions/areas of conversation**

During the interviews, I introduced the following areas of conversation with all the interviewees (depending on the way the interviews developed, I also asked occasional additional questions that I considered beneficial to my understanding of the subject). I created the questions with the help of my supervisor, making sure that the main overall areas of interest regarding the research were covered. Broadly speaking, these included learning about what and how much players knew about each other's styles, the main characteristics of their journey as learners in their style, and what their thoughts are on the relationship between the two genres. Following is a more detailed analysis behind the development of each question:

#### **1- How did you start/what has been your general process of development as a guitarist?**

The purpose of this question was to see whether there were any main differences between the ways in which classical and jazz guitarists tend to start on their instrument, and what kind of learning methodologies and stages they go through as they make progress. This could contribute to understanding why they eventually developed certain views and ideologies as professional musicians, as well as why they approach the instrument in particular ways technically.



**2- Would you change/do anything differently, if you could go back, about the way in which you have learned and the things you have practiced?**

I wanted to see whether there were any players who mentioned particular aspects about music that they feel were lacking in their education as guitarists in their genre. I hoped to see whether they mentioned aspects of music which are covered in the musical education of guitarists in the other style.

**3- Have you ever come in contact with the classical/jazz (as appropriate) school of playing? What do you know about it?**

This question would allow me to find out to what extent jazz and classical guitarists have actually worked together, and whether they have any experience of playing each other's styles, contributing to finding out what the general amount of communication is between the styles.

**4- Between jazz and classical, which of the two styles do you think is more demanding and why?**

As a player who has attempted both styles at a high level for many years, I have a personal view of this question based on my experience. I wanted to see whether other players who I interviewed who are also advanced in both styles (a minority of the interviewees) share the same opinion. I also wanted to see whether these opinions differed to those given by players who dedicate to one of the two genres exclusively, in order to spot any potential areas where there may be a lack of awareness.

**5- Do you think there is currently good communication between the classical and jazz genre? If not, how could we improve it?**

Talking with players about this gave me a chance to see whether they are actually satisfied with the way the two styles currently see each other, or whether they feel that a change would be beneficial.

**6- Do you think it is important for classical players to understand the harmonic and compositional components of the music that they play?**

An understanding of harmony is one of the main areas of knowledge required to play jazz. I wanted to see to what extent jazz players feel that classical players should know about harmony, and also what the opinion was among classical guitarists themselves, in order to highlight any differences in musical vision and ideologies.

**7- Do you think it is possible to play both styles at a high level?**

Finally, this question helped me to go into more depth with regard to discovering how much players know about the demands and difficulties of each other's genres, based on the amount of work that they consider necessary to reach a high level in each other's styles.

In the following section I will give an overall summary of the information provided by interviewees, dividing it into two categories:

- Answers from classical players
- Answers from jazz players

It is worth mentioning that, at times, players provided answers to certain questions before these were formally asked, as occasionally their answers extended into relevant conversations about the subject. For this reason, some quotes included within the information about a specific question might appear on the interview audio/text at a different point than during the answer to that specific question. Likewise, when a question has already been appropriately answered before it was asked, I might not have later again asked the question in order to avoid repetition, making more time for other questions and conversation relevant to the subject.

## **Question 1 – How did you start/what has been your general process of development as a guitarist?**

### *Jazz interviews*

The majority of jazz players interviewed had a start on the instrument which was mostly intuitive. Self-tuition in rock, blues, popular and folk styles is a common trend in the early stages. A significant minority, however, had lessons from the very start but, interestingly, none of them in the jazz genre. Instead these lessons were in either another style of popular music or (in the case of Jim Faulkner) classical guitar. In his case, however, this was due to an arrangement made by his father based on the teacher he was able to find, as Jim was actually mainly interested in rock music at that point. Paul Cusick (2015) says “I started playing the guitar around eleven years old. I think I had a teacher from 16 years old onwards. I remember a lot of things were highlighted – problems, etc. I think my steepest learning curve ever was in that period. He was a really good tutor and got me into a lot of good habits”.

There is an interesting thread in this area which is that, although lessons are involved in the learning process of most interviewees at some point or another, most jazz players’ lessons are something that they access later in their development, rather than as the gateway to playing jazz itself. About the electric/jazz guitar and the way it can be approached John Harper (2014) says “Jazz (guitar) allows for a great deal more leeway or find-your-own-way as far as technical approach”.

In general, there is a lot more individuality in the way that the different jazz players have approached their learning. Although a good amount of the information which they have learned is, in many ways, ultimately the same (as far as the theory and the skills required in order to play jazz and improvise), they have created multiple different paths as far as how to discover and learn much of that information. From my own experience of learning jazz, I can easily relate to that. I started learning jazz after being inspired by my guitar tutor at college, who took us from playing mostly blues lines and strumming chord shapes, to understanding theory on the instrument, reading, and improvising (much of which he did through the use of jazz music).

However, these lessons were not jazz-specific and were only at level 3 of education (below higher education). From that point, a combination of personal intuition, research, studying through books, lessons and video tutorials, all at different times over many years, got me to the point where I felt that I could actually play jazz.

It is also true that many of the jazz players I interviewed are completely self-taught. This is true of John Harper, who (even though he had lessons later in his career in other styles) taught himself to play jazz; as well as Martin Taylor, who has been completely self-taught from the very beginning to this day, becoming one of the most celebrated solo jazz guitarists of our time.

### *Classical interviews*

It was surprising for me that most of the classical guitarists I interviewed were also initially self-taught. Only a couple of them started directly with lessons and within the classical style (Craig Ogden and Sam Rodwell). Of the majority group, Emma Smith (2014) learned the guitar briefly at school in non style-specific lessons before quickly getting interested in the classical style thereafter. Steve Davismoon took his first guitar lessons in his early twenties in the classical genre after teaching himself for a number of years. Others like James Girling and Jamie Macrae taught themselves in styles such as rock, blues and jazz before starting to take lessons in the classical style.

It has been interesting to find out that, even though the classical style is often seen as a much more rigid school which can most successfully be accessed from a very young age and through formal lessons, several greatly accomplished players have actually started through different means before becoming interested in the classical style and being formally taught. However, an important difference between players in these two styles is that, eventually for classical players, a long period of formal lessons at an advanced level does become something that they all have done, without exceptions. This is not the case with many jazz players.

It is easy to think of modern resources - such as the internet and the vast number of instructional text publications - as likely reasons why many classical players today go

through a period of self-tuition on the instrument before starting lessons. In previous centuries (particularly before the internet was the main source of information) it would likely have been much harder to acquire an equivalent amount of information without seeking someone else's instruction.

John Harper has been a professional guitarist in the United Kingdom for over fifty years. He started with jazz and the electric guitar, and eventually also learned and worked as a classical guitarist. During his interview with me he pointed out that in Liverpool, his hometown, in the 1950s and 60s, when he was starting his career as a professional, there was virtually no presence of the classical guitar "I didn't play the classical guitar, but neither did anybody else in Liverpool at that time" he continues "There were not any classical guitar teachers around" (Harper, 2014). He mentions that, as the classical style gradually became more popular in the 1960s- in no small amount due to the rise of John Williams as a young prodigy, he got interested and realised that there was also a good opportunity to generate income, due to a growing demand for tuition. He eventually found a classical tutor through the Royal Northern College of Music in Manchester.

It is hard to imagine a similar situation happening to a young guitarist interested in the classical style in the present day, particularly in one of the biggest cities in the country. This points towards a significant change in the last fifty years in the way that many people initiate themselves in this guitar genre.

**Question 2 - Would you change/do anything differently, if you could go back, about the way in which you have learned and the things you have practiced?**

#### *Jazz interviews*

The answers to this question are mostly individual for each of the players interviewed. However, there are some interesting thoughts and threads that have emerged from these answers which are relevant to the research.

Alan Williams is a jazz guitarist, although he now dedicates himself mostly to the areas of composition, singing, lecturing, and academia. His answer to this question is one which actually coincides with one of the most important conclusions I reached through the interview and research process. Williams (2014) says “I think I might choose to go back and actually study classical guitar. Although I love playing jazz - and I’ve got reasonable technique and I am able to play most of the things that I want to play, knowing what I know now as a composer, I know that the classical guitar technique is a pretty much more flexible technique, and that more can be done. It certainly opens up possibilities in terms of colour” William continues “There is a kind of conceptual divide between the single line and the chord that happens in pop and folk guitar, and also to an extent in jazz” he pauses before adding “Because in classical technique you don’t learn chords, I mean, they arise out of the music and of course they are chords, but you don’t learn chords as chord positions, I think that makes for a much more blended kind of technique” he concludes “One of the earliest recordings of classical guitar that I heard was Narciso Yepes playing Bach. He was able to project counterpoint through the guitar, which I think is really hard to do, and I don’t think I ever managed to do it in jazz although I hear it. I think classical guitar technique at its best, enables people to do that”. I found Williams’ answer to be of particular value since, as a composer, he has an advanced sense of the possibilities for colour and tone music. As he says “knowing what he knows as a composer” he can see a much more flexible technique in the classical style, which allows for more to be done.

Although I have personally not explored the world of solo counterpoint jazz improvisation as much as somebody such as Martin Taylor, I can say that as a jazz player, I have personally experienced many of the benefits that Williams refers to thanks to my own study of the classical guitar. The solo jazz arrangements that I have made (of which there are examples in the demonstrations video that accompanies this thesis in Appendix 1) would not be possible for me to play properly without the technique that I have acquired through my classical studies. This is true for the tone and colour aspects of the performances, as well as for the way in which

elements of melody, bass and chords are incorporated into one instrumental performance.

Another interesting answer to the question was that of aforementioned internationally celebrated jazz guitarist Martin Taylor (who, coincidentally, was Alan Williams' inspiration for learning jazz guitar). He is indeed a master of solo performance in jazz, and is able to incorporate improvised counterpoint as well as walking bass, chord-melody and all other stylistic devices. Taylor (2015) says "I am grateful for the fact that I learned how to play first of all by ear, and then learned to read music later. But I wish that I had studied orchestration. I would have loved to write music and arrange for an orchestra".

This aural development is certainly one of the key elements of jazz playing and improvisation. Jazz first originated as a style which was developed and passed on through listening. Although orchestration, theory and notation came in later with arranging and with more advanced sub-genres, an acute listening ability is still needed for musicians to be able to recognise scales, intervals and chords by ear, enabling them to improvise with a much greater sense of control, freedom and spontaneity. For many classical players, the idea of playing by ear, away from notation or memory, is a daunting prospect. As we will discover amongst the classical answers that follow, many classical guitarists actually wish they had been provided with the ear training that Martin mentioned previously, and pointed out he was grateful for having done first.

### *Classical interviews*

There were different things mentioned by classical guitarists when answering this question. For example, Emma Smith wishes that she had started younger on the instrument. Steve Davismoon would have liked to have been more patient with himself as far as perfecting and internalising the performance of pieces early on in his advanced training. Interestingly, David Oakes mentioned networking with established musicians as something very important, and he wishes that he would have done it more extensively earlier in his career.

However, four classical guitarists have something in common in their answers. They wish that they had been provided with something that the classical school as a whole did not offer. Of them, three coincide in what that something is specifically.

Sam Rodwell, Craig Ogden and Jamie Macrae all wish they had been taught to play by ear and develop listening skills much earlier in their development as musicians. Rodwell (2014) says “I’ve never played by ear. I fell into classical guitar at a very young age and stuck with it, stayed focused on that and didn’t really do other styles. If I was to go back I would have liked my teacher to have taught me a little bit by ear so my ear was more in tune with intervals, etc. I realised when I got to college that my dictation was unbelievably bad”.

Although Jamie Macrae didn’t start with the classical guitar but with rock and blues instead, he also initially learned by concentrating more on shapes and the movement of the fingers. “I would learn the aural aspect of the modes or scales that I was playing more thoroughly before I went into just playing them. I think learning that is just as important as learning the technique of playing through the scale” (Macrae, 2014). Similarly, when asked the same question, internationally acclaimed classical player Craig Ogden (2014) said “Yes, there is one absolutely key thing (that I would change), and that is that I would have hugely valued being made to play by ear more from the very beginning. That is the one great thing that I feel very insecure about” Craig later goes on to mention that he feels his natural ear is actually quite good, however he would have liked to have been encouraged to use it more “I have done enough to know that I hear things effectively, but I am very slow to work things out by ear, to analyse chord harmonies by ear, or to notate things by ear. I find it quite hard but I get there in the end”. He later concludes that, if apart from having been made to develop all the skills that he did develop, he would have also been encouraged to work on the aural side, it would have been highly beneficial “It would have made such a big difference to the general development and my own feeling of being a broad, well trained, well educated musician. That’s the one thing I would completely change”.



Royal Northern College of Music classical guitar graduate David Bainbridge points to what could be one of the causes for the lack of attention given to aural skills in the training of many classical guitarists “I wish that the system of classical tuition was more exploratory and it had a more open-minded approach. It is basically old fashioned and based mostly on playing old pieces” (Bainbridge, 2014).

It is interesting to see that many interviewees have given quite different answers to this question, particularly within the jazz group. At the same time, a thread has been discovered in the way that a considerable percentage of the classical guitarists (particularly those who have not had any experience in other genres) feel about their lack of listening and aural skills.

Although there is not enough evidence at this point to suggest that this is also a clear thread, it is interesting to see how a jazz guitarist (Alan Williams), who has later gained advanced knowledge in areas such as colour, texture, orchestration and counterpoint as a classical composer, points to the classical guitar as a style with more versatile technique and tone possibilities.

### **Question 3 - Have you ever come in contact with the classical/jazz school of playing? What do you know about it?**

#### *Jazz interviews*

Many jazz players I interviewed have a general understanding of what is involved in the classical guitar, whilst not being aware of many things beyond the basics. They tend to know that the classical style focuses primarily on areas of technique and repertoire which includes physically demanding, often long pieces. Anton Hunter (2015) says “I don’t know much. I know it’s really difficult”, he later adds “I had some classical guitar lessons for a brief period. We had a lot of weeks on tone production. That is something that I have not spent much time on at all as an electric guitarist, or as a non-classical guitarist -tone production with the fingers and with the interaction between you and the instrument”.

However, a number of them have had the opportunity to learn more directly and profoundly about the actual advances and reasoning behind the classical technical and ideological approach. These include John Harper, Stuart McCallum, Martin Taylor and Jim Faulkner.

Stuart McCallum is one of the most respected jazz guitarists in the North West of England and throughout the UK. He is also currently head of jazz guitar at the Leeds College of Music. His work as a guitarist with the Cinematic Orchestra, as well as under his own name incorporates a thorough understanding and command of the jazz vocabulary, whilst embracing technology and exploring soundscapes and minimalism. After many years of playing, Stuart has become interested in the classical guitar, and is currently starting to take some lessons. Referring to how jazz pianists frequently study classical piano works as a gateway to harmonic ideas of voicing, development and composition McCallum (2015) says “I have always felt annoyed that pianists had this amazing resource to get into the instrument, and guitarists didn’t have that. But then I realised that we do, we just need to get into it” he continues “It’s a different approach but it’s all there, if you want to get into it. So I’ve started to get into it, learning some Villa Lobos pieces, etc”. Given that the classical guitar is most often associated with technique and tone in performance, this is perhaps not one of the most obvious or predictable areas of benefit that jazz guitarists tend to expect from learning about the classical guitar. In my personal experience of many years of studying and playing jazz, I was never advised by tutors to look at classical guitar in order to improve my skills. Similarly, I never heard it from peers. I did arrive at it later by accident, however, once I had started studying the classical guitar simply because of my love for the music.

In my opinion, the principles and vision of harmony that derive from classical music are very similarly, if not equivalently, applied to classical guitar pieces as they are to classical piano pieces. It is certainly true that the piano has been a protagonist in the history and development of classical music in a way that the classical guitar has not. Nonetheless, whilst this might mean that the guitar might not have the same quantity of material available, today one can say that the classical language and its full vision

and approach have been successfully transferred to the guitar. This is true both for transcriptions of pieces by great piano and keyboard composers from the past, such as Bach or Albeniz; as well as repertoire specifically created for the instrument in the 19<sup>th</sup> and 20<sup>th</sup> century. Such is the case of several world renowned works by composers like Agustin Barrios Mangore, Joaquin Rodrigo, Antonio Lauro, Leo Brouwer, Benjamin Britten, Manuel de Falla or Heitor Villa Lobos, amongst many others.

Guitarist Jim Faulkner is an unusual musician in the sense that he is a jazz player who, by chance, actually started on the instrument in the classical style; simply because that was the kind of tutor his dad was able to find for him. “It gave me such a good foundation. I don’t know if I would be doing what I am doing now if I hadn’t had that (classical) foundation” (Faulkner, 2015). He mentions that, although he only had these early lessons for two-to-three years, (and never really mastered the right hand classical technique) he acquired what he believes are good habits including learning to read. About his first lesson, Faulkner said “He wrote G on the treble clef and got me to do m-i-m-i-m-i, and got me started on the reading thing from day one”.

As a jazz teacher Faulkner now works at Chethams School of Music in Manchester, UK. There he has a rare opportunity - apart from his formal jazz students, he teaches jazz guitar as a second study to classical guitarists. About this experience with guitarists from both genres, Faulkner (2015) says “I hear far more about jazz guitarists suffering playing-related injuries than I do with classical”. He has also had a personal situation where, due to health reasons, he has gravitated towards adopting classical principles in his posture. “A few years ago I got a trapped nerve in my left arm, which was incredibly painful and quite debilitating and I kind of thought that it was going to be the end of my career. Through taking Alexander Technique lessons, getting physiotherapy, and doing a bit of reading, I had to find out about what was the most logical way to hold the instrument to cause the least distress to my arm and my injury- to not aggravate it” he continues “As a result of having to do that I had to completely change my posture and, ironically, hold the guitar more like a classical player”.

### *Classical interviews*

The general answer from classical players has been that they have a basic understanding of the main skills that are needed for jazz. However (as with jazz guitarists) beyond this, their knowledge tends to be very limited. For example, almost nobody mentioned anything related to ii V I - based chord progressions, arpeggios, chromaticism, intervals, modes, different kinds of chords or jazz repertoire, etc. Emma Smith, for example, mentions taking a jazz module during one term at the start of her college studies. However, she admits that she now doesn't remember most of the information provided, but she wishes she had tried to absorb more of it as she thinks it would be useful now.

One particularly interesting answer was that of Craig Ogden, who mentioned that he finds that classical music makes use of tempo changes in order to convey musical expression, whilst most other musical styles have a rather continuous metronomic-oriented approach to time.

About jazz, Ogden (2014) said "I enjoy it. The only thing for me is that, some of the jazz that I've heard, I find twenty minutes of it awesome and entertaining. But after that – I suspect it's my own lack of understanding- I get a bit bored. In classical music, there is always contrasting tempos, articulations, dynamics, rubato, textures. In pop music and some jazz there is less variety of texture". This is something that I personally also found very appealing once I started to study classical guitar in depth. Even though I already knew about classical music and listened to a fair amount of it, as a player I realised that there were more opportunities to enhance musical expression in the classical style, whilst jazz and other styles of music had not made me aware of it, at least not to the same extent. Ogden continues "You know, a lot of jazz doesn't slow down and speed up, and in classical phrasing you always move forwards and backwards. Even Bach, it's about holding back and moving forwards – you are telling a story using those tools".

As previously mentioned, David Bainbridge is a Royal Northern College of Music classical guitar graduate. He did jazz guitar as a second study during his pre-college

studies at Chethams School of Music in Manchester. He also later played in the Royal Northern College of Music Jazz Big Band. Based on his experience of both genres, Bainbridge (2014) mentioned that chord chart reading through chord symbols would represent a problem for many classical guitarists, since they are not used in that style.

David Oakes is a jazz and classical guitarist whose experience ranges from learning and jamming with Joe Pass in the jazz style, to attending Andres Segovia master classes in the classical style and leading guitar departments at different advanced music institutions in the United States. During my interview with him, he mentioned something which is relevant both to this and other questions on this list. Oakes (2014) said “At USC (University of South Carolina) they once were having a big fundraiser and a lot of the students were performing. This guitar player got up and played a Scarlatti Sonata. It was absolutely beautiful, breath taking” Oakes continues “Later on, a singer was going to sing and their accompanist couldn’t make it, and she had a simple chord chart, which just said Cmaj7, Dm7, Em7. So they asked the guitar player to accompany her, and he couldn’t do it!”. Later on, Oakes mentions that the Dean of the music department was so disappointed in their current guitar teachers after the event, that the occasion turned out to be one of the reasons why Oakes eventually got hired to teach guitar at the University.

As the reader may have noticed so far in these chapters analysing the interview-based research, as well as most of my research (including the content of the vast majority of texts for classical guitar tuition), there is a major reappearing thread, which is that huge numbers of highly trained classical guitarists don’t have the ability to understand the harmonic and compositional elements of the music that they play. Their connection with the music is limited to successfully reproducing notes on the instrument as specified by the score, with great expressive skill at times, but without any understanding of the deep reasoning behind those notes and their dramatic purpose, from a technical compositional perspective.

According to the research, however, this seems to be the consequence of the teaching practice and learning material in the style, rather than a conscious decision

made by students to learn in this way. More information regarding this phenomenon and its consequences is included in the remaining paragraphs of this section (as well as the rest of the research).

**Question 4- Between the Jazz and Classical styles, which of the two do you think is more demanding and why?**

*Jazz interviews*

This was perhaps the question that got the most similar answers from all guitarists. The vast majority decided not to select either of them as more demanding than the other.

Jazz guitarists, as well as classical, often stated that both were highly demanding in very different ways, with many mentioning that they were different worlds. As a player who has dedicated many years to the study of both, I personally agree with this opinion. Their priorities are contrastingly different, but equally demanding of the player's attention and dedication. This kind of perspective given by the vast majority of interviewees reveals that there is a sense of respect and humility shown amongst guitarists regarding each other's achievements.

An interesting answer was given by jazz guitarist Matthew Campbell (2015), which deviates slightly from the majority. He says that, whilst they are both hugely demanding, he thinks perhaps the jazz style can be considered more so because of the lack of rules and the element of improvisation, as opposed to playing music which is already conceived.

This perhaps suggests a certain amount of subjectivism as to what is considered more demanding by different people, more freedom (generally jazz) or more restriction (generally classical). In this respect Campbell (2015) does mention later that different personal views and opinions could lead to different perspectives on this.

*Classical interviews*

Similarly to the jazz players, classical interviewees have expressed a lot of humility regarding their answers to this question. They don't think there is a style that is more demanding overall than the other, and they mostly tend to think that the priorities of both are so different that they are best judged separately.

James Girling is within the small number of players who dedicates himself to both jazz and classical guitar, although as a student at the Royal Northern College of Music he is enrolled as a classical guitarist. Whilst sympathising with the general answer as explained above, Girling (2014) mentioned that he thinks "It is easier to be a half-decent jazz guitarist. It is not very easy to be a half decent classical guitarist". I found this part of his answer interesting, particularly coming from an advanced player of both styles, and asked him why he thought that was, to which he replied "I think you can more easily bluff on an amplified electric instrument". He continued by talking about his approach to the electric guitar: "Personally, I don't go for effects and things like that. I like a sound that is as clean and close to the guitar's roots as I can, when I play jazz guitar. But you can disguise mistakes far more easily; whereas all your mistakes are exposed when you are playing a classical instrument".

**Question 5 - Do you think there is currently good communication between the classical and jazz genres? If not, how could we improve it?**

*Jazz interviews*

Asking about the communication between the styles provided some of the most interesting answers that shed light into the current awareness that players in these styles have about each other's schools. The feeling amongst some jazz guitarists is that classical players and the classical school are often unwilling to really open up too much to allow for better communication between the styles.

Adam Palma is one of the most highly regarded jazz guitarists in the Manchester area. He has also performed alongside some of the most celebrated guitarists in both the classical and jazz genres. One of these occasions was a concert where he

shared the stage with jazz guitar virtuoso Tommy Emmanuel, and classical guitar virtuoso Craig Ogden. There he played a jazz duo with Emmanuel, and then Emmanuel played a classical-jazz duo with Ogden. During our interview he referred to the occasion, and to Ogden. “When he (Ogden) played with Tommy, he played exactly his piece, and Tommy played on top of it, which doesn’t make sense. Whether people liked it or not, I have no idea” he paused for a moment “But it’s not opening (to another style), because opening would be –“Hey Tommy, lets play Etude, or whatever, and lets improvise”--. Fine. But if I play exactly what is written and somebody else is messing about on top of it, it is not improvisation, it has nothing to do with it” (Palma, 2015).

The classical world itself as a whole (not specifically guitar) has for decades incorporated amplification and the electric guitar in modern works, with works such as ‘Electric Counterpoint’ by Steve Reich and ‘Scorched’ by Mark-Anthony Turnage incorporating well respected jazz guitarists Pat Metheny and John Scofield respectively. However, the two guitar styles themselves have not developed an ongoing relationship, with few projects made where the two traditions really meet halfway to collaborate. Of the few that have, one could perhaps think of the duos between John Williams (classical) and John Etheridge (jazz), and between Martin Taylor (jazz) and Carlos Bonell (classical).

During my interview with Taylor (2015), he in fact revealed that he has collaborated with different classical guitarists, adding Simon Dinnigan, Badi Asaad and Jorge Morel to the list. However, Taylor mentions “I don’t know much about the classical school of playing, although I am quite familiar with the more popular classical guitar repertoire. I have never played classical guitar”.

It seems that even if there have been some collaborations and occasions where jazz and classical guitar meet (such as Taylor’s, Emmanuel’s or Etheridge’s duos with classical guitarists), most of the time, players do not seem to get to a point where they actually absorb much about the opposite style of playing beyond being involved in a performance with somebody from that school. Furthermore (whilst this is not



necessarily a priority) they do not seem to try to incorporate any elements from each other's styles into what they actually do.

Jazz Guitarist Brad Edmonson (2015) says "In my experience I think there is a definite lack of communication between the classical and jazz genres. I think classical and jazz guitarists should make more of an effort to collaborate in both composition and performance, which should in turn hopefully improve communication between the genres".

In general, there is a feeling amongst the majority of the jazz players interviewed that there should indeed be more, and better, communication between the two styles.

### *Classical interviews*

It is also the shared opinion amongst the majority of classical players that there is insufficient communication between the two styles. Interestingly, like jazz guitarists, classical players themselves often see a lack of openness and flexibility within the classical guitar school, making it difficult to absorb elements that come from other genres. As a side-observation, I find it very interesting that a general trend seems to have gradually developed in the last fifty or so years towards a more open-minded and curious outlook from classical guitarists towards other styles of playing (jazz in particular), and the interviews also support this view.

Some of the biggest names in the classical world over the last fifty years have made an effort to interact with other genres (however infrequently), such as Julian Bream - who famously played with jazz and world musicians, John Williams- who played in pop groups and with jazz players, Manuel Barrueco – who has done jazz and pop duets, and Leo Brouwer – who has covered pop songs and taught jazz players. Crucially, however, the schools and environments from which these players actually come for the most part do not seem actually to have facilitated these kinds of meetings for the players, often by implication achieving the opposite to a large degree.

So the comparatively very small number of players who have branched out have had to find their own way and, importantly, for the majority who have actually collaborated, these collaborations mean that they always stay in their own style of playing when they are in a duo or ensemble with other musicians, as opposed to improvising or using their ears or using other techniques outside of those used in classical performance.

Whilst answering this question, Craig Ogden (2014) said that had he been taught to use his ears more and improvise, he would be much more inclined to try to work with jazz players and other improvisers. He expanded “If I was more fluent by ear, I would be more comfortable making those connections. So I would blame me, and my education, for the barrier that still exists between me and jazz players” he adds “I think better education for classical players would help to break down those barriers”.

### **Question 6- Do you think it is important for classical players to understand the harmonic and compositional components of the music that they play?**

#### *Jazz interviews*

Most jazz guitarists regarded an understanding of the harmony of the music that is played an important tool to have, even if you were not required to improvise.

Martin Taylor (2015) mentioned during his interview with me that “It is important for all musicians to understand how the music they are playing is constructed. I spend a lot of time with my students getting them to identify what they are playing rather than just learning where to put their fingers like a robot. It’s a problem that both classical and jazz guitarists seem to have”.

Jazz guitarist and Royal Northern College of Music graduate, Daniel Brew (2014) also supports this idea, stating “I guess it’s down to choice, but I think the person will be a better and more sensitive musician to the music that they are playing if they do understand it, regardless of the style”.

For jazz guitarists, of course, an understanding of the harmonic structure of the music they play is an essential tool that enables them to function in that style. Interestingly, in my personal experience, for any guitarist that I have ever met who has in one way or another thoroughly studied that aspect of music, it becomes a skill that they put into use for basically anything that they ever play on their instrument. It is by no means used exclusively in their jazz playing, even if that is where it was initially learnt, but to break down the harmonic and compositional building blocks of any music they work with.

### *Classical interviews*

The majority of classical guitar interviewees agreed in their view that the knowledge of harmony and compositional techniques is something positive, and that it helps in interpretation. Perhaps one of the strongest answers in this regard was that of Steve Davismoon. "It's critical. If you can't understand it you'll never play music". After this initial answer, I mentioned to him that I have found many advanced and professional players who concentrate very heavily on technique, and yet don't give the same amount of attention to the harmonic and compositional understanding of the music they play. He added that "They'll never be the great players. They'll never be the John Williams or the Segovia of this world". Expanding on his answer he later said "You can't play Bach and not know how it is working, structurally. If you don't, you won't be playing it, as simple as that. Bach is a really good example of when the technical and the content come absolutely together. If you don't understand how it's working musically, you won't be playing it. You will be ringing the notes, but you won't be playing the music. You won't be pointing or waiting for phrases according to the harmonic rhythm and so on" (Davismoon, 2014).

Interestingly, however, for most of the classical interviewees who agree with the overall idea that this ability is either vital or very positive, their own skill in this area has often actually been acquired outside of their classical guitar training. These include Steve Davismoon himself, who (even though his opinion in favour of this knowledge was the strongest amongst all interviewees) admitted that his guitar training did not provide him with it, but that it was only after later studies in music and

composition that he gained the knowledge, which he would then transfer to his guitar playing.

Jim Faulkner is mainly a jazz guitarist. However he is worth mentioning again within the classical guitarists' answers for this question as he is able to provide further evidence that classical guitarists, at least in the present day, are not usually receiving an in-depth education in the area of harmonic understanding. As a jazz teacher instructing classical guitarists on jazz principles he says "One thing I have found quite often with them (classical players) is they don't have that depth of theory. I can remember once I was teaching this classical guitarist, and he was a brilliant guitarist. It sounded beautiful. We were starting basic jazz lessons and I asked him what was in a D7 chord, and it took him minutes to figure it out. He was playing the chord there and couldn't for some reason figure the notes out" he continues "It was amazing because he was able to play all this stuff and it would sound so beautiful" (Faulkner, 2015).

I personally agree with the opinion that a good understanding of the harmonic content of the music we play is important and valuable, whether we are supposed to improvise over it or not. In my opinion, the interpretative role of the musician in either case can be more effectively and profoundly approached in this way as, from a compositional perspective, these devices are used to suggest particular sensibilities and intentions. For example, we can look at a perfect cadence from an altered dominant chord as a change from tension to release which is supposed to bring the piece or phrase to a resting place, and therefore apply the necessary attack and tone (also taking into account the general style and mood of the music) in order to emphasise that intention to rest and breathe easily, as well as prepare for it. From my experience, knowing these aspects about a piece enhances my confidence as to how I can and should interpret each section of music as effectively as possible, as well as allowing me to be more effective in my attempt to fulfil the composer's purpose and vision.

## **Question 7 – Do you think it is possible to play both styles at a high level?**

### *Jazz interviews*

There is a shared feeling of respect amongst all guitarists about the demands of both the classical and jazz genres. Most agree that in order to reach the highest level possible at either of these styles one needs to prioritise it above all others, and spend a lifetime dedicated to it, usually in an exclusive manner. However, that is not to say that certain elements from other styles cannot be absorbed, whilst not necessarily mastering the style which we absorb them from.

One of the most interesting answers to this question came from Daniel Brew (2014), who said “I think no” then paused and added “but I don’t think it should be no” he continued “If there is more communication between them and they start working together. But at the moment the two worlds are completely different”. He also eventually said (agreeing with most) that he believes it is possible to be competent but not “outstandingly incredible” at both. He is also amongst the interviewees who view the two almost as different instruments.

John Harper (2014), who has dedicated his life to both styles, says “I think it is almost impossible to keep up the same standard on both”. Harper has worked professionally in both genres and explained to me how he believes that the two demand such different ways of thinking that it is easy to lose the habit of thinking in both ways if one spends more than a little time working on one.

### *Classical interviews*

There is a similar general notion between the classical players. Royal Northern College of Music postgraduate Emma Smith (2014) says “I think that, although I would love to be able to play jazz, I think I have convinced myself that I have not got enough time to actually dedicate to it”. David Bainbridge, also agrees saying, that “You are always going to be likely to dedicate a little bit more time to one than the other” making your ability at that style more advanced. However, he did mention that

he thinks it is possible to reach a very high level at both with a lot of time and careful practice dedicated to them.

For many interviewees this question has proved challenging, clearly being something that they have not necessarily considered previously to any great degree. All of them seem not only to agree that it would be extremely hard to arrive at a high level on both, but that the current conditions are not in favour of that happening either. Apart from the purely technical side, the two styles seem to create in the player very different ideologies and mentalities about how music (and musical achievement) should actually be understood and valued. On the one hand, through classical guitar study we tend to value mostly the technical proficiency as well as the interpretative skill of the musician. On the other hand, in jazz we tend to value mostly the individuality and self-expressive qualities of the musician through improvisation. So we not only have a technical problem but, perhaps most importantly, a problem of different musical goals and priorities- a problem of ideology.

## **Observations**

For me the most important observation I have made overall is that all guitarists in either genre who truly understand the advances of the other style feel very fortunate to have that knowledge and enthusiastically mention that it has allowed them to improve not only their understanding of another style but, most importantly, their ability to work in their own style, without necessarily making any kind of direct reference to the other in performance. I personally share that view. A complete practical understanding of harmony is not only useful in jazz, and it need not make a direct reference to jazz in sound (for example when used to understand the harmonic content of a piece by Enrique Granados or any other classical composer). Likewise, an in-depth understanding of the physics of tone production on the guitar and how to access the multiple different sounds that a string can actually make does not make a direct reference to classical music in sound (for example when being used to bring out a melody within a solo jazz arrangement, easily create advanced fingerings to

incorporate effective voice leading, or to create a voicing of a chord incorporating open and held strings which is unique to a specific key on the guitar- and has a unique colour).

There was also a clear agreement amongst the majority of guitarists interviewed that the communication between these genres still leaves much to be desired, and they are in general certainly enthusiastic about the possibility of bringing the two closer and facilitate the improvement of their relationship, seeing it as a source of potential benefit for both genres.

Clear was also the previously mentioned thread that most highly trained classical guitarists are not having in depth tuition in areas of harmony and composition that could allow them to further-enrich their interpretative skills, based on a technical understanding of the compositional tools used by composers during the conception of the pieces. Similarly, these interviews suggest that jazz guitarists seem to have a much more limited knowledge of areas that the classical genre has studied deeply, such as control over tone and colour production and the unique possibilities that the guitar offers in this area, as well as how to approach counterpoint on the guitar.

## A phenomenological analysis of the author's own experience

### Introduction

The idea for this research project first originated through my own practice and study of the classical and jazz guitar. It was through finding out first-hand as a player about the vastly different advancements that each of these styles has made in the field of guitar music that I first started to become curious about the idea of them informing and complementing, each other.

As a student who has dedicated by this point several years to the intense study of jazz and classical, I feel lucky to be in what I now know is a rare position that allows me to look at both styles from the inside. In my own experience as a player, teacher and student, I have met hundreds of professional guitarists in all genres, many of whom are highly skilled at performing in more than one style. However, of all of them, there are very few who are professional (or even advanced) players in both classical and jazz. This is probably because the ideologies and priorities that they are defined by are more drastically different, as well as the fact that each of them is widely considered to demand full and exclusive dedication from any player who seeks to perform them at a high level.

In my personal experience, I studied jazz intensely for several years before becoming interested in the classical style. Eventually, I started becoming attracted to the classical guitar as a listener, mainly because it represented a fresh sound and approach compared to what had become my routine in jazz. As I became more and more interested in the classical guitar repertoire I eventually decided to start learning it formally alongside my jazz playing. It was at this point that I began to discover the real demands of the style and, as I made progress, I found that my exploration of the classical guitar was having a beneficial impact on my playing overall, including my



skills in the jazz style. I also eventually discovered that my background in jazz seemed to help me with certain aspects of my classical playing.

As soon as this started to happen I realised that I wanted, eventually, to share those benefits that I had found with other guitarists so that they could have an opportunity to access them, or access what they thought could be of interest to them from the things I had tested. Interestingly, even though it was very evident to me that there was plenty to benefit from, I had very rarely heard of how these guitar styles could inform one another, and had certainly never seen any formal reports on it.

#### *Overview of how the classical guitar benefitted my jazz playing*

I discovered that when I approached the jazz guitar technically with the knowledge that I had acquired through my classical studies, I was able to control the sound that the instrument produced much more effectively than I could before. Whilst I wasn't trying to make the jazz guitar sound like a classical guitar, it allowed me to understand the reasons why a string produces a certain sound, according to the surface of the body that plucks it, its motion, angle, and the understanding of how a guitar string actually behaves physically when it is plucked in relation to the body of the instrument. This improved my ability to shape the sound to my liking and musical needs, whatever that sound might be and in whatever style. An in-detail explanation of the behaviour of strings can be found in the *Identifying a series of important classically-derived advances to inform jazz playing and plectrum technique* chapter of this thesis.

The consciously controlled use of *rubato* in classical guitar forced me to study in detail how the use of time can work to enhance and maximize the potential of the sensibilities suggested in a piece of music. In jazz, feeling is a massively important ingredient. However, apart from mentioning the importance of individuality, spontaneity and self-expression, the vast majority of jazz instructional material does not include any in depth information for the development, practice or refinement of *rubato* or how to use timing and dynamic expression in interpretation. I was then able

to use this outside of the classical style, increasing my awareness of how the listener perceives the temporal aspects of music, and how a performer's careful attention to this aspect can significantly enhance the listening experience.

In jazz it is common practice (and often encouraged by teachers) for piano players to look at classical piano pieces as a resource for learning about harmony, voicings, voice leading and compositional devices. Jazz guitarists such as John Scofield (2014) have said that they don't have the same kind of resource available to them, because the classical guitar repertoire doesn't offer the same tools. During my interview with jazz guitarist Stuart McCallum in 2015 (included in this thesis and quoted in the *Interview-based research* chapter) he also confirms this tendency amongst jazz players, whilst mentioning that he is amongst the minority that disagrees with that opinion. This is something that I have personally also heard many times in my personal experience as a guitarist.

I also happen to disagree with that idea. Whilst it is true that the classical guitar repertoire is nowhere near as extensive as the classical piano repertoire (simply because the keyboard has been, as a performing and composing instrument, the most central tool for classical music making for many centuries), composers have applied the same understanding of harmonic and compositional techniques found throughout classical music to the guitar, such as harmonic voicing, voice leading, counterpoint, contrary motion, orchestration and development. As a jazz guitarist (and much in the same way as a jazz pianist would) I have been able to break down classical guitar pieces harmonically and compositionally, to find new ways of expressing harmony and new ideas for what is actually possible on the instrument. Similarly, as classical technique does with physical considerations, classical music composed for the guitar meticulously examines and considers all of the different effects and sound colours that are possible on the instrument as a palette to choose from at any given time, in ways that are relevant for guitarists interested in these qualities of sound regardless of their genre.

### *Overview of how the jazz guitar benefited my classical playing*

On the classical side, coming from a jazz background has enhanced my awareness of the harmonic movement in any given piece of music I play. I have been able to understand classical pieces not only from a performance point of view, but from a compositional point of view. I found that this was of great help when learning any new piece because it allowed me to understand what the composer's intentions were in a much more direct and clear way. Apart from this, the knowledge of harmony allowed me to add the occasional personal touch to things such as chord voicings in certain pieces, or easily finding different positions in which to play a phrase or arpeggio, basically allowing me to bring some elements of arranging into learned pieces, whilst respecting the composer's intentions and the full structure of the piece. As discussed in other parts of the thesis, and revealed extensively throughout my interviews with professionals in the field for this research, this is an area of knowledge that many classical guitarists today seem to lack.

Another aspect that I feel I was able to bring from jazz to benefit my classical playing was that of responding to the imagination and environment in the moment, and playing what I hear. After all, as a jazz player, the skill of listening and detecting things by ear is a priority. In a classical context this has meant that I might lean on a particular note a little bit differently from one time to another, or play a certain phrase at a different speed or with a different articulation from one performance to another. Listening intently to what the music is saying and responding to it in the moment has become something that affects my playing in both styles and I believe it works in favour of classical performance. After all, even in rehearsed environments where improvisation is supposed to be forbidden, every performance will have (even if only subtle) differences that can be embraced and responded to. In the classical style, although it does not involve choosing what notes to play, I have found that this freedom of approach, as developed through my study of jazz, can help me to add a touch of uniqueness to every performance.

*In the following section I will describe my experience of learning about the standard practices of each style, further elaborating on areas briefly mentioned in this overview. Please note that I will describe my personal journey and findings as a learner of these two styles, giving attention not only to concepts learned, but the phenomenological process.*

### **Personal work on the classical style**

I initially developed my classical guitar skills through the use of exercises and routines many of which were first published in the first half of the 19<sup>th</sup> century (such as those by Dionisio Aguado and Ferdinando Carulli) when the classical guitar first emerged as a new major school of playing. I gained access to this material through different routes, at times using the methods as they were originally published and at times using books which are compilations of exercises by different authors, some of which also include newly-developed exercises which are based on the same basic principles. The most important instructional text publications which I personally used for the development of my classical technique and knowledge were the following:

- **David Oakes – *Classical and Fingerstyle Guitar Techniques* (2000)**

The methods described in Oakes' book arise from a combination of techniques developed by many of the original classical guitar masters (such as Dionisio Aguado, Fernando Carulli, Fernando Sor and Francisco Tarrega) with material transcribed and arranged for the guitar by composers such as J.S Bach. There are also exercises developed by the author himself based on the traditional principles, as well as a small number of contemporary flamenco-influenced ideas.

The author wrote this book for the curriculum of the Musicians Institute of California, an institution dedicated to jazz and popular styles of playing. It

worked particularly well for me since it is designed for guitarists who are already advanced in those other styles and want to access the techniques of classical guitar. In this respect, the book is very unique amongst classical guitar material, which is not usually designed or aimed at guitarists with that particular background.

I completed this method from start to finish, during a period of roughly 30 months between 2010 and 2012. During this period of my development I was splitting my practice time to accommodate jazz and classical styles, doing 1.5 hours of practice on each. I spent 45 minutes-a-day just on these technical exercises and another 45 minutes working on repertoire. At this point, repertoire included Tarrga's *Lagrima* and Fernando Sor's *Andantino in G major Op. 31-5* and *Etude N.6 in D major*.

Studying and applying the techniques covered in this book has had a significant impact on my technical development. I found that it gave me a very good technical grounding from which I could approach complicated repertoire. Earlier, I had simply been trying to play pieces that I did not have the appropriate technique for (even though in jazz terms my technique allowed me to play very comfortable at an advanced level).

#### - **Dionisio Aguado – *Complete Guitar Method***

This is one of the earliest texts describing methods for the classical guitar. First published in 1825, it has also been one of the most influential method books ever to have been published for the classical guitar, and it is still in print. I have used several of its arpeggio exercises and studies, many of which are based on chord shapes on the left hand and enable the learner to concentrate mainly on the use of different plucking patterns on the right hand. This helped me particularly at the beginning, when I was mostly working on getting to use the right hand fingers in the right way and developing their independence (something that proved difficult at first, coming from jazz and being used to playing with a plectrum). Even though

I had used fingerpicking at different times before in a self-taught manner, through this study of the classical guitar I gradually felt that I was able to control my plucking fingers in a way that I couldn't before. During jazz performances when I would at times decide to utilise the technique in order to present harmony in a broken way (as opposed to strumming) I could apply all kinds of interesting patterns within any given chord voicing. For example, in a four note voicing, by playing any sequential combination of thumb, index, middle and ring fingers.

This, as stated before, developed gradually over years, and the more I did it, the more I felt that my hand could do spontaneous fingerpicking patterns without previous practice, seemingly, gradually achieving full finger independence that could be used creatively and cleanly on the spot.

- **Scott Tennant – *Pumping Nylon***

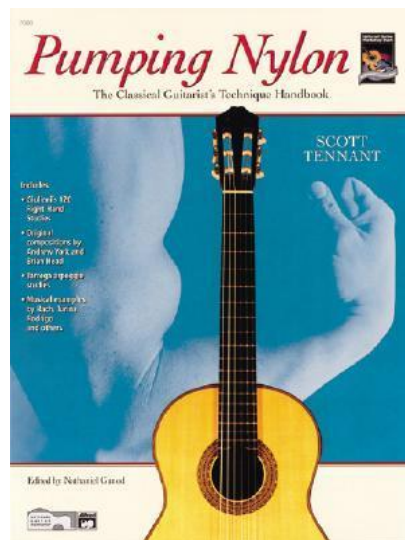

Scott Tennant- *Pumping Nylon – The Classical Guitarist's Technique Handbook* (front cover). Image 49

This is another well-known publication from 1995 and is dedicated exclusively to the subject of classical technical development and efficiency. The author concentrates on right hand techniques separately to left hand techniques, taking the learner from the very basics of technique to advanced concepts and exercises. Some exercises are

created by the author himself based on traditional principles, and some are directly taken from master guitar performers and composers such as Giuliani, Turina and Rodrigo.

I mainly used this book for the purpose of developing my left hand finger independence and strength as well as for developing a technical warm-up routine for the classical guitar. I also used the book to develop the three-note tremolo technique, as featured in pieces such as *Recuerdos de la Alhambra* by Francisco Tarrega. Of all the books used for my classical training, this one still remains in use today, as I use large amounts of its warm-up routine in my practice.

I complemented my study of these texts with a series of private lessons with a mentor and tutor, guitarist and arranger John Harper. John was my arranging lecturer at Salford University in 2008, and I then continued to receive his instruction privately for several years. He turned out to be an ideal teacher for me, as he too had been a professional guitarist specialising in both the classical and jazz guitar.

John was very much of the philosophy that the classical guitar was technically more demanding than the electric or jazz guitar. A master at both styles, he often mentioned that after taking time off from playing the guitar altogether for several days, the classical technique would go in ways that the jazz technique wouldn't.

Apart from this, I also had occasional lessons with other highly-trained local players and students in the Manchester area. Online video master-classes and instructional resources were also an influential source of information in my technical development at all of its stages. I have studied material of this kind by highly regarded players and educators such as David Russell, Sharon Isbin, Alirio Diaz, Julian Bream, John Williams, Andres Segovia, Leo Breuer, Abel Carlevaro, Pepe Romero, Scott Tenant, Frederick Hand and Alice Artzt among others.

## **My findings regarding the priorities of the classical guitar**

Through my years of study of classical guitar techniques, as well as through all the information I have been able to gather through my practice and research for this project, I have come to the conclusion that classical technique is concerned with having the highest level of control possible over the sound that the instrument produces, from the actual source of the sound – the strings, fingers and the body of the guitar. This is done through an understanding of how sound is actually produced on the instrument, and how the hands, fingers, and body can best be used to maximize their potential contribution to sound production and control. Through this understanding, and the use of extensively tested and established development strategies, the player concentrates on achieving the richest, purest and most refined sound possible on the instrument.

With these skills, players aim to perform compositions in a way that meets the stylistic requirements and the composer's vision, as well as introducing their own interpretative skill and sensibility. On this subject, during a television interview, Andres Segovia once mentioned "The composition belongs to the interpreter as much as it does to the composer" (1972). The development of technique, tone, and interpretative skills, are ongoing tasks for classical guitarists; work in these areas doesn't really ever reach an end but instead continues to be further refined and improved indefinitely throughout the player's career. In my development over the first two years (and as suggested by Oakes' method) I practiced a single pluck on an open string with each finger for several minutes as the start of my practice, listening to the sound of the note and its tonal qualities, trying to apply the physical considerations described on the book in order to add body and contour to the note, as well as to develop the ergonomic aspects of the stroke.

As with classical music in general, instrumentalists in this discipline look to the human voice as a reference for a sound that is beautiful and compelling. It is partly for this reason that the style examines the components of tone and execution to the smallest of details



“The secret to making the guitar sound lyrical, like a voice, is to be able to create the sounds in-between the notes and to shape them, so that everything has a contour, just like if you were looking at objects in three dimensions” Sharon Isbin (2012)

Coming from a background of jazz and popular styles of guitar playing, my personal experience of classical guitar technique was not what I had expected. Although I knew that technique was a major component of classical guitar, I had not perceived the actual amount of attention to detail and structured work that was required to develop this technique to a high standard. It was at this point that I began to understand that classical guitar was about a lot more than just the learning of complicated pieces of music by memory.

As I continued my journey towards acquiring classical skills, I gradually understood that the sound that had attracted me so strongly to the style had as much to do with the tonal qualities achieved on the sound of the instrument by players, as it did with the repertoire itself. Even if I could mechanically get through a piece, executing it without the richness in tone colour meant that a massive element was missing from the sound of the music.

## **Aspects of classical technique**

### **Posture**

Unlike most other styles of guitar playing (such as rock, blues or jazz), the classical style has very specific rules that determine how a player should hold the instrument and position his body around it. These rules take into account both the way in which the player will have the best access to the instrument, as well as the way in which he or she will avoid any unnecessary injuries and strains which can be damaging in the short and long term. During his instructional video dedicated to technical principles for guitar playing, master classical guitarist Abel Carlevaro (1997) says “The guitar adapts to the body and not the body to the guitar”.

I achieved the standard classical position through my study of David Oakes' *Classical and Fingerstyle Guitar Techniques* book, as well as receiving instruction from my teacher, John Harper. Both sources provided me with the same established procedure:

- Raising the left leg (for right handed players) with a footstool.
- Placing the guitar's lower inner curvature on the left thigh, with the fretboard facing upwards at an angle of around 30 degrees to the player. Depending on the physical characteristics of the player, the footstool can be lowered or raised in order to achieve this.
- Keeping the back and torso straight yet relaxed; it is important that the player should always aim for a complete state of relaxation.
- There should be no hunching forward in order to see the frets but, instead, the guitar should be perfectly visible to the player whilst adopting a straight position. This is achieved by the guitar being slightly tilted with the sound hole facing upwards a few degrees. This also contributes to the sound travelling upwards towards the back of the room, spreading and reaching all areas more effectively, rather than low and straight if the guitar is being held in such a way that the sound travels parallel to the floor.



Classical Guitar Posture (Image of Andres Segovia). Image 50

I found that I had to take a good amount of time to get used to the new posture. At first, it was very difficult to stay in this position for a while without feeling uncomfortable. I had, after all, played intensively for 12 years with the guitar resting straight on my right thigh, without my feet raised. After several months, I began to be able to stay in this position for longer than around 30 minutes without feeling discomfort and, gradually, this time increased.

Interestingly, in the present day, whenever I have to play anything particularly challenging (whether on the classical or electric guitar), using this posture provides easier access and control of the task at hand, almost making the guitar feel smaller, because the body has much better access to the instrument - left hand has to stretch less to reach the fretboard, the eyes are closer to the frets, and the fretboard is slightly tilted, giving the eyes a better view of the surface of the strings and frets.

#### *Abel Carlevaro*

Additionally to the instruction specified above which I received to achieve the classical posture, it is worth further-describing the previously mentioned instructional video by Uruguayan guitarist Abel Carlevaro from 1997, which greatly influenced the way that I thought about posture. In it, Carlevaro digs deeper in the reasoning behind basic posture, as well as the positioning of the arms and fingers.

He describes what he refers to as *Five Points of Contact* (which are the points where the guitar and the body meet) as the basics of good posture. These points are:

- 1- Where the guitar rests on the left thigh, or 'lower inward curvature'.
- 2- Where the guitar touches the right thigh, with lower bottom of the instruments' body.
- 3- Where the right arm rests on the body, or 'lower outward curvature'
- 4- Where the left hand is positioned on the fretboard.
- 5- Where the guitar meets the right side of the stomach with the back side of the body.

Carlevaro refers to the first four of these points as 'active' points, since with the use of any combination of only three of these, the guitar can be stabilised.

As far as my own experience in this aspect of the classical guitar is concerned, I found that every method, tutor or instructional source I consulted tended to guide the student through the same basic (although at times simplified) steps and principles in order to achieve the same posture. Interestingly, after I became used to it myself, I was able to start avoiding some minor strains that I would usually get in the electric or jazz posture (particularly in my right shoulder where tension would build up). I also became generally more comfortable for longer periods of playing in this position than I was able to when adopting the posture I had developed when playing the electric guitar.

This is one of a number of significant experiences which, coupled with an awareness of its longer history, have led me to believe that the classical guitar as a school is in a unique position when it comes to offering an effective and more extensively tested technical approach to the instrument. Even though I did not immediately start to apply a classical technique as such on the jazz guitar, my understanding and awareness of the different ways in which the body can be positioned towards the instrument increased significantly after I had studied and experienced the methods and ideologies associated with the classical guitar. Relaxation and the conscious maintenance of an effective, tension-free access to the instrument became essential to me in all playing situations.

## **The right hand**

### *Basic position*

According to the texts I consulted, there is a consensus of opinion in that the right arm should be placed over the upper (bigger), outer curvature of the guitar body, with the fingers reaching the strings and placed in the following order for a basic neutral position:

- p (thumb) =6<sup>th</sup> string
- i (index) =3<sup>rd</sup> string
- m (middle) = 2<sup>nd</sup> string
- a (ring finger) =1<sup>st</sup> string

The wrist should not be allowed to bend sideways, down, or up, but should be kept straight. This allows all of the tendons, muscles and bones to behave as naturally as possible, avoiding any unnecessary resistance that could affect performance and endurance, or produce strains.

In my very limited prior experience of finger picking, I had naturally developed an approach to the hand position that was not too far from this. The main thing that proved somewhat challenging in this area was to keep the wrist straight. I was not used to doing this, and it took some discipline and time to do so by second nature. After working for a while in replacing my old habit, it gradually became natural and undoubtedly helped my playing in any style, mostly from the endurance perspective, since I previously did use to build up tension and pain in my right wrist when playing fingerstyle for long periods.

### **The 'note-over-pluck' technique**

Within my studies of the classical guitar I learnt that, apart from the sound of the note itself, the pluck of a string includes within it the sound of the contact of the string with the finger and nail. The note is of course the more important of the two elements and, therefore, the player should aim to reduce this sound in order to make the note more prominent.

To do this, the technique aims both to reduce resistance to the minimum when plucking, and to reduce the amount of time that the nail and flesh are in contact with the string. The finger nails are therefore shaped and conditioned in a way that provides a smooth contact, avoiding any roughness on the surface of the nails.

Apart from the shaping and conditioning of the nails, the physical approach to the pluck is very meticulous. The finger should move through the string quickly to contribute to the reduction of noise. It should move slightly upwards from the string after plucking, using the main joint (the third joint from the nail) as the main source of the movement. This doesn't mean that the other joints are not a part of the movement of the finger as such, but the movement as a whole starts from the main joint, which moves more than the rest.

Coming from the world of jazz and popular music performance, this approach seemed overly meticulous to me, and it wasn't until later, when I started to hear the difference it actually made to the sound that I understood its importance. Previously it seemed to me that in order to get the classical guitar tone one simply had to play the music on a classical guitar and to pluck with the nails with an emphasis on developing speed and finger independence. Once I started trying to play some simple pieces I noticed that, for the most part, they were actually more challenging than I had expected them to be. Although I might have been playing the correct notes, achieving the delicacy and refinement of sound I heard on recordings was, as explained previously, out of my reach.

### **The length and use of the nails**

There is agreement within the texts I have studied, suggesting that the length of the nail should be long enough so that, if placed perpendicularly next to a flat surface, without applying any pressure, the length of the nail is equal to the length of the finger. The nails should also be filed in a particular shape with the inner side of the nail (that which is closest to the thumb) very short, and gradually growing in size towards the opposite side until it reaches the length specified previously. The natural sound of the classical nylon guitar is gentle, and so the purpose of the nails is to help the player achieve more presence and volume in their playing, whilst retaining a purity of sound.

The sound of the strings when plucked only by the nails is particularly bright and heavy in high frequencies, particularly when plucked with the middle part of the nail. This is good for generating presence and volume, as well as a more percussive sound, and is at times used in certain musical passages. However, when this is done the note loses much of its low frequencies and body, deteriorating the fullness of tone. On the other hand, the sound of the string when plucked by the finger skin alone is overly gentle, losing presence and volume.

In order to counterbalance this, the strings are commonly plucked with the nail used in conjunction with the flesh. The string is plucked with the side of the nail/finger which is closest to the thumb, allowing the string to make quick contact with the flesh before moving downwards past the ramp created by the shape of the nails, whilst gaining the tonal qualities of both skin and fingers. During plucking, the nails are therefore not perpendicular to the string, but at an angle of roughly 135 degrees from the fretboard side of the string (or 45 degrees from the bridge side of the string). A practical demonstration of this, along with other techniques discussed in this chapter can be found on the DVD recording included with this thesis, as well as in the chapter titled *Proposing a unified technique and how it might affect jazz and classical guitar syllabi in the future*.

As I was used to approaching the development of technique independently, working within the styles I had played previously, I naturally did the same thing when I first started playing the classical guitar. I borrowed general ideas from people who I had seen, and experimented. At first I grew very long nails without shaping them or smoothing them in any particular way. Then eventually, after not being able to produce the sound I had heard on records and performances, I started looking at books and realised that the vast majority of them included very similar and specific indications of how the nails were to be shaped and put into use.

Like anything I worked on for the classical guitar, the key seemed to be to condition the hand and fingers to move in the new ways, gradually and overtime, through regular application of the principles learned. In this regard, there didn't seem to be much of a mystery regarding how to achieve the task at hand. Patience, on the other

hand, was evidently vital as an ingredient to work alongside the perseverance element.

### **Developing tone**

Once I had started to file and polish my nails in the right way and to grow them to the recommended length, I noticed that, gradually, the sound I was able to produce was much more noise-free than it had been previously. Producing a purer tone in this manner fascinated me, as I was becoming aware that it represented a new window of opportunity for the refinement of my playing in any style.

Using these technical principles demands a lot of attention from the player at the early stages. The movement of the hand and fingers is slow at first, and the player concentrates on the basic motion and use of the fingers before achieving any kind of speed. At least that was the case for me, and what I was encouraged to do by my teacher and methods.

The quality, richness and level of control of the tone has not only been an area that has improved my playing thanks to my study of classical guitar techniques, but it has actually become a subject of fascination that I continue to investigate attentively in my own playing of both the classical and jazz guitar. The study and practice of these classical guitar principles has given me an incredibly useful basis from which I have been able to develop and achieve sounds for all kinds of purposes and styles. In an indirect way, it has also helped me to understand how certain styles of playing (mostly in the popular and folk genres) achieve the sound that they do, as far as the basic physical principles of the way the string is plucked or strummed are concerned. For example, the percussiveness of certain popular and folk styles of plucking is actually emphasized thanks to the longer amount of time that the nails are allowed to stay in contact with the strings as they pluck, as well as the fact that the nail is not shaped in a way that allows it to move smoothly and quickly past the string. This is something that is barely possible to identify as a listener unless one is actually



looking for it specifically, but that, like a good music production element, it can result in an important effect on the overall perception of a piece.

In this regard, as I developed my fingerpicking tone skills through the months and years, they would also gradually become evident in my playing of other styles. Gigging with musicians of all types (and even though fingerpicking of some kind had been a feature of my playing ever since I could remember) I would gradually and increasingly be complimented on my tone in ways that I never used to before. Even though I was using the exact same equipment and settings I had for years, I was now fairly frequently being asked about my settings on amps, sound processing units that I may have been using, or even my guitar (which I hadn't changed since I was 18).

### **Independence of the fingers**

Established classical guitar technique appears to have two main priorities. The first is producing the best sound possible, with the richest tone and the least amount of noise. The second is to employ something frequently known by players as *economy of movement*. This term means that the use of the hand is planned in such a way that it moves as little as possible, reducing the amount of energy expended by each single finger, allowing the player to perform for longer periods with the most economical application of energy. The concept applies both to the left and right hand. During a master class, Julian Bream once said "when the movement of the fingers is small, you've got greater control" (1978).

The physiological structure of the hand means that, by nature, the movement of each finger directly affects all the others and their ability to move. For this reason, the player gradually conditions his/her fingers in order for each of them to become less and less affected by the movement of others. In this way, the fingers are more and more capable of moving in different directions and working independently from each other, allowing the player to perform complicated passages in the most effective way possible.

In the specific case of the right hand, a concept used by classical guitarists, particularly in fast or involved passages, is that of *finger rotation*. The basic principle of this concept is that no finger is used twice in a row, allowing the finger to take a rest before it has to be used again. This simple idea is then applied to the three playing fingers and thumb (i,m,a and p), and so after a finger plays a note two other fingers and perhaps the thumb will be used before that finger is used again. This is a perfect example of how to distribute the work through all of the fingers and minimize the energy expense and tiredness, allowing the player to concentrate more in the quality of the sound and interpretation rather than on managing to play the music.

This technique became an integral element of my approach to playing, and was learnt more through looking at fingering suggestions on the scores of pieces, than through specific development exercises. Whenever the score to a piece was missing fingering suggestions, or the ones on the page seemed to be lacking in effectiveness, this simple principle solved many difficulties.

## **Tremolo**

One of the disadvantages of plucked instruments as far as sustain is concerned is that any note always starts to fade away as soon as it is played. The maximum volume achieved always occurs immediately after the string is plucked. To create an illusion of sustain, classical guitarists employ the technique of tremolo. A single note is continuously plucked by two or more fingers in succession, allowing the note to continue to be heard at a sustained volume. “Judging from the frustrated attitudes I have encountered on the subject, tremolo is certainly one of the most challenging of techniques. It is an illusion we create - an illusion in which the melody seems to be constantly sustained, although it is not” (Tenant, 1995, p 56).

I used the exercises on Scott Tenant’s *Pumping Nylon* method as well as those on David Oakes’ *Classical and Fingerstyle techniques* in order to develop this technique, practicing them daily and frequently. In my personal case, improvement in this aspect

of playing was very slow, and I found that minimum interruptions in how often I did this practice resulted in a massive loss of work and progress.

This technique is known as one of the most difficult to master amongst classical guitarists. The reason is because, in order to achieve an effective illusion of sustain, there must be an evenness of volume and timing between all the fingers involved in playing the repeated note, and this normally takes a long time to perfect. Guitarists are taught to practice this technique by working very slowly and gradually increasing the tempo, employing exercises that accentuate one of the strokes repeatedly, and in this way concentrating on improving the precision of each stroke. In this technique, the middle finger is usually less efficient than the others in getting its respective timing mastered, and so these accent exercises are particularly important for that finger. “Adding accents is beneficial for uneven tremolo; just listen to yourself and pinpoint what note is weaker than the others, and accent that one” (Tennant, 2006, p. 58).

### **Approaching the repertoire**

In comparison to the vast majority of classical guitar players, I am a relatively unusual case as far as how and when I started in the style, as most classical guitar players start during their childhood or adolescence. I started becoming interested in playing the classical style in my twenties and eventually started studying it seriously at the age of twenty four. To me as a jazz player, the idea of deeply studying such specific techniques for the development and control of tone was unknown. I first started trying to play pieces that were simply too advanced for a novice in the style (even if they are advanced in jazz or other genres), and I did this simply because I thought that my level of playing in jazz and other genres should mean that I shouldn't find it too difficult to play the same instrument in the classical style at an at least intermediate level. A quick look at all the aspects of classical playing mentioned up to now (and later) beyond repertoire learning gives a good idea of how limited my awareness of the style was at that point.

As mentioned earlier, I then began to work on repertoire that was of a more intermediate level, whilst beginning to apply the established technical approaches to the instrument. The first full piece that I learned and was able to perform well (applying the appropriate techniques) was Francisco Tarrega's *Lagrima*. A short piece based largely on moving shapes across the fretboard, this piece is nonetheless a good example of the nuances and sensibilities of the classical guitar, and its Spanish branch in particular. In what I eventually learned was typical of its style, the work makes sophisticated use of a number of aspects particularly idiomatic to the instrument. The work features the guitar's tonal richness, an exploration of the colourful combinations available from the use of open and fretted strings, contrasting registers (spanning E two octaves below middle C, to E three octaves higher) and the shifting tonalities of E major and E minor, both of which are particularly effective key-centres for the guitar.

Whilst working on this piece I applied rest strokes as well as free strokes, looking for a smooth contact between nail, finger and string. I grew and filed my nails to the length and shape indicated both by my tutor and in the instructional books that I was using. In general I used this piece as my first real introduction to playing a classical piece in a way that was as authentic as possible both technically and stylistically, based on my studies to this point.

Following this piece, and those others by Fernando Sor mentioned earlier, I then started working towards more challenging repertoire, gradually incorporating pieces by composers from Europe as well as South America, such as Antonio Lauros' *Vals No.3*, Heitor Villa Lobos' *Prelude No.1*, Enrique Granados' *Spanish Dance No.5*, Isaac Albeniz's *Asturias* and Francisco Tarrega's *Recuerdos de La Alhambra*, among others.

As I extended my exploration of the repertoire I was struck by the amount of work that was needed to perfect each single piece. As I progressed through to longer, more complicated works, I found that it could take several months of practice for a given piece to be perfected, as I concentrated meticulously on several aspects about the performance of the piece beyond the learning and executing of the correct notes.

Many questions arose as part of the learning process: How should I articulate this passage? How should I use dynamics in this section? Where should I use rest strokes and where should I use free strokes? Which fingering should I use on the right hand for this passage? Whilst many indications are often given to the guitarist in the score as far as articulations, dynamics and fingerings are concerned, the player still has many questions of the type above for which to find an answer, by judging the development and expressive intentions suggested in the piece, and interpreting these in the ways he/she thinks are appropriate. Listening to interpretations by other guitarists became a useful tool in this situation.

Whilst players across all genres must surely try to achieve a good performance beyond the basic notes, I had never known of any style of playing which paid such a high level of attention to the analysis, planning and interpretation of the repertoire as I found to be the case with classical music. Coming from a jazz and popular music background, I was able to see parallels between the attention given to tone production in the classical guitar genre, and the application of technology and software in popular music styles.

Many electric guitar players are very specific about the way they process the sound of their instrument through the use of particular amplifiers, the equalisation and effects on them, as well as the use of external effect pedals and sound processing units. A similar level of awareness and control of sound possibilities exists in the classical guitar genre although, in this case, the broad contrasts in sound are purely achieved through the instrument itself. A question could be raised as to what could result from technology-oriented guitarist absorbing the knowledge of classical principles, allowing them to also be able to control the sound, at a deep level, from the very source – the vibration of the strings.

## **The impact of my classical guitar studies on my jazz playing**

### *The single technical approach*

As a student of the classical guitar, I have managed to gain access to valuable information and guidance from the aforementioned books, one-to-one tuition, master classes and instructional videos. The fact that my development has been shaped by many different sources has also been valuable for my research, since it has allowed me to see at first hand the relationship between them, the aspects and methodologies that reappear, as well as those issues and facets that are discussed less frequently, if at all.

In my own practical experience, the main realisation has been that the vast majority of the information and approach to playing that almost all methods offer is overwhelmingly similar, with differences in effectiveness being mostly down to presentation and guidance through the same principles. There is always focus on:

- What posture to adapt in order to have the best possible access to the instrument and avoid any unnecessary tensions and stresses in the body.
- How to use the right hand fingers and nails in order to produce the best possible sound, and variety of sounds, as well as avoid any unnecessary expense of energy.
- How to develop dexterity and independence for the right hand fingers.
- How to develop left hand finger independence, strength, speed, and a strategic use of fingerings that will always seek for the most logical way of playing, avoiding unnecessary energy expense.

With a background studying, practicing and performing jazz and popular music, this has been a major revelation for me. During my previous 12 years of playing experience, I had never encountered such an established and unified way of approaching technique that could be so easily noticeable across the vast majority of available instructional material. At the same time, I had never encountered a style of playing that had so much information available for the development of technique, and that expected so much work in this area from the student.

The vast majority of players in non-classical styles (from my own experience of receiving personal tuition with many different instructors, studying with books, and observing hundreds of players and colleagues through several years) have certain, sometimes many, aspects about their technique which are completely idiosyncratic in that they are conceived and developed independently by the individual players.

Famous examples of such drastically different approaches are found in the work of performers such as Wes Montgomery, who played jazz guitar by plucking almost exclusively with his thumb; Joe Pass, who played with a combination of pick and fingerstyle; John McLaughlin, who incorporated alternate picking with a plectrum in fast lines; Frank Gambale, who utilised a very specific and economical approach to picking (always moving in the direction of the next note/string to be played); Lenny Breau, who incorporated finger picking with a thumb pick, to name a few.

This is, as one might expect, the way in which I too had developed my own technique as a jazz and popular music performer, absorbing different ideas from different players and tutors until finding a combination of my own.

Very occasional tips in areas such as string attack, alternate picking, the development of speed and articulation were provided by a small number of tutors and I incorporated these methods as well. But most of the advanced players who I studied with in the jazz style, as well as those whose instructional books and videos were dedicated exclusively to teaching jazz almost never mentioned technique at all. These include Jeff Schroedl's *Jazz Guitar* method and Larry Coryell's *Larry Coryell's Jazz Guitar (Volumes 1, 2 and 3)*. It was an area of playing that mostly seemed to be left for the student to explore independently, rather than an area where specific instruction was needed.

The universally-accepted techniques that I discovered from my work in the classical style provided a clear set of steps to take which would lead to clear goals and results. I found this approach very effective both for the development of my classical technique as such, as well as for informing the way in which I approach the improvement of my technique more generally.

The sense of cohesion in the teaching and learning of classical guitar throughout the world has arisen for a series of reasons. For example:

- It has developed for a much longer period of time (since its technique can be traced back to the 15<sup>th</sup> and 16<sup>th</sup> centuries, to previous European plucked instruments such as the renaissance guitar, the vihuela and the lute);
- It was the first style of guitar to be accepted and taught in academic institutions, where its technical approach has been designed to find the most optimum use of the arms, fingers and body when playing the instrument;
- Students of the classical guitar are not required to figure out by themselves how to best approach the instrument technically, but have hundreds of year's worth of tested work on the subject at their fingertips.

### **Major benefits**

#### *Left hand strength, independence and stamina*

After working on classical technical principles for the use of the left hand and fingers for a while (such as finger independence exercises, strength development exercises, finger selection techniques and legato exercises), and having applied them to many different pieces of music, I found that my fingers felt more comfortable and relaxed than ever before, particularly when compared to my experience playing jazz and other styles. It caused a dramatic positive improvement in my playing. Prior to studying classical guitar I was able to play most shapes or melodies that I ever desired without any major problems, but now I felt even more at ease at doing so than before. If I had been playing and practicing the classical style recently, the transition to jazz felt like there was almost no effort whatsoever involved as far as the physical aspect of playing. At the same time, my playing stamina increased and I was more comfortable than ever before playing the guitar for long periods, and suffered less from post-performance/practice fatigue in my hands, shoulders and torso.



### *The conscious use of articulations and dynamics*

Through my classical studies, I have also learned about the importance of the technical approach to interpretation. I was aware of devices such as rubato, ritardando, crescendo, decrescendo, tenuto, legato, staccato, and other articulations and dynamic devices, but they seemed to be applied more consciously and meticulously in classical performance when compared with their use in other styles of performance.

In the jazz school, I had studied repertoire mostly through the use of *lead sheets*, as found in the widely-adopted Real Book series. These include the basic chord structures and melodies of the composition, whilst not including any particular directions in terms of the interpretation in arrangement, dynamics or articulation. Lead sheets are designed for the purpose of giving the musician and improviser freedom to take the basic components of the piece and use these as a framework from which they can begin to create their own version and to express themselves through improvisation.

In my experience of other styles, the aforementioned articulation and dynamic shifts were still used, but these mostly occurred spontaneously through improvisation and/or extemporisation. Exceptionally, these aspects would be more explicitly defined within the context of arranged pieces of repertoire for particular bands or for particular performances. In those cases the notated parts of the pieces would have a much more defined arrangement, whilst normally still leaving a great amount of open space for complete spontaneity, usually between a beginning and a recapitulation.

Through my classical studies I have gained a greater awareness of the kinds of articulations and dynamics that could work in a given musical moment, and the ability to maximize that potential. I consider myself to have a much better control than before when introducing dramatic devices into my playing, irrespective of the style of music I am performing; I believe that it is the study of classical guitar that has brought about these developments in my playing.

### *The understanding and use of tone*

All of the above benefits have been highly valuable to me as a player. However, the tonal possibilities I have discovered probably represent the area that has had the biggest impact on my jazz playing.

In the classical school, one is encouraged to look at the guitar with what many usually call an *orchestral approach* or *vision*. Apart from the instrument being able to produce harmonies, this idea stems from the vision that, within the guitar, there is a miniature version of all the multiple colours and timbres available in the orchestra. Depending on the area of the instrument where one plucks, the intensity of the stroke, the angle of the finger and nail, the shape and surface qualities of the nail, and the interaction between the fretting and plucking hands, the varieties of sound and colour available are incredibly diverse.

As I became more and more advanced in my classical studies, I began to discover that these tonal possibilities form the essence of classical technique and are hence studied extensively by classical students. Making the most out of them in the context of musical performance and interpretation is one of the main goals of the classical guitarist and a principal goal of classical technique as a whole.

At the same time as studying these aspects about the classical guitar, I was also creating solo guitar arrangements of jazz pieces, and starting to play certain jazz guitar parts that included harmony and melody with my fingers. At first this work in my jazz playing was completely independent from my classical studies, but, once I started becoming more advanced at using tonal and coloristic techniques, I started to incorporate some of them into the jazz pieces and arrangements that I was playing; this is one of the most significant areas where my understanding of classical technique ended up contributing to my jazz playing.

I understood at this point that the principles of classical guitar tone production are not necessarily based on the specific needs of classical guitar repertoire, or classical music (though that is the genre in which they were first conceived and are usually used). Instead, they are based on a thorough examination and understanding of how

sound is actually produced on the instrument as a whole, at a physical level, and what affects the sound of the instrument in what way. Therefore, the awareness and control over the instrument that derives from this knowledge can actually be used for any purpose, and for any style outside of classical, simply because one will be able to better understand how sound works on the instrument.

### **Aspects of classical technique applied to plectrum-based performance**

It was with the insights described above that I started to experiment with my electric guitar, applying some ideas based on my understanding of tone production into the use of the plectrum in a jazz style. I started to angle the plectrum in a similar way to how I would angle my nails for a basic warm and pure sound – with the outer side at an angle of roughly 40 degrees from the bridge side of the string. I adapted to the plectrum ideas of motion of the fingers as they go through the strings – with a quick stroke that would minimize the noise caused while the finger is in contact with the string, bringing out the actual sound of the note. I also adapted the idea of allowing the wrist to remain straight when in neutral position, thereby avoiding strains.

I was very pleased with the effect that this produced since I was always looking for ways in which to develop a warmer, purer sound. Before I studied the classical guitar, I had managed to achieve what I considered a reasonably good tone in general on the electric guitar, and was not in any way desperate to find ways to improve it. However, ever since I learned the classical tools for sound production, my technique on the jazz guitar, both when in fingerstyle and using a plectrum, has reached a new level of understanding and refinement based on the same principles.

## **Personal work on the jazz style**

### **Initial learning**

I learned to play jazz through a process of absorbing information from several different sources, as well as using my own intuition. This is the way in which the vast majority of jazz guitarists and musicians learn this style. As opposed to the classical style (and with the exception of specific academic courses of study), as far as a shared method is concerned, I discovered that there are no universal specific set of steps that are supposed to be taken by students in order to become jazz musicians. And, perhaps most importantly, there is considerable difference between the ways that many successful and influential players have approached the development of their instrumental technique (such as the previously mentioned examples of Wes Montgomery, Joe Pass, Lenny Breau and others).

At first, I was mostly interested in jazz as an idiom rather than in jazz guitar itself. I would mainly listen to horn players such as Miles Davis, Charlie Parker, Dizzy Gillespie and John Coltrane. My earliest attempts at playing involved listening to records and trying to improvise along with them, as well as without them.

I gradually discovered through trial and error that in order to play jazz, as opposed to blues or other styles that I was used to playing before, I had to undergo an intense phase studying harmony. I sought the guidance of jazz musicians who were able to recommend some good books that I could use and undertook a period of self-directed research. These books would become an important part of my learning. Interestingly, the majority of them were aimed at beginner jazz musicians in general, without being aimed at the performance of any specific instrument. This is an important point to make, since the principles of jazz improvisation (particularly those of melodic improvisation) are relevant to all instrumentalists and are based on the same understanding and mastery of chords, scales and arpeggios, and their application. This allows improvisation and jazz harmony/theory books to be useful and relevant to all learners of the genre.

- **Scott D. Reeves – *Creative Jazz Improvisation* (2007)**

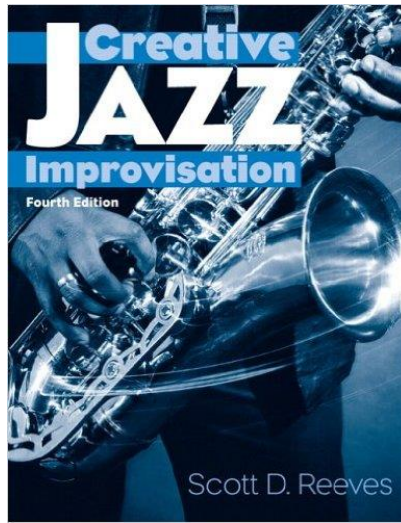

Scott D. Reeves- *Creative Jazz Improvisation* (front cover). Image 51

I consulted this book significantly during the first three years of my jazz studies. It includes transcriptions of solos by many different players, utilizing specific scales, modes and arpeggios. This was particularly helpful as it allowed me to see how the theoretical skills were being used creatively in practice, and how the scales worked over different chords.

My knowledge of the construction of chords also benefitted from this book as it provided examples and exercises on the construction of chords from scales, including extended and altered chords. Chord progressions such as ii V I were also studied in detail and I was able to understand how the ii V harmonic movement formed such an important part of bebop-derived music and jazz composition.

The book also contained additional information related to the understanding of theory, which was helpful for me at the time. This aspect of the book did not involve any playing, but consisted in written exercises which the student was supposed to complete by handwriting. Finally, it included a list of important musicians that jazz players should study.

It must be said, however, that although the book proved incredibly useful over time, at first the fact that it incorporated so many advanced concepts into one title seemed

fairly overwhelming, and the realisation of the sheer amount of intellectual work necessary to master jazz was daunting.

**Jamie Aebersold – *How to Play Jazz and Improvise* (1967)**

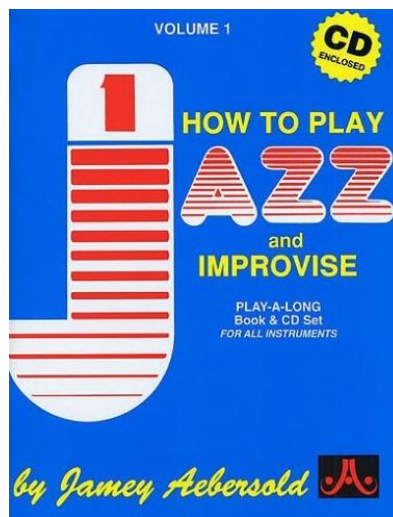

Jamie Aebersold- *How to Play Jazz and Improvise* (front cover). Image 52

This particular jazz improvisation book is one of the best known in its category. Originally published in 1967, I used this book as a reference for scales and chords and their compatibility, as well as for scale exercises. Additionally, I used its backing tracks to practice soloing over different chord sequences, some of them blues-based, and some of them mode-based.

Apart from using the book as a practice resource in the above ways, I also used it as a reference for important pieces and jazz standards to learn and work on. The book includes a list of 'must learn' jazz compositions, as well as including a wider list of all the most famous pieces, organised by jazz sub- genre.

Finally, the book provides guidance on how to develop and shape solos, from the point of view of form, dynamics and tension and release; as well as how to

develop themes and melodic ideas. This kind of information was particularly useful for me as it gave me a push in the direction of thinking more musically about my improvising, rather than let myself be carried away exclusively by the application of harmonic principles.

**Mark Levine- *The Jazz Theory Book* (1995)**

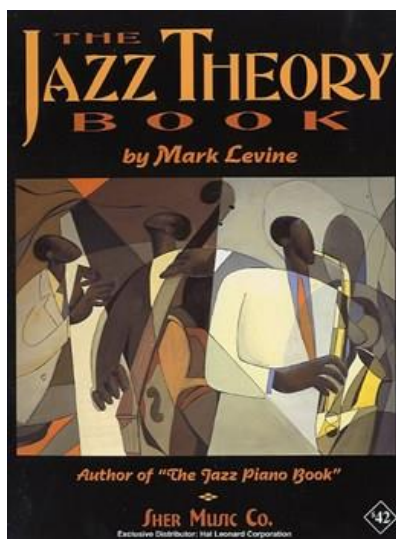

Mark Levine- *The Jazz Theory Book* (front cover). Image 53

I used this particular book to supplement the work I was doing with the other books, as well as my overall jazz learning through lessons, college work, personal practice and live performances.

As the book looks at largely the same basic principles and areas of study that most other reliable jazz theory publications (and teachers/players) do, I mostly used this book to see a different author's version of these principles in order to have a more all-rounded vision of jazz, rather than looking at it from the perspective of a small number of people.

I found its information on harmonic substitutions (such as note-in-common chords, tritone substitution and secondary dominant chords) useful. I also used it

for the purpose of studying the modes of scales such as the melodic minor and the harmonic minor. Given that I purchased this book a little later than the previous two, I was a little more advanced in my studies by this point and was becoming interested in slightly more advanced concepts, such as this.

### **Jeff Shroedl – *Jazz Guitar* (2005)**

This is the only guitar-specific book that I used when learning about the jazz style. It was not recommended by any particular musician or friend, but I simply found it through personal research, and realised that I liked the way in which it explained certain concepts.

I used this book in order to learn certain chord shapes, scale shapes and to practice improvising over a given series of chord changes and pieces.

Shroedl's text also incorporates information about different periods of jazz history, relating them to specific guitar players and playing styles. I found this useful for the purpose of learning how to achieve certain stylistic sound worlds on the instrument. Although my general approach to jazz playing, as suggested by other guitarists and teachers, was through an understanding of the idiom and of harmony as a whole, rather than an instrument-specific approach, this book did help me to translate that knowledge which I was starting to become very familiar with, to my instrument.



***The Real Book – Sixth Edition (2007)***

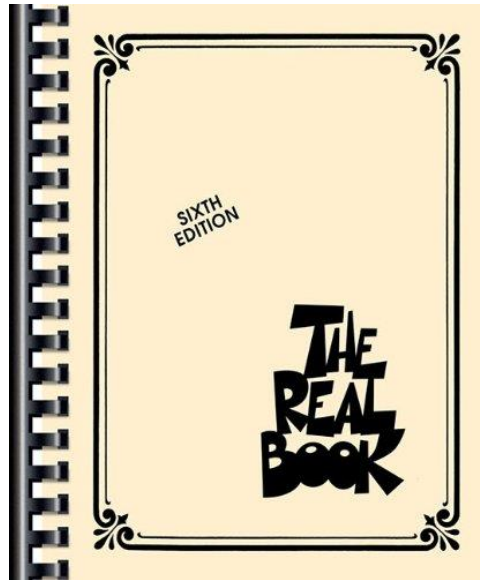

*The Real Book, sixth edition (front cover). Image 54*

Although the Real Book is not a jazz tuition book as such, it was one of the main tools which I used during my jazz learning, and continue to use today as a practice and occasional live performance resource.

It contains a selection of lead sheets for most well known jazz standards, in a well presented, easy-to-read format. I, at different points, have played every single one of the pieces included in the book during practice and live performances. I used it to learn the chords and melodies of pieces, as well as to practice improvising over the chord changes, and to practice my sight-reading.

Apart from this particular book, I have also used other 'Fake Books'. These are essentially books of the same kind, which I have used for the exact same purposes, simply because they included some of the pieces which I wanted to learn and which were not already included in the Real Book.

## **Academic tuition**

Academic education also formed an important part of my jazz learning experience. The first courses I completed were a Level 3 and Level 5 course in music performance at Trafford College, UK. These courses provided its students with a general grounding in music and music performance. However, part of the course content included guitar lessons. During these lessons, my tutor provided me and my peers with information that would advance our guitar skills and challenge our existing knowledge. For most of us (who were used to styles such as blues, funk and rock) this meant a fair amount of jazz and jazz-related skills. We looked at many different scales, modes, arpeggios, advanced chords, jazz lead sheets and improvisation. Receiving guitar lessons at Trafford College played a major part in creating my interest in the jazz genre.

Prior to this, I was used to playing fast melodies in other styles. Early on, having those skills and not being able to get the 'jazz' sound that I would hear in my college tutor's playing and on recordings really intrigued me deeply. The desire to find a way to be able to achieve such sounds in my playing and improvising pushed me in the direction of in-depth jazz study.

I also received instruction in jazz as part of a university degree in music which I completed at Salford University, UK. This particular programme was based on popular music styles, whilst encompassing thorough theoretical instruction and practice. This enabled the student to understand the components of music as applied to any particular contemporary style, as well as providing a general grounding in origins of form, harmony and classical tradition. Although I opted not to receive instrumental instruction during my studies on this course, I received a lot of instruction on jazz harmony and composition during this time, and this understanding informed my guitar skills as much as it contributed to any other aspect of my musical abilities and knowledge.

## **Private lessons**

The third source of guidance in my learning of jazz was that of private lessons, which I attended fortnightly with my tutor and mentor John Harper for over three years. As mentioned previously, he instructed me in both jazz and classical guitar, being an ideal mentor and tutor not only because of his skill as a teacher but because he is one of a limited number of guitarists who I have met who work in both classical and jazz styles at a professional level; this was something to which I was also aspiring.

John taught me to find all the inversions of all chords on the guitar, including extended, altered, diminished, suspended and other chords, and showed me how to use them for chord-melody improvisation and arranging. He also showed me how to build solo arrangements of pieces and trained me to become a better melodic improviser. Apart from receiving lessons with John Harper, I also had a number of lessons with guitarist Mike Walker, who is another well-known player based in the Manchester area who has an established following nationally and internationally. His tuition led me to improve my melodic improvising by working on developing coherent melodic lines through complicated harmonic progressions without changing my playing position, forcing me to change scale and arpeggio shapes as I played, without moving to a different area of the fretboard.

## **Instructional videos and master classes**

Finally, instructional videos and online master classes have also been an important part of my education in jazz. I have utilised instructional material published both on DVD and online by the guitarists including Mike Stern, John Etheridge, Joe Pass, John Scofield, Larry Coryell, Charlie Byrd, John McLaughlin, Tim Miller, John Abercrombie, Frank Gambale, Lee Ritenour, Martin Taylor and Pat Martino.

## **Improvisation and harmonic understanding as priorities in jazz**

As with my work in the classical genre, my personal practice and study of jazz has been a direct influence on this research. That experience, the extensive experience of performing live I thereafter had, and the information which I have analysed for this project, have formed my opinion of what I see as jazz improvisation and self-expression.

There are many sub-genres in jazz, such as swing, bebop, post-bop, hard-bop, free jazz, fusion and so on. Each sub-genre has particular characteristics and frequently features variation in general characteristics such as tempo, instrumentation or harmony, as well as usually representing a time period within the history of jazz. However, of all of these sub-genres there is one in particular which, once mastered and understood well by players, seems to become a kind of proof amongst musicians that they have become competent in the jazz style as a whole, sometimes working almost as a kind of symbolic graduation. This is true of guitar players as well as other instrumentalists (especially melodic improvisers) in jazz. The sub-genre to which I refer is bebop.

The reason for this is because bebop is the style which introduced certain harmonic and rhythmic complexities that were not in use before, and that would become the building blocks of the vast majority of jazz music that came after it – particularly in the harmonic aspect. Apart from that, bebop carried with it the sensibilities of swing, blues, and the early jazz music that came before it. An understanding and practical mastery of the harmonic components of bebop provides one of the fundamental skills that allow jazz players to easily adapt to the demands of any of the other sub-genres of jazz. For me as a learner in jazz, once I became confident playing in the bebop style, I felt that I was comfortable in several different jazz contexts.

Lastly, but just as importantly, is the need for jazz musicians to be both reactive and communicative when playing with one another. On stage, each musician is not only expected to be able to improvise during solo sections but also has the freedom to infuse accompaniment or 'comping' drawing from their own sensibilities in aspects

such as chord voicings, harmonic enhancement, rhythmic patterns and use of space. Decision-making for these aspects is based on listening and responding to the music as it is being played in the moment. All musicians involved in a performance are doing the same thing, each influencing each other's decisions in what becomes an organic process of in-the-moment music making. This judgement and spontaneous decision-making is a way of expression in itself, as each musician's personality is revealed through their reactions and responses.

Each sub-genre and performing style within jazz will have aspects of this. However, some feature it more than others. For example, free jazz often incorporates this ideology to the point of ignoring aspects such as tonality or form, whilst some contemporary styles have very meticulously arranged and notated forms and more limited opportunities for improvisation, yet a great demand on unity, balance and interaction between members of the ensemble.

For me as a musician, the spontaneity aspect of jazz was one that I was able to relate to very easily from the start. After all, the way I began playing the guitar was by ear and by attentively listening and responding to sounds that I heard. From a very early age, and even though I studied violin and piano in a classical way for a few years as a child, I was never afraid of just 'having a go' at instruments and try to join in with musicians in an innocent but fearless way, and as soon as I was a teenager, jamming with friends was something that I did regularly and found very enjoyable. Although the jazz idiom presented many new big challenges, this aspect was one that I not only understood, but felt very excited about. I can see how, if my only experience of music had always been to only play things that I see on the page through a symbol-recognition process, this prospect would have been much more daunting.

## **Aspects of jazz learning and research**

### *Basic scales and modes*

In contrast to the learning approach taken by many jazz players, I did not start by learning about the construction of chords and harmony in the strictest sense. I started by learning scales and trying to improvise with them over static harmonies (one chord) and very simple chord progressions and cadences.

The first scales that I learned were the major scale and the minor pentatonic scales. With these two scales, I played blues and improvised over diatonic music. In these contexts, I improvised over pre-recorded accompaniment using my ears to help me make decisions as far as what exact notes to play from the scales, whilst not yet being particularly aware of I could delineate the harmony with specific arpeggios derived from the same scales.

Having discovered the different modes of the major scale I began to become accustomed to their particular sound, as well as that of the major and minor pentatonic scales; these opened up a whole new world of colours for me. This process in my learning also opened up the whole fretboard, given that prior to this I was used to playing only with one-position scale shapes. I started using these scales as a means of accessing more exotic sounds, for example using the Dorian scale over static minor chords, or the Lydian scale over major chords. Soon after, I also learned about scales such as the melodic minor scale and the harmonic minor scale, as well as the diminished and whole tone scales.

However, as I continued becoming more and more interested in the jazz genre, I soon realised that there were still more sounds that I was listening to in recordings, and hearing in my mind but that I could not yet translate to my instrument with the tools that I had. This would stir me in the direction of learning about arpeggios, and how to reposition them in all areas of the fret-board in order to be able to construct melodies based on the harmony of the music, without having to unnecessarily jump to distant areas on the fret-board as I played. I also gradually learned that these

arpeggios were actually based on selections of notes extracted from the scales that I had already been playing.

## **Getting the Sound**

As far as the feeling of understanding all of the theoretical information but still not being able to create the sounds I heard on records on my instrument, I know that I was not a rare case. Indeed many of my colleagues who have tried to learn jazz have mentioned having similar experiences. In his book *The Ways of the Hand – A Rewritten Account* (also mentioned in other parts of this thesis), David Sudnow also describes his process of learning jazz piano and trying to achieve “the sounds” that he heard on records through an understanding of theoretical information such as scales and arpeggios.

“For a brief course of time while I played rapidly along, a line of melody interweavingly flowed over the duration of several chords, fluently winding about in ways I’d not seen my hands move before, a line of melody whose melodicality wasn’t being expressly done, as in my reiterative attempts to sustain continuity. Somehow, a sequence of notes flowing from one chord’s jazz related ways to the next’s, singing this jazz, was achieved. And it was clear that these ways of interweavingly singing jazz with my fingers, first so difficult to sustain with any satisfying frequency, were the ways of the jazz records” (Sudnow, 2001, p. 77).

Although the instruments are different, many aspects of his description of learning this style are similar to what I personally experienced. “It wasn’t until the start of my third year of playing that I thought of myself as *going for the sounds*” (Sudnow, 2001. P. 40). Personally I took at least three to four years from the point of starting to learn the theoretical principles of jazz to start feeling like I was actually making music that sounded as though it belonged in the same family as the music I heard on jazz records.

This only happened once I was able to associate the theoretical information with my ability to hear sounds and play them on the instrument, as though I could sing through it. This involved a complicated and slow process of study, where I gradually was able to recognise intervals by ear, and then scales and arpeggios, and also play them on the instrument knowing what their sound would be before executing them, or any note combinations derived from them. Like Sudnow, I eventually was able to “take my fingers to places so deeply mindful of what they would sound like that I can sing these piano pitches *at the same time* just as I make contact with the terrain” (Sudnow, 2001. p. 129).

### *Research considerations*

It is interesting that, for the vast majority of jazz players that I know, as well as many of those who I have interviewed, the learning of scales and arpeggios is done for the actual purpose of improvising, rather than as a technical exercise. Whilst many jazz players will run through scales as part of a warm-up routine, the real objective of learning those scales and arpeggios is to actually make music with them, through an understanding of how they fit within the harmonic context of the piece or chord sequence that they might be playing.

On the other hand, as a student and researcher of the classical guitar, I have realised that, whilst scales are indeed an integral part of the study of this style, they are almost always used as a technical exercise that will allow the player to develop certain dexterity at a physical level, allowing for a better accuracy and coordination between the left and right hands, as well as the development of speed.

### *Chords and harmony*

As a student of jazz and guitarist, I first learned chords as shapes on the guitar fretboard and I associated these with a particular name without knowing the theory involved in selecting the notes that made up the shapes. This is common practice amongst guitarists, given that the instrument lends itself to shape-based playing, as chords can be taken to any key by simply moving the same shape to a different area of the fretboard. In this way I learned several different chords from basic major and



minors, to sevenths, extended, altered, diminished, half diminished, suspended, and others.

The visualisation of the harmonic implications of a chord, however, took some more time to master. From learning the basic full shapes of such jazz chords as sevenths, ninths, elevenths, thirteenths, altered and diminished chords, to being able to break them down and take out notes (frequently the fifth or root) in order to strip down the sound to its essential harmonic function.

In this regard, I was able to gradually learn new reduced shapes derived from bigger shapes, with just two-to-three notes included, often incorporating roots, thirds and sevenths; thirds, sevenths and alterations; or thirds, sevenths and extensions, and without any note being doubled or given an octave (as it is often the case with common basic guitar shapes). In a way, this was a (harmonically aware) process of self-tuition of more shapes on what is already a shape-based instrument.

Eventually, partly due to the guidance of my teachers at college, I started to relate these particular chord shapes to scales which I already knew, and slowly started to understand that they were all based on selections of notes from those scales. I could associate them all to a major scale (in some cases having to raise or lower certain notes), or to other minor or modal scales. This realisation allowed me to start seeing the guitar from a different perspective. I could directly connect and link logically the idea of melody with harmony, realising that they both originated from the exact same place, being simply two different applications of the same information.

Understanding this formed the basis of what I would start to practice from this point and during the next years to come as the main priority of my jazz studies – melodically delineating harmonies and chord progressions (often complicated ones, with modulations) based on a knowledge of arpeggios and the notes involved in the chords of the music. These arpeggios and chord awareness would then be unified with the rest of the scales in order to create melodies with ornamentation, as well as a controlled use of tension and release through the use of the remaining, non-chord, notes of the scales, as well as devices such as intervallic melodic construction

(melodies which include large intervals), chromaticism, a creative use of time, and the generation of atonal ideas.

During my personal time studying the classical and jazz genre, I have realised that as opposed to the jazz genre, the classical side and its methods tend to teach certain chords in shapes (predominantly bar –or ‘barre’- chords), whilst never incorporating information about the reasoning, or harmonic function, behind the chords or what notes or degrees from a scale make the chord. They are instead mainly learned because they are often used within compositions, either in their basic shape or as a basic position from which a segment is played, as well as the fact that they develop the strength of the finger and hand due to the barring position which they demand from the index finger.

### *Melodic improvisation*

Continuing with the idea of delineating harmonies, I used the Real Book and other resources to look at jazz standards, learning and memorizing melodies and chord progressions, as well as improvising melodically over their harmony. When improvising there were two main things I needed to understand in order to be able to create my own melodies over any piece:

- Where the modulations were (if any), the keys involved, and what the degrees of the key appeared with each chord.
- What scales/arpeggios I could use and where they were positioned on the guitar.

Unlike the piano, the guitar fretboard has the particularity that each arpeggio and scale will change in its layout depending on the specific area of the fretboard/register in which it is played. This means that, in order to play the same diatonic arpeggio or scale in different areas of the fretboard, the player needs to learn a new shape for each of these different positions.

This presents a challenge for improvisers on the instrument, because in order to play freely throughout the fretboard in any given key, the player effectively has to learn several different shapes. This challenge is compounded where pieces include

modulations as, for each new key the player ideally needs to find a way of moving to the nearest available shape belonging to the new key/scale/arpeggio in order to allow the melodic line to continue to develop coherently and without interruptions. This particular challenge to me meant learning several more shapes for each arpeggio and scale than I had ever known. I found that practicing during improvisation over key changes in the way outlined above proved to be very difficult. In fact I found it so demanding mentally that I devoted several months almost exclusively to the practice of re-positioning of all scales and arpeggios in all areas of the fretboard, limiting myself to this task for the vast majority of my practice time. Overall, this aspect of jazz was the most challenging of all for me, and it took me roughly three years from the time I started to work on these principles before I could use them comfortably and fluently in performance.

Focusing on aspects related to harmony and composition as a basis from which to be able to improvise over moving chords and keys created in me a high level of confidence when it came to analyzing harmony in other musical styles. Having become more confident in my understanding of jazz, I could look at any piece of music and very quickly understand the logic behind the harmony, spot any modulations and key/scale degrees, as well as being able both to play and to break down any of the chords used in its composition.

Once I started learning the classical guitar, this knowledge proved very useful to me, allowing me to understand the intentions of composers from both a harmonic and melodic point of view. Since I could understand it, I was also fascinated to find the ways in which classical composers utilized harmony. As jazz, and jazz guitar, is a relatively new style of music compared to the classical style, it was noticeable to me that composers not only employed complicated chords and harmonies, but also voiced them in ways that were rarely used by jazz guitarists. Whilst jazz guitarists often tend to utilize chord shapes that are comfortable to play and that are easy to transpose to any key, classical composers often utilized more refined voicings that made deliberate use of the unique tonal and textural possibilities of the guitar, often in ways which were only possible for a specific chord in a specific key.

This started to reveal to me the importance of texture and orchestration in classical music, and how it is applied to any setting in the genre. In the case of the guitar, this is an area of significant opportunity, since the instrument is capable of producing several different and contrasting sounds from a tonal perspective, as well as being a harmonic instrument.

### **Chord progressions and the importance of ii V I**

At the very early stages of my jazz playing, I improvised over single chords and, later on, over progressions that included modulations involving two keys, each of which appeared for several bars in the compositions; the chord sequences in Miles Davis' *So What* or John Coltranes' *Impressions* are good examples. Soon after, I started to learn about the importance of the ii V I chord progression, and how it formed a basic building block of the standard songs that underpinned the bebop style of composition, subsequently becoming an important element in the language of most jazz music today.

Practicing soloing over ii V I chords sequences became an important part of my routine. I developed my soloing over ii V I chord progressions focusing on a specific area of the fret board (therefore forcing myself to apply the specific scale and arpeggio shapes that corresponded to that area) and then would do the same in a different area of the neck, until I had covered the entire range of the instrument.

#### *The super locrian/altered scale*

There is an effect in jazz music I will describe as *coherent dissonance* and this involves a sound that suggests great tension and an apparent conflict in tonality, whilst the opposing elements creating an interesting and appealing effect thanks to the existence of a logical and satisfactory transition from tension to release. Although I knew that the use of chromaticism played a part within both jazz improvisation and composition, it wasn't until I learned about the Superlocrian (or Altered) scale and its

application that I was able to unlock the most important source of this 'coherent-dissonance' that I enjoyed very much and was looking for in my own playing.

I first learned about this scale as a mode (specifically the 7<sup>th</sup>) of the melodic minor scale. But it wasn't until later that I discovered how it could be applied to dominant 7<sup>th</sup> chords (particularly those that were altered), before resolving either to the tonic of a key, or, in the case of a secondary dominant, to a non-tonic chord a fifth below/fourth above. I first learned this through the instructional video: *Larry Corryell's Jazz Guitar*. In it, Corryell explains the classical origin of the scale and its application to jazz.

Understanding the application of this scale and its relationship with the altered chords reinforced the fact that chords and scale are directly connected. From this point on, I started to apply this scale extensively over ii V I –based chord progressions with altered V chords, as well as in other circumstances which incorporate altered chords.

### *Sight-reading*

Prior to starting to learn the guitar, I had studied violin and piano and took private lessons in the classical style. As part of these studies I had learned how to read music and to play at an intermediate level by the time I was eleven. My experience of guitar learning started in a self-taught fashion at the age of twelve and it wasn't until six years later, that I decided to take music and guitar playing seriously enough to go to college, where reading musical notation became a necessity. Until this point, I had learned many chords and scales, as well as learning many pieces by ear. However my music reading skills on the guitar were virtually non-existent. Furthermore, after having spent six years without reading any musical notation I realised that I had forgotten almost everything I knew about reading music in general.

At this point I had started to go to college and was being given pieces of music to study at home and this presented a challenge of its own. However, as far as my jazz learning was concerned, I realised that, in order to become a player of a high standard, developing my sight-reading skills was crucial if I was going to be able to study the great amount of essential information that was presented through notated music.

Apart from studying the pieces that they provided me with at college, I started to work through David Oakes' *Music Reading for Guitar - The Complete Method*, a process that took me two years to complete. Working on this book raised my reading skills enormously and, after completing it, I was able to take most jazz standard pieces and either play them on the first run through, or very shortly after.

Interestingly, the classical world and the jazz world have very different approaches and tendencies in this aspect of music, which I discovered later after starting on the classical guitar, and was able to confirm through this research. The jazz guitarist is commonly self-taught, at least for a reasonable amount of time at the early stages of learning, and in some cases completely. For those who read, this skill is usually learned after the guitarist has been playing for a while and, often, at the point at which they have reached an intermediate-to-high standard. This was not only my case but also the case of many of the most influential players in the genre during the last fifty years, such as Mike Stern or Pat Martino. On the other hand, many of the players who were major figures in the decades before could not read, such as Wes Montgomery. For the vast majority of classical guitar players, on the other hand, learning how to read music is an integral part of their playing from the very start.

Going back to the aforementioned book by David Sudnow (*The Ways of the Hand – a Rewritten Account*), I can use his description of the nature of the process of learning to play jazz as a true phenomenon in my own experience. When referring to the way his hands look as he play the piano, after many years of having learned jazz, Sudnow says “It’s as though I were watching an interior part of my body do its business” (2001, p. 1) he later continues “This hand chooses where to go as much as I do” (ibid, p. 2).

In this regard, it is certainly true in my case that, through the intense and lengthy learning process of trying to listen to and recognise complex logic in music, attempting to replicate sounds, mastering theoretical concepts both intellectually and physically, and developing my own personal way of making sense of all of these things; my playing hands (eventually and after many years) move in such a way that it seems that they do it independently from my conscious guidance. It is almost as if

the thinking process was so instinctive and fast that there is no time to consciously recognise what is happening intellectually before it is realised in sound. Clearly for me, the physical considerations of how a hand, at this level of playing, reacts in improvisation to certain sounds/harmonies also involves a certain amount of muscle memory of (in the words of Sudnow) “terrain” that is usually covered when the ears detect a particular harmonic background. Sudnow explains this process “The swing of my hands was at first shored up by thinking. But the instruction is now embodied in the ways of my hand” (2001, p. 128).

## **How my jazz guitar studies have had an impact in my classical playing**

### *Harmonic awareness*

Since jazz playing and improvising requires a thorough understanding of harmony and demands that the player is able quickly to recognise the theoretical origin and components of any given chord sequence, this means that he/she should then be able to apply the same knowledge to any chord progression in the harmonic system, regardless of its genre, as long as the music is based on western harmony.

As a student of the classical guitar, my earlier education in jazz has enabled me to always be aware of the composer’s intentions from a harmonic perspective. I always know where key changes are and what keys are involved, what kinds of chords and scale degrees are being used at all times, and what scales and melodic resources form the basis of the melodies which I am playing and learning.

An example of this is a personal harmonic analysis on Heitor Villa Lobos’ *Prelude N1*, which I give in the video presentation found in Appendix 1. During this demonstration, I break down all sections of the piece to show the various chords, scales, scale degrees and modulations (as well as other harmonic and melodic devices) that are in use in this composition. This would not be possible for me to do if I were only to rely on the skills acquired through learning the classical guitar.

The experience and understanding I have gained as a classical learner with a background in jazz has been incredibly satisfying and enjoyable; I feel that the experience has put me in a good position as an interpreter of a composer's music.

### *Interpretative freedom and spontaneity*

As a jazz player, it is important for me that every performance of a piece of music should involve a sense of uniqueness in terms of the way in which the music develops. In any of the different branches of jazz, in-the-moment expression is one of the key ingredients. Whether it is applied in a particular section of the composition or used as a constant feature from the start to the end of a performance, it always plays a major part in what makes the style exciting and unique. Whether one is soloing or accompanying, one should listen attentively to what the other musicians are doing and respond in the way one feels compliments it best. Even if one is playing in a solo situation, one must allow oneself to listen to the notes that are being produced and respond to them according to the judgment in the moment.

In the classical guitar, particularly when playing solo (which is the most frequent scenario), it is hard to imagine how the same qualities and approach can apply. However, this element also provides an element of uniqueness and freshness from performance to performance in the classical genre. Rather than this being achieved through the use of melodic improvisation, spontaneous re-arrangement of chord voicings or rhythmic patterns during accompaniment, the classical player applies their own interpretation through the application of rubato, dynamics, timbre and articulation.

### *Listening skills*

Listening skills are important for all musicians, irrespective of whether they are required to improvise or not. As a classical student, my personal experience has been that there is some attention given to developing listening skills. However, this is



very often overshadowed by the eminent priority that the style demands from students in the areas of technique, tone and repertoire; listening skills are frequently left out from many students' practice routine and general musical development. This aspect of my research is covered in some detail both within the *Literature Research* and *Interview-based Research* sections of this thesis.

As a teacher I currently teach guitarists at all levels of ability and in different styles, including music from both jazz and classical traditions. This has also allowed me to be the guiding hand when it comes to preparing students for grade examinations. For classical grade examinations there is a listening component. However, this component is usually the very last (and shortest) section to appear in the books devoted to assisting students in their exam preparations; the listening component also represents a smaller proportion of the awardable marks when compared with the other sections of the exam. This, of course, has the potential to impact negatively on the way that guitarists studying in this genre perceive listening skills and the value and importance that they give it.

For a jazz guitarist and for jazz musicians in general, listening skills are the most fundamental of all. Whatever the level of theoretical and harmonic knowledge that a player has acquired, the player still needs to be able to associate a spontaneous melodic phrase that appears in his/her mind with a specific scale, mode or arpeggio in order for it then to be played on the instrument. This cannot be done without well-developed listening skills.

## Conclusion

### **(Proposing a unified technique and how it might affect jazz and classical guitar syllabi in the future)**

*The research has shown general gaps in the knowledge within resources available for the study of each of these styles of guitar playing, and a shared opinion amongst the majority of interviewees that these styles would benefit from improved communication and sharing of each other's understanding of the instrument. In both cases, the expertise developed by the opposite school can help significantly to fill in the gaps in their knowledge. With this in mind I have included a chapter proposing areas of study for guitarists in each style, and how they may affect classical and jazz guitar syllabi in the future.*

## Introduction

I have endeavoured throughout this research project to establish whether there are ways in which the jazz and classical guitar styles can complement each other. In this section I will apply the knowledge I have acquired through the proposal of lessons and areas of study for classical and jazz players that are not frequently given a great amount of attention in their respective educational systems.

These ideas are the result of a growing understanding of these genres and the opportunities that they offer, and represent the gaps found through the research in existing instructional material, as well as those areas mentioned by the players interviewed themselves to be generally lacking in the current education of players in the jazz and classical guitar styles.

The purpose of this section is not to transform players from one genre into another, nor to make them equally advanced at both, but to present them with a range of techniques and possibilities that will help them to become better users of their instrument based on a more complete understanding of it, what it offers, and its behaviour. Likewise, the intention is not to underestimate the importance of the areas

of technique and knowledge which are currently well covered by most educational resources in either style, but to complement them. Finally, it is important to mention that this proposal is aimed particularly at those individuals interested in the further and future development of the guitar and our understanding of it, rather than those mostly interested in its traditional practice.

I want to emphasize that this section's aim is to explain the reasoning behind certain techniques and exercises just as much as it is to provide the exercises themselves because I believe that, as I frequently find with my students (and myself), this approach tends to cause a completely different feeling in the learner than going straight into exercises does. It reveals opportunities which were perhaps previously unnoticed, and tells us where we are going and **why** we are going there, before we set in motion, usually resulting in a bigger personal enthusiasm from the learner to succeed. Additionally, it helps develop a critical and analytical approach to the player's practice, rather than a very passive or mechanical one.

### **Identifying a series of important classically-derived advances to inform jazz playing and plectrum technique**

History tells us that there have already been a number of well known jazz players to have ripped benefits from the study of classical technique. Charlie Byrd, Luiz Bonfá, Lenny Breau, Ralph Towner and Martin Taylor are just some of these individuals who have all done it in different ways and to different extents, some of them fully embracing the whole technical approach (such as Towner and Byrd), and some just being influenced by it in aspects such as posture (Taylor) or left hand technique (Breau).

Nonetheless, the greatest majority of jazz players do not adopt knowledge as derived from classical technique to their playing. This is not surprising given that, as described in the thesis, very little advice on technique (of any kind) is usually provided within jazz guitar instructional material, particularly when compared to equivalent material for the classical guitar.

As described in the literature review section, although much of the instructional material for classical guitar does not explain the reasoning behind techniques, the guidance on how to develop technically as a player is abundant in almost every single case. Interestingly, although physical considerations are given great attention, the origin of the classical guitar technique for plucking the strings is based on the quality of tone, before the efficient use of the hands or body “Tone is the number one thing a classical guitarist should focus on” (Morris, 2013).

The following pages provide a proposal for the understanding of how sound is produced on the guitar and, through this understanding, the control of the quality of that sound. This is as derived from classical syllabi and instructional material. Nonetheless, it considers the guitar and its behaviour as an instrument from an open perspective, not regarding any necessities or demands from any specific style, making the application of this knowledge relevant to the production of any desired sound.

Although this section is designed to explain many of the most important classical guitar principles and ways for jazz and plectrum guitarists to benefit from them, its priority is to bring these styles closer and not to simply (nor fully) teach the classical guitar, so it should not be interpreted as a complete classical guitar method.

## **LESSON 1 – Basics of sound production and sound quality**

The sound of the guitar originates with the vibrations of the strings, whether the instrument is acoustic or electric. These vibrations are then amplified in different ways in each case. However, in both cases, the characteristics of these vibrations will influence the final sound of the instrument. Similarly to sound recording, amplification and effects can certainly affect the sound in countless different (at times beneficial) ways, but are not able to change the original quality of the source. Therefore everything we do (good or bad) that has an effect on the vibration of the strings, or the pre-amplified characteristics of the sound, will consequently be amplified. This can be experienced by playing a semi-acoustic electric guitar and comparing it to a

solid body amplifying both with the same settings and equipment; by playing with a .60 mm plectrum and comparing it to a 1.0mm one; by playing the guitar with the fingers as opposed to a plectrum; or by playing close to the instrument's bridge as opposed to close to the neck. All of these qualities are pre-amplification characteristics of the sound which are then being amplified with the equipment.

### *General outlook*

As guitarists, we want to be able to use the natural characteristics of the instrument's response and behaviour to our advantage and maximize their potential, refining the quality of that original source of sound as much as possible, consciously making the most of what the instrument is physically able to offer us as far as sound quality and projection. This is the central core of classical guitar technique, and something that players, students and scholars in that style spend huge amounts of their working lives investigating and refining.

### *The motion of the guitar string relative to the sound hole/pickups*

The guitar's strings vibrate between two fixed points when they are played: the bridge and the nut. They can vibrate sideways, or up and down, depending on how they are stroked. The way in which most people usually and instinctively tend to stroke the strings (either with the fingers or with a plectrum) is sideways. This then causes the string accordingly to vibrate predominantly sideways.

*With an acoustic guitar to start, try plucking the G and D strings, individually, perfectly sideways with your finger, getting them to vibrate as in the example below. Make sure that the surface of your nail is parallel to the string, and that you are not pulling the string up. Listen very carefully to the sound:*

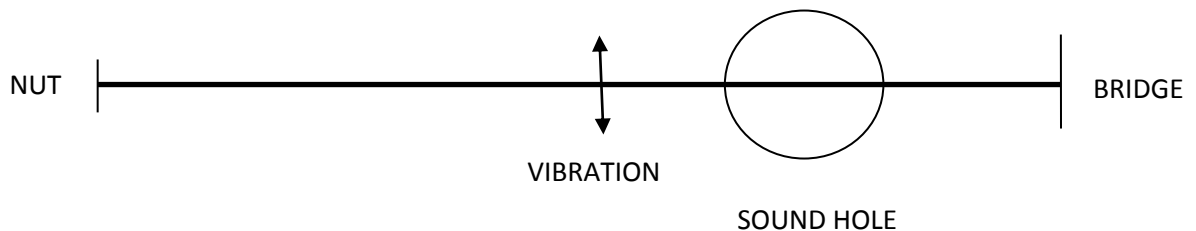

Image 55

Classical guitarists, however, tend to develop a technique with which they try to get the string to vibrate up and down, more so than sideways. (There are also many other considerations beyond this to get an authentic classical stroke and sound, which we will look at later).

*Now very attentively try plucking the G and D strings down (individually) with your finger skin, getting them to vibrate as in the example below. You should keep your finger straight and push the string down, then releasing it to vibrate up and down. Listen carefully:*

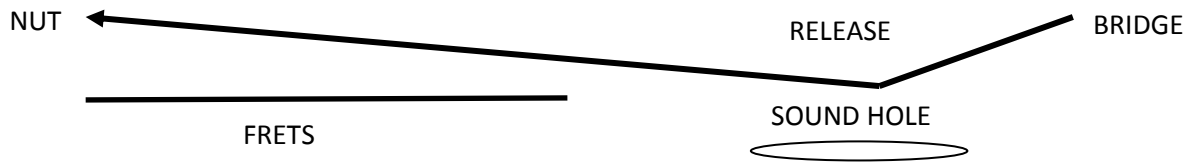

Image 56

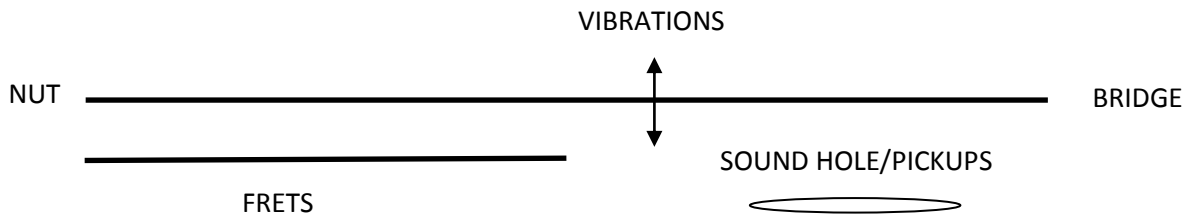

Image 57

*Now we will compare them. Try playing and listening to the two approaches (sideways, and up and down) whilst very lightly resting the tips of the fingers of your other hand close to the bridge of the guitar. If you do this carefully and with equivalent force in both stroke types, you should feel considerably more vibration and depth of sound on the downwards stroke.*

The physics and mathematics of how a guitar operates are very interesting and deserve an in-depth study of their own. However, the basic reasoning behind this technique and its effectiveness can be understood by looking at the basics of the way the acoustic guitar is amplified.

In the broadest of terms, sound is created when vibrations in objects are transferred to the air, changing its pressure. These changes in pressure create waves in the air. If the change in pressure is sufficiently large, the waves, when reaching us, will affect

tiny hairs and bones inside our ears, becoming what we then perceive as sound. The string's vibrations produce the sound of the instrument. However, the strings' vibrations alone are barely audible to us, as they affect/change the pressure of the air around it very little. To make them noticeable, they need to be transferred to larger surfaces.

These larger surfaces are provided by the rest of the guitar as a whole, in particular the upper plate of the body (which on an acoustic guitar is very thin and therefore highly susceptible to vibration). The strings are attached to the bridge, and the bridge to the upper plate. Therefore, if the strings vibrate up and down, so does the bridge, and also the upper plate (this is why the previous exercise indicates that we should lightly touch the area close to the bridge as we play), agitating the air around it more and thus helping to transmit those pressure changes to our ears. If the strings vibrate sideways, their vibrations are not transferred through the bridge to the upper plate and the rest of the instrument in the same way, as the rest of the instrument is ***underneath*** the strings, as opposed to on one side of it. The sound hole also plays an important role for the reason that, when the vibrations are transmitted through the guitar and gathered at the bottom plate, they are then largely sent out through that hole.

### *Electric guitar applications*

Interestingly, these principles also have a noticeable effect on the sound of the electric guitar, and we are also able to reach for a richer sound by applying them. This is demonstrated in the instructional DVD (Appendix 1) that accompanies this material.

*Carefully try the above exercises from lesson 1 on an electric guitar with a clean sound. Provided you follow all indicated steps closely, you should notice the difference. Make sure you have enough volume on the amplifier so that the unamplified natural sound of the instrument doesn't have an effect on your judgment. Also be reminded that, with the lessons to follow, more important information will be introduced which will be vital to get the sound quality that we are ultimately after.*



## LESSON 2: How classical guitarists achieve the downwards stroke

Apart from the requirement of making the strings vibrate up and down, the classical approach to the Downwards Stroke has a series of specific procedures designed to make it natural to play, as well as to get the most refined sound out of the instrument. These procedures can be separated into two categories:

- *Nail considerations*
- *Movement considerations*

### *Nail considerations*

The plucking nails need to have a specific shape and length in order to help the *Movement Considerations* to work properly later. They should be just long enough so that if the player touches a flat surface with the end of his finger (creating a 90 degree angle between finger and surface), the nail has the same length as the end of the finger.

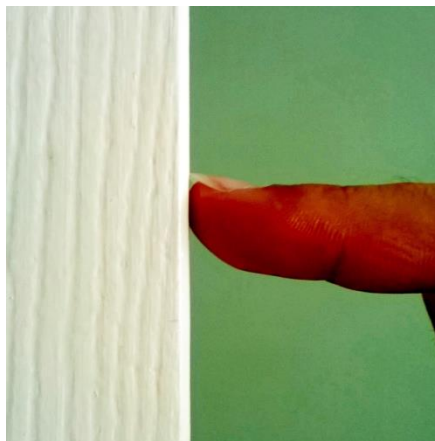

Plucking hand nail length. Image 58

Their shape should create a ramp that allows them to travel past the string easily, whilst pushing it downwards (making it vibrate up and down). If the player looks at the upper side of his/her hand whilst stretching the fingers, this nail shape should increase in length steadily from left to right, starting with minimum length, with no

corners or points –creating a smooth ascending shape, and reaching its highest point roughly  $\frac{3}{4}$  of the way to the other side. From this point it should descend rapidly and smoothly until reaching the other end.



Plucking hand nail shape. Image 59

Although the vast majority of players follow these guidelines, there are occasional slight variations of these nail shapes that some players use (for example slightly longer nails). This is partly because nail characteristics in natural shape and thickness can vary from person to person. However their principles remain the same as far as creating a smooth ramp to pluck and push the string down, facilitating the downwards stroke.

Apart from shaping the nails, the player should then smooth and polish their surface thoroughly using common nail conditioning equipment. The goal is to make them as smooth as possible in order to avoid any unnecessary impurity in the sound, which can be caused during strokes by rough surfaces making contact with the string.

#### *Movement considerations*

First, we need to place the plucking hand in the correct neutral position. To do this, we need to lightly rest the thumb (p) on the sixth or fifth string, the index (i) on the third string, the middle finger (m) on the second string, and the ring finger (a), on the

first string. The thumb should be to the left hand side of the fingers from the point of view of the player.



Neutral position for plucking hand. Image 60

The movement of the fingers needs to originate from the main joint in the hand. This will allow each finger to make the best use of its strength. We shouldn't move the second or third joints beyond the small natural movement that will occur after attacking the string, and we shouldn't pull the string upwards. The string should be stroked with the left side of the fingertip, from the perspective of the player, roughly at the point where the end of the finger nail meets the skin, as shown below.



Right hand plucking– angle and contact specifications. Image 61

As we stroke, the string should then move down swiftly following the ramp which the nail shape creates, whilst being pushed down to continue vibrating perpendicularly to the surface of the upper plate – effectively transmitting its vibrations to the bridge and the rest of the instrument. All of these principles are then applied in two kinds of stroke:

### *Free stroke*

The free stroke consists of playing the string and then allowing the finger to move past it until reaching a natural stop in the air. This is the most useful and frequent stroke and is perfect for arpeggio-based playing, as well as playing that requires certain notes to ring as others are being played.

### *Rest stroke*

The rest stroke is used mainly to play single melodies. It consists of the finger playing the string and then immediately resting against the next lower string. This stroke is based on the idea that, in this way, the finger can approach the string with greater force and without concern for the adjacent string, which will be dampened as the finger rests on it. In this way single melodic lines can have more presence.

*Try playing the following example of the kind of passage that would be suitable for free strokes. This passage should be played with all notes ringing out indefinitely until the bar changes:*



Image 62

*Now try playing the following example of the kind of passage that would be suitable for rest strokes:*



Image 63

### **LESSON 3- Long-term tone development and noise reduction**

In the classical style, the concepts of tone production and their application are learned and then improved over time. The idea is to continue to refine the quality of the sound indefinitely, not only through practical experience of playing repertoire, but through extensive work and continuous critical listening into that specific aspect of playing.

Apart from the note that is produced by the string's vibration, the contact of the finger and nail (or plectrum, as it also applies) with the string also inevitably makes a sound. This is simply the noise from the nail/finger/plectrum's contact and friction with the nylon or steel of the string. In the continuous quest for improvement in sound, we aim to reduce this noise to make the sound of the actual note more prominent and pure. In order to do so, we aim for two main things:

#### *Quick contact*

We want to get the finger/plectrum to stroke the string with the principles we have learned, but get past it as quickly as possible in order to reduce the noise. To train the fingers to do this, many classical players practice what they call the *follow-through* approach. It is based on the fingers playing the string and continuing to move all the way into the palm of the hand, all in one fast stroke. In this way, the finger achieves a speed of movement faster than it would if it was only supposed to travel as far as the string is located, and then pluck it/pick it.

#### *Limited contact*

Applying the principles just explained will already provide some of the effect desired with this aspect of technique. However, once explained, the player can continue to practice and refine it. The amount of nail surface area touching the string will also have an effect on the amount of noise that will be produced when plucking. For this reason, we want to have the necessary contact with the string that will allow us to produce the downwards stroke, but not exceeding that amount.

For example, when playing a string with our nails (or plectrum) completely parallel to the string, a much larger surface area is likely to contact the string, pulling it until eventually the string will give in and snap, creating considerably more noise than is desirable. The nail ramp and angle learned previously help significantly in this matter. However, as we make progress with the acquisition of these techniques, we should monitor our strokes to make sure that we are constantly improving their efficiency.

I start my daily practice with the idea of tone refinement in mind, whether I am playing the jazz or classical guitar (even though I learned these principles from the classical school). I like to think that making the sound quality of the single note as good as possible is a good place to start when playing or practicing any music.

*Try playing single open notes for five minutes as part of your warm up routine. Aim for a quick stroke (keep the follow-through ideas in mind), and aim for the minimum contact necessary for good tone. Repeat each note several times, chose a slow tempo and play in time.(Remember, all concepts explained are applicable to any surface being used to play the strings, including the plectrum).*

#### **LESSON 4- Avoiding unnecessary restrictions in the functioning of the upper limbs (blood flow and musculoskeletal considerations)**

As guitarists, we demand a lot of work from our upper limbs. Their use is necessary for everything that we do with the instrument. As a school, the classical guitar is greatly concerned with the efficient use of the instrument, as well as the efficient use of our body. For our limbs to work as well as possible, as well as to tolerate longer playing sessions without problems, we should avoid any unnecessary positions that limit or restrict free blood flow and the optimum functioning of tendons, joints and muscles.

The most common examples of these habits are the bending of the wrist on the right/plucking hand, as well as the exaggerated bending of the left wrist when playing fretted notes.



Example of habits which restrict the optimum functioning of the upper limbs – bent wrists. Image 64

Therefore we should aim for straight wrists that will facilitate the efficient use of our upper limbs, both on the right and left hands, allowing us to play more efficiently for longer.

### **LESSON 5 – Considerations of the axial skeleton (posture and its effect on efficient performance)**

As can be seen in the demonstrations DVD (Appendix 1) which accompanies this material, there is no universal posture that all jazz guitarists use. Interestingly, since the classical style is greatly concerned with the most effective use of the instrument and body, posture is a major subject in that style. My intention is not to suggest that jazz players should apply the exact same posture (although that works for certain individuals – famously Martin Taylor and Ralph Towner, for example) but to consider seriously the real consequences of posture.

As musicians who dedicate large amounts of time and energy to our instrument, we have to think long term, and we have to think how we can better use our bodies in order to be able to play for as long as possible in the upcoming years and decades. During the interview-based research phase of this thesis, it was interesting to hear what guitarist and tutor Jim Faulkner had to say about this issue. Faulkner is a jazz

guitarist and teacher at Chetham's, one of Manchester's most highly regarded music schools. However (as stated in the interview section), he began as a classical guitarist, and as a teacher he also teaches jazz as a second study to classical players. Thus he has extensive experience of teaching both kinds of guitarists, and it is noteworthy that he mentioned seeing far more injuries produced by posture-related problems amongst jazz guitarists than he does with classical players.

Additionally, after becoming a jazz guitarist and ignoring classical posture for a long time, Faulkner himself suffered a serious injury which he expected to cause him to stop playing altogether. However, upon seeing a specialist doctor, he was advised to hold the instrument in a way that, coincidentally, was very similar to that of a classical guitarist.

When we play the guitar, it is easy to get completely absorbed by what is happening with our hands and fingers and forget the rest of our bodies. Often the consequences of good or bad posture cannot be noticed until years later, when we either experience significant injuries or find ourselves free from them. I personally noticed increased relaxation in my playing after a couple of years learning the classical guitar and its posture. Even if we don't apply it in exactly the same way, taking into account its principles can be beneficial, especially in the long term.





Traditional classical posture (Image of Andres Segovia).

Image 65

There are also occasional contemporary variations of this basic posture which still keep in mind the same basic principles and , as mentioned previously, benefitting from them does not necessarily mean copying classical posture identically, but using it as a guideline. The main concepts deriving from the classical approach to posture which can be easily transferred to other styles of guitar performance, including jazz are:

- Keeping a straight back
- Avoiding raising the shoulders (creating tension)
- Keeping the lower limbs completely relaxed.
- Stabilising the guitar by raising one leg with a footstool. Traditionally classical players will do this with the left leg. However, the instrument can also be stabilised by raising the right leg.
- Monitoring and avoiding tension anywhere in the body. We are looking for a complete state of relaxation.

- Monitoring breathing in order to achieve complete relaxation. Breathing in and out in interrupted patterns and varying speeds will work against complete relaxation. On the other hand, breathing in just the right amount of oxygen in order to achieve the task at hand, without exceeding it, is good, particularly at steady rhythms. Stress and tension consume energy, and we don't want to facilitate these states.

## **LESSON 6 – Efficient note transition (preparing the fingers for the next note)**

So far we have considered many things related to the right hand, as well as overall posture. The classical guitar school also has a series of principles to help maximize the efficiency in the use of the left hand. One of the most important ones is a very simple concept – *As soon as a note is played, start moving towards the next note with the required finger. Don't wait any longer.*

Although it is a very simple concept, most guitarists don't naturally do this (or at least don't consciously maximize its potential) until advised to do so by someone else. I didn't until my tutor suggested it to me, when he mentioned that he had been advised to do this by legendary guitarist John Williams himself – with whom he had had a series of lessons. In my personal experience and that of my teacher and students, this can significantly help to achieve great flow and continuity in phrasing if practiced frequently and incorporated into regular playing. Of course this can be applied to any style of playing.

*Try playing the following G major scale in second position whilst moving the necessary left hand fingers towards the next note **as soon as** any given note is played. Play very slowly and watch your fingers as they move:*

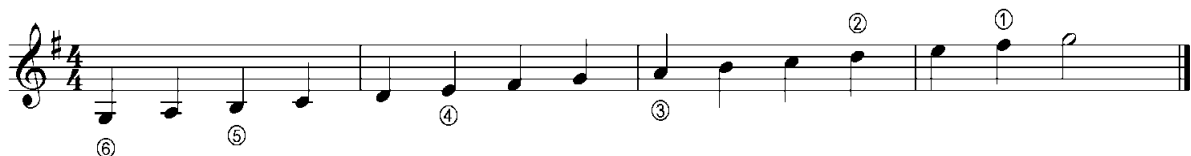

Image 66

## **LESSON 7- The thumb paradox (avoiding unnecessary resistance in the movement of the left hand)**

In my experience, this is a controversial area amongst guitarists. Many think you can only do certain things if the thumb plays bass notes whilst the fingers play higher notes. Others (certainly those who come from the classical school) are told from the very early stages that doing this will restrict their movement. I personally think that there are benefits available from both. However, I must admit that in most cases when I have seen a player using the thumb on the fretboard, it was to play something which just as easily could have been done without recourse to this. Of course, the sound produced can nevertheless be effective anyway. But for the sake of discussing the most effective ways in which we can potentially approach our instrument, let's consider that we can use whichever is most effective, and consumes less energy, depending on the task at hand.

If, after thorough analysis, there is simply no other way in which we can physically play a chord shape, the thumb over the fretboard should, and must, be used. However, in all other situations, we can benefit the flow of the musical passage by facilitating the greatest amount of mobility on the left hand. In order to do this, we want to avoid resistance and friction between the hand and neck. The greater the surface area of the left hand touching the neck of the instrument, the greater the resultant friction, and thus the greater amount of energy required to slide up and down its surface. For this reason, the classical school suggests touching the neck of the guitar only with the tips of the fingers at the front, and with the thumb on the

middle of the back of the neck (the only exception being bar chords, when the index finger is laid flat, pressing several strings down at once).



Left hand posture – touching the strings only with the tips of the fingers. Image 67



Left hand posture – touching the back of the neck with the thumb only (using the joint as the pressure point). Image 68

As we place the thumb on the back of the neck of the instrument it is also vital to know that, for the purpose of greater mobility and resistance minimisation, the pressure point between the neck and thumb must be the second thumb crease (that which is closest to its nail). In this way, the movement of the hand between positions will be much easier than if the contact with the wood is made with the section of the thumb above the joint (behind the nail).

*Try moving your left hand up and down the guitar neck (without touching any strings at the front) whilst using the tender skin area behind the base of the thumb nail as a pressure/contact point between the thumb and the back of the fretboard. Then try the same whilst using the second joint crease (that which is closest to the nail) as the pressure point. You should feel considerably less resistance in this way.*

Interestingly, some guitarists are of the opinion that using the thumb, as opposed to other parts of the hand behind the fretboard, also allows the player to apply his/her hand's strength more effectively and comfortably. *Try squeezing a small object between the tips of your fingers and the palm of your hand. And then try the same between the tips of your fingers and your thumb (as with classical posture).*



Hand strength application, example 1. Image 69



Hand strength application, example 2. Image 70

### **LESSON 8 – Extrapolating classical left hand thumb/finger balance and applying it to right hand plectrum performance in jazz**

As we could see in the previous chapter, classical technique achieves a balance in the left hand through the use of the thumb joint and the finger tips as the contact points between the hand and the guitar. This allows the hand to use its strength most efficiently as well as allowing it to move between positions along the fretboard with the least amount of resistance possible. The same basic concept of balance can also be applied to the right hand plectrum style of playing, for the purpose of achieving equilibrium of force between the thumb and the fingers.

There are many ways in which plectrum style jazz (and other) players hold their plectrums – many of which are demonstrated in the DVD provided with this thesis. As there is no universal way in which all, or most, players are taught to hold the plectrum, nor one which is widely regarded as being the best, many idiosyncrasies have emerged amongst highly renowned players which have allowed them to develop efficient technique. Renowned progressive rock guitarist Robert Fripp, however (whose achievements as a producer and visionary of sound are as influential as his guitar playing) is acknowledged with bringing forward this extrapolation of the principles of balance of the classical left hand technique to the plectrum-style right hand.

Most other common techniques involve holding the plectrum between the thumb and one of the fingers with different points actually being used as contact points. Since the thumb is naturally stronger than any one finger, when using alternate picking, this results in a very well supported downstroke (supported by the thumb) and a less well supported upstroke (supported by a single finger) – Please note that during this section the term ‘downstroke’ will refer to the downwards execution of a string with a plectrum, rather than the movement of a string towards the soundhole achieved with the fingers in the classical style through the ‘downward stroke’ mentioned in previous chapters. Unlike most, the technique used by Fripp finds a way of compensating for this lack of balance. He does this by bringing all fingers together and aligning them with the index as this takes the job of holding the plectrum on the side of its first crease (from the nail) against the thumb’s first crease (from the nail), as can be seen in the image below.



Plectrum technique - supporting upstrokes with four fingers. Image 71

By using this hand posture, the player’s alternate picking will not be constantly affected by a considerable difference in energy expense between downward strokes and upward strokes, providing more efficient balance and playing stamina.

*Try playing any scale whilst applying this technique, and then repeat it whilst holding the plectrum between the thumb and one finger, leaving all other fingers loose. Although you will be unaccustomed to the new posture (assuming you haven't used it before), you will notice that the hand feels lighter as you move it upwards, as all fingers work together to prepare it for the next down stroke.*

### ***Volume and tone considerations as affected by the pressure point.***

The amount of pressure applied to the plectrum when holding it will also have consequences in sound as it strokes the string. A greater amount of pressure will automatically create more resistance between plectrum and string when stroking (since the plectrum will not be able to rotate backwards as easily when hitting the string, allowing to move past it), requiring greater force to get past the string, and hence causing the string to move more when vibrating, producing greater volume. An awareness of this effect will create greater control of volume in an alternative way other than simply hitting the string harder.

## **LESSON 9 – The application of classical rest and free (or 'open') strokes to plectrum technique**

As explained in lesson 2, classical guitarists have two different ways of plucking the strings: the rest stroke and the free (or 'open') stroke. The way in which the vast majority of plectrum guitarists play is the equivalent of the classical player's free stroke. This is in the sense that the string is executed and the plectrum then continues to move in through the air past the string. The rest stroke, on the other hand, is done by plucking the string in such a way that the finger then lands and 'rests' on the next string, finishing its movement at this point.

Classical guitarists use the rest stroke for single line melodic playing almost exclusively. This is because, as the finger rests on the adjacent string immediately after plucking, it would stop that string from vibrating/ringing in a situation such as



arpeggio-based playing or chord playing (where different strings are required to vibrate together after being plucked). In these circumstances, the free stroke is much more effective.

Nonetheless, when the requirements for the vibrations of the strings are not an obstacle, many classical guitarists consider the rest stroke to be particularly beautiful for single line melodic passages “A rest stroke is generally considered to be fuller sounding than a free stroke” (Tenant, 2006). This is because the principles of vibration explained in Lesson 1 with the ‘downward stroke’ are exploited to the fullest, as Tenant explains “What a rest stroke really does is set the string vibrating more in the direction of the soundboard. Physically, this results in more resonance inside the guitar and on the soundboard itself”.

Plectrum players usually incorporate a combination of down and upstrokes into their playing, since this allows them to play twice as many notes in any given melodic passage with the same amount of up and down movement of the hand, this is commonly known as alternate picking. “The general behind alternate picking is: whenever you do a downstroke, rather than following it with another downstroke, you use that upward motion that your hand is doing in between the two downstroke, and play another note with that” (Govan, 2015).

As previously described, the rest stroke augments the effect of the ‘downwards stroke’ explained in lesson 1 and demonstrated on the DVD that accompanies this thesis. It can also be applied to the plectrum style of playing for the same effect.

*Try playing a scale of your choice with a plectrum with rest strokes.*

*Make sure that you don't allow too much of the plectrum to make contact with the played string, as this will create more resistance and make the stroke harder to achieve, impairing the sound. Also make sure you approach the string with your plectrum at roughly 120 to 140 degrees from the upper surface of the guitar body (with the tip of the plectrum looking slightly towards you).*

The nature of the angle of the plectrum required to produce a good rest stroke makes it very difficult to generate rest strokes in an alternate fashion at a speed equivalent to that achievable with free-stroke alternate picking (since the rotation of the plectrum for down and up rest stroke angles demands much greater energy than alternate picking in a free stroke fashion). Classical players solve this problem by using two different fingers -usually 'i' (the index finger) and 'm' (the middle finger)- and alternating them, allowing them to play much faster rest stroke-based melodic lines. For practical purposes, non-finger style guitarists can benefit from the simple knowledge that the richness of sound of a rest stroke is at their fingertips, even if its application to fast runs is less practical in a plectrum style. It can be used to emphasize the beauty of melodic passages, as demonstrated by the example above, or even to simply emphasize certain single notes within a passage.

## **LESSON 10 – Legato practice, finger strength and independence**

The left hand fingers in the classical style are required to move independently from one another in order to play different moving lines simultaneously, which also often require big stretches. Apart from this, legato is a very common form of articulation which is based on executing two or more consecutive notes with one stroke, and its use requires more energy from the left hand fingers than the usual stroke does. Using these techniques strengthens the fingers and conditions them to be highly efficient in their movement. Incorporating these concepts into daily practice routines can be highly beneficial for anyone looking to further-improve their left hand finger efficiency. It can be, for example, very helpful for gaining great facility playing solo arrangements in jazz or complicated chord shapes.

Try the following exercise for finger independence.

Place your fingers in 5<sup>th</sup> position, on the third string, aligned as in the picture below.

Lightly rest your fingers on the string, without pressing it down:

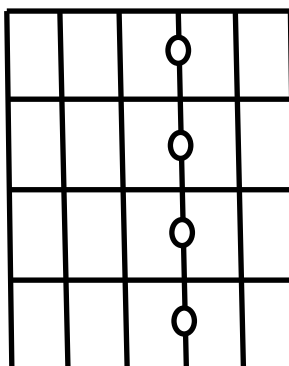

Image 72

Now move the fingers represented by black dots in the following way (whilst keeping all other fingers resting on - not pressing - the third string):

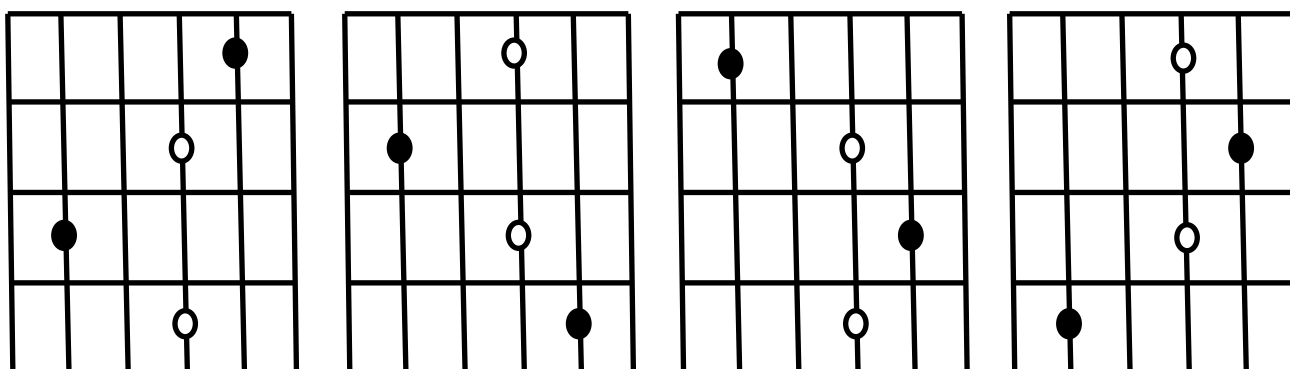

Image 73

Try the following exercise for legato technique:

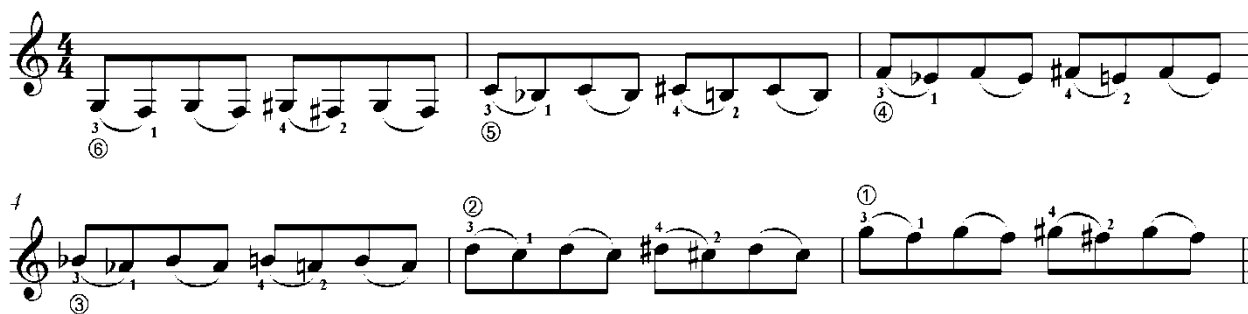

Image 74

## LESSON 11 – Embracing the guitar’s unique possibilities (expanding horizons in harmony and tone colours)

Jazz guitar learning often encourages us to look to other instruments in order to learn how to create melodies and approach harmony in the style, for example listening to and transcribing saxophone or trumpet melodies and playing them on the guitar in order to learn about melodic phrasing and its relationship to the harmony; or listening to the piano for the purpose of learning about comping and voicing chords in interesting ways. This is all very helpful indeed, and I personally have certainly benefitted from it as well. However, we don’t tend to find an equivalent amount of information related to the guitar’s unique possibilities as far as tone colour and harmonic expression.

As an instrument, the guitar (unlike the trumpet or piano) has the opportunity to play many notes on different strings and in different areas of the fingerboard. Each of these different versions of each note produces a slightly different sound in terms of tone colour. Additionally, our instrument has the possibility of playing six open strings, which again produce a different sound. These different options and their

combinations can produce a vast number of possibilities when it comes to voicings. Certain chords can have a unique voicing on the instrument.

*For example, take the following Am9 chord and play it in a common (moveable) position:*



Image 75

*Now play it in the following position, using a combination of open and fretted notes that cannot be reproduced in any other key on the instrument (unless the guitar is tuned differently):*



Image 76

*Listen to the particular character the chord has when open strings are incorporated, and compare the two sounds.*

As with classical music itself, classical guitar composition has amongst its priorities the complete use of the possibilities of the instrument, not just as far as range but in terms of sound and colour. So, idiomatic voicings like the one shown above are much more frequently found in this style. Looking at classical guitar repertoire reveals great

opportunities in this respect which might be difficult to find in the same way in a different style.

*Play the following voicings taken from classical guitar repertoire. Listen to their character and colour and compare them to the ones frequently found in books about jazz and other guitar styles:*





				
F#7b5b9	E Major (2 <sup>nd</sup> inv)	Em add11	F# dim (2 inv)	Am
<i>Asturias (Albeniz)</i>	<i>Lagrima (Tarrega)</i>	<i>Vals No. 2 (Lauro)</i>	<i>Spanish Dance No. 5 (Granados)</i>	<i>Vals No. 2 (Lauro)</i>
<i>Play G and E notes as open strings</i>	<i>Play E note as open string</i>	<i>Play all open strings except A note</i>	<i>Play low A note as open string</i>	<i>Play low A note as open string</i>

Image 77

## **Lesson 12 – The extension of the jazz player’s repertoire to classical guitar pieces with a plectrum.**

The quality of sound of any note played is paramount for any serious classical guitarist and, as discovered throughout this thesis, there are a series of very unified and accepted rules that the greatest majority of learners follow in the same way in order to be able to produce that purity and richness of sound which is key to the style.

As explained in previous lessons, those sound qualities require the fingers and fingernails to be used in very specific ways, with meticulous attention to nail length, texture (filed and polished surfaces are needed), angle of approach, point of contact (a combination of skin and nail produces the best basic sound), depending on the passage nails only or skin only will be more appropriate and provide drastically

different tones, etc. Not surprisingly, this is why the production of the same sound (and range of sounds) with a plectrum is very difficult to achieve.

Nonetheless, tonal qualities aside, it is indeed physically possible to play many classical pieces with a plectrum. This offers the jazz player (as well as players in other styles) a valuable window into the world of classical guitar music and the developments it has made within the world of guitar performance.

If selected appropriately, these pieces can provide first-hand insight into aspects of classical practice such as the use resonating arpeggios as a vehicle to harmonic and melodic creation and development, the combination of dialled and open strings to create unique (non-transposable) textures and voicings of chords (such as those explored in lesson 11), the demands for a very advanced left hand technique required to play constantly-changing and demanding shapes as well as movements which require great finger independence, or the demands for the memorisation of great amounts of non-repetitive information of this type during long developments and forms. Apart from that, the general classical approach to composition will be in use, demonstrating approaches to things such as thematic and melodic development, structure, form and harmonic development.

Following are two studies which I have selected as examples of the type of repertoire described above. They evolve in complexity, ranging from beginner to intermediate. I will provide a description of the reasons why they are useful examples prior to presenting each score.

#### *Aguado Study (two parts)*

The Aguado classical guitar studies are some of the most popular and established routes to acquiring the types of techniques which will be required to play a great amount of the classical repertoire. In this particular case, the main element to observe is that of arpeggio-based playing. Of course arpeggios are in use in many different types of guitar performance. As Alan Williams suggests during the interview undertaken for this research, however “There is a kind of division, in popular music and jazz, between the melodic line and the chord”, in other words, players usually do

one or the other at any given time, and arpeggios generally tend to be a melodic element backed up by a chord, or they provide the harmony over which a separate melodic line is played. Classical guitar, on the other hand, is one of the few guitar styles which are mostly played in a solo context, and this demands a presentation of both melody and harmony from one instrument. This is the main reason why, in classical guitar music, the arpeggio often takes the job of presenting harmonies and harmonic development, as well as (through its very nature of plucking strings subsequently from each other) providing a melody. Often, the harmony is emphasized as the player allows notes related to a particular chord to ring out whilst more notes are introduced, until a change to a different harmony is made. This helps to strengthen the sense of all musical elements being presented by one instrument, and is the case of this particular study.

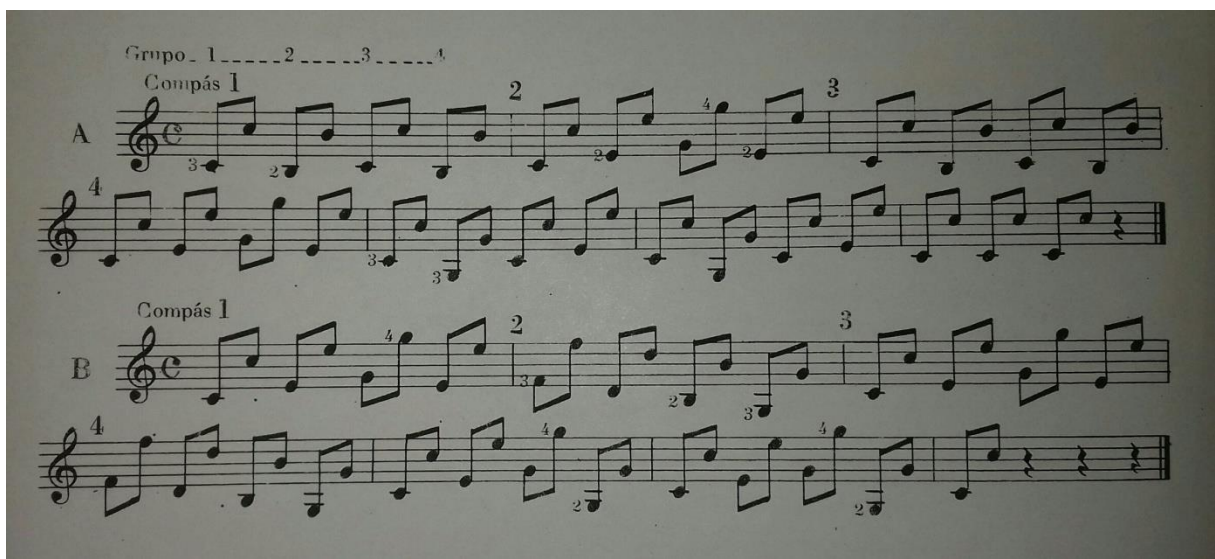

Dionisio Aguado study. Image 78

### Fernando Sor Study in D major

This study presents similar ideas to the one shown previously. However, in this case, the player will be able to see how the types of shapes and chord voicings used evolve as the repertoire becomes more involved. As far as the way the instrument is used compositionally, it is a good exercise for jazz guitarists to analyse the basic harmony of the piece, and relate it to the shapes that are used. They will be able to



find chord voicings which are unique to certain keys on the guitar, and that perhaps they haven't encountered often before, as well as being able to observe how combinations of open and dialled strings are used to create interesting textures and sound colours that wouldn't be possible with conventional shapes.

# ESTUDIO VI

Allegro grazioso

The image displays a page of musical notation for a guitar study. It consists of seven staves of music, each beginning with a treble clef and a key signature of one sharp (F#). The tempo is marked 'Allegro grazioso'. The notation includes various rhythmic values, primarily eighth and sixteenth notes, often beamed together. Fingerings are indicated by numbers 1-4 and 0 (natural). Dynamics such as *p* (piano), *f* (forte), and *mf* (mezzo-forte) are used throughout. The piece is divided into sections, with 'C II' appearing above several staves. There are also circled numbers (1, 2, 3, 4, 5, 6) and other markings like 'espr.' (espressivo) and 'mf' (mezzo-forte) scattered across the score.

Fernando Sor Study N. VI. Image 79

## **Identifying a series of important jazz-derived advances to inform classical playing**

Similarly as indicated at the beginning of the previous chapter on identifying classical-derived advances that can benefit the jazz player, the idea of classical guitarists benefitting from jazz is not a new one. Guitarist Julian Bream is one of the most celebrated classical players of the twentieth century. His first inspiration to pick up the guitar was jazz guitarist Django Reinhardt, and he first learned to play the guitar in that style. After becoming a classical player, he still publicly performed improvised music and allowed the jazz ideology to influence his playing.

“I love playing jazz, because it gives me the freedom to improvise. It has given me a feeling in my classical repertoire of creating the atmosphere of the here and now, just the spark of the moment. That can come from hitting a note with a certain colour that you haven’t hit it with before, or giving another note an extra vibrato, or by accentuation or articulation. If you can keep that ability to be alive to now, then I think that is a precious commodity for an artist” (Bream, 2006).

James Girling and John Harper (both of whom were interviewed in this thesis) are other good examples of professional guitarists who started in jazz and later learned the classical style, being able to use the tools learned from one idiom within the other. After interviewing the great majority of classical guitarists, it was clear that both of these individuals (particularly the vastly more experienced Harper) had a much deeper understanding of the harmonic and compositional aspects of music than their colleagues, which they were able to use to help them navigate the music they play.

However, and again in a similar way as with jazz guitarists, most classical players are unaware of the full extent of the benefits that can be acquired for the performance of music in general (and of course classical), through the understanding of some of the key principles which are essential for jazz playing. In the following lessons I will present and explain these principles, and show ways in which classical players can benefit from them. However, the main purpose of this section is to bring the styles

closer and not to simply (or fully) teach the jazz guitar, so it should not be interpreted as a full method for jazz playing.

## **LESSON 1 – A look into harmonic and compositional understanding as applied to the guitar (the value of understanding the composer’s idiom)**

*If you are a classical player with a thorough understanding of harmony and composition and how it is applied to your instrument, you may wish to skip the first few chapters.*

Through my research into the world of classical and jazz guitar performance, I have learned that this area is generally absent from many (quite probably most) classical teaching environments. As a guitarist who studied classical guitar after studying jazz, my experience of learning classical repertoire was as much one of expanding my understanding of how harmonic and compositional knowledge could be applied to the guitar, as one of learning the mechanics of how to play pieces. This is because, after studying harmony extensively during my jazz learning, I was able to see and hear how specific harmonic and compositional concepts were being used in the pieces as I was learning them.

This experience has enabled me to understand from a compositional perspective the technical aspects of classical music, and in my view permits a greater awareness of the composer’s intention regarding the sensibilities and development of the music, which is an enormous aid to interpretation.

This opinion is shared by the great majority of the players I interviewed as part of my research. They see an awareness of the technical tools used in the composition of the piece as vital in order to interpret the piece as well as possible, and generally see a lack of attention devoted to this area in the teaching of the style. If you would like to benefit from the advantages of understanding these aspects of how music is created, the following few chapters will help. It is impossible to provide a full course on harmony through this guide on stylistic principles. However, I will attempt to provide a

good starting point for the key areas of knowledge required, in a way that sets the student in the right direction for further research and learning.

## LESSON 2 – Chord building

All classical guitarists of an intermediate or higher standard will be of course very familiar with the concepts of scales and chords. However, those looking to gain an understanding of the pieces they play beyond the mechanics of executing the notes, need to look deeply into in the relationship between chord/harmony and scale in their role as some of the core elements of composition.

The vast majority of melodies that appear in music are created according to how they relate to a harmonic structure that is either presented as a block chord or implied with one or more moving lines. Interestingly, these harmonies themselves originate from selections of notes extracted from our twelve note spectrum called scales. These scales are usually presented and practiced in a note by note basis ascending and/or descending. The most important of these is called the major scale, and it is in fact so important that you can analyze (though you don't always have to) basically every melody and chord as directly or indirectly related to a major scale.

*As an example, we will take a common C major scale (two octaves), to be played in seventh position on the guitar and analyze how different chords directly or indirectly relate to it. It is absolutely vital to keep in mind that any given scale (and therefore chords and arpeggios) can be played on the guitar with different shapes/fingerings on the fretboard. For now we will take this very common shape...*



Image 80

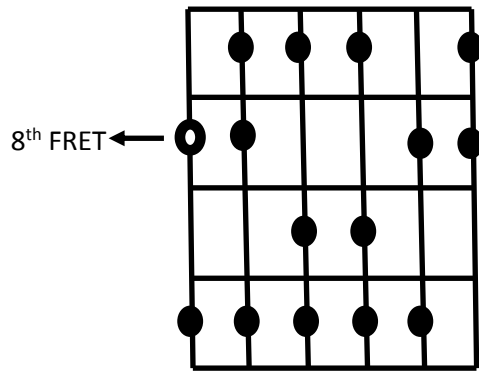

○ =ROOT NOTE

Image 81

Now we will analyze the most closely related chord against it - the C major chord. Major chords are built with the root, third and fifth notes of the scale – as shown by the image below:



C major chord

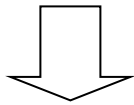

Image 82

Here is one of the most common ways of playing a moveable C major chord on the guitar:

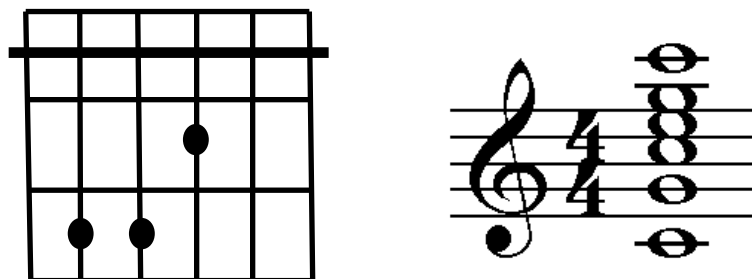

Image 83

The notation may not be instantly recognisable as the C major triad we first saw. A closer look will allow us to see how each of the notes in the chord shape is one of the three notes in the triad shown initially, and is either the root, 3<sup>rd</sup> or 5<sup>th</sup> or the scale. The only reason why the shape has six notes is because some of the notes are repeated (as can be seen below) and played over more than one octave:

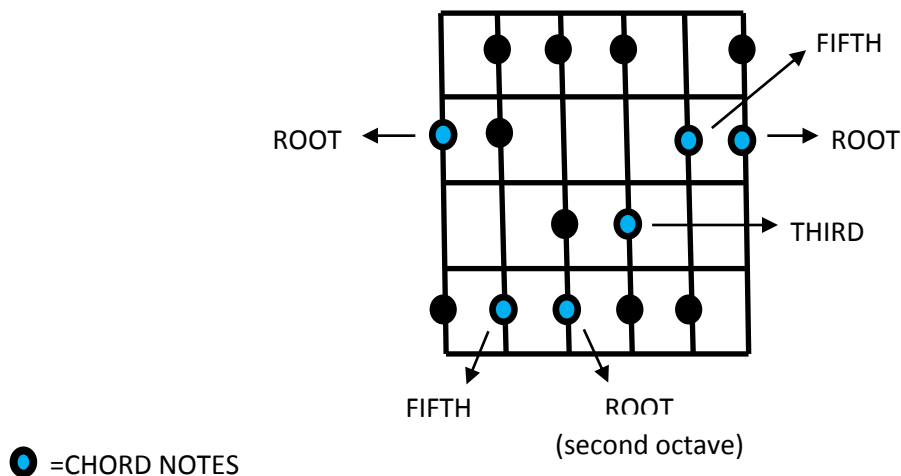

Image 84

As you can see, the notes are not stacked in perfect order (other than starting from the root), and some of the chord degrees are repeated. This makes no difference to

the name of the chord as long as the root is at the bottom. Otherwise we call them: 1<sup>st</sup> inversion if the third of the scale is at the bottom, 2<sup>nd</sup> inversion if the fifth of the scale is at the bottom, and third inversion in the case of the chord having a seventh of the scale at the bottom (which we are not doing for the moment). Also know that if you can find just one of each of the three notes that the chord is built on, you can also have a simple three note shape such as:

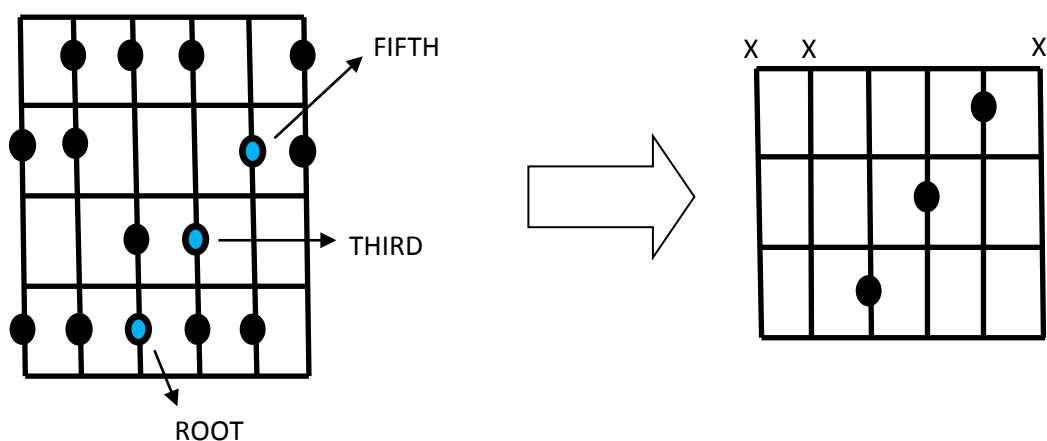

Image 85

We can repeat all of these steps with any kind of chord. The only difference is that, in some cases, some degrees of the scale will need to be moved up or down one semitone, and very occasionally two. This whole process translates in the exact same way to any key and its respective major scale.

As a further example, we will take a Cm7 chord and apply the same analysis. The m7 chord is built with the Root, b3, 5 and b7 degrees of the major scale. So we need to apply the exact same process as before, but lower the 3<sup>rd</sup> and 7<sup>th</sup> notes of the scale one semitone when adding them to the chord (b3rd and b7th). Here is one of the most common ways of playing moveable m7 chords on the guitar:



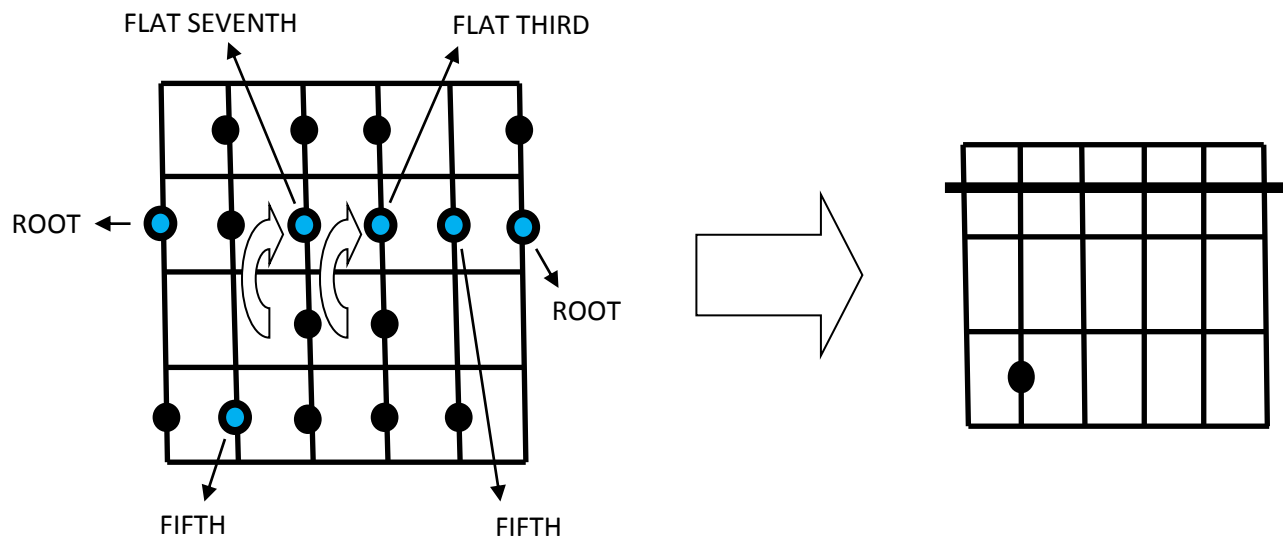

Image 86

As you could see in the previous examples, some chord degrees are at times played in the upper octave. In some cases we assign 'extended' numbers to the same scale degrees, when they appear in the second octave (8<sup>ve</sup>=1<sup>st</sup>, 9<sup>th</sup>=2<sup>nd</sup>, 10<sup>th</sup>=3<sup>rd</sup>, 11<sup>th</sup>=4<sup>th</sup>, 12<sup>th</sup>=5<sup>th</sup>, 13<sup>th</sup>=6<sup>th</sup>, 14<sup>th</sup>=7<sup>th</sup>). At times some of these extended degrees are specifically requested in the chord name (i.e. Em9).

### Lesson 3 – A systematic approach to identifying and learning chord symbols

The system explained above will enable you to navigate your way to finding the notes of any given chord as degrees from the diatonic major scale, once you know what those degrees should be (e.g. C major: Root, 3<sup>rd</sup> and 5<sup>th</sup> degrees from the scale). In order to know what degrees of the scale are needed for any given chord, you need to understand chord symbols. Chord symbols essentially summarise all the information required to identify a specific chord into a short code. The following system will teach you how to interpret any chord symbol.

*For the purpose of showing how they would be used, all chord symbols will be written as if they had to be played from the root note C (as some type of C chord). For study*

*purposes, they will then be followed by their full name in parenthesis, and finally by the degrees of the scale they require. As the reader will be able to see, some chord types can have more than one symbol to identify them.*

*Basic chord symbols (basic triads):*

- *C or Cmaj (C major): Root, 3<sup>rd</sup>, 5<sup>th</sup>*
- *Cm, Cmin, or C- (C minor): Root, b3<sup>rd</sup>, 5<sup>th</sup>*
- *Cdim, or C<sup>o</sup> (C diminished): Root, b3<sup>rd</sup>, b5<sup>th</sup>*

*These are the ones you will need most of the time. However we can add:*

- *Caug (C augmented triad): Root, 3<sup>rd</sup>, #5*

*These triads and their formula (intervals/degrees of the scale) will form the basis of all chords to be learned hereafter.*

*Seventh chords:*

*The degrees which appeared in the previous basic chords (either natural or flattened roots, 3<sup>rds</sup> and 5<sup>ths</sup> from the scale) will now be accompanied by the 7<sup>th</sup> degree.*

*Notice that the basic idea is that notes are selected from the scale in an every-other-one fashion (i.e. Root [no 2<sup>nd</sup>], 3<sup>rd</sup> [no 4<sup>th</sup>], 5<sup>th</sup> [no 6<sup>th</sup>], 7<sup>th</sup>).*

- *Cmaj7, Cmaj7, or C $\Delta$  (C major 7): Root, 3<sup>rd</sup>, 5<sup>th</sup>, 7<sup>th</sup>*
- *Cmin7, or C-7 (C minor 7): Root, b3<sup>rd</sup>, 5<sup>th</sup>, b7<sup>th</sup>*
- *C7 (C dominant 7): Root, 3<sup>rd</sup>, 5<sup>th</sup>, b7<sup>th</sup>*
- *Cm7b5, C-7b5, or C $\emptyset$  (C minor 7 flat 5, or C half diminished): Root, b3<sup>rd</sup>, b5<sup>th</sup>, b7<sup>th</sup>*

*These are the most essential seventh chords, and a whole diatonic major scale can be harmonised with them. Following are other common and useful chords which are based on further combinations of the same four degrees and their variations.*

- *C7#5, or C<sup>aug</sup>7 (C dominant 7 sharp 5, or C augmented 7): Root, 3<sup>rd</sup>, #5, b7<sup>th</sup>.*
- *C7b5 (C dominant seventh flat 5): Root, 3<sup>rd</sup>, b5, b7<sup>th</sup>.*
- *Cmaj7#5, C<sup>Δ</sup> #5, Cmaj7/aug, C<sup>Δ</sup> aug (C major 7 sharp 5, or C major seventh augmented): Root, 3<sup>rd</sup>, #5, 7<sup>th</sup>)*
- *Cmaj7b5, C<sup>Δ</sup> b5 (C major 7 flat 5): Root, 3<sup>rd</sup>, b5, 7. Note: for voicing purposes this chord is most commonly presented as Cmaj7#11, which is actually an almost identical chord but with the b5 in the next octave (#11). More information on voicings later.*
- *C-7#5, Cm7#5 (C minor 7 sharp 5): Root, b3<sup>rd</sup>, #5, b7*
- *Cmin/maj7, C-maj7, or C-<sup>Δ</sup> (C minor major 7): Root, b3<sup>rd</sup>, 5<sup>th</sup>, 7<sup>th</sup>*
- *Cmin/maj7#5; C-maj7#5, or C-<sup>Δ</sup> #5 (C minor major 7 #5): Root, b3<sup>rd</sup>, #5<sup>th</sup>, 7<sup>th</sup>*
- *Cmin/maj7b5, C-maj7b5, or C-<sup>Δ</sup> b5 (C minor major 7 flat 5): Root, b3<sup>rd</sup>, b5, 7<sup>th</sup>*
- *Cdim7, or C<sup>o</sup>7 (C diminished 7): Root, b3<sup>rd</sup>, b5<sup>th</sup>, bb7<sup>th</sup>. Note: the double flat (bb) in this chord does not allow it to fit perfectly into the every-other-note system as applied to the major scale, nonetheless it is still frequently presented as a type of 7 chord (as its symbol suggests) and is a very common chord. However, it can also be (most closely) related to its own “diminished” scale.*

*If you look at the chord types above closely, you will be able to see that all of them, including the least basic ones, are either a type of major (e.g. major 7#5), minor, dominant, diminished, or minor/major (of these, the ones used most frequently are the first four). This is very important, because it reduces our thinking of chords into just five main families.*

*A deeper look into it and we are able to decode what makes each belong to each family: majors always have a 3<sup>rd</sup> and 7<sup>th</sup>; minors always have a b3<sup>rd</sup> and b7<sup>th</sup>; dominants always have a 3<sup>rd</sup> and b7<sup>th</sup>, minor/majors always have a b3<sup>rd</sup> and 7<sup>th</sup>. Through this analysis, it is also important to notice that the 5<sup>th</sup> is not involved in determining what family the chord belongs to. That is, unlike the 3<sup>rd</sup>s and 7<sup>th</sup>s,*

*the type of 5<sup>th</sup> (natural, #5 or b5) will not determine what family a chord belongs to.*

### **Harmonic enhancement and deletion**

*We will now start to enhance the basic chord types shown so far. It is important to be aware that, as chords become enhanced by more notes and tensions, most players start to intentionally leave non-essential notes out of the chords when playing them. Non-essential notes are those which will not determine whether the chord will lose its harmonic function and name/chord symbol. Very often this will be the fifth (unless the chord type indicates a particular type of altered fifth, i.e. 7#5#9). With this system, musicians normally strive for four-note voicings for the majority of chord types. This serves two main purposes:*

- *Practical: The more scale degrees the basic formula of a chord requires, the more complicated it is to play all of them simultaneously on the guitar. This is particularly true with extended chords, where the basic chord formula could have up to seven notes.*
- *Harmonic: The more notes a chord has, and the more tensions within the intervals of the chord, the more dense it can become to listen to, and the harder it can be to aurally perceive its basic function (major, dominant, minor, etc). Therefore, omitting the non-essential degrees is an effective way of retaining the full flavour of the chord, whilst getting rid of the potentially confusing and unpleasantly dense elements. In this way the remaining four notes are comfortably spaced across (usually) two octaves, achieving a more balanced and refined sound.*

*Example:*

*In a dominant chord (7), although the formula includes a 5<sup>th</sup>, the 'dominant' quality is determined by the combination of a 3<sup>rd</sup> with a b7<sup>th</sup>, as explained earlier. Unless the chord symbol mentions a particular type of 5<sup>th</sup> needed (e.g. C7#5), then the 5<sup>th</sup> can be left out from the chord that we play (Root, 3<sup>rd</sup>, [no 5<sup>th</sup>], b7<sup>th</sup>). The same*

*can be done with any of the chords whose qualities are determined by combinations of 3rds and 7ths and which do not demand any specific kind of 5<sup>th</sup> in the chord symbol (maj7, min7, dom7 and min/maj 7).*

### Extended Chords

*As we continue the process of adding notes to our chords in the every-other-one manner used until now, we go beyond the seventh, skip the 8ve, and reach the 9<sup>th</sup>. As mentioned previously, just as the 8ve is the root of the scale reappearing in a higher register, the 9<sup>th</sup> is the second.*

*We will then continue the process: skip the 10<sup>th</sup> (3<sup>rd</sup>) and reach the 11<sup>th</sup> (4<sup>th</sup>), skip the 12<sup>th</sup> (5<sup>th</sup>) and reach the 13<sup>th</sup> (6<sup>th</sup>). If you look closely at the previous statement you will see that the notes we skip, are the ones we already used in the first octave to make the basic triads and seventh chords: 8ve (root), 10ths (3rds), 12ths (5ths) and 14ths (7ths). The new extensions we do add (9ths, 11ths and 13ths) are then the remaining three notes that are left from our seven-note diatonic scale (2nds, 4ths and 6ths), and this means we have now used all degrees of the scale to create chords (Root, 2<sup>nd</sup>, 3<sup>rd</sup>, 4<sup>th</sup>, 5<sup>th</sup>, 6<sup>th</sup>, 7<sup>th</sup>).*

### Further harmonic deletion considerations

*As we start adding extensions, the exact same principles for leaving non-essential chord degrees/notes out as explained previously can be applied to the non essential extended degrees.*

*Example:*

*In a Major 13 chord (maj13), the major quality is determined by the 3<sup>rd</sup> and 7<sup>th</sup>, just as it would in the case of a maj7 chord. The chord symbol does not mention any specific kind of 5<sup>th</sup>. This means that you can leave the 5<sup>th</sup> out. On top of that, the chord symbol requires a 13<sup>th</sup>. This means that you must add that note.*

However, although the basic formula of a maj13th chord includes a 9<sup>th</sup> and an 11<sup>th</sup>, the fact that they are not mentioned in the chord symbol means that I can leave them out as well. In the end I would end up with a four note chord which has all the essential qualities of a maj13 chord, whilst being much more clear and simple (Root, 3<sup>rd</sup>, [no5th], 7<sup>th</sup>, [no 9<sup>th</sup>], [no11th], 13<sup>th</sup>).

Here are the extended chords and their symbols. Remember, the main five families are still in use (major, minor, dominant, diminished, minor/major). Nonetheless here we will mostly use four of them, due to the particularity of the diminished chord explained previously.

- Cmaj9, C $\Delta$  9 (major 9): Root, 3<sup>rd</sup>, 5<sup>th</sup>, 7<sup>th</sup>, 9<sup>th</sup>
- Cmin9, C-9 (minor 9): Root, b3<sup>rd</sup>, 5<sup>th</sup>, b7<sup>th</sup>, 9<sup>th</sup>
- C9 (dominant 9): Root, 3<sup>rd</sup>, 5<sup>th</sup>, b7<sup>th</sup>, 9<sup>th</sup>
- Cm9b5, C-9b5 (C minor 9 flat 5): Root, b3<sup>rd</sup>, b5, b7, 9<sup>th</sup>
- Cmin/maj9, C-maj9, or C- $\Delta$ 9 (minor/major 9): Root, b3<sup>rd</sup>, 5<sup>th</sup>, 7<sup>th</sup>, 9<sup>th</sup>

As with seventh chords, these are the most essential extended chords (the first four being the most common) and they will be repeated with the addition of the 11<sup>th</sup> and 13<sup>th</sup> extensions, as shown below:

- Cmaj11, C $\Delta$  11 (major 11): Root, 3<sup>rd</sup>, 5<sup>th</sup>, 7<sup>th</sup>, 9<sup>th</sup>, 11<sup>th</sup>
- Cmin11, C-11 (minor 11): Root, b3<sup>rd</sup>, 5<sup>th</sup>, b7<sup>th</sup>, 9<sup>th</sup>, 11<sup>th</sup>
- C11 (dominant 11): Root, 3<sup>rd</sup>, 5<sup>th</sup>, b7<sup>th</sup>, 9<sup>th</sup>, 11<sup>th</sup>
- Cm11b5, C-11b5 (C minor 11 flat 5): Root, b3<sup>rd</sup>, b5, b7, 9<sup>th</sup>, 11<sup>th</sup>
- Cmin/maj11, C-maj11, or C- $\Delta$  11 (minor/major 9): Root, b3<sup>rd</sup>, 5<sup>th</sup>, 7<sup>th</sup>, 9<sup>th</sup>, 11<sup>th</sup>
- Cmaj13, C $\Delta$  13 (major 13): Root, 3<sup>rd</sup>, 5<sup>th</sup>, 7<sup>th</sup>, 9<sup>th</sup>, 11<sup>th</sup>, 13<sup>th</sup>
- Cmin13, C-13 (minor 13): Root, b3<sup>rd</sup>, 5<sup>th</sup>, b7<sup>th</sup>, 9<sup>th</sup>, 11<sup>th</sup>, 13<sup>th</sup>
- C13 (dominant 13): Root, 3<sup>rd</sup>, 5<sup>th</sup>, b7<sup>th</sup>, 9<sup>th</sup>, 11<sup>th</sup>, 13<sup>th</sup>
- Cm13b5, C-13b5 (C minor 13 flat 5): Root, b3<sup>rd</sup>, b5, b7, 9<sup>th</sup>, 11<sup>th</sup>, 13<sup>th</sup>

- *Cmin/maj13, C-maj13, or C-Δ 13 (minor/major 13): Root, b3rd, 5<sup>th</sup>, 7<sup>th</sup>, 9<sup>th</sup>, 11<sup>th</sup>, 13<sup>th</sup>.*

*Also as with seventh chords, those degrees that do not take part in defining whether the chord is major, minor, dominant, diminished or minor/major, can be altered (sharpened or flattened) creating many options and colours within the basic chord families as can be seen below.*

*It is important to know that (in order for the root note to avoid being confused for a sharpened or flattened root note, and to make sure that the alteration is applied to the right note within the chord) the chord symbols of extended altered chords always include the basic seventh or extended chord symbol first, and then incorporate the alterations (e.g. D7#9; as opposed to D#9 where the D could be confused for a D# note). The principles of harmonic deletion explained earlier are also needed for all of these chords, as in practice they will mostly be reduced to four and five-note shapes. For this reason the following chords will be shown with those principles already applied to their formulas:*

- *C7#9 (C dominant 7 sharp 9): Root, 3<sup>rd</sup>, 5<sup>th</sup>, b7<sup>th</sup>, #9<sup>th</sup>*
- *C7b9 (C dominant 7 flat 9): Root, 3<sup>rd</sup>, 5<sup>th</sup>, b7<sup>th</sup>, b9<sup>th</sup>*
- *C7#5#9 (C dominant 7 sharp 5 sharp 9): Root, 3<sup>rd</sup>, #5<sup>th</sup>, b7<sup>th</sup>, #9*
- *C7b5b9 (C dominant 7 flat 5 flat 9): Root, 3<sup>rd</sup>, b5<sup>th</sup>, b7<sup>th</sup>, b9<sup>th</sup>*
- *C7#5b9 (C dominant 7 flat 5 sharp 9): Root, 3<sup>rd</sup>, #5<sup>th</sup>, b7<sup>th</sup>, b9<sup>th</sup>*
- *C7b5#9 (C dominant 7 flat 5 sharp 9): Root, 3<sup>rd</sup>, b5<sup>th</sup>, b7<sup>th</sup>, #9<sup>th</sup>*
- *Cmaj7#11, CΔ 7#11 (C major 7 sharp 11): Root, 3<sup>rd</sup>, 7<sup>th</sup>, #11<sup>th</sup>*
- *C7#11 (C dominant 7 sharp 11): Root, 3<sup>rd</sup>, b7<sup>th</sup>, #11<sup>th</sup>*
- *Cm7b13, C-7b13 (C minor 7 flat 13): Root, b3rd, b7<sup>th</sup>, b13<sup>th</sup>*
- *Cmaj9#11, CΔ 9#11 (C major 9 sharp 11): Root, 3<sup>rd</sup>, 7<sup>th</sup>, 9<sup>th</sup>, #11<sup>th</sup>*
- *C13b9 (C dominant 13 flat 9): Root, 3<sup>rd</sup>, b7<sup>th</sup>, b9<sup>th</sup>, 13<sup>th</sup>*
- *C13#9 (C dominant 13 sharp 9): Root, 3<sup>rd</sup>, b7<sup>th</sup>, #9<sup>th</sup>, 13<sup>th</sup>*

- C7b9b13 (C dominant 7 flat 13): Root, 3<sup>rd</sup>, b7<sup>th</sup>, b9<sup>th</sup>, b13<sup>th</sup>

As you can see, the fact that there are so many intervals/scales degrees involved, each with the possibility of being raised or lowered by a semitone, creates several opportunities for variations and sound possibilities. The ones above are most of the ones you will be required to use, however it is of course possible to create more.

### Sus Chords

The main characteristic of suspended chords (or 'sus' chords) is the fact that they do not contain a 3<sup>rd</sup>. This is instead replaced by either the note a semitone above a (major) 3<sup>rd</sup>= a 4<sup>th</sup>, or a semitone below the (minor) b3<sup>rd</sup>=a 2<sup>nd</sup>. And so we add this concept to basic triads first:

- Csus4 (C suspended 4): Root, 4<sup>th</sup>, 5<sup>th</sup>
- Csus2 (C suspended 2): Root, 2<sup>nd</sup>, 5<sup>th</sup>

We can also do the same with the upper octave version of the suspended notes:

- Csus11 (C suspended 11): Root, 5<sup>th</sup>, 11<sup>th</sup>
- Csus9 (C suspended 9): Root, 5<sup>th</sup>, 9<sup>th</sup>

The diminished and augmented versions of sus chords (with a flattened or augmented fifth) are uncommon, but nonetheless possible, e.g.:

- Cdim/sus2 (C diminished suspended 2): Root, 2<sup>nd</sup>, b5

We can also apply the concept to seventh or extended chords, simply replacing the thirds of the given chord for the suspended note indicated, for example:

- C7sus4 (C dominant 7 suspended 4): Root, 4<sup>th</sup>, 5<sup>th</sup>, b7<sup>th</sup>
- C13sus2 (C dominant 13 suspended 2): Root, 2<sup>nd</sup>, b7<sup>th</sup>, 13<sup>th</sup> (5<sup>th</sup> optional, as harmonic deletion can be applied).

### Add chords



The main characteristic of the add (added) chord is that it takes a basic triad (three-note chord, with no seventh) and adds a note to it which it indicates in the chord symbol, without having to incorporate any notes that may be in-between. For example:

- Cadd9 (C major with added 9): Root, 3<sup>rd</sup>, 5<sup>th</sup>, 9<sup>th</sup> (no 7<sup>th</sup>)
- C add11 (C major with added 11): Root 3<sup>rd</sup>, 5<sup>th</sup>, 11<sup>th</sup> (no 7<sup>th</sup>)

The most common add chord is by far the add9, but following the logic explained, many can be created.

### Six chords

Six chords are essentially basic triads which are accompanied by a major sixth interval:

- C6, Cmaj6 (C major 6): Root, 3<sup>rd</sup>, 5<sup>th</sup>, 6<sup>th</sup>
- Cmin6, C-6 (C minor 6): Root, b3<sup>rd</sup>, 5<sup>th</sup>, 6<sup>th</sup>

All rules explained previously can be applied to the chords to create colours. Many are uncommon; however some are indeed useful and appear frequently, for example:

- C6add9, C69, or Cmaj69 (C major 6 with an added 9): Root, 3<sup>rd</sup>, 6<sup>th</sup>, 9<sup>th</sup> (5<sup>th</sup> can be omitted for harmonic deletion purposes).
- C-6add9, C-69, or Cmin69 (C minor 6 with an added 9): Root, b3<sup>rd</sup>, 6<sup>th</sup>, 9<sup>th</sup>.

### Slash chords and inversions

You will frequently come across chords which have a slash (/) to their right hand side, and a note written on the other side (e.g.C/G). This simply means that the chord is played as normal but the note on the right hand side of the slash must be added as a bass note (the lowest note in the chord). For example:

- D/A (a D major chord with an A bass note). From low to high it could have any order of its necessary intervals, as long as the A note is on the bass (e.g. A – D – A – D – F#)

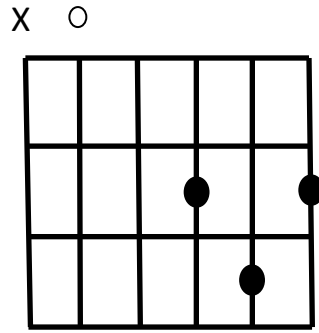

Image 87

### LESSON 4- The importance of repositioning

As previously mentioned, the same chords, arpeggios and scales on the guitar can be played with different fingerings and shapes. In order to master the fretboard we need to become fluent at applying the concepts introduced in Lesson 2 and be able to translate them to any shape of the major scale, and later other scales. Here are some useful examples you can start with.

*This is a C major scale played from the 6<sup>th</sup> string with a different shape to the one used before, demonstrating how a major chord (with the exact same formula as before- Root, 3<sup>rd</sup> and 5<sup>th</sup>) can be extracted from it:*

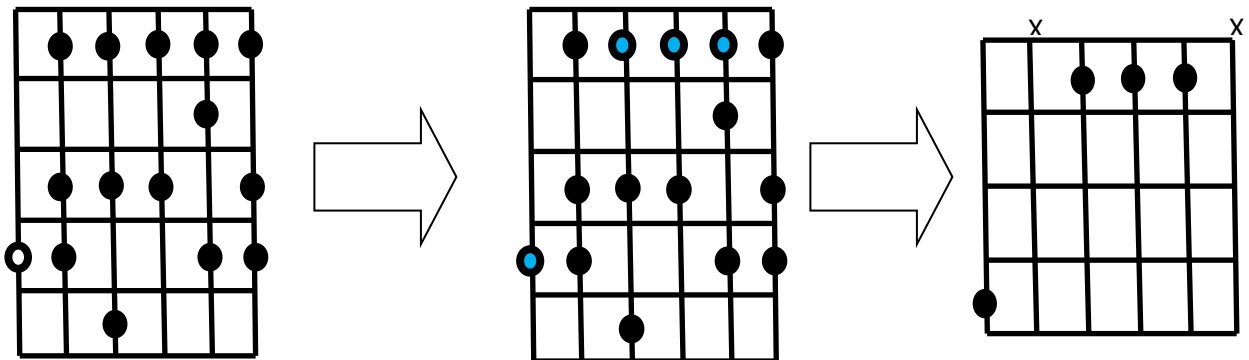

Image 88

You can now start trying different voicings (note organizations) of the same chord formula. You may also try inversions (1<sup>st</sup> inversion with the third at the bottom, 2<sup>nd</sup> inversion with the fifth at the bottom, third inversion with the seventh at the bottom- if the chord has a seventh) For example, a first inversion, with the third at the bottom:

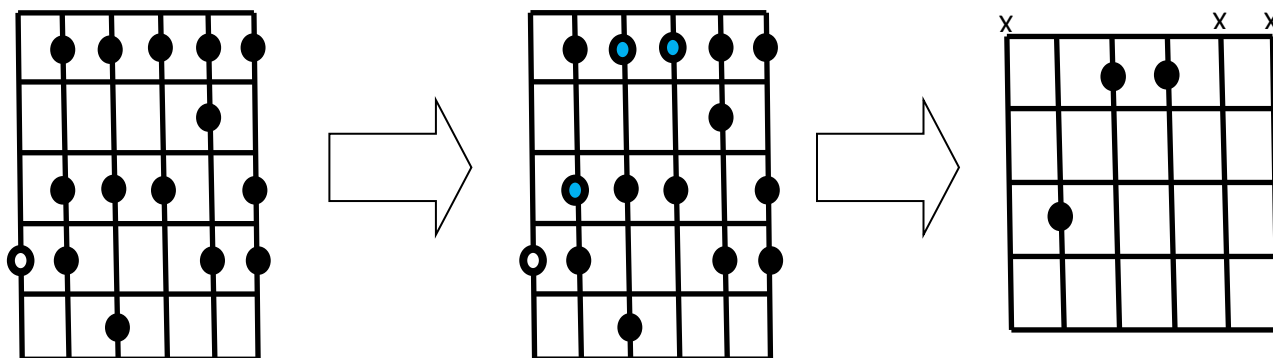
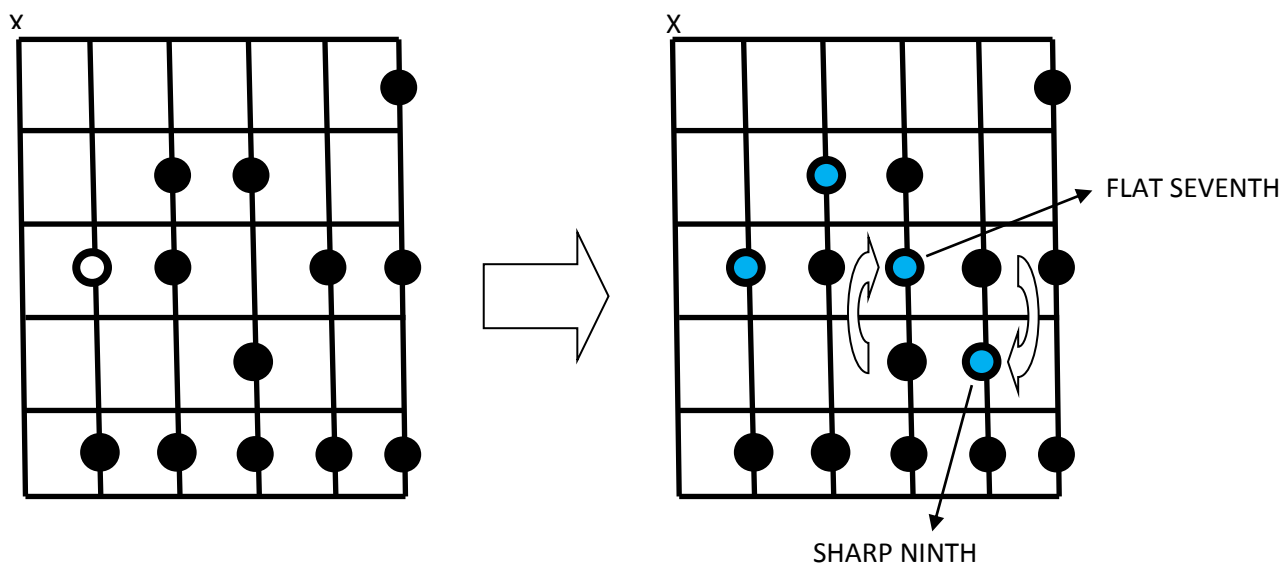

Image 89

Try this other major scale with its root on the fifth string. Play it in the key of D and analyze the D7#9 chord derived from it (the D7#9 chord consists of the Root, 3<sup>rd</sup>, 5<sup>th</sup> [which will be omitted for harmonic deletion purposes], b7<sup>th</sup> and #9<sup>th</sup> [#2<sup>nd</sup> of the second octave] of the major scale):



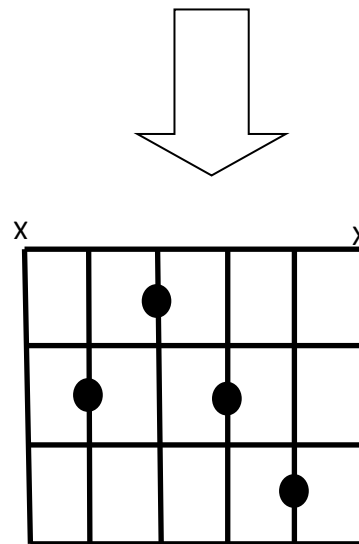

Image 90

All of the scale shapes shown up to now are moveable shapes. They can be played from any fret/in any key, and the same chord types (and many others) can be derived from it in each key. Remember to take into account that you may need to swap a fretted note for an open string if you are to play them in some of the lowest positions on the neck. Following is an example.

*This previously learned C major scale shape with the root on the sixth string...*

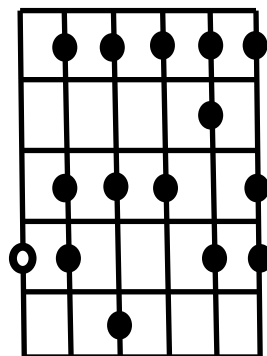

Image 91

Taken to the key of G (from the third fret) would be:

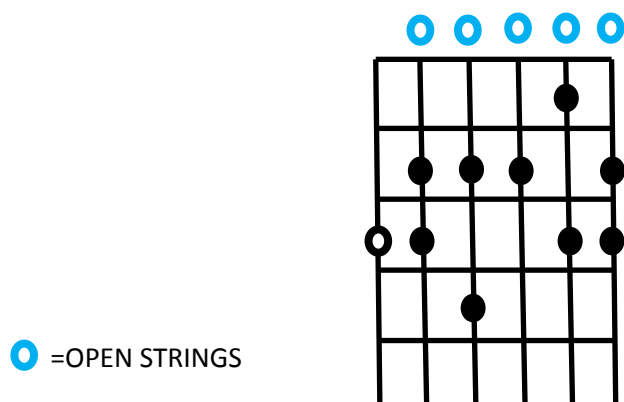

Image 92

Here are some other important shapes for the major scale (in no particular key, just as moveable shapes useable in any key):

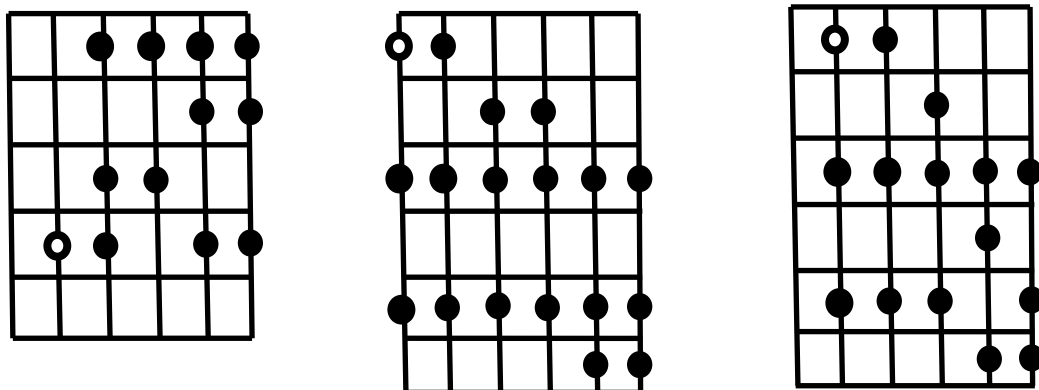

Image 93

Using the tools provided in this and the first two lessons, try finding the chords in the following list using any of these new major scale shapes in any key. Remember that as chords become extended or more dissonant you should use the technique for Harmonic Deletion described in lesson 2 in order to reduce the amount of notes you have to find/play, and to get a more balanced/clear sound. This technique also lets you be the judge as to when you prefer to keep/delete the non-essential notes, allowing your own personality to influence the sound.

- *Maj 7: root, 3<sup>rd</sup>, 5<sup>th</sup>, 7<sup>th</sup>*
- *7: root, 3<sup>rd</sup>, 5<sup>th</sup>, b7<sup>th</sup>*
- *min7: root, b3<sup>rd</sup>, 5<sup>th</sup>, b7<sup>th</sup>*
- *m7b5: root, b3<sup>rd</sup>, b5<sup>th</sup>, b7<sup>th</sup>*
- *Dim: root, b3<sup>rd</sup>, b5<sup>th</sup>, bb7<sup>th</sup>*
- *Maj9: root, 3<sup>rd</sup>, 5<sup>th</sup>, 7<sup>th</sup>, 9<sup>th</sup> (take out 5<sup>th</sup>)*
- *9: root, 3<sup>rd</sup>, 5<sup>th</sup>, b7<sup>th</sup>, 9<sup>th</sup> (take out 5<sup>th</sup>)*
- *min9: root, b3<sup>rd</sup>, 5<sup>th</sup>, b7<sup>th</sup>, 9<sup>th</sup> (take out 5<sup>th</sup>)*
- *m11: root, b3<sup>rd</sup>, 5<sup>th</sup>, b7<sup>th</sup>, 9<sup>th</sup>, 11<sup>th</sup> (take out 5<sup>th</sup> and 9<sup>th</sup>)*
- *Maj 13: root, 3<sup>rd</sup>, 5<sup>th</sup>, 7<sup>th</sup>, 9<sup>th</sup>, 11<sup>th</sup>, 13<sup>th</sup> (take out 5<sup>th</sup>, 9<sup>th</sup> and 11<sup>th</sup>)*
- *13: root, 3<sup>rd</sup>, 5<sup>th</sup>, b7<sup>th</sup>, 9<sup>th</sup>, 11<sup>th</sup>, 13<sup>th</sup> (take out the 5<sup>th</sup>, 9<sup>th</sup> and 11<sup>th</sup>)*
- *m13: root, b3<sup>rd</sup>, 5<sup>th</sup>, b7<sup>th</sup>, 9<sup>th</sup>, 11<sup>th</sup>, 13<sup>th</sup> (take out the 5<sup>th</sup>, 9<sup>th</sup> and 11<sup>th</sup>)*
- *7#5: root, 3<sup>rd</sup>, #5, b7*
- *7b5: root, 3<sup>rd</sup>, b5, b7*
- *7#9: root, 3<sup>rd</sup>, 5<sup>th</sup>, b7, #9 (take out the 5<sup>th</sup>)*
- *7b9: root, 3<sup>rd</sup>, 5<sup>th</sup>, b7, b9 (take out the 5<sup>th</sup>)*

## **LESSON 5 – Unveiling the fretboard**

As said before, most notes on the guitar appear in multiple places. This can make the instrument difficult to master, as we have to learn several different shapes for each chord, scale or arpeggio. In order to be free and have access to all the harmonic and melodic possibilities on the instrument, we need to be able to see the notes to any given scale as they appear (and reappear) over the whole fretboard. As an example, here is a G major scale as it would appear on the entire neck up to the 12<sup>th</sup> fret. (As you may be able to see, the notes of the open strings reappear in the same order on the 12<sup>th</sup> fret, which means that the whole pattern repeats itself again on the remaining higher frets).

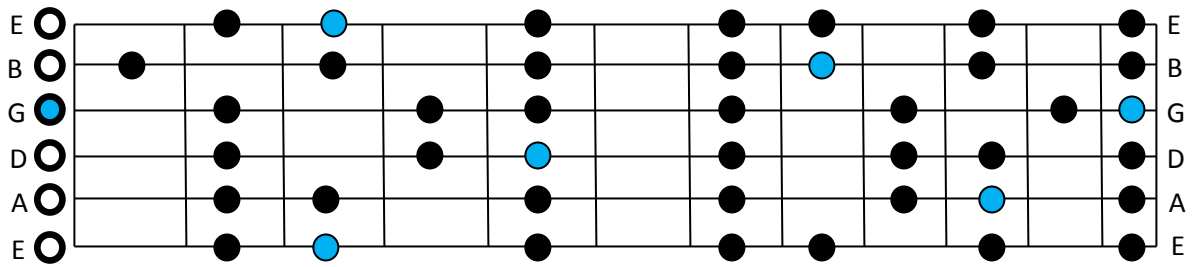

Image 94

*From this knowledge of where the notes of the scale appear on the whole instrument, you can discover the many different ways that the same scale can be played. All of the major scale shapes we learned previously are indeed also here. For example:*

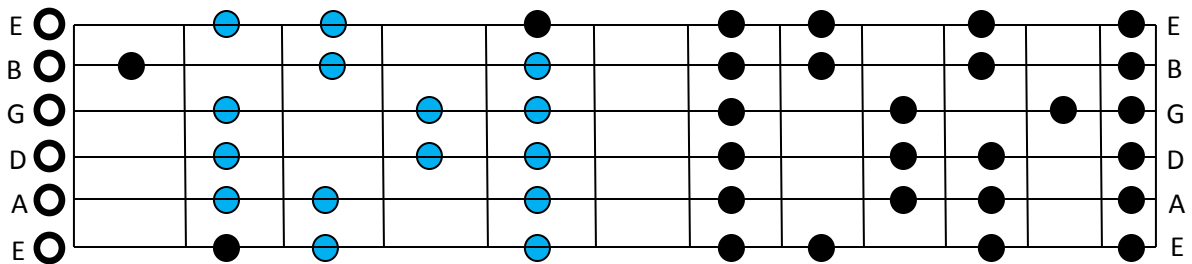

Image 95

*And...*

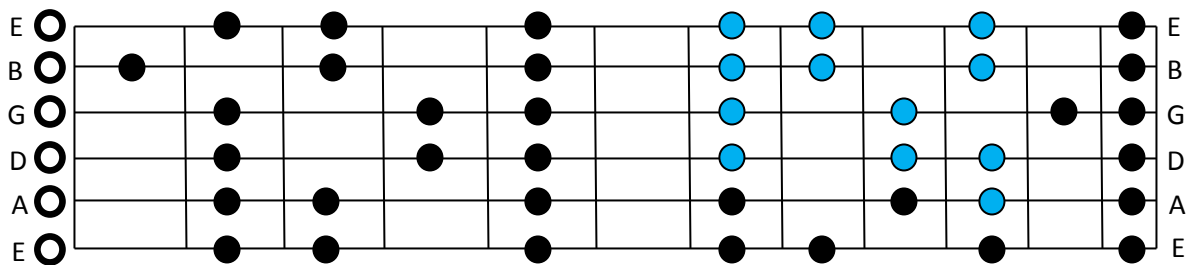

Image 96

*And others...*

*However, apart from selecting positional shapes, you can now develop and use this knowledge to play, write, or improvise in key, in the same scale, in any area of the neck. Most importantly, as these shapes are all moveable, you can apply exactly the same diagram to any key. You just have to make sure that you align it so that the tonic/root is that of your new key. The concept of Mental Imaging and the CAGED system can be of great help to achieve this essential aspect of the mastery of the instrument. It will be discussed later in Lesson 10.*

## **LESSON 6 – Introduction to modes**

The concept of modes is simple, but because the notes on the guitar tend to reappear in different places, they can at times seem complicated to understand and master on our instrument. Modes result when we play a scale starting from a note other than its root note, and follow the scale up until we reach the same note again in the next octave. If the scale has seven notes there will be seven modes (seven notes you could play the scale from, including the original). The most important scale of all is of course the major scale, and the most important modes to learn are the modes of that scale. However, the concept can be (and should eventually be) applied to any other scale (most importantly the Harmonic Minor Scale and the Melodic Minor Scale). Each new mode will be directly related, and in the same key, as the original major scale to which they belong. However they each will also offer a particular sound when played individually.

Here again is the fretboard-long diagram from the previous lesson on **Unveiling the Fretboard**, in the key of G major/G major scale. Notice that if you play this diagram by simply playing all the notes on the sixth string, you also get the G major scale.



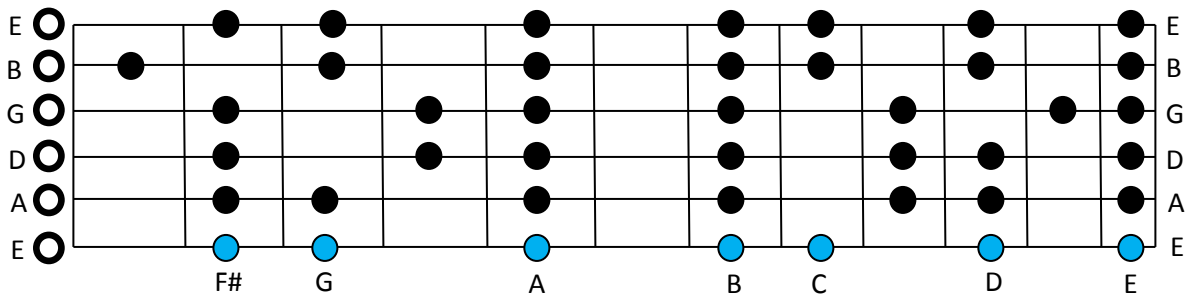

Image 97

This facilitates the understanding of the modes because as we try to play the same major scale but starting and finishing on notes other than the root, we can use each of these notes on the sixth string as our starting point for each individual mode. In this way we can make sure that we find a six-string shape for every mode – something we couldn't do if we started each mode from the notes of an in-position major scale.

We will now start unveiling all the modes, in order, in the key of G. All of the names and shapes will repeat in the same way in any key. As before, you just need to align everything accordingly so that the overall tonic is that of your desired key.

- 1- The first mode starts from the first note, and is the major scale itself, which in its 'modal' name is called **Ionian**.

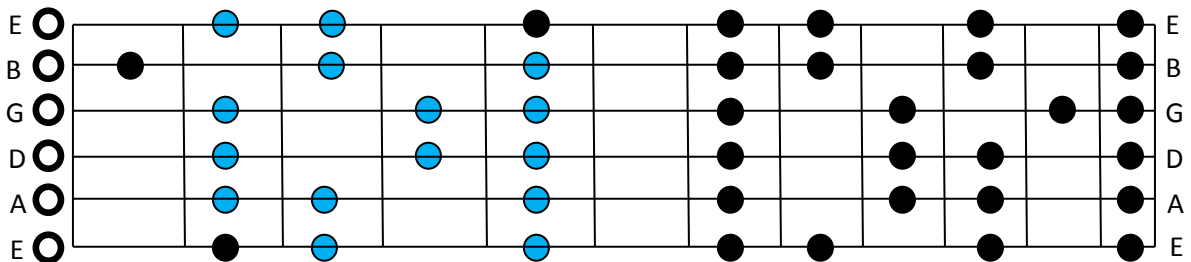

Image 98

2- The second starts from the second note and is called **Dorian**.

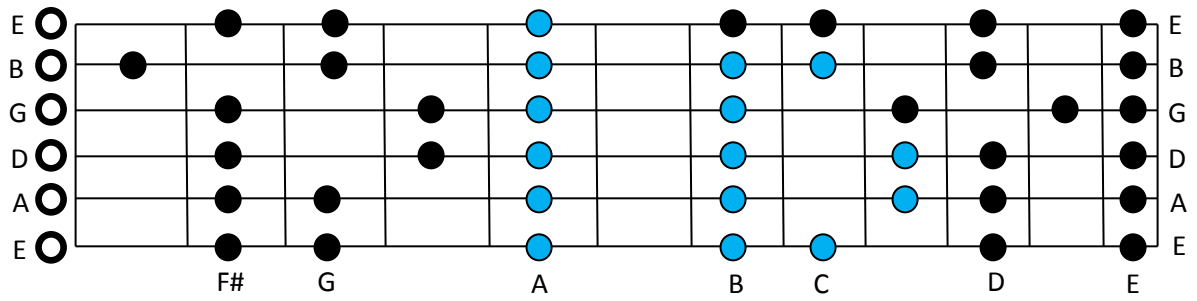

Image 99

3- The third starts from the third note and is called **Phrygian**

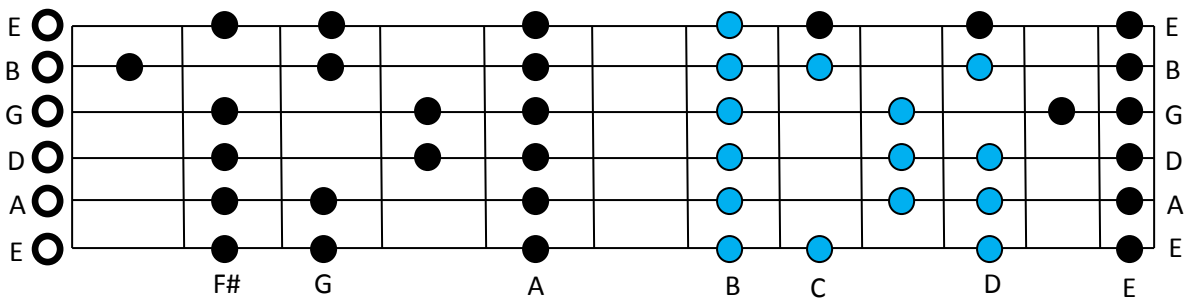

Image 100

4- The fourth starts from the fourth note and is called **Lydian**

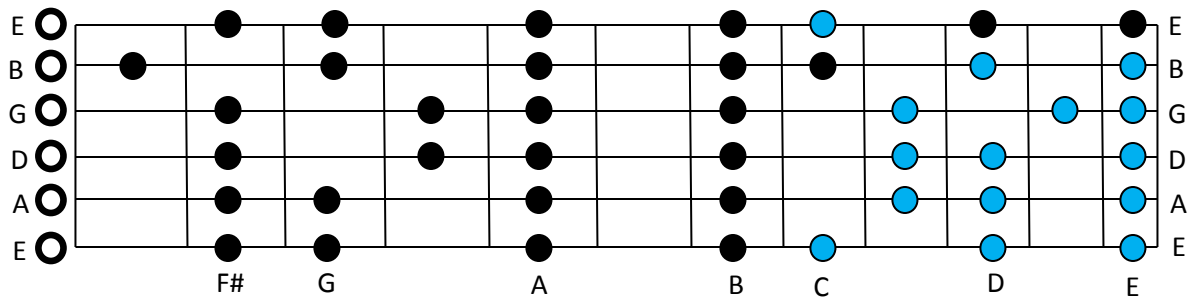

Image 101

5- The fifth starts from the fifth note and is called **Mixolydian**

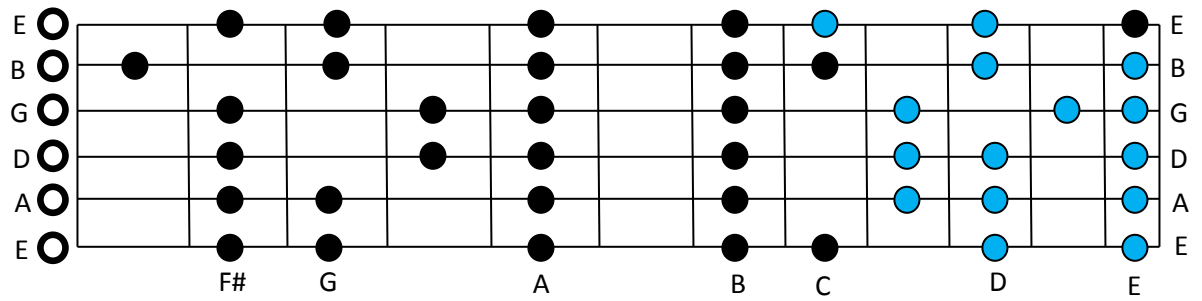

Image 102

6- The sixth starts from the sixth note and is called **Aeolian**

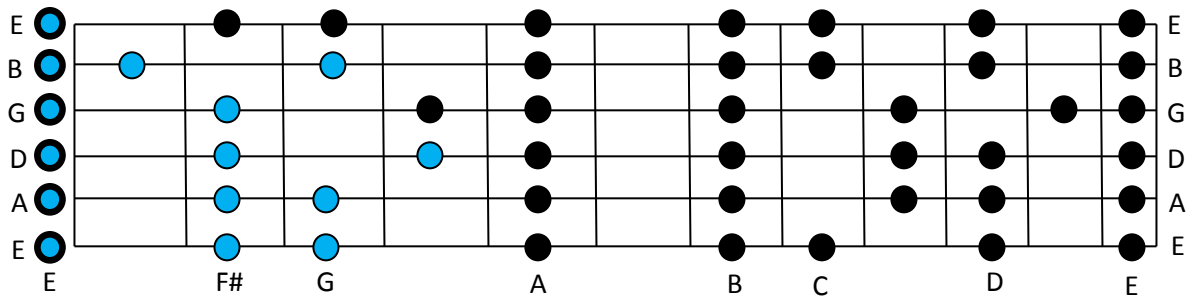

Image 103

7- The seventh starts from the seventh note and is called **Locrian**

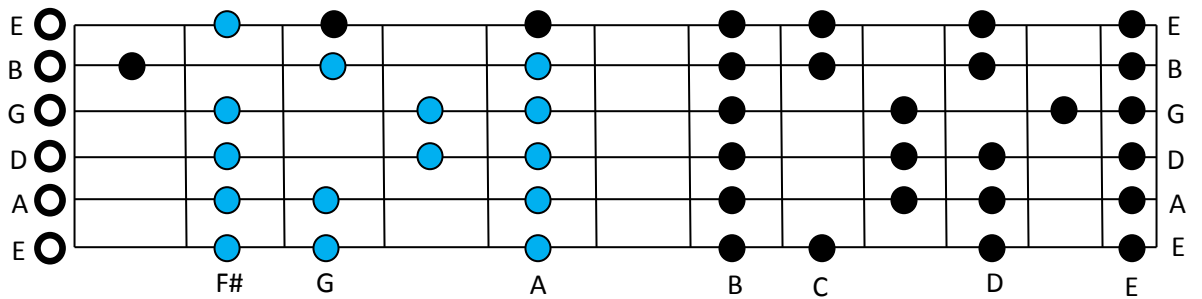

Image 104

Notice that, just like any other chords and scales, the repetitive nature of the guitar – based on the same notes reappearing on different strings- means that any mode can be played with different shapes. As long as we start on a given note from the major scale and go through all remaining notes of that scale until reaching the one we started from, the mode will be revealed. For example, here is an alternative pattern for the Lydian scale/mode to the one presented earlier (notice its similarity to the Dorian scale shape introduced previously – indeed it is the same shape but starting on its third note [4<sup>th</sup> note of the overall tonic – G]).

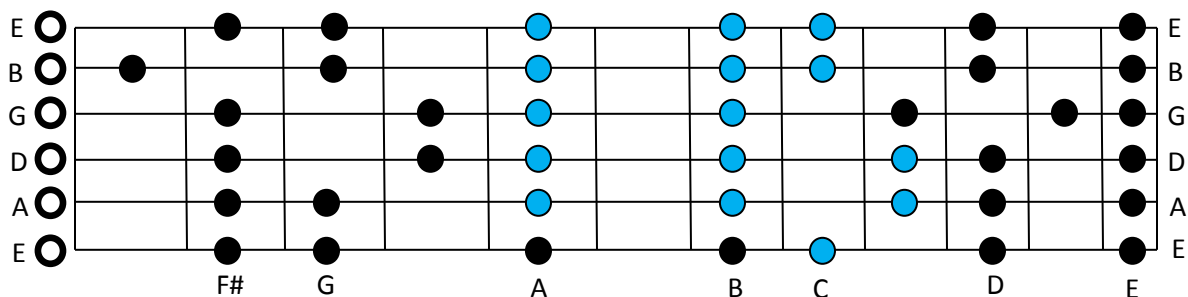

Image 105

## **LESSON 7 – The importance of learning scales not only as finger patterns but as unique presentations of intervals, as derived from the major scale.**

As you hopefully were able to see in the previous chapter, each mode is directly related to its parent major scale, and includes the same notes. The only difference is its starting degree. Nonetheless, when played by themselves (particularly when doing so without previously playing the corresponding home/major scale) each of these modes will also produce a unique sound. This is because, when starting on a degree other than the first, the sequence of intervals that will be produced will be different.

*This can be visually explained in the following way, with (s) meaning semitone and (t) meaning tone. Observe the difference in the pattern of tones and semitones between the Major scale (Ionian mode) and the Dorian mode:*

Major Scale (Ionian mode)

**I (t) ii (t) iii (s) IV (t) V (t) vi (t) vii (s) I**

Dorian Mode (major scale starting from the second degree and continuing until reaching the same degree again on the next octave)

**ii (t) iii (s) IV (t) V (t) vi (t) vii (s) I (t) ii**

As can be seen, the pattern of tones and semitones is different. The same will also happen with each mode. This is the reason why there is a different and unique sound to each mode, and indeed to any other scale.

*Examine the modes you have learned and pay attention to the patterns of tones and semitones, you will see how they are each different and unique. Learning them and memorizing them will mean that you can internalise the shapes better, and find different positions and fingerings to play them much easier. It will also mean that you will be able to understand the scale/mode outside of the guitar and, as long as you understand how to play semitones and tones, will be able to find the scale in any other instrument.*

Following are the patterns of tones and semitones for all the major scale modes, as well as for other scales which will be important to become familiarised with outside of the major scale and its modes.

### ***The major scale and its modes***

Major scale (Ionian mode): **I (t) ii (t) iii (s) IV (t) V (t) vi (t) vii (s) I**

Dorian: **ii (t) iii (s) IV (t) V (t) vi (t) vii (s) I (t) ii**

Phrygian: **iii (s) IV (t) V (t) vi (t) vii (s) I (t) ii (t) iii**

Lydian: **IV (t) V (t) vi (t) vii (s) I (t) ii (t) iii (s) IV**

Mixolydian: **V (t) vi (t) vii (s) I (t) ii (t) iii (s) IV (t) V**

Aeolian: **vi (t) vii (s) I (t) ii (t) iii (s) IV (t) V (t) vi**

Locrian: **vii** (s) **I** (t) **ii** (t) **iii** (s) **IV** (t) **V** (t) **vi** (t) **vii**

### ***The harmonic minor scale***

The harmonic minor scale can be constructed by raising the seventh degree of the Aeolian (or Natural Minor) scale. The resulting pattern of tones and semitones is as follows (TS refers to one tone and a half):

T – S – T – T – S – TS – S

### ***The melodic minor scale***

The melodic minor scale can be constructed by raising the sixth and seventh degrees of the Aeolian (or Natural Minor) scale. It can also be constructed by taking a Harmonic Minor scale and raising the sixth degree. Another way in which it can also be obtained is by taking a root note (starting note) and building a major scale from it with a flattened third. All of these methods will achieve the same scale, and therefore the same pattern of tones and semitones, which is as follows:

T – S – T – T – T – T – S

It is important to know that this same scale has two very popular applications. In classical music it is often used to develop musical ideas in composition. In order to play the scale in the way that most classical composers think of it and utilise it we must play it in its original form ascending, and switch to the Aeolian (Natural Minor) scale descending. In jazz music this scale is seen as any other scale in the sense that it is played in its original form both ascending and descending. Used in this way, this scale is a very important element of both improvisation and composition in jazz.

As with the major scale itself, these other scales also have their own modes which can be revealed by using the exact same principle: by playing them starting from a degree other than the first, and following the scale up until reaching that same degree again in the next octave.

Many are very popular amongst composers and improvisers. For example, the fifth mode of the harmonic minor scale (a Phrygian scale with a raised third –sometimes called Phrygian Dominant) is frequently used to get a Spanish or Arab/North African sound by composers of different genres. Similarly, the seventh mode of the Melodic Minor scale (a Locrian scale with a flattened fourth – often called Superlocrian, Altered or Diminished-Whole tone scale) is very frequently used in jazz and contemporary music to improvise and create melodies over altered dominant chords.

***Learning the intervals to any scale as related to the major scale***

Just as we learned during earlier chapters to use the major scale as an easy route to working out the intervals/notes to any chord, we can also use it as our guiding reference when looking for the intervals/notes to any scale. For example, a Harmonic Minor scale can be defined as a major scale with a flattened third and sixth, as shown below:

The Major Scale

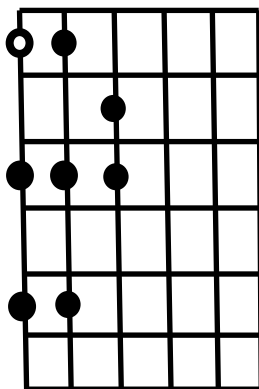

The Harmonic Minor scale

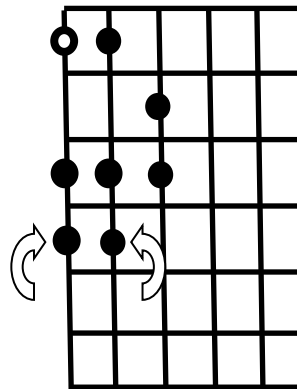
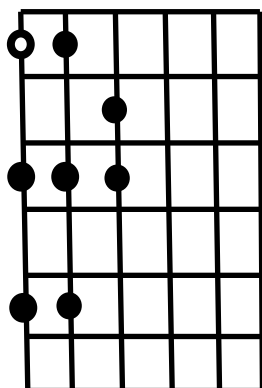

Image 106

Similarly, in a non-diatonic way (not in the same key/not belonging to the same parent major scale) a Mixolydian scale can be defined as a major scale with a flattened seventh:

The Major Scale



The Mixolydian Scale

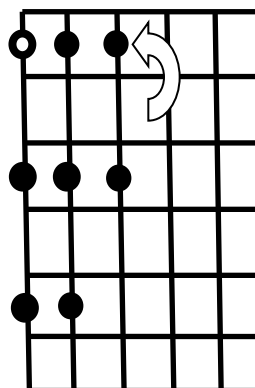
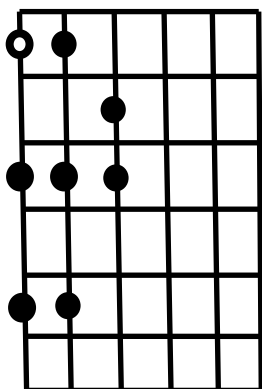

Image 107

As a further example (and as mentioned earlier), a Melodic Minor scale can be defined as a Major Scale with a flattened third:

The Major Scale



The Melodic Minor Scale

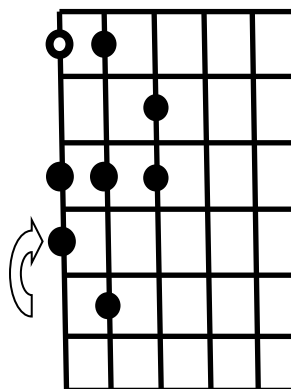

Image 108



## LESSON 8 –Diatonic chords, common chords progressions and secondary dominant chords

Just as there are different scales (modes) that we can derive from playing the major scale starting on notes other than its tonic, there are also different chords that can be derived from each note/degree of the scale. They are frequently known as diatonic chords. As with many others, we build diatonic chords by selecting their root note, then adding the note a diatonic third away from it (two scale notes away), and then repeating that process one more time from that note (for triads), and another time (for seventh chords). You can also continue that process into the next octave, in order to obtain chords with **extensions** such as 9ths, 11ths and 13ths.

The chords that we will derive from each scale degree will also correspond to (and will be compatible with) the modal scale derived from that same degree. For example, the chord derived from the second note of the major scale, will be compatible with the second mode derived from the major scale –Dorian. Here are the seventh chords that appear when we apply this process to each degree of the major scale in C.

*C major scale:*



Image 109

*Diatonic 7<sup>th</sup> chords:*

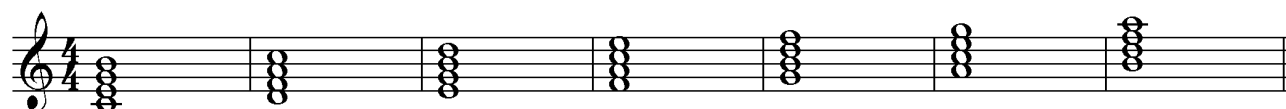

C maj7

D min7

E min7

F maj7

G7

A min7

B min7b5

I

ii

iii

IV

V

vi

vii

Image 110

These chord types and their order will repeat in exactly the same way in every key, simply with their respective root notes corresponding to the specific notes found in the major scale in the desired key. In order to play them on the guitar, close position voicings (such as the ones above – with all the notes as close together as possible) can at times be difficult to play for the left hand. Below are alternative ways of playing these chords that are very common amongst guitarists, being easier to play and also providing good spacing/voicing between the notes.

**Roots on the 6<sup>th</sup> string:**

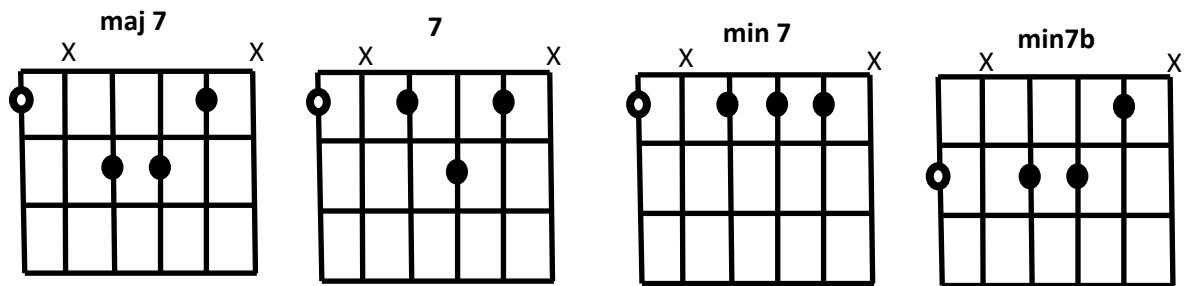

Image 111

**Roots on the 5<sup>th</sup> string:**

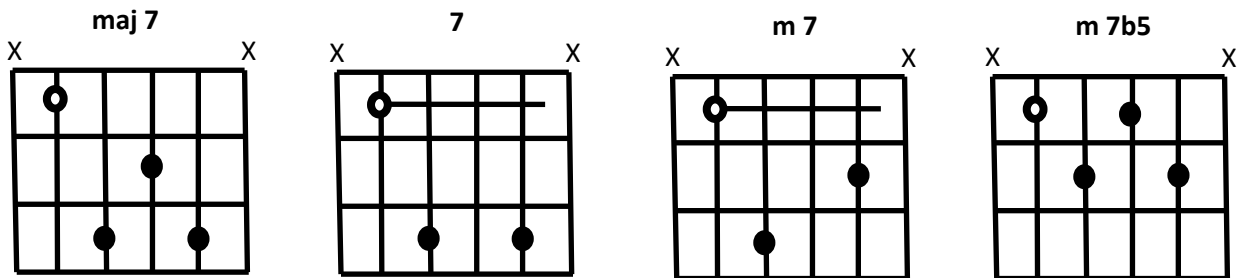

Image 112

**Roots on the 4<sup>th</sup> string:**

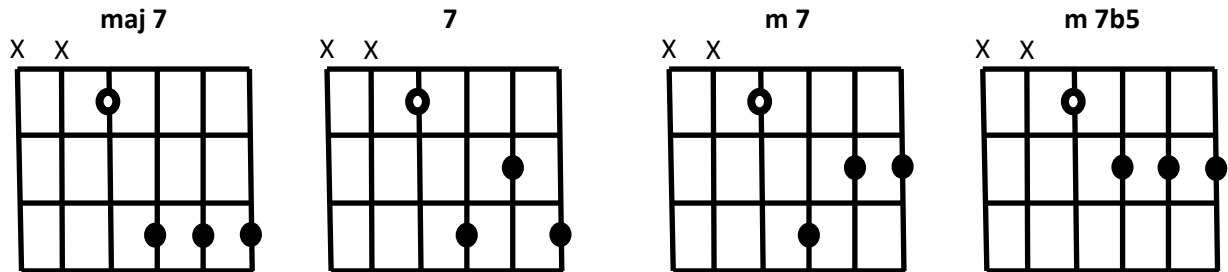

Image 113

As you may have noticed, each degree/chord of the scale has been assigned a roman numeral, with minors written in lower case roman numerals. This is a standard way of referring to and analyzing the degrees of the key and harmonic progressions. For example, a ii- V – I chord progression in the key of G would be:

ii    V    I

Am7 – D7 – Gmaj7

The ii – V – I is one of the most common chord progressions in jazz and other related styles of music. Several jazz standard pieces (probably most) incorporate all or often segments of this chord progression, such as a ii – V, or a V – I, within larger harmonic sequences.

Here are other common chord sequences in jazz. Try finding the following progressions also in the key of G:

1) I – vi – ii – V – I

2) I – IV – V

3) I – vi – IV – V

### **Secondary Dominants**

Given that many of the chords in these sequences are a perfect fifth away from each other (for example vi and ii, or ii and V) it is possible to create perfect cadences leading to these *non-key tonic* chords by replacing/substituting the first of the two chords shown in either example (a fifth above or fourth below) with a dominant seventh chord, most often referred to as a *secondary dominant* chord substitution. By doing so, for example, a ii – V chord sequence in G major (Am7 – D7) would become A7 – D7; or a vi – ii in the same key (Em7 – Am7) would become E7 – Am7.

In a chord progression such as the I – vi – ii – V – I shown previously, the fact that there are several chords that are a fifth away from each other provides the opportunity to create a chain of secondary dominants, all resolving a fifth away from each other with dominant chords as shown below in the key of G:

I      vi      ii      V      I

Gmaj7 – Em7 – Am7 – D7 – Gmaj7

Gmaj7 – E7 – A7 – D7 – Gmaj7

This, applied to a chain (as above) or to a single chord change, is a very common feature within jazz harmony and repertoire. In each case it is satisfactory due to the major third of each dominant chord resolving up a semitone to the root of the following chord, a sound we are all familiar with in all western music due to the extensive use of perfect cadence.

## **Lesson 9 – Visualisation of rootnotes and intervals for harmonic patterns and the importance on taking material around the cycle of fifths**

There are a series of harmonic patterns (or chords progressions) which are essential for the analysis of western music and jazz, since they reappear very frequently within countless compositions. This means that once the player is able to identify them quickly on any new piece, their playing, interpreting and improvising will benefit greatly. As with the rest of these lessons, this chapter will open up the subject for the student and identify the most important aspects, as well as providing ideas for taking the study further, whilst not covering everything that is possible in this area of knowledge.

In the whole of the western music world, the *perfect cadence* progression, or V – I, is the most common chord transition, taking the harmony from the dominant (V) to the tonic (I). This chord progression is very satisfying and is frequently used to provide a pleasing ending to phrases, sections and pieces, as well as being often used in its reverse (I-V) for the purpose of developing the music away from its tonic. For practical purposes, we will look at the most common way of playing the V-I progression on the guitar, and then we will look into how we can use the cycle of fifths to take this and other progressions throughout the fretboard to all keys.

These are the most common (though not the only) ways to think of and apply the movement of a V moving to the I on the guitar fretboard. In this diagram we will present only the chord root-note from which the appropriate chord type should be applied, utilising the indications explained earlier in the lesson (i.e. ii=m7, V=7, I=maj7):

Whenever we have a V on the 6th String (anywhere on the fretboard and regardless of the key) the I will be exactly below it on the same fret on the 5th string:

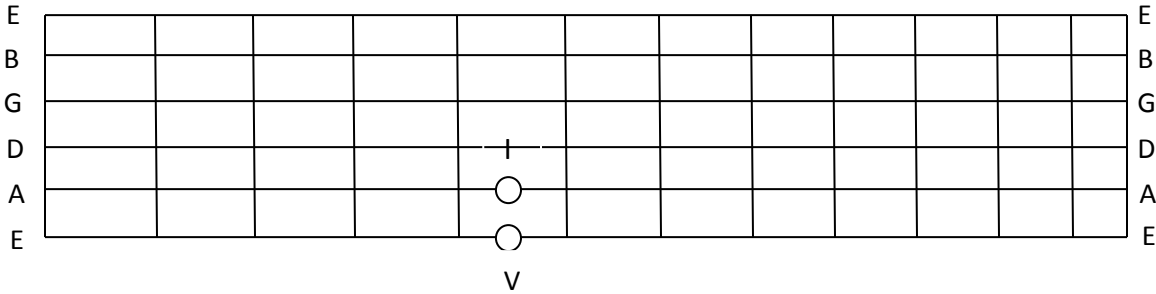

Image 114

If the opposite occurs and we have a V on the 5th string (anywhere on the fretboard and regardless of the key) the I will be on the 6th string two frets lower – to the left from the player’s perspective:

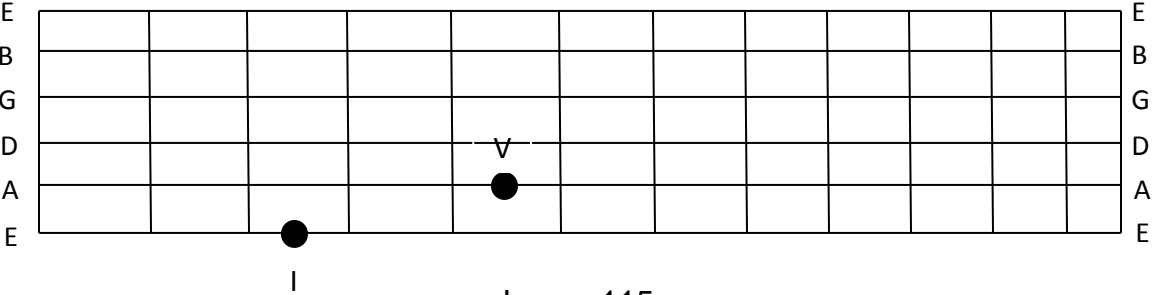

Image 115

With a simple understanding of octaves we can then translate this knowledge to the fourth string, giving us further possibilities for playing and visualising the progression:

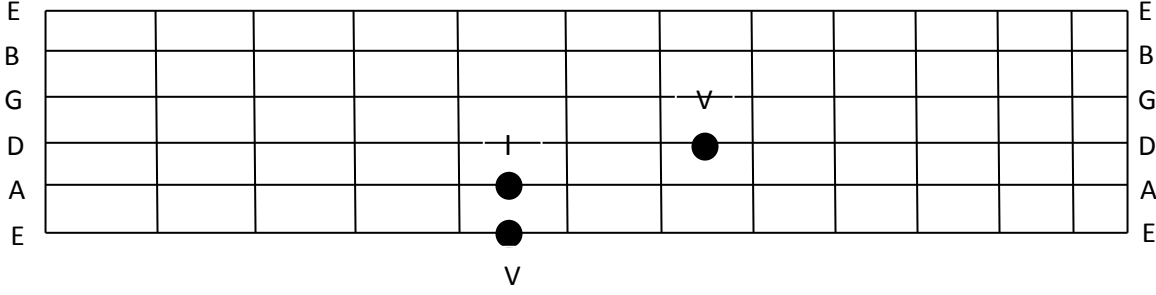

Image 116

And...

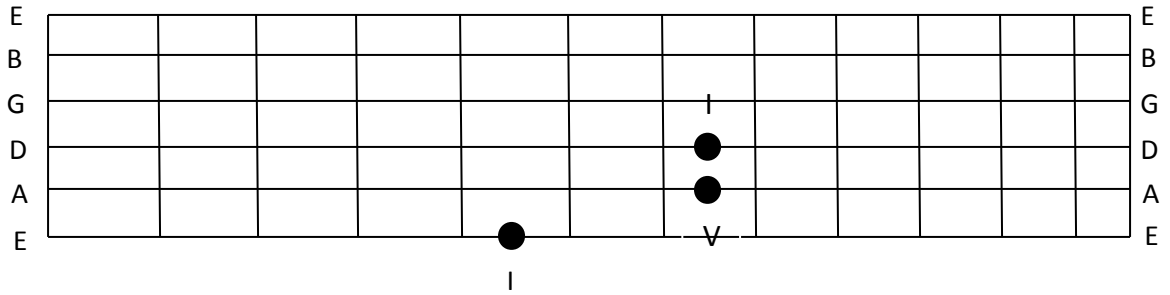

Image 117

*Through this understanding, we can not only acquire a valuable visualisation on the guitar fretboard of what is possibly the most common progression in music, but we can also start to understand how to find any given chord transition which happens to move an interval of a fifth away, regardless of whether it involves the V or I of the given key. In other words- the V chord is seven semitones away from the I chord, therefore any other chord progression that moves from a given chord to a chord seven semitones away can be played with the same visualisation of rootnotes on the fretboard. This actually happens a lot, as the major scale patterns demonstrate below:*

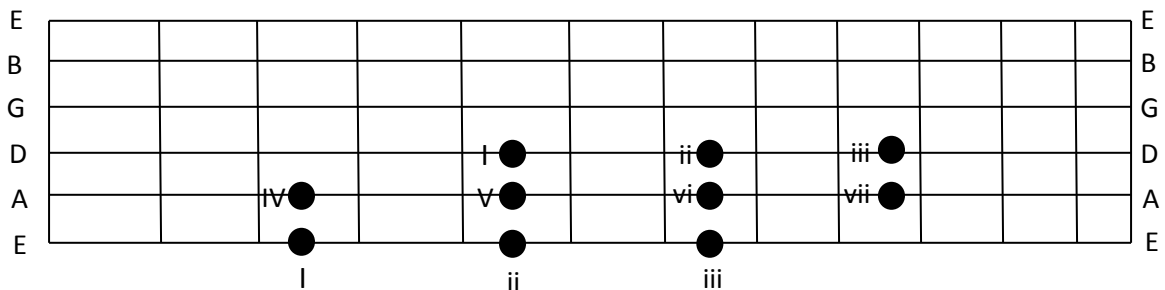

Image 118

Or...

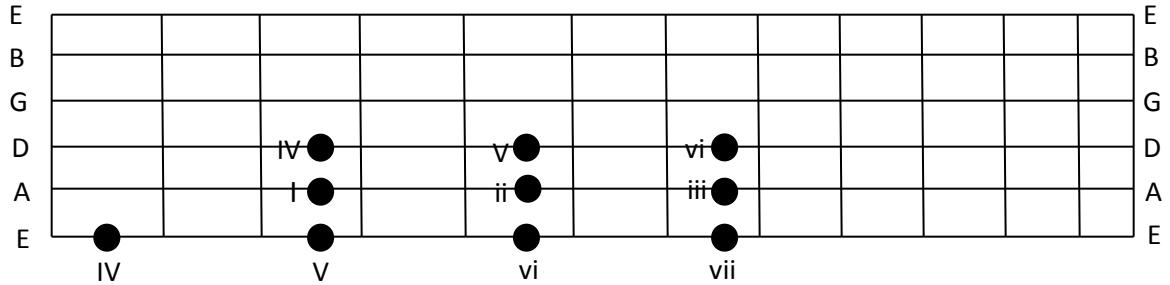

Image 119

*Of course, as explained throughout these studies, any note on the guitar can be played in several places, including in the same octave for most cases, which means the student should continue applying these principles of rootnote visualisation to the remaining positions, which will also become useful and (most importantly) moveable-applicable to any key . For example, if a I is on the 6<sup>th</sup> string, we know we can always find the V on the 5<sup>th</sup> string two frets higher. However, we can also always find it three frets lower on the 3<sup>rd</sup> string:*

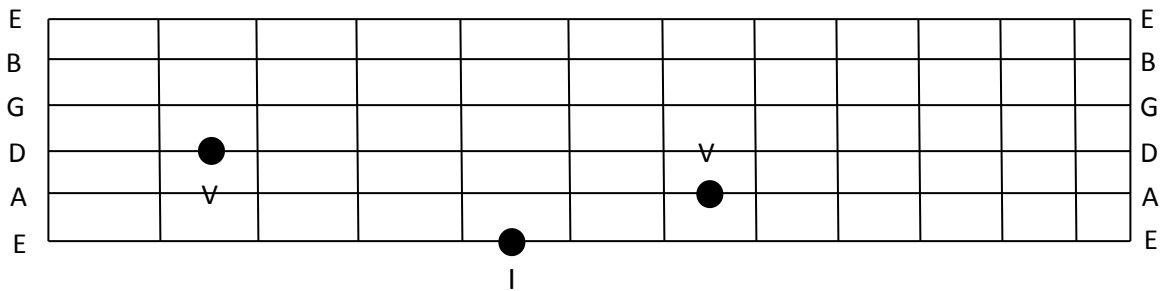

Image 120

As we can repeatedly see in this and several other lessons, whilst having the disadvantage of needing to learn several different locations on the fretboard for almost any single note at any given octave, we as guitarists (and unlike many instrumentalists) at least have the advantage of being able to repeat the same shapes and patterns to play any scale, chord or arpeggio in different keys.



Nonetheless, by looking at the guitar neck it is easy to see how the frets get narrower as they get nearer the body of the instrument, and wider as they get near the headstock. Likewise, the marker dots which are used to guide the player to identify specific fret numbers easily will appear under a different finger depending on the key that we play any given pattern or shape. For these reasons, as well as to help in the memorisation of notes and harmonic patterns, it is very important to take common material through the 12 diatonic keys.

A good way to do this, which also helps with the memorisation of all keys and the relationship between them, is to follow the *circle of fifths*:

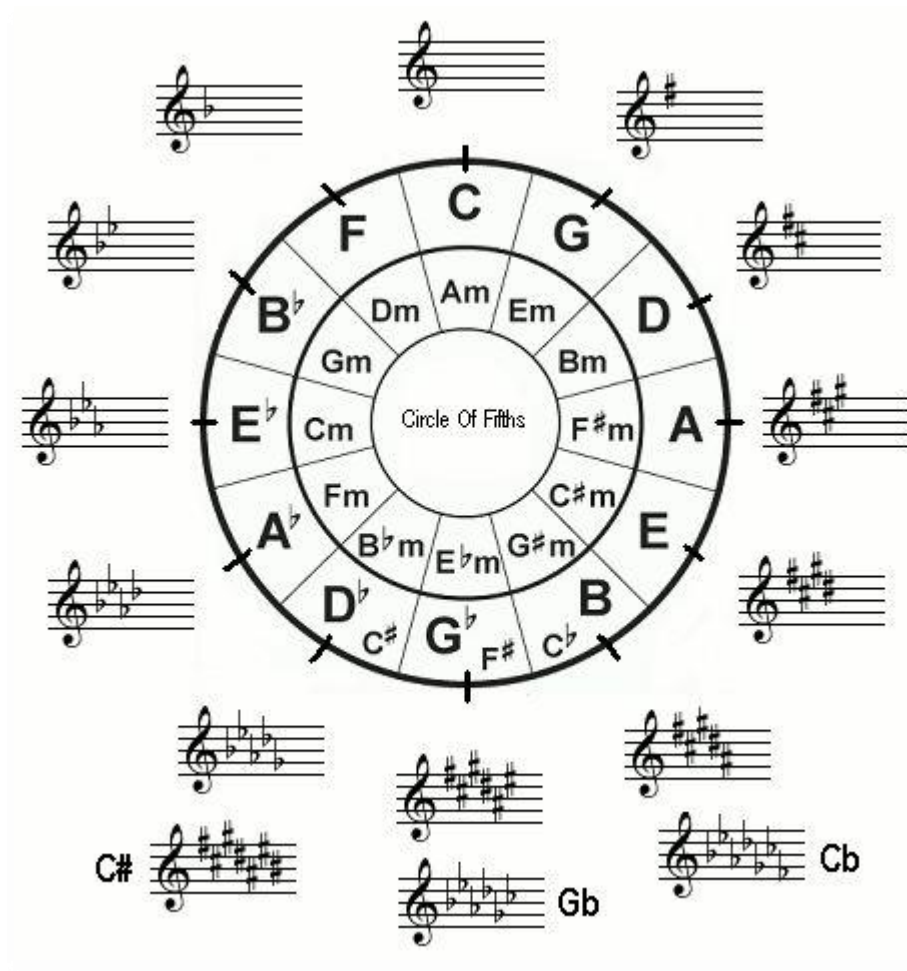
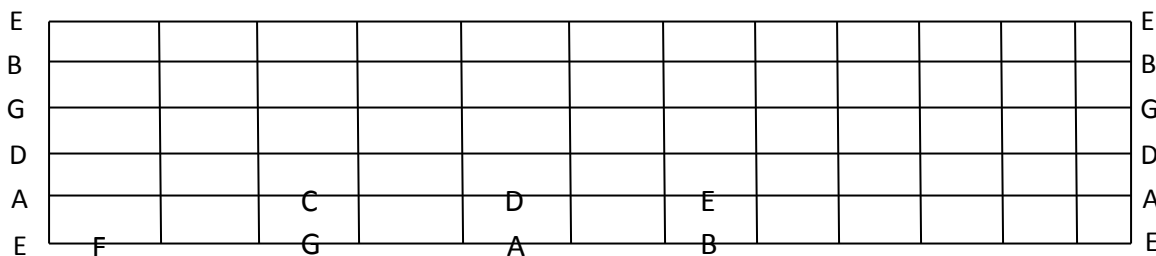

Image 121

The circle of fifths presents all keys and their respective relative minor keys in order, from C major/A minor, with no sharps or flats, at the top; to Gb major/Eb minor, with six flats (or sharps if looked at as F# major/D# minor) at the bottom. On the left, gradually appear all of the keys which have flats in progressive order (i.e. key with one flat, then key with two flats, then key with three flats, etc). On the right gradually appear all of the keys which have sharps also in progressive order (i.e. key with one sharp, then key with two sharps, then key with three sharps, etc). The circle can of course also be presented with all the exact same information appearing on the opposite sides (i.e. with sharps to the left and flats to the right), and is indeed sometimes presented in that way.

The system does this by moving in intervals of a perfect fifth (hence *circle of fifths*) for each new key on the sharps side, and in perfect fourths for each new key on the flats side. This makes it easy to see which major and minor keys are most closely related to each other, in terms of their respective sharps or flats, as well as making the study of any given pattern over all keys structured. By selecting any scale, chord, or arpeggio and taking it around the circle of fifths, the guitarist will also discover a visual pattern which is very much directly related to the root notes and intervals presented earlier. After all, the *circle of fifths* is based in intervals of a 5<sup>th</sup>, and by following it around we will land on each new key by travelling the same distance as a I –V chord progression (seven semitones):



And...

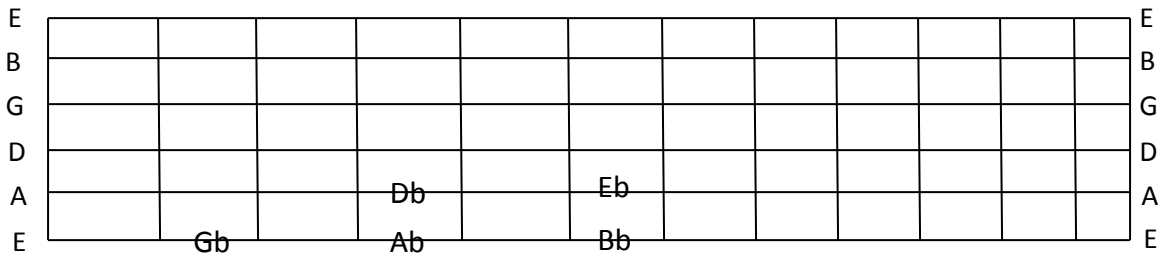

Image 122

*As an extension on the previous exercise, try now playing the same common chord progressions in the key of C, and then follow the circle of fifths towards its fifths side (i.e. key of C, then key of G, then key of D, then key of A, etc) until completing all twelve keys. Later on expand this to any important chord progression you learn.*

- 1) *ii – V – I*
- 2) *I – vi – ii – V – I*
- 3) *I – IV – V*
- 4) *I – vi – IV – V*

## **LESSON 10–Chord arpeggios and the melody-chord relationship**

Chord arpeggios result when we play the notes of a chord melodically. They can indeed serve as useful and productive technical exercises. However, in composition and improvisation they form the platform from which we construct melodies with an awareness of which notes will be most consonant over the harmony, and they play a big part in allowing us to have control over how much tension we add to the music and how to release it. If we are playing notes drawn exclusively from any given chord's arpeggio, the melody will be highly consonant. However, as we start adding the remaining notes from the scale outside of the basic chord, new colours and tensions can be introduced, and beyond this, chromatic (or non-key) notes can also

be used to add extra tension. In music composition, arranging and improvising, we look for an interesting balance between **tension** and **release**.

Productive use of these principles demands considerable technique, but for now the most important thing is to know the arpeggios of the most important chord types. In contrast to some of the chord shapes on the guitar, where we don't tend to play the chord formula in order (i.e. Root, 3<sup>rd</sup>, 5<sup>th</sup>, 7<sup>th</sup>), here we will play the arpeggios exactly as the chord formulas suggest. Remember, the formulas for the arpeggios are exactly the same formulas as that of the chord to which they correspond. This means that, exactly as in the case of the chords and scales, you can **reposition** them with any scale shapes and in any key.

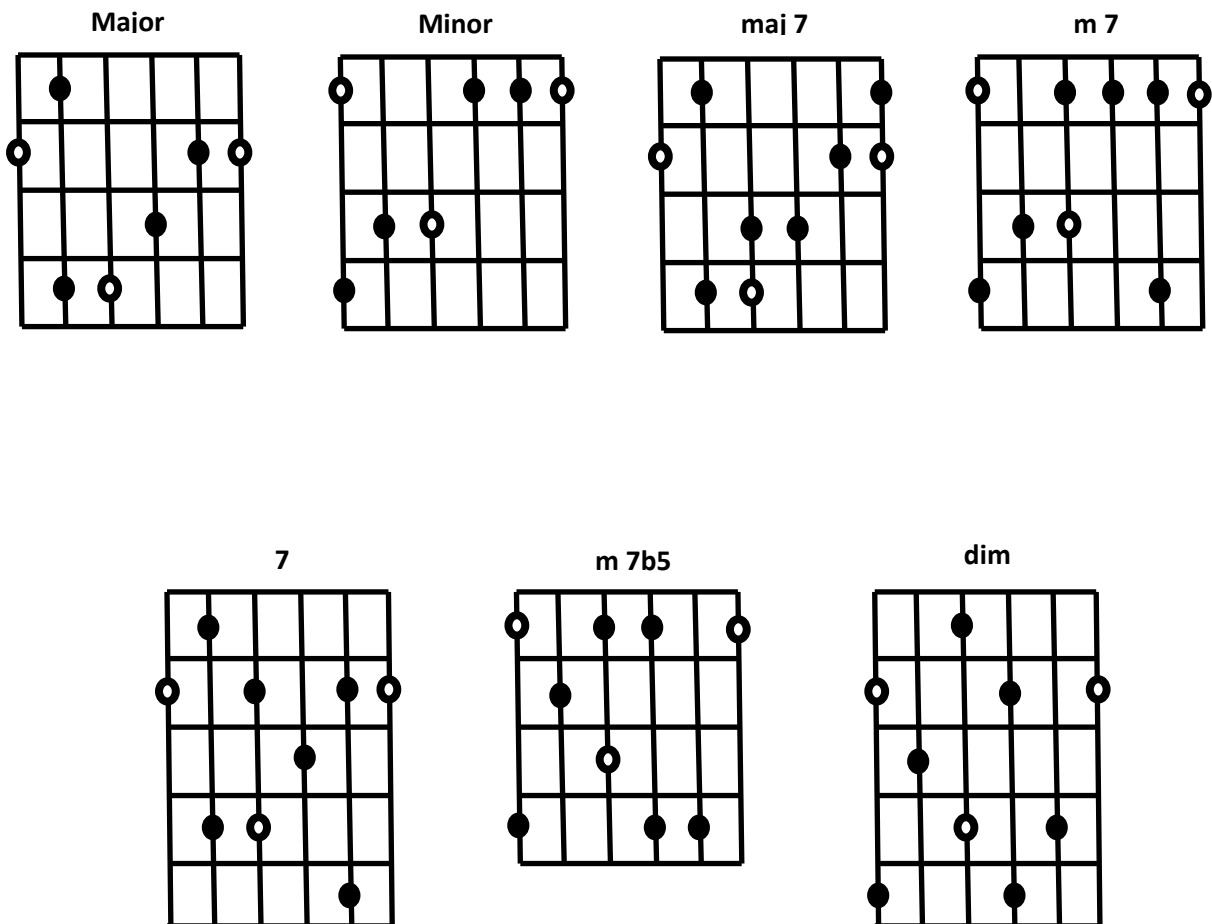

Image 123

## LESSON 11 – Internally modelling the fretboard through a process of mental imaging and the use of the CAGED system.

This chapter is an introduction to a system used by many guitarists to assimilate and memorise information related to the instrument in a visual way. It can indeed be used, and will provide significant help, with the task of mastering all of the scales, arpeggios, chords and intervallic patterns presented previously through these chapters.

The system is called the CAGED system, which refers to the five open major chords that appear on the guitar in the open position: C, A, G, E, D. Importantly, the system uses the *shapes* of these chords (as opposed to the chords themselves in those specific keys), to present and simplify the understanding of how major triads (and later, through them, more complicated note families) appear throughout the guitar neck.

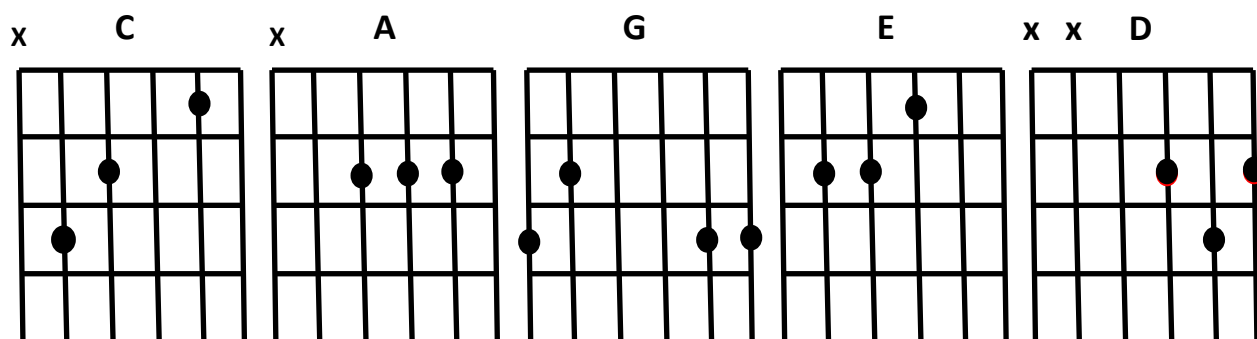
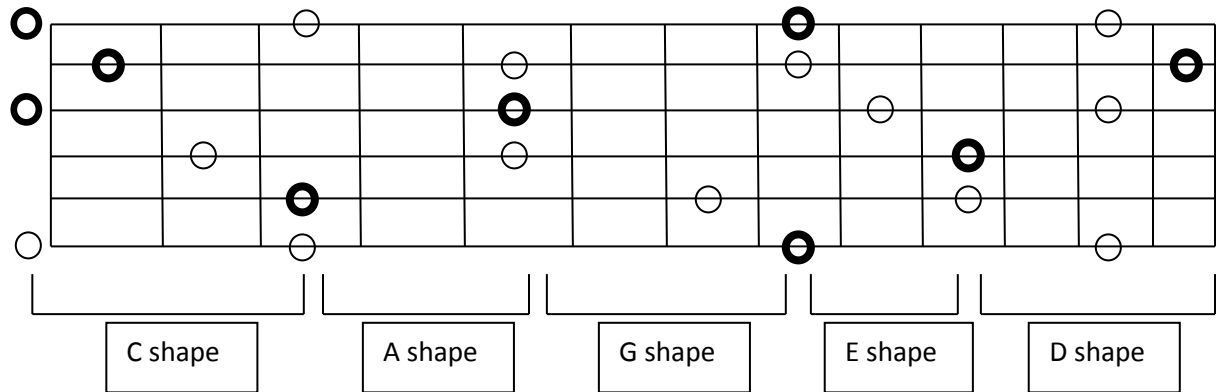

Image 124

These simple chord shapes in this particular order reveal how the notes that constitute any given major chord/triad will appear (and reappear) throughout the guitar neck from its low to its high end. Starting from any of the shapes (not necessarily in their original key) the notes of the same specific chord will then reappear following the CAGED sequence of shapes from that point, i.e. if we start from the G shape on a G root note, the notes of the G major triad will then reappear

in an E, D, C and finally A shape. The diagram below provides a visual example of how this would apply to the C major chord/triad (all of the shapes below are C major chords, played through the use of the CAGED shapes):



○ = repeated triad note below root note (optional in performance)

● = root note

Image 125

The main implication for practical purposes is that as the player takes the shapes beyond the open position, a bar (or barre') is required in order to serve the purpose which the guitar nut serves in the open position.

For example, a C shape beyond the open position will look as follows:

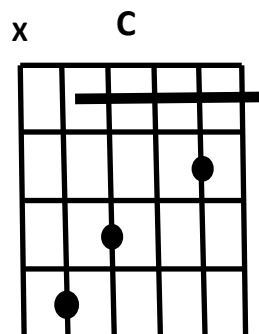
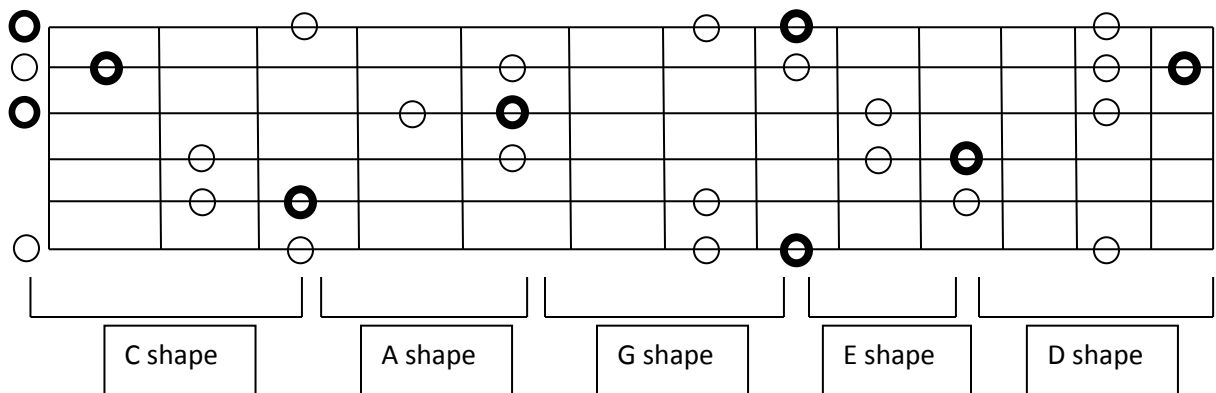

Image 126

As with the study of music itself, we can base our analysis and understanding of more advanced concepts by relating them back to the basic triad. For example, from a major triad we can obtain a minor triad by flattening the third, we can also obtain a major seventh chord or arpeggio by adding a further major third interval from the fifth of the major triad, etc.

Through this basic understanding of how triads appear on the guitar neck we can constantly relate everything we learn back to it, gradually creating a mental image of the way in which the structure of music appears on the guitar fretboard. This is an invaluable tool that provides the guitarist with a visual approach to the instrument which gets closer to that which is offered by the piano.

As a further example, below is the construction of C major seventh chords/arpeggios through the cage system – by adding the interval a major third from the fifth (the B note):



○ = major 7<sup>th</sup>/note a major third from the 5th

Image 127

## Lesson 12 – The concept of eight-note scales as a way to control the flow of tension and resolution

Apart from the essential scales and arpeggios that have been presented in these lessons so far, there is the concept of eight note scales. Eight note scales (also known as *bebop scales*) evolved during the transitional period between swing and bebop, exactly when jazz moved from being a type of popular music used mostly for dancing to becoming a more intellectual and formal musical form concerned with a deeper understanding of advanced harmony and its application in composition and melodic construction.

The reasoning behind the creation of the eight-note scales (or *bebop scales*) originates in the rhythmic and timing aspect of music. The most important mission of the bebop improviser was to delineate the chords of the composition melodically. Additionally, the down beats of the bars, which are stronger, were frequently used for playing these chord notes in order to further-enhance their effect in establishing the harmony.

Nonetheless, when playing seven-note scales (such as any of the ones mentioned so far in these lessons) from start to finish, the resolution back to the tonic happens on an upbeat. In order to resolve this, improvisers added a chromatic note to the scale, which would then turn it into an eight-note scale, allowing the resolution to the tonic to then happen on a down beat.

The dominant chord was (and is) at the centre of the jazz idiom as a whole, being the key chord during which most of the excitement is produced during blues and ii-V-I oriented chord progressions. For this reason, the eight-note scale first developed around this chord. By adding the chromatic note between the seventh degree and the octave, the regular scale used over dominant chords – the mixolydian scale – was transformed as follows (key of C as an example):

Original dominant scale (mixolydian scale): C – D – E – F – G – A – B $\flat$  – C

Eight-note dominant scale (bebop scale): C – D – E – F – G – A – B $\flat$  – **B** – C



By doing this, not only does the scale resolve back to the tonic on a down beat, but all the other vital chord notes remain on down beats as well. This wouldn't be possible if the chromatic tone was added at other points within the scale.

*The scale can be achieved by simply adding the new chromatic note to the mixolydian shape learnt previously:*

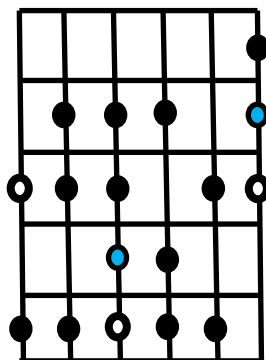

Image 128

*Try improvising over a static dominant 7<sup>th</sup> chord with this scale. In order to hear the effect of the scale at its best and without much effort, start by playing phrases consisting of diatonic seconds, and start lines from chord tones. Listen to the way the scale achieves balance between the tension of chromaticism and the consonance of the chord notes on the down beats.*

Additionally to the dominant eight-note scale, other *bebop* scales developed for use over other chord types. The harmony of jazz during the time of swing and bebop was also highly concerned with the use of 6<sup>th</sup> chords. This can easily be perceived by

opening any collection of lead sheets of jazz standards of the time, where they are not only frequently used but commonly applied to endings. For this reason the eight-note scales corresponding to these chords not only achieve the goal of resolving to the tonic on the down beat, but also make sure that the sixth degree also appears on a down beat (and sacrifice the 5<sup>th</sup> and 7<sup>th</sup> appearing on such beats at times), as can be seen below:

Major/Ionian eight-note (*bebop*) scale: C – D – E – F – G – **G#** – A – B – C

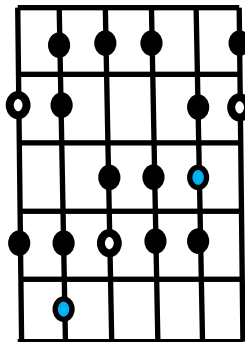

Image 129

Minor/Dorian eight-note (*bebop*) scale: C – D – Eb – **E** – F – G – A – Bb – C

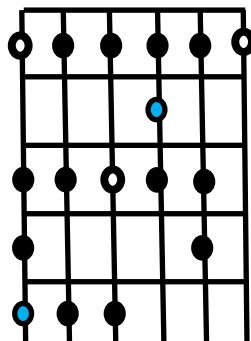

Image 130

Minor 7b5/Locrian eight-note (*bebop*) scale: C – Db – Eb – F – Gb – **G** – Ab – Bb – C

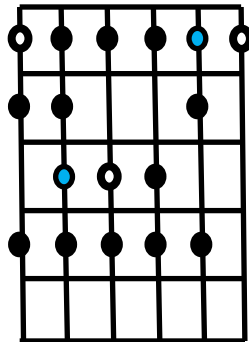

Image 131

### **LESSON 13 – Embracing spontaneity (the value of reacting to the present moment)**

As a final lesson in this introduction to jazz principles, we will look at one of the most important features of jazz music - responding spontaneously to the moment. Jazz players not only play any piece differently every time (at times even changing the form, depending on the subgenre), they also embrace the fact that each performance is intended to be unique. They do this by listening to the subtle characteristics of

each player's sound at any given moment in a performance, and playing something that they consider will complement it, or interact with it in an interesting way.

Similarly, in solo performance, they listen to the spontaneous characteristics of their own playing at any given time and react accordingly to those. Of course, as a genre, jazz is a vast field where many different branches have different approaches to certain aspects of playing. For example, in big band playing, instrument sections often play several passages in a more traditional, thoroughly pre-planned (and rehearsed) way – as there are frequently meticulous arrangements to non-solo sections. However, in general the principle of spontaneity and reacting in the moment to the musical environment is at the core of jazz as a style, and the development of a player's skill.

Even though other styles of music such as classical do not feature improvisation that involves creative output in melody, harmony and rhythm in the same way, the essence of spontaneity can nonetheless often be translated between genres for positive effect, but too frequently it isn't. For a solo piece of music which is rehearsed from start to finish (such as most classical pieces) this can be translated to the application of articulations, dynamics, tempo alterations and rubato. As stated by Julian Bream and quoted at the beginning of this chapter, the atmosphere of the now can be created through interpretation - with the spontaneous use of tempo, dynamics, articulation and colour- even if in other aspects the piece has been pre-conceived.

#### **Lesson 14 - Applying technological advances to potentially extend notions of timbre and volume**

The concept of technology is generally speaking involved in both the classical and jazz guitar in different ways. Apart from during the recording of material and the use of microphones (more recently also pickups) and PA equipment in large venues, in the classical style technology is traditionally related to the construction and efficiency of the acoustic instrument itself.

The general design for the classical guitar as we know it today was conceived in the second half of the 19<sup>th</sup> century. Previous to that, the body of the instruments used to be much thinner and in general they used to be smaller, producing a less rich and powerful sound (as described in the Historical Context chapter). The most famous luthier of the period, who is usually credited with the development of the modern classical guitar, was Antonio de Torres Jurado (1817-1892). He is also renowned for constructing the guitars used by Francisco Tarrega, the most celebrated classical guitarist of that period.

The 20<sup>th</sup> century then saw an evolution of this basic model into guitars that were more resonant, clear and richer in tone and frequencies, whilst maintaining its general design, shape and dimensions. Jose Ramirez, Hermann Hauser, Ramon Blanco and Greg Smallman are amongst the most important luthiers to refine the construction of the classical guitar in the 20<sup>th</sup> century and into the 21<sup>st</sup>. Andres Segovia, Regino Sainz de la Masa, Alirio Diaz, John Williams and Milos Karadaglic are amongst the players to use these luthiers' instruments.

John Williams stands out as a major classical player to emerge in the middle of the 20<sup>th</sup> century and to embrace electronic technology beyond what was common, or generally considered appropriate, at the time. He incorporates an installed electronic pickup into hand-made classical guitars "I always think that in the end, technology and experimentation with equipment can deliver the goods. Traditionally, classical guitarists have thought that all kinds of amplification were crude and bastardizing. They thought that it might be sacrilege to stick a pickup in a great guitar like a Smallman. To my mind, it's on the contrary: If a system is really good, there's even more reason to have a better guitar for it. I think it just goes to traditional prejudice that somehow it's corrupting the pure sound and all that" (Williams, 2005).

*Opportunities to consider for classical guitarists*

The purpose of this segment follows closely the general approach of this research project: it is designed for people who are interested in the future development of the guitar, more so than those interested mostly in its traditional practice. It is the intention to inform the classical player of ways in which they can experiment with electronic technology for the purpose of processing sound, as well as amplifying it. How much the sound deviates or changes from a traditional classical sound is ultimately down to the individual. The application of classical principles for production and refinement of tone will underlie any sound manipulation used thereafter regardless, as demonstrated on the DVD which accompanies this thesis.

### *Amplification*

The use of electronic equipment to make the sound of the guitar louder is today common practice. The vast majority of ensemble or orchestral work which incorporates the guitar (particularly in lead roles) will most frequently need the instrument's natural gentle volume as compared to others to be enhanced, as will solo performance in large venues. The use of external microphones is the most, now traditional, way of achieving this.

Nonetheless, following Williams approach, classical guitars with pickups are now also common, allowing the guitarist to connect the instrument directly into amplification systems. These pickups can be in-built, forming a part of the guitar's original design, or can be removable (such as under-saddle pickups and piezo pickups –which can be placed in different areas). These microphones sense the vibrations produced by the strings through having direct contact with the instruments wood. The serious classical guitarist will be aware of this and of possibilities available in terms of equipment. Nonetheless here are some interesting and high-quality recent amplifiers developed by companies at the forefront of acoustic

amplification technology. These amplifiers work whether the guitar's sound is taken through an external microphone, an in-built pickup, or a removable one.



Fishman Loudbox Mini amplifier – Image 132

The Fishamn Loudbox Series comes in three different sizes to offer different possibilities for volume, inputs and effects (which include delay, reverb and chorus). The amplifier incorporates 3-way speaker technology, helping the sound to reach all corners of performance venues.



Roland AC-90 Acoustic Amplifier – Image 133

This Roland amplifier is the newest model for acoustic instruments to date by the company. It offers 90 watts, possibilities for stereo sound, anti-feedback features, as well as effects such as reverb, delay and chorus.



Fender SFX Amplifier – Image 134



The Fender SFX amplifier is designed with particular care in protecting the acoustic qualities of the sound. It is aimed at performing musicians who are after light-weight equipment; offers effects such as reverb, delay and chorus and has three separate speakers aiming for a rounder sound projection.

Ultimately, like the choice of a guitar itself, which combination of electronic equipment to use needs to be a personal decision. Nonetheless, as can be seen, there are now several options for the amplification of acoustic instruments in ways that are reliable and minimise the risk of compromising the sound.

### *Timbre and tone*

This is one of the most important and refined areas of knowledge in the classical style. The pureness and richness of sound achieved through good classical plucking is unique and basically just as important for the successful performance of the music as the notes in any given composition itself. With this in mind, it is not surprising that the majority of classical guitarists traditionally do not incorporate electronic equipment to process the natural sound of the instrument. But perhaps most importantly, as with most classical performers, the majority of classical guitarists do not write music for the instrument which they play. This also leads to a lack of necessity for experimentation with effects, since the compositions they play are designed to be played without any sound-processing. In addition, the classical tradition is normally conservative with regards to making sure that the aesthetic and artistic vision of the composer is respected in performance. In jazz, on the other hand, drastically different arrangements and interpretations of standards are common practice.

Nonetheless, as mentioned above, the tonal richness derived from the classical approach to the stroke will not be lost through the use of technology, much like a

good take of recorded material will not lose the quality of the performance once its sound is electronically equalised or processed. Similarly, a stroke with poor tonal quality can only be 'cosmetically' helped through the use of electronics, whilst its actual quality not changed.

For the classical guitar to incorporate sound processing and effects more actively into its practice, other than the option of applying it to traditional pieces in experimental ways, there is a need for it to be part of the conception of new pieces in the first place. An example of the kinds of things that can be possible is the piece 'Much More' by Walter Rodrigues Jr (2011). Although not a classical guitar piece in terms of its approach to harmony, rhythm and general compositional style, the piece incorporates the classical instrument and its full technical approach to sound and tone refinement. In addition, Rodrigues Jr uses an electronic loop pedal to record certain parts as he plays and subsequently plays other parts alongside. Another example of the use of this type of technology is a series of two untitled free improvisations by classically-trained guitarist Christiaan de Jong (2016), in which he utilises a series of delay and pitch-alteration effects.

The types of results obtained in these examples on the sound of the guitar demonstrate that the tonal qualities achievable through classical technical approach are not automatically compromised as soon as the sound is processed. The tonal richness of the basic strokes remains unaffected, whilst the technology adds a new element to the realm of possibilities that the guitar has.

### **Lesson 15 – Tackling the issue of playing fourths on the guitar, and Robert Fripp's *Paganini finger wobble*.**

Regardless of the style, almost all guitarists eventually experience the awkwardness of having to play intervals of a perfect fourth on the instrument (and between the second and third string of the instrument - major thirds); in other words the note on the string directly below or above another note, and on the same fret.

This is because in order to lift one given finger from a note to relocate it on an adjacent string on the same fret inevitably results in the sense of legato or continuity being interrupted during the time the finger takes to move. Similarly, the use of a separate finger to get to the note (directly above or below on the same fret) most frequently causes the overall position and posture of the hand to be broken in a way that then affects the preparation of fingers for the passages to follow thereafter.

In order to counter this, most guitarists use the concept of finger *flattening* and *unflattening*, whereby the finger either: plays the note normally and then is flattened onto the string directly below in order to play the note directly (a fourth) below:

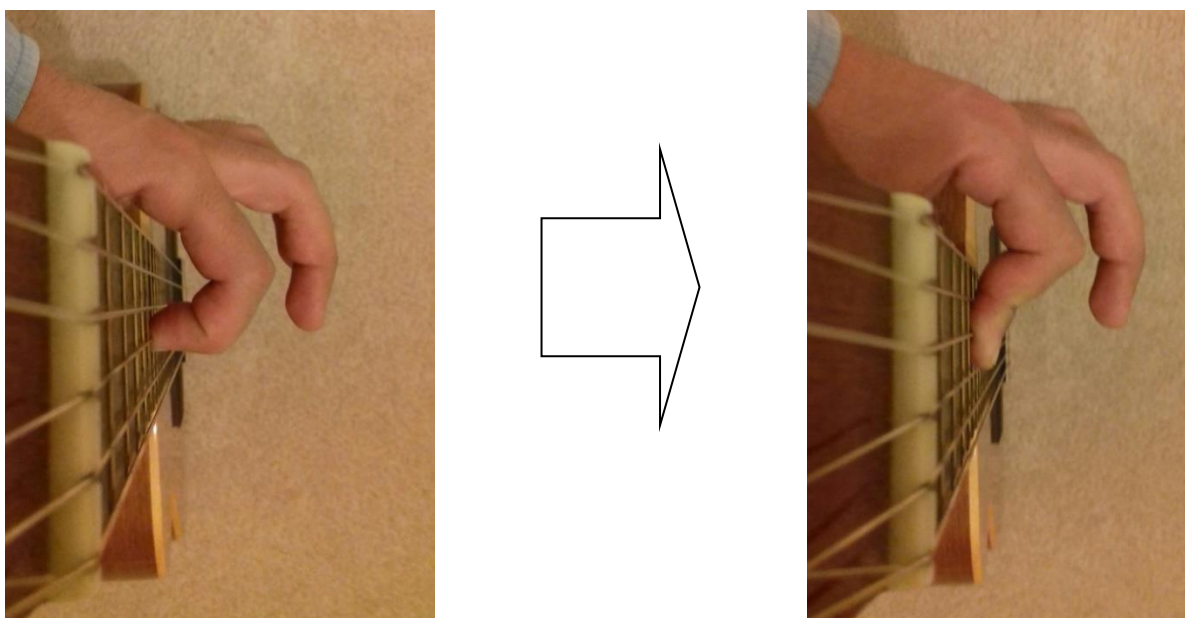
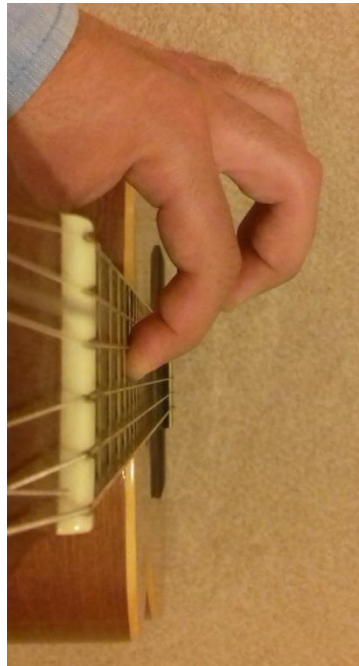

Image 135

Or inverts the above in order to play the note directly (a fourth) below.

Inspired by Paganini's violin technique, however, jazz/rock progressive guitarist Robert Fripp put into use an interesting approach which enabled him to achieve the same effect whilst avoiding the uncomfortable and unnatural movement which the finger has to make when employing the technique above. He placed the finger exactly in-between the two strings, and then rotated it (much more subtly) up or down, with the help of the arm and wrist in order to reach either the note above or below:



OR

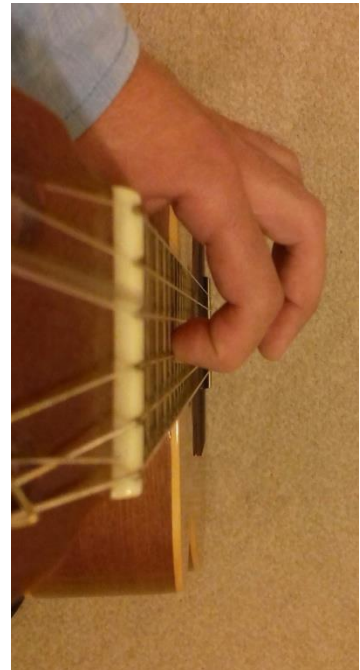

Image 136

This technique can indeed be used in basically any style and, developed with patience, can contribute towards refining a player's efficiency on the strings. Nonetheless, the usually slightly bigger area between strings on a classical guitar, compared to that of electric or steel string acoustics, can require a little more rotation and movement from the fingers. Each player's unique hand and finger dimensions will also have an effect on how easy or difficult this technique can be to apply.

**DVD – Demonstrations of some of the most important concepts described in  
this conclusion**

## **Appendix 1**

### **Interview list and audio files disc**

I have undertaken twenty interviews with guitarists. Seventeen of these have been audio recorded and are provided in this appendix on a disc of mp3 files. The remaining three interviews were done via email and are transcribed in Appendix 2.

#### **Interview list**

- Martin Taylor (jazz) Interview via email, please see transcription in Appendix 4.
- David Bainbridge (classical) Interview via email, please see transcription in Appendix 4.
- Brad Edmondson (jazz) Interview via email, please see transcription in Appendix 4.
- Craig Ogden (classical) mp3 included
- Daniel Brew (jazz) mp3 included
- David Oakes (classical and jazz) mp3 included
- Anton Hunter (jazz) mp3 included
- Sam Rodwell (classical) mp3 included
- Adam Palma (jazz) mp3 included
- John Harper (classical and jazz) mp3 included
- Paul Cusick (jazz) mp3 included
- Steve Davismoon (classical) mp3 included
- Stuart McCallum (jazz) mp3 included
- Emma Smith (classical) mp3 included
- Jim Faulkner (jazz) mp3 included
- Alfredo Rugeles (classical) mp3 included
- Matthew Campbell (jazz) mp3 included
- James Girling (classical and jazz) mp3 included
- Alan Williams (jazz) mp3 included
- Jamie McRae (classical) mp3 included

**Interviews – mp3 audio files disc**



## Appendix 2

### Interview with Martin Taylor

**1- How did you start/what was your general process of development as a guitarist?**

I started playing the guitar in 1960, and I'm completely self-taught, so I never had a tutor to guide me on this. In the very early years the guitar was just a toy that I played with. By the time I reached the age of eight I became very interested in playing music, so I just listened to the radio, or my father's records, and played along to them. It meant I developed a very good ear, and could always pick something up very quickly. I only had to hear something once, and I could play it. In my early teens I decided that I wanted to pursue a career in music and was already playing in my father's band at dances. I learned a large repertoire of popular songs and would practice them so I could commit them to memory. I couldn't read music at this time, so I had to commit everything to memory. I learned to read music much later. I don't have a practice routine. I just work on my repertoire. I've been playing for so long now that I don't feel the need to physically practice, although I am always thinking of new ideas and how I can play them on the guitar. I practice a lot in my head.

**2- Would you change/do anything differently, if you could go back, about the way you have learned and the things you have practiced?**

I'm grateful for the fact that I learned first by ear, and then learned to read music later, but I wish I had studied orchestration. I would have loved to write music and arrange for an orchestra.

**3- Have you ever come in contact with the classical school of playing? What do you know about it?**

Yes, I've played many classical guitar festivals around the world over the years, and have collaborated with several classical guitarists including Carlos Bonel, Simon Dinnigan, Badi Assad and Jorge Morel. I don't know much

about the classical school of playing, although I am quite familiar with the more popular classical repertoire. I've never played classical guitar.

**4- Between jazz and classical, which of the two styles do you think is more demanding and why?**

They are both very demanding in their own ways. A big part of a classical musician's job is to bring to life the music of the composer, and to respect how the composer wished that music to be played. A jazz musician gives their own interpretation of a composer's music. In fact, we are supposed to interpret it differently every time we play a piece!

They are both interpretative and creative, but in different ways. However, from experience it seems to be harder for a classical musician to play jazz than the other way around.

**5- Do you think there is good communication between the classical and jazz genres? If not, how can we improve it?**

I can only speak from my own experience. The way I play solo jazz guitar is actually more related to classical guitar playing than jazz playing. I play fingerstyle, and incorporate many moving lines. The only main difference is that I improvise on those individual lines. I have the ability to move them around. Most jazz guitarists play single lines with a pick, very few play fingerstyle and even fewer play solo. Most jazz guitarists seem to look at the classical guitar as a completely different instrument. I'm not sure if classical guitarists feel the same?

**6- Do you think it is important for classical players to understand the harmonic and compositional components of the music that they play?**

It's important for all musicians to understand how the music they are playing is constructed. I spend a lot of time with my students getting them to identify what they are playing rather than just knowing where to put their fingers like a robot. It's a problem that both classical and jazz players seem to have. I think

the rise in TAB has caused a lot of these problems among non-classical players. They just learn mechanically where to put the fingers.

**7- Which of your stages of development has been the most difficult and why?**

When I started to specialize in solo guitar my musical ideas were way ahead of my technical abilities as a guitarist, I got most of my inspiration from listening to jazz piano players and tried to emulate the way they played, but I just couldn't play the guitar well enough to execute my musical ideas. So, I had to improve as a guitarist. I took much of my inspiration from listening and watching classical guitarists and how they really got into the detail. How to produce a good tone, get into the centre of the note, and how to use dynamics.

**8- Do you think that jazz players could benefit from having a more standardised technical approach to the instrument based on tested approaches to obtain the most refined tone, tone control and technical efficiency?**

There is a kind of standardisation going on at a number of jazz schools, but I don't think it is necessarily a good thing for jazz. It seems to stifle individuality, so many young players end up sounding the same. However, I certainly think jazz guitarists can benefit greatly by studying how classical players produce tone and dynamics. With jazz guitar it's not always necessary to have an incredible technical command of the instrument. What the jazz musician creates within their own technical limitations is far more important than being a virtuoso. Unfortunately for me, my musical ideas are quite complex which is why I had to develop a higher level of technical ability. I guess I made hard work for myself!

**9- Do you think classical players could benefit from having a more practical understanding of harmony, and that this should be more integral to classical teaching?**

All instrumentalists should have a good understanding of harmony, and how music works. Otherwise, they're just playing mechanically and not understanding what they are playing. They're just putting their fingers where the notation or TAB is telling them. It's like painting by numbers. It's not musical.

**10- Have you ever attempted any classical pieces? What did you conclude from this experience?**

No, I'll leave classical guitar to the experts!

**11- Do you think it is possible to play both styles at a high level?**

I've never heard a guitarist who could play both at a very high level, but I'm sure it's possible, and I'm sure someone will come along and astonish us in the future. I certainly hope so!

## Interview with Brad Edmondson

**1- Since you started as a guitarist, how much of your practice has been set up by you, how much by a tutor?**

Probably a 50/50 split. The tutor gives exercises/concepts etc and I tackle these in my own way and at my own pace.

**2- Would you change/do anything differently if you could go back, about the way you have learned and the things you have practiced?**

Yes I would. I'd like to have been exposed to the things/concepts/practice strategies I've been doing in the past few years much earlier on in my development as a guitarist.

**3- Have you ever come in contact with the classical school of playing? What do you know about it?**

I have not really been exposed to the classical school of playing that much. I have a friend who studied classical guitar at the RNCM (after a couple of years studying pop/jazz) but unfortunately that's as far as my experience goes.

**4- Between jazz and classical, which of the two styles do you think is more demanding and why?**

I think both are as demanding as each other for different reasons. Whilst there is increasing crossover between the disciplines, I think the history/development of the styles require different approaches and to a certain extent, different ways of learning them.

**5- Do you think there is good communication between the classical and jazz genres? If not, how can we improve it?**

In my experience I think there is a definite lack of communication between the classical and jazz genres. I think classical and jazz guitarists should make more of an effort to collaborate in both composition and performance, which should in turn hopefully improve communication between the genres.

**6- Do you think it is important for classical players to understand the harmonic and compositional components of the music that they play?**

Yes.

**7- Which of your stages of development has been the most difficult for you and why?**

Perhaps the stage that I'm currently on. I feel as though I've had to re-learn the instrument somewhat in order to develop a more expressive voice on my instrument. Whilst I had a lot of technique, I realised my fingers were leading me the way. I wasn't connected to the music and couldn't make truly informed choices about what I wanted to say on my instrument.

**8- Do you think that jazz players could benefit from having a more standardised technical approach to the instrument based on tested approaches to obtain the most refined tone, tone control and technical efficiency?**

Yes absolutely.

**9- Do you think classical players could benefit from having a more practical understanding of harmony, and that this should be more integral to classical teaching?**

Yes.

**10- Have you ever attempted any classical pieces? What did you conclude from this experience?**

Yes I have. My experience was that for me, it is another lifetime worth of study in order to give the style the respect it deserves. I find it is a very different discipline to tackle, to a certain extent technically, but mostly due to groove and time.

**11- Do you think it is possible to play both styles at a high level?**

Yes, to a certain extent. There will be (or already are) individuals who can do this. However, one person's high level can be another person's average etc, so the term 'high level' needs to be defined in a clearer way and put into a situation/context. To the average listener/developing musician, a world-class jazz guitarist may seem like a phenomenal classical guitarist. However to classical guitar aficionados, this may very well not be the case. And the opposite is true of course!

I think it is interesting that, to my mind at least, I can't really think of any guitarists that are known for being totally convincing in both styles and are completely celebrated by both audiences. That's not to say it can't happen, or already hasn't!

## **Interview with David Bainbridge**

### **1- How did you start/what has been your general process of development through the years?**

I went to a private tutor before going to Cheethams School of Music. I always had an open minded approach, being interested in different genres.

### **2- Is there something that you would change, if you could go back, about your process of technical development?**

No. However, I wish that the system of classical tuition was more exploratory and it had a more open-minded approach. It is basically old fashioned and based mostly on playing old pieces.

### **3- What is your knowledge of the technical demands necessary for jazz guitar performance?**

I have some knowledge, however it is not too extensive. I did a jazz a second study at Cheethams School of Music. I played with the big band at RNCM. It is a radically different right hand technique. Chord reading would present a problem for classical players, as they are based on symbols which you don't utilize in the classical school. I also think that the transition is mostly mental rather than physical, given the improvisational aspects of jazz.

### **4- Overall, do you think that between jazz and classical guitar, there is one style that is technically more demanding?**

I consider this question philosophically difficult. Classical piece-learning can require more demand on a single piece, as you might spend sometimes around a year preparing one piece. I think they have different merits. Maybe they should be judged separately.

### **5- Do you think that there is enough communication between the jazz and classical schools of guitar playing?**



Almost no-one pursues the two styles equally. There is no real communication ideologically speaking. Ralph Towner is the only guitarist who I consider to be equally dedicated to the two. The two styles are fairly restricted.

**6- How much of your practice routine has been established by yourself and how much of it has been established by a tutor?**

I learned to practice at Cheethams School of Music. At that time my practice routine was fully set by a tutor. Progressively that practice has been set by me in more recent years, as far as the content. However, the knowledge of how to practice is still the same knowledge that I was taught at Cheethams.

**7- How important do you think it is for a classical guitarist to understand the compositional and harmonic techniques and components that exist in the music that they play?**

I think it is important and I don't think that too many people do it. There is usually a score-centric approach in classical music. The idea of understanding these techniques and components is generally undervalued and not done enough. I have seen it happen a lot in Baroque music for example, where many performers have no knowledge of harmony and counterpoint, etc.

**8- Do you think that it is possible for a guitarist to become fully advanced at both styles?**

I don't think it is possible to become equally advanced at both. However I do think it is possible to become very advanced at both. The thing is that you are likely to have always given one a little more time than the other at any given moment. With that in mind, there is no reason why that couldn't happen with a lot of time dedicated to it and careful practice. Even if you are not perfectly equally advanced at both.

**9- Do you think that the future will see a different relationship between the two schools of guitar?**

Yes. But I don't think it is easy to know how. I think jazz has moved much faster than classical in its repertoire, whereas classical has remained more static and

lives more in the past. This is reflected in the classical guitar community, which is more conservative. Classical is stretching more now however, with South American compositions adding to the mainstream repertoire.

But in general one can see the difference in evolution between the mainstream repertoires of these two genres if one thinks about how each has changed since the 50s.

**10-Do you think that there can be an amalgamation of the two schools of guitar?**

Yes. However, there are not enough teachers that can do it. Also, by the nature of what and how people want to learn, it might not be needed for many cases.

**11-What does your current practice routine involve?**

My most recent practice routine involved the preparation of a final recital for the RNCM Masters course in performance. It was a 50 min programme. There were some electric pieces, as well as some acoustic ones, in a completely solo performance.

A lot of what this repertoire required me to practice was different from the traditional technical demands of classical repertoire. For example, I had to practice fade-in volume controlling, left hand tapping, controlling sustain and feedback and overlapping duplets at pianissimo.

**12-Do you have a list of players which you think that everyone should listen to?**

Robert Brightmore, Paul Galbareth, Steve McKee, Magnus Anderson.

### Appendix 3

**An experiment on how one could approach a melodic improvisation over a classical piece (audio CD and lead sheet of Heitor Villa-Lobo's *Prelude N 1*).**

**CD, explanation and lead sheet (created by the author based on the original score)**

The purpose of my thesis and conclusions is not that of trying to get classical players to become advanced jazz players or vice versa. Instead, it is to show the possibilities each of these styles offers for further-development *within a guitarist's own idiom* by raising their awareness of new areas of understanding about the guitar as an instrument (not idiom-specific), which have been developed by each other to profound levels, and which are usually not mentioned within their own schools.

Nonetheless, as an experiment, I am including a recording in which I improvise over the classical piece *Prelude N 1* by Heitor Villa-Lobos (also performed on the DVD in its original form). The experience was both challenging and also revealing. In order to adapt the piece to a more jazz-influenced context, I recorded the harmony without the vital use of *rubato*, *ritardando*, *accelerando*, *crescendo* and *decrescendo* that are essential for classical performance, particularly in the romantic branch (that in which this piece was written). This, in my view, made the piece lose a huge amount of its musicality and vitality, and may also be seen to deviate a little too much from what some of the time signature changes suggest (particularly the 3/8 passage starting on bar 68). It was always known to me that jazz and classical were very different in this sense (as jazz, like much popular music, has usually a much more rigid use of tempo than classical). Nonetheless, I never imagined that the extraction of this element from a classical piece such as this could be so (in my opinion) devastating to its impact.

I enjoyed the experiment very much and certainly learnt from it. One of the things that became evident to me was that jazz composers are not only experts in manipulating harmony, but also in writing in such a way that they create a perfect platform over which musicians can improvise.

# PRELUDE N 1

HEITOR VILLA-LOBOS

5

9

13

17

21

25

29

33

37

41

Chords:  $E_m$ ,  $A_m$ ,  $G^7$ ,  $F\#^{11}$ ,  $B/F\#$ ,  $B^7$ ,  $B^7/A$ ,  $B^7/G$ ,  $B^7/F\#$ ,  $E_m$ ,  $A_m$ ,  $E_m$ ,  $G^o$ ,  $F\#^o$ ,  $A^o$ ,  $G\#^o$ ,  $B^o$ ,  $A\#^o$ ,  $C^o$ ,  $B^o$ ,  $D^o$ ,  $B^o$ ,  $G\#^o$ ,  $F^o$ ,  $D^o$ ,  $B^7$ ,  $B^7/A$ ,  $B^7/G$ ,  $B^7/F\#$ ,  $E_m$ ,  $D^o$ ,  $C\#^o$ ,  $C^o$ ,  $B^7$ ,  $E_m$ ,  $C^7$ ,  $B^7$ ,  $E_m$

45 **C7** **B7** **E<sub>m</sub>**

49 **C#<sup>o</sup>/E** **TO** **F/C** **B7**

53 **E** **B<sup>13</sup>SUS<sup>4</sup>** **E** **B<sup>13</sup>SUS<sup>4</sup>**

57 **E** **A** **E** **F<sub>m</sub>A<sup>7</sup>/A**

61 **E** **B<sup>13</sup>SUS<sup>4</sup>** **E** **B<sup>13</sup>SUS<sup>4</sup>**

65 **E** **B<sup>13</sup>SUS<sup>4</sup>** **E** **B<sup>13</sup>SUS<sup>4</sup>** **E** **B<sup>13</sup>SUS<sup>4</sup>** **E** **Am<sup>7</sup>**

69 **1.** **B**

73 **C** **B** **A** **G**

77 **F** **B<sup>7</sup>** **2.** **B<sup>7</sup>** **B<sup>7</sup>/A** **B<sup>7</sup>/G** **B<sup>7</sup>/F#** **D.S. AL CODA**

81 **C<sub>m</sub>A<sup>13</sup>#11/E** **E**

## Appendix 4

### List of players studied during research

#### Classical players

##### A

Gerard Abiton

Cesar Amaro

Magnus Andersson

Mauriel Anderson

Laurindo Almeida

Sergio Assad

Oadir Assad

##### B

David Bainbridge

Aquiles Bae

Leo Brouwer

Agustin Barrios

Julian Bream

Manuel Barrueco

Raul Borges

Srdjan Bulat

Robert Brightmore

Nora Buschmann

Dusan Bogdanovic

Liona Boyd

**C**

Abel Carlevaro

Jesus Castro Balbi

Olivia Chiang

Kim Chung

Norbert Craft

Andras Csaki

**D**

Nicolas de Souza Barros

Jose Rey de la Torre

Graham Devine

Alirio Diaz

Carlo Domeniconi

Zoran Dukic

Roland Dyens

Marcin Dylla

**E****F**

Eduardo Fernandez

Shin Ichi Fukuda

Eliot Fisk

**G**

Paul Galbraith

James Girling



Ricardo Giuffrida  
Cayo Sila Godoy  
Kevin Gallagher  
Michael Gratovich

## **H**

Nicola Hall  
Frederick Hand  
John Harper  
Alec Holcomb  
Adam Holzman  
Anika Hutschreuther

## **I**

Sharon Isbin

## **J**

## **K**

William Kanengiser  
Alberta Khoury  
Milos Karadagic  
Per-Olov Kindgren  
Irina Kulikova

## **L**

Anna Likhacheva

## **M**

David Martinez

Rovshan Memedkuliev

Johannes Moller

Anabel Montesinos

Filomena Moretti

## **N**

Russell Neville

Mikkel Egelund Nielsen

## **O**

Craig Ogden

David Oakes

## **P**

Christopher Parkening

Nicholas Petro

Alvaro Pierri

Sanja Plohl

## **Q**

Luis Quintero

## **R**

David Russell

Ruben Riera

Rodrigo Riera

Gary Ryan

Raphael Rabello

Tatyanna Ryzhkova

Pepe Romero  
Berta Rojas  
Ignacio Rodes  
Paola Requena

## **S**

George Sakellariou  
Regino Sainz de La Maza  
Eduardo Sainz de La Maza  
Andres Segovia  
Isabella Selder  
Emma Smith  
Raphaella Smits  
Laura Snowden  
Pavel Steidl

## **T**

Lianto Tjahjoputro  
Scott Tenant  
Ralph Towner

## **U**

## **V**

Benjamin Vardery  
Roman Viazovskiy  
Jason Vieaux  
Ana Vidovic  
Nataly Vakovskaya

**W**

John Williams

**X**

Xue Fei Yang

**Y**

Kazuhito Yamashita

Narciso Yepes

Andrew York

**Z**

Fabio Zanon

**Jazz players****A**

Laurindo Almeida

John Abercrombie

Tuck Andress

Chet Atkins

**B**

George Benson

Gene Bertoncini

Kenny Burrell

Chris Buono

Les Bolger

Ed Bickert

Charlie Byrd

Aquiles Baez

Teddy Bunn

Lenny Breau

Daniel Brew

## **C**

Charlie Christian

James Chirillo

Larry Coryell

Earl Clough

Carl Cress

## **D**

## **E**

Tommy Emmanuel

Erik Essix

John Etheridge

Juan Angel Esquivel

## **F**

Bill Frisell

Tal Farlow

Jody Fisher

Nir Felder

## **G**

Grant Green

Ted Greene

Freddie Green

Bob Gil

James Girling

Mick Goodrick

## **H**

Jim Hall

John Harper

Ken Hatfield

Scott Henderson

Andy Hulme

Anton Hunter

Charlie Hunter

Alan Holdsworth

**I**

**J**

Lonnie Johnson

Ronnie Jordan

**K**

Barney Kessel

John Knowles

**L**

Bireli Lagrene

Eddie Lang

Lionel Loueke

Romero Lubambo

**M**

Pat Martino

Pat Metheny

Stuart McCallum

John McLaughlin

Gonzalo Mico

Tim Miller

Ben Monder

Wes Montgomery

Howard Morgen

Oscar Moore

**N**

**O**

Trefor Owen

David Oakes

**P**

John Pizzarelli

Bucky Pizzarelli

Adam Palma

Joe Pass

Gary Potter

Baden Powell

**Q**

**R**

Jimmy Raney

Emily Remler

Adam Rafferti



Django Reinhardt

Lee Ritenour

## **S**

John Scofield

Johnny Smith

Mike Stern

## **T**

Martin Taylor

Ralph Towner

## **U**

## **V**

Kevin Van Sant

George Van Eps

Frank Vignola

## **W**

Mike Walker

Matthew Warnock

## **X**

## **Y**

## **Z**

Appendix 5

Scores and lead sheets performed on the DVD

A Mindinha

1

PRÉLUDE N° 1

Pour Guitare

H. VILLA - LOBOS

(Rio, 1940)

Andantino espressivo

*cresc. anim.*

*poco allarg.* *a tempo*

*rit.*

*a tempo*

*allarg.* *a tempo*

*rall.* *a tempo*

① ②

③ ④

Detailed description: This musical score is written for guitar on a single treble clef staff. It consists of ten staves of music. The first two staves feature a complex rhythmic pattern of eighth and sixteenth notes, with a dynamic marking of *cresc. anim.* (crescendo, animation). The third staff begins with a *poco allarg.* (slightly slower) instruction, followed by a return to *a tempo*. The fourth staff includes a *rit.* (ritardando) instruction. The fifth staff is marked *a tempo*. The sixth staff features a *allarg.* instruction and includes two circled chord diagrams labeled ① and ②. The seventh staff is marked *rall.* (rallentando), followed by a return to *a tempo*. The eighth staff includes two more circled chord diagrams labeled ③ and ④. The final two staves continue the rhythmic and harmonic progression.

7

*rit.* **Più mosso**

*rall.* **Poco meno**

*allarg. poco a poco*

The musical score consists of eight staves of music. The first staff begins with a treble clef, a key signature of one sharp (F#), and a 7-measure rest. It features a series of chords and arpeggiated figures. The second staff is marked *rit.* and **Più mosso**, showing a change in tempo and dynamics. The third and fourth staves continue the melodic and harmonic development. The fifth and sixth staves show further rhythmic and melodic patterns. The seventh staff is marked *rall.* and **Poco meno**, indicating a deceleration. The eighth and final staff is marked *allarg. poco a poco*, showing a gradual slowing down of the music.

*a tempo*      *rall.*      **1º Tempo**

*rit.*

*p.*      *p.*      *p.*      *p.*      *p.*      *p.*      *p.*      *p.*

*cresc.*

*anim.*      *poco*

Musical score for a piece in 3/4 time, featuring various dynamics and tempo markings. The score consists of seven staves of music. The first staff begins with a treble clef, a key signature of three sharps (F#, C#, G#), and a 3/4 time signature. It includes markings for *a tempo*, *rall.*, and **1º Tempo**. The second staff has a *rit.* marking. The third staff has a *p.* marking. The fourth staff has a *p.* marking. The fifth staff has a *p.* marking. The sixth staff has a *p.* marking and a *cresc.* marking. The seventh staff has *anim.* and *poco* markings. The music features a variety of rhythmic patterns, including eighth and sixteenth notes, and rests.

*allarg.* *a tempo* *a tempo* *rall.* *a tempo* *rall.*

The musical score consists of eight staves of music. The first staff begins with an *allarg.* marking and transitions to *a tempo*. The second and third staves continue the *a tempo* section. The fourth staff introduces a *rall.* section, which then returns to *a tempo* in the fifth staff. The sixth and seventh staves continue the *a tempo* section, and the eighth staff concludes with a *rall.* section.

# Vals Venezolano No. 3

Antonio Lauro  
Revisado por Alirio Diaz

**Allegro ritmico**

The musical score is written for guitar in 3/4 time, key of D major. It begins with a dynamic marking of *mf*. The first staff includes fingering numbers (1, 2, 3, 4) and a circled 3. The second staff features a circled 3 and a circled 5, along with fret numbers VII, V, VI, and VII. The third staff has a circled 3 and a circled 5, and includes the instruction "Arm. 12". The fourth staff contains a circled 3 and a circled 5. The fifth staff includes a circled 3 and a circled 5, and features fret numbers VII, V, and II. The sixth staff has a circled 3 and a circled 5, and includes fret numbers III and II. The seventh staff includes a circled 3 and a circled 5, and features fret numbers VII and X. The eighth staff contains a circled 3 and a circled 5. The score is composed of eight staves of music, each with a treble clef and a key signature of one sharp (F#).

This page of musical notation is for guitar, written in a key with three sharps (F#, C#, G#). It consists of seven staves of music. The notation includes various chords, melodic lines, and technical markings such as fingering numbers (0-4), slurs, and dynamic markings (p, mf). Roman numerals (II, IV, VII, IX) indicate chord positions. The page ends with a double bar line and a final chord.



(BALLAD) **DREAMSVILLE** - HENRY MANCINI/  
JAY LIVINGSTON/ RAY EVANS

Handwritten musical score for "Dreamsville" in G major, 4/4 time. The score consists of a melody line and a bass line with chords. The key signature has one sharp (F#).

**Melody Line:**

- Measure 1: Cmaj7
- Measure 2: G7/C
- Measure 3: Cmaj7
- Measure 4: E-7
- Measure 5: A7
- Measure 6: D-7
- Measure 7: G7
- Measure 8: D-7
- Measure 9: Db7(#11)
- Measure 10: Cmaj7
- Measure 11: F#-7b5
- Measure 12: B7#5
- Measure 13: E-7
- Measure 14: A7
- Measure 15: F#-7
- Measure 16: B-7
- Measure 17: C-7
- Measure 18: F7
- Measure 19: G#-7b5
- Measure 20: C#7b9
- Measure 21: F#-7b5
- Measure 22: B7b9
- Measure 23: E-7b5
- Measure 24: A7b9
- Measure 25: D-7
- Measure 26: G7
- Measure 27: Cmaj7
- Measure 28: G7/C
- Measure 29: Cmaj7
- Measure 30: G-7
- Measure 31: F#7
- Measure 32: C-7/F
- Measure 33: F7
- Measure 34: D-7
- Measure 35: Eb-7
- Measure 36: D-7
- Measure 37: Db7(#11)
- Measure 38: Cmaj7

**Bass Line:**

- Measure 1: Cmaj7
- Measure 2: G7/C
- Measure 3: Cmaj7
- Measure 4: G-7
- Measure 5: F#7
- Measure 6: C-7/F
- Measure 7: F7
- Measure 8: D-7
- Measure 9: Eb-7
- Measure 10: E-7
- Measure 11: A7
- Measure 12: D-7
- Measure 13: G7
- Measure 14: D-7
- Measure 15: Db7(#11)
- Measure 16: Cmaj7
- Measure 17: F#-7b5
- Measure 18: B7#5
- Measure 19: E-7
- Measure 20: A7
- Measure 21: F#-7
- Measure 22: B-7
- Measure 23: C-7
- Measure 24: F7
- Measure 25: G#-7b5
- Measure 26: C#7b9
- Measure 27: F#-7b5
- Measure 28: B7b9
- Measure 29: E-7b5
- Measure 30: A7b9
- Measure 31: D-7
- Measure 32: G7
- Measure 33: Cmaj7
- Measure 34: G7/C
- Measure 35: Cmaj7
- Measure 36: G-7
- Measure 37: F#7
- Measure 38: C-7/F
- Measure 39: F7
- Measure 40: D-7
- Measure 41: Eb-7
- Measure 42: D-7
- Measure 43: Db7(#11)
- Measure 44: Cmaj7

Copyright © 1959 ST. ANGELO MUSIC, JAY LIVINGSTON MUSIC and NORTHRIDGE MUSIC COMPANY  
Copyright Renewed  
All Rights for ST. ANGELO MUSIC Controlled and Administered by UNIVERSAL MUSIC CORP.

168

(MED.)

# HERE'S THAT RAINY DAY

-JIMMY VAN HEUSEN/JOHNNY BURKE

*Gmaj7 Bb7 Ebmaj7 Abmaj7*

*A-7 D7 Gmaj7 D-7 G7*

*1<sup>st</sup> C-7 F7 Bbmaj7 Ebmaj7*

*A-7 D7 Gmaj7 A-7 D7*

*2<sup>nd</sup> Cmaj7 A-7 D7 B-7 E-7 A7*

*A-7 D7 G6 (A-7 D7)*

274

(BRIGHT JAZZ)

# MR. P.C.

-JOHN COLTRANE

C-

F- C-

Ab7 G7 C-

## Reference list

- Achard, K. (1991). *The history and development of the american guitar*. Westport: Bold Strummer.
- Aguado, D (1966). *Complete method for guitar*. Buenos Aires: Ricordi.
- Alexander, C (1999). *Masters of jazz guitar*. London: Balafon.
- Baker, M. (2004). *Mickey Baker's complete course in jazz guitar – Book 2*. Blaydon on Tyne: Ashley.
- Bream, J. (2013, 28 December). *Julian Bream Masterclass 1978: Heitor Villa Lobos 3 preludes*. [Multimedia] Retrieved from <https://www.youtube.com/watch?v=iAXUzlrukt0>
- Bream, J (1963) *Improvisation with Ali Akbar Khan on sarod* [Multimedia] Retrieved from: <https://www.youtube.com/watch?v=jxticeCMmPA>
- Carlevaro, A. (2013, 9 February) *A guitar lesson with Abel Carlevaro*. [Webcast]. Retrieved from <https://www.youtube.com/watch?v=-XbUkcjuMds>
- Carulli, F (1955). *Complete method for guitar*. Buenos Aires: Ricordi.
- Christiansen, M. (2016). *Complete jazz guitar method*. Pacific: Mel Bay
- Conde, J. A. (1900). *History of the Arabs in Spain*. London: Wilson and Ogilvy.
- Coryell, L. (Director). (2005). *Larry Coryell's jazz guitar volumes 1, 2 and 3*. [DVD]. Sparta: Stephan Grossman's Guitar Workshop.
- De la Maza (2012, 16 December) *Regino Sainz de la Maza, entrevista* [Webcast]. Retrieved from <https://www.youtube.com/watch?v=MXcylKtDXYo>
- De Jong, C (2016) *Two Free Improvisations*. [Multimedia]. Retrieved from: <https://www.youtube.com/watch?v=-HltxKrnV4>
- Duncan, C (1983). *A modern approach to classical guitar (book three)*. Milwaukee: Hal Leonard.
- Evans T & M. (1977) *Guitars: from renaissance to rock*. Paddington Press.
- Fernandez, E. (2001). *Technique, mechanism, learning: an investigation into becoming a guitarist*. Clumbus: Guitar Heritage.

- Fisher, J (1995). *Jazz guitar – intermediate*. Van Nuys: Alfred.
- Gioia, T. (2011). *The history of jazz*. New York: Oxford.
- Glise, A (1997). *Classical guitar pedagogy: a handbook for teachers*. St Joseph: Aevia
- Goodrick, M. (1987). *The advancing guitarist: applying guitar concepts and techniques*. Bury Saint Edmunds: Music Sales.
- Green, A (2000). *Jazz guitar technique: breaking the skill barrier*. Brooklyn: Microphonic.
- Greene, T (1985). *Modern chord progressions: jazz and classical voicings for guitar*. Van Nuys: Alfred
- Gruhn, G & Carter, W. (2012). *Acoustic guitars and other fretted instruments*. San Francisco: Miller Freeman.
- Gunod, N (1996). *Classical guitar for beginners*. Van Nuys: Alfred
- Hahn, J. (2003). *Complete Jazz Guitar Method*. Pacific: Mel Bay
- Hand, F. (2004). *Classical guitar technique and musicianship*. Homespun
- Inzaola, R (2013). *Summa kitharologica, volume 1: the physiology of guitar playing: functional anatomy and biomechanics*. Pacific: Mel Bay.
- Inzaola, R (2000). *On practicing: a manual for students of guitar performance*. Pacific: Mel Bay.
- Isbin (2012, 18 May). *Sharon Isbin Interview and lesson on guitar TV*. [Multimedia] Retrieved from <https://www.youtube.com/watch?v=v-iCOoYB84w>
- Kennedy, M & Kennedy, J (2006). *Oxford concise dictionary of music* (5<sup>th</sup> ed.). Oxford: Oxford University Press.
- Kernfeld, B (2006). *The Story of Fake Books*. Maryland: Scarecrow
- Lee, R. (1993). *Ronny Lee – Jazz Guitar Method*. Fenton: Mel Bay
- Lincoln Collier, J (1978). *The making of jazz*. London: Papermac
- Martino, P (1989). *Linear expressions*. London: Omnibus
- Martino, P (2011, 12 April). *Pat Martino: creative force*. [Multimedia] Retrieved from <https://www.youtube.com/watch?v=OSCSvJpB6GI&list=PL27DE7E3A7EC0796F>
- Martino, P (2011, 16 June). *Pat Martino: quantum guitar*. [Multimedia] Retrieved from <https://www.youtube.com/watch?v=u5oeiRz902k&list=PL3E26681FB7263E75>

- Masters, M (2010). *Reaching the next level: a method for experienced classical guitarists*. Pacific: Mel Bay.
- Nail, R. J. (1975). *Jazz guitar (with classical technique)*. Boston: Boston Music Company.
- Nichols, D. (1998). *The Cambridge history of American music*. Cambridge: Cambridge University Press
- Oakes, D (2000). *Classical and fingerstyle guitar techniques*. Milwaukee: Hal Leonard.
- Parkening, C. (1972) *The Christopher Parkening Guitar Method*. Milwaukee: Hal Leonard
- Pass, J. (2004). *An evening with Joe Pass*. [DVD] Miami: Warner Bros
- Pass, J. (2004). *Jazz Lines*, [DVD] Miami: Warner Bros
- Pujol, E. (1991). *Guitar school: a theoretical-practical method for the guitar based on the principles of Francisco Tarrega, Book 3*. Columbus: Editions Orphee.
- Rodriguez Arenas, M. (1987). *The school of the guitar*. Buenos Aires: Ricordi
- Rodrigues Jr, W (2011) *When the classical guitar meets the looper*. [Multimedia]  
Retrieved from: <https://www.youtube.com/watch?v=Ov7Vh3OXhYo>
- Roman, M (1991) Man at his best: Clef Notes. *Esquire*. Vol. 113.
- Segovia, A (2011, 17 April). *Andres Segovia documentary from 1972*. [Multimedia].  
Retrieved from <https://www.youtube.com/watch?v=tccQoHEDEuc>
- Sadie, S (1984). *The new Grove dictionary of musical instruments*. New York: Macmillan.
- Schroedl, J. (2004). History of the real book. Retrieved 13 October, 2016, from <https://officialrealbook.com/history/>
- Scofield, J. (2004). *John Scofield – jazz-funk guitar*. [DVD]. Van Nuys: Alfred
- Spring, M. (2001) *The lute in Britain: a history of the instrument and its music*. New York: Oxford University Press.
- Stearns, M. W. (1958). *The Story of Jazz*. New York: Oxford University Press.
- Stern, M. (2001). *Mike Stern – instructional DVD*. [DVD] Milwaukee: Hal Leonard
- Tenant, S (2006). *Pumping nylon: the classical guitarist's technique handbook*. Van Nuys: Alfred.

- Tenant, S. (2003). *Basic classical guitar method*. Van Nuys: Alfred
- Turnbull, H. (1991). *The guitar: from the renaissance to the present day*. Westport: The Bold Strummer.
- Vardanyan, G (2013). *Complete warm-up for classical guitar*. Pacific: Mel Bay.
- Wise, L. (2001). *Jazz improvisation for guitar*. Milwaukee: Hal Leonard
- Wyble, J. (2001). *The art of two-line improvisation*. Pacific: Mel Bay.
- Wyble, J. (2001). *Concepts for the classical and jazz guitar*. Pacific: Mel Bay.
- Yentob, A. (2016, 10 February). *The story of the guitar: part 1*. [Multimedia] Retrieved from <https://www.youtube.com/watch?v=bGHkcl3mn4w>

*All quotes in the Interview-based Research chapter are taken from the interviews I conducted personally with guitarists as part of this research. They can all be seen/heard in Appendices 3 and 4.*

## Bibliography

- Abersold, J (1967). *How to play jazz and improvise- volume 1*. New Albany: Jamey Abersold Jazz.
- Achard, K. (1991). *The history and development of the american guitar*. Westport: Bold Strummer.
- Aguado, D (1966). *Complete method for guitar*. Buenos Aires: Ricordi.
- Ake, D. A. (2002). *Jazz cultures*. Berkeley: University of California Press.
- Alexander, C (1999). *Masters of jazz guitar*. London: Balafon.
- Alexander, C (1996). *Classic Guitars of the 50s*. Hong Kong: Balafon.
- Andrews Green, S. (1999). *Grant Green- Rediscovering the forgotten genius of jazz guitar*. San Francisco: Miller Freeman.
- Artzt, A. (1993). *The art of practicing (guitar)*. Westport: Bold Strummer.
- Baez, G. (Director) (2006). *Aquiles Baez: el saman*. [DVD]. Caracas: AMG.
- Bagley, A. (Producer). (2016, 10 February). *The story of the guitar: part 1*.  
[Multimedia] Retrieved from <https://www.youtube.com/watch?v=bGHkcl3mn4w>
- Bagley, A. (Producer). (2016, 10 February). *The story of the guitar: part 2*.  
[Multimedia] Retrieved from <https://www.youtube.com/watch?v=h5Qm67JuOeQ>
- Bagley, A. (Producer). (2016, 10 February). *The story of the guitar: part 3*.  
[Multimedia] Retrieved from <https://www.youtube.com/watch?v=snCoCUzVGfI>
- Baker, M. (2004). *Mickey Baker's complete course in jazz guitar – book 1*. Blyden on Tyne: Ashley.
- Baker, M. (2004). *Mickey Baker's complete course in jazz guitar – Book 2*. Blyden on Tyne: Ashley.
- Bennett, A and Dawe, K. (2001). *Guitar cultures*. Oxford: Berg.
- Benson, G (2007) *Benson on martino*. [Multimedia] retrieved from:  
<https://www.youtube.com/watch?v=Jb8tgXi-hF4>
- Berg, A (2006). *Mastering guitar technique: process and essence*. Pacific: Mel Bay.
- Bertoncini, G (1991). *Approaching the guitar*. San Diego: Neil a Kjos Music
- Boling, M. (2004). *Creative comping concepts for jazz guitar*. Pacific: Mel bay.



- Booth, E. (2009). *The music teaching artist's bible – becoming a virtuoso educator*. Oxford: Oxford University Press.
- Bream, J (1963) *Improvisation with Ali Akbar Khan on sarod* [Multimedia] Retrieved from: <https://www.youtube.com/watch?v=jxticeCMmPA>
- Breton, J. D. (Producer). (2013, 5 September). *John Abercrombie: concepts for jazz guitar improvisation*. [Webcast]. Retrieved from <https://www.youtube.com/watch?v=ZfkKACFNIIE>
- Brouwer, L. and Paolini, P. (2008). *Scales for guitar: a study method*. London: Ricordi.
- Buono, C. (2006). *Jazz lead guitar solos*. Van Nuys: Alfred
- Burnard, P and Murphy, R (2013) *Teaching music creatively*. Oxon: Routledge.
- Byzantine, J (1984). *Albeniz, six pieces from 'Suite Espagnol'*. London: Schott.
- Can I afford it? (2015, October). *Downbeat Magazine*. Retrieved from: [http://downbeat.com/digitaledition/2015/spcseg/\\_art/SMG1510.pdf](http://downbeat.com/digitaledition/2015/spcseg/_art/SMG1510.pdf)
- Capone, P. (2007). *Exploring jazz guitar*. London: Schott.
- Carcassi, M. (1836). *Method for the Guitar*. London: Schott
- Carr, I., Fairweather, D. & Priestley, B, Alexander, C. (2004). *A rough guide to jazz*. London: Rough Guides.
- Carter, W. (1995). *The Martin book -a complete history of Martin guitars*. London: Balafon.
- Carulli, F (1955). *Complete method for guitar*. Buenos Aires: Ricordi.
- Casanova, R. (2014) *El Cuatro en TV – Rafael Casanova Duarte*. [Multimedia] Retrieved from: <https://www.youtube.com/watch?v=zNc6H8zq3WA>
- Charron, A. J. (2014) *A brief history of the guitar*. Article. Retrieved from: <http://www.guitarnoise.com/lessons/brief-history-of-the-guitar/>
- Chilton, J (2004). *Who's who of British jazz*. London: Continuum
- Christiansen, C (2005). *Guitar journals: jazz*. Pacific: Mel Bay.
- Christiansen, C (2002). *Jazz guitar standards: a comprehensive approach to playing tunes*. Pacific: Mel bay.
- Coelho, V. A. (2003). *The Cambridge companion to: the guitar*. Cambridge: Cambridge University Press.

- Conde, J. A. (1900). *History of the Arabs in Spain*. London: Wilson and Ogilvy.
- Coryell, L. (Director). (2005). *Larry Coryell's jazz guitar volume 1*. [DVD]. Sparta: Stephan Grossman's Guitar Workshop.
- Coryell, L. (Director). (2005). *Larry Coryell's jazz guitar volume 2*. [DVD]. Sparta: Stephan Grossman's Guitar Workshop.
- Coryell, L. (Director). (2005). *Larry Coryell's jazz guitar volume 3*. [DVD]. Sparta: Stephan Grossman's Guitar Workshop.
- Crawford, J. A., (2002). *Jazz guitar: the history, the players*. University of Tennessee Honors Thesis Projects. Retrieved from:  
[http://trace.tennessee.edu/utk\\_chanhonoproj/528](http://trace.tennessee.edu/utk_chanhonoproj/528)
- Christiansen, M. (2016). *Complete jazz guitar method*. Pacific: Mel Bay
- Cummings, R. (2017) A biography of Miguel Llobet. *All Music*. Retrieved from:  
<http://www.allmusic.com/artist/miguel-llobet-mn0001518691/biography>
- Dawe, K. (2010). *The new guitarscape in critical theory, cultural practice and musical performance*. Farham: Ashgate.
- De Jong, C (2016) *Two Free Improvisations*. [Multimedia]. Retrieved from:  
<https://www.youtube.com/watch?v=-HltxKrnV4>
- Diaz, A (2012, 7 February), *Producciones Orozco-Encuenrto con Alirio Diaz* [Multimedia]. Retrieved from [https://www.youtube.com/watch?v=JRZ80JLt\\_4M](https://www.youtube.com/watch?v=JRZ80JLt_4M)
- Duncan, C (1985). *A modern approach to classical guitar repertoire (part two)*. Milwaukee: Hal Leonard.
- Duncan, C (1983). *A modern approach to classical guitar (book three)*. Milwaukee: Hal Leonard.
- Duncan (1980). *The art of classical guitar playing*. Miami: Warner Bros.
- Dziuba, M. (2003). *The big book of jazz improvisation*. Van Nuys: Alfred.
- Eberhardt, A. (Director). (2004). *John Scofield jazz-funk lines*. [DVD]. Van Nuys: Alfred.
- Erlewine, D (2001). *How to make your electric guitar play great*. San Francisco: Backbeat.

- Evans T & M. (1977) *Guitars: from renaissance to rock*. Paddington Press.
- Ferguson, J. (2014). *Comping standards for jazz guitar*. Pacific: Mel Bay.
- Fernandez, E. (2001). *Technique, mechanism, learning: an investigation into becoming a guitarist*. Clumbus: Guitar Heritage.
- Fewell, G. (2005). *Jazz improvisation for guitar: a melodic approach*. Boston: Berklee
- Fisher, J (1995). *Jazz guitar – beginning*. Van Nuys: Alfred.
- Fisher, J (1995). *Jazz guitar – intermediate*. Van Nuys: Alfred.
- Fisher, J (1995). *Jazz guitar – mastering*. Van Nuys: Alfred.
- Franco, E. (1980). Emilio Pujol, last disciple of Tarrega, was a key figure of Spanish music. *El Pais*. Retrieved from:  
[http://elpais.com/diario/1980/11/19/cultura/343436415\\_850215.html](http://elpais.com/diario/1980/11/19/cultura/343436415_850215.html)
- Fripp, R. (n.d.). *Robert Fripp – Frippertronics Interview*. [Multimedia] Retrieved from:  
[https://www.youtube.com/watch?v=kJ0\\_IID7c14](https://www.youtube.com/watch?v=kJ0_IID7c14)
- Frisell, B. (2010). *Bill Frisell in conversation with curator Philip Bither*. [Multimedia] Retrieved from: <https://www.youtube.com/watch?v=nvW6H4iPeeo>
- Frisell, B. (2009). *Bill Frisell interview – part 2*. [Multimedia] Retrieved from:  
<https://www.youtube.com/watch?v=YdJqDa0i3NA>
- Gambale, F. (2014) *Frank Gambale – Interview* [Multimedia] Retrieved from:  
<https://www.youtube.com/watch?v=vl-Ci-EZUn0>
- Gavin, B. (Director) (2004). *Mark Anthony Turnage: getting scorched*. [DVD]. RM Associates/BBC/Hessischer Rundfunk.
- Gelling, P. (2008). *Jazz guitar manual*. Emeryville: Koala.
- Gelly, D & Fogg, R. (2005). *Django Reinhardt: know the man, play the music*. Milwaukee: Backbeat.
- Gilovic (Producer) (2014, 30 May). *Barney Kessel guitar lesson*. [Webcast]. Retrieved from <https://www.youtube.com/watch?v=fnoXbqadcjU>
- Gioia, T. (2011). *The history of jazz*. New York: Oxford.
- Glise, A (1997). *Classical guitar pedagogy: a handbook for teachers*. St Joseph: Aevia
- Gonzales, H. J. (Producer) (2012, 11 December). *Julian Bream: my life in music*. [Multimedia]. Retrieved from <https://www.youtube.com/watch?v=nJEtPqjh6vM>

- Goodrick, M. (1987). *The advancing guitarist: applying guitar concepts and techniques*. Bury Saint Edmunds: Music Sales.
- Goodrick, M & Miller, T (2012). *Creative chordal harmony for guitar: using generic modality compression*. Milwaukee: Hal Leonard
- Goodrick, M (2007). *Mr Goodchords almanac of guitar voice leading for the year 2001 and beyond: volume II*. Liquid Harmony Publishing.
- Govan, G (2015, 23 April). *Guthrie Govan: Alternate picking guitar lesson*. [Multimedia]; Retrieved from <https://www.youtube.com/watch?v=51OMFYGG-fs>
- Green, A (2000). *Jazz guitar technique: breaking the skill barrier*. Brooklyn: Microphonic.
- Green, A (2005). *Jazz guitar comping: raising your chord awareness*. Brooklyn: Microphonic.
- Green, L (2016) *How popular musicians learn – a way ahead for music*. New York: Ashgate
- Green, A (2002). *Jazz guitar structures: boosting your solo power*. Brooklyn: Monophonic.
- Greene, T. (2009). *Chord chemistry*. Van Nuys: Alfred.
- Greene, T (1985). *Modern chord progressions: jazz and classical voicings for guitar*. Van Nuys: Alfred
- Greene, T (1985). *Jazz guitar: single note soloing volume 1*. Van Nuys: Alfred
- Greene, T (2009). *Jazz guitar: single note soloing volume 2*. Van Nuys: Alfred
- Gregory, H. (1994). *1000 great guitarists*. London: Balafon Books.
- Gruhn, G & Carter, W. (1994). *Electric guitars and basses*. San Francisco: Miller Freeman.
- Gruhn, G & Carter, W. (2012). *Acoustic guitars and other fretted instruments*. San Francisco: Miller Freeman.
- Gunod, N (1996). *Classical guitar for beginners*. Van Nuys: Alfred
- Gunod, N. (2014). *Teach yourself to play classical guitar*. London: Alfred
- Hahn, J. (2003). *Complete Jazz Guitar Method*. Pacific: Mel Bay
- Hand, F. (2004). *Classical guitar technique and musicianship*. Homespun

- Harris, C. (2017) Alirio Diaz artist biography. *All Music*. Retrieved from:  
<http://www.allmusic.com/artist/alirio-diaz-mn0000088500/biography>
- Hart, B (1999). *Solo jazz guitar*. Milwaukee: Hal Leonard
- Haverstick, N. (2015). *The oud – Ancient to Modern*. Vintage Guitar Magazine.  
 Retrieved from: <http://www.unfretted.com/wp-content/uploads/2015/10/The-Oud-Ancient-to-Modern-by-Neil-Haverstick.pdf>
- Henry, P. (2010). *Classical guitar*. Milwaukee: Hal Leonard.
- Hughes, R. (2014) *Interview with Rober Fripp*. The Telegraph. Extracted from:  
<http://www.telegraph.co.uk/culture/music/rockandpop/features/11196079/Robert-Fripp-interview-Im-a-very-difficult-person-to-work-with.html>
- Hugorowski. (Producer). (2013, 9 February) *A guitar lesson with Abel Carlevaro*.  
 [Webcast]. Retrieved from <https://www.youtube.com/watch?v=-XbUkcjuMds>
- Hutchinson, R. (Director). (2004). *An evening with Joe Pass*. [DVD]. Miami: Warner Bros.
- Hutchinson, R. (Director). (2004) *Joe Pass: jazz lines*. [DVD]. Miami: Warner Bros.
- Huynh, T. (Produced) (2012, 5 Jan). *The Segovia master class in Spain*. [Multimedia]  
 Retrieved from <https://www.youtube.com/watch?v=XZDA1crTi9A>
- Inzaola, R (2009). *Kitharologus: the path to virtuosity*. Chanterelle.
- Inzaola, R (2000). *On practicing: a manual for students of guitar performance*.  
 Pacific: Mel Bay.
- Inzaola, R (2013). *Summa kitharologica, volume 1: the physiology of guitar playing: functional anatomy and biomechanics*. Pacific: Mel Bay.
- Irons, A., and Exely (Ed). (2008). *Enhancing learning through formative assessment and feedback*. Oxon: Routledge.
- Isbin (2012, 18 May). *Sharon Isbin Interview and lesson on guitar TV*. [Multimedia]  
 Retrieved from <https://www.youtube.com/watch?v=v-iCOoYB84w>
- Jeffries, S. (2013) Julian Bream: I am a better musician now than when I was 70. *The Guardian*. Retrieved from: <https://www.theguardian.com/music/2013/sep/13/julian-bream-better-musician-70>
- Jones, A. (1999). *Fast forward jazz guitar improvisation*. London: Music Sales
- Jones, A. & Dick, A (1995). *1001 guitar tips and tricks*. London: Wise.

- Kennedy, M & Kennedy, J (2006). *Oxford concise dictionary of music* (5<sup>th</sup> ed.). Oxford: Oxford University Press.
- Kernfeld, B (2006). *The Story of Fake Books*. Maryland: Scarecrow
- Lauro, A. (1963). *Quatro vales venezolanos for guitar*. Amsterdam: Broekmans and Van Poppel.
- Le, Q. (Producer) (2014, 12 october). *Andres Segovia: the song of the guitar*. [Multimedia]. Retrieved from <https://www.youtube.com/watch?v=S9AhUxIGagE>
- Lee, R. (1993). *Ronny Lee – Jazz Guitar Method*. Fenton: Mel Bay
- Lemos, R. (2009). *Jazz guitar soloing concepts*. Milwaukee: Hal Leonard.
- Leono, R (1998). *Joe Pass virtuoso standards: songbook collection*. Mel Bay.
- Levine, M. (1995). *The jazz theory book*. Petaluma: Sher Music.
- Lincoln Collier, J (1978). *The making of jazz*. London: Papermac
- Magli, D. (Producer) (2011, 17 April). *Andres Segovia documentary*. [Multimedia]. Retrieved from <https://www.youtube.com/watch?v=tccQoHEDEuc>
- Marshall, W. (2001). *Best of Wes Montgomery*. Milwaukee: Hal Leonard.
- Martino, P (1989). *Linear expressions*. London: Omnibus
- Martino, P (Producer) (2011, 12 April). *Pat Martino: creative force*. [Multimedia] Retrieved from <https://www.youtube.com/watch?v=OSCSvJpB6GI&list=PL27DE7E3A7EC0796F>
- Martino, P (Producer) (2011, 16 June). *Pat Martino: quantum guitar*. [Multimedia] Retrieved from <https://www.youtube.com/watch?v=u5oeiRz902k&list=PL3E26681FB7263E75>
- Masters, M. (2012). *The total classical guitarist*. Van Nuys: Alfred.
- Masters, M (2010). *Reaching the next level: a method for experienced classical guitarists*. Pacific: Mel Bay.
- Matsumoto, C. (Director). (2001). *Mike Stern: guitar instructional DVD* [DVD]. Milwaukee: Hal Leonard.
- Menn, D. (1992). *Secrets from the masters*. San Francisco: Backbeat Books.
- Metheny, P. (1997). *Pat Metheny interview – 1997*. [Multimedia] Retrieved from: <https://www.youtube.com/watch?v=0LdrM6NvQMc>

- Metheny, P. (2013). *Pat Metheny – lesson on improvisation*. [Multimedia] Retrieved from: <https://www.youtube.com/watch?v=UAc1CytLStw>
- Morgen, H (1999). *Solo guitar: insights, arranging techniques and classic jazz standards*. Miami: Warner Bros.
- Morris, S (2012). *The truth about jazz guitar (from one veteran player's perspective, anyway)*. Skip Morris.
- Morris, S (2013, 14 Oct). *Video Lesson: Scott Morris- Tone Production*. [Multimedia] retrieved from: <https://www.youtube.com/watch?v=T9xQLk61Pvg>
- Nadal, D (1994). *Guitar classics*. Mineola: Dover.
- Nail, R. J. (1975). *Jazz guitar (with classical technique)*. Boston: Boston Music Company.
- Nichols, D. (1998). *The Cambridge history of American music*. Cambridge: Cambridge University Press
- Noad, Frederick, M. (2008). *Solo guitar playing book 1: a complete course of instruction in the techniques of guitar performance*. AMSCO Music.
- Noad, Ffrederick, M. (1997) *Solo guitar playing: classical guitar*. AMSCO Music.
- Oakes, D (2000). *Classical and fingerstyle guitar techniques*. Milwaukee: Hal Leonard.
- Paez Arellano, R. (Producer). (2012, 16 December) *Regino Sainz de la Maza, entrevista* [Webcast]. Retrieved from <https://www.youtube.com/watch?v=MXcylKtDXYo>
- Parkening, C. (1972) *The Christopher Parkening Guitar Method*. Milwaukee: Hal Leonard
- Pass, J. (2004). *An evening with Joe Pass*. [DVD] Miami: Warner Bros
- Pass, J. (2004). *Jazz Lines*, [DVD] Miami: Warner Bros
- Pass, J. & Thrasher, B. (1996) *Joe Pass guitar style*. Van Nuys: Alfred.
- Pass, J (2015). *Joe Pass omnibook: for C instruments*. Milwaukee: Hal Leonard.
- Pujol, E. (1991). *Guitar school: a theoretical-practical method for the guitar based on the principles of Francisco Tarrega, Book 3*. Columbus: Editions Orphee.
- Quine, H (1990). *Guitar technique intermediate to advanced*. Oxford: Oxford University Press.

- Ranieri, S. (1965). *Method for guitar: book 1*. London: Cranz
- RareGuitar (Producer). (2013, 28 December). *Julian Bream Masterclass 1978: Heitor Villa Lobos 3 preludes*. [Multimedia] Retrieved from <https://www.youtube.com/watch?v=iAXUzIrukt0>
- Reeves, S (2007). *Creative jazz improvisation*. Upper Saddle River: Pearson Education.
- Ritchie, L (2011) *Innovative pedagogic series: creating a curriculum – embracing open learning in music*. Retrieved from: [https://www.heacademy.ac.uk/system/files/laura\\_ritchie\\_final.pdf](https://www.heacademy.ac.uk/system/files/laura_ritchie_final.pdf)
- Ritenour, L. (2010) *Lee Ritenour –LP – from six string theory* [Multimedia] Retrieved from: [https://www.youtube.com/watch?v=-ahnFeZ\\_inQ](https://www.youtube.com/watch?v=-ahnFeZ_inQ)
- Ritenour, L. (2013) *Interview with Lee Ritenour* [Multimedia] Retrieved from: [https://www.youtube.com/watch?v=3qPBsBh9\\_U8](https://www.youtube.com/watch?v=3qPBsBh9_U8)
- Rodriguez Arenas, M. (1987). *The school of the guitar*. Buenos Aires: Ricordi
- Rodrigues Jr, W (2011) *When the classical guitar meets the looper*. [Multimedia] Retrieved from: <https://www.youtube.com/watch?v=Ov7Vh3OXhYo>
- Roman, M (1991) Man at his best: Clef Notes. *Esquire*. Vol. 113.
- Romero, P (2012). *La guitarra: a comprehensive study of classical guitar technique and guide to performing*. King of Prussia: Theodore.
- Russell, D (2013, 9 March). *David Russell clase magistral*. [Multimedia]. Retrieved from <https://www.youtube.com/watch?v=zeCHYOTRQno>
- Sadie, S (1984). *The new Grove dictionary of musical instruments*. New York: Macmillan.
- Sagreras, J. (1973). *First guitar lessons*. Buenos Aires: Musical Iberoamericana.
- Segovia, A (1977). *Segovia – an autobiography of the years 1893-1920*. London: Boyars
- Schroedl, J. (2005). *Jazz guitar: a comprehensive guide*. London: Hal Leonard Europe.
- Schroedl, J. (2004). History of the real book. Retrieved 13 October, 2016, from <https://officialrealbook.com/history/>



- Scotfield, J. (2013). *John Scotfield interview with poolguitarblog*. Retrieved from:  
<https://www.youtube.com/watch?v=j-KpxtleM5w>
- Scotfield, J. (2004). *John Scotfield – jazz-funk guitar*. [DVD]. Van Nuys: Alfred
- Shearer, A. (2009). *Classic guitar technique*. Van Nuys: Alfred Music.
- Sideman, M & Del Nero, P. (2006). *Playing the changes: a linear approach to improvising*. Milwaukee: Hal Leonard
- Sokolow, F. (2002). *How to improvise with jazz chords*. Milwaukee: Hal Leonard.
- Spring, M. (2001) *The lute in Britain: a history of the instrument and its music*. New York: Oxford University Press.
- Staines, J., Clark, D., Thomas, G., Dickson, A., Buckley, J., Blackmore, R., Kimberley, N., ... Johnson, S (2005). *The rough guide to classical music*. London: Rough Guides.
- Stearns, M. W. (1958). *The Story of Jazz*. New York: Oxford University Press.
- Stern, M. (2001). *Mike Stern – instructional DVD*. [DVD] Milwaukee: Hal Leonard
- Stowell, J. (2005). *Jazz guitar mastery*. Pacific: Mel Bay.
- Sudnow, D (2001). *The ways of the hand – a rewritten account*. Cambridge, Mass: MIT Press.
- Summerfield, M. J. (1978). *The jazz guitar: its evolution and its players*. Gateshead: Ashley Mark.
- Sutherland, J., Sutherland, B.J., Hoge, D., Groeber, P. & Goni, A. (2011) *Everybody's classical guitar*. Fort Lauderdale: The FJH Music Company.
- Tabler, J and Grundy, S. (1983) *The guitar greats*. London: British Broadcasting Corporation.
- Taylor, M. (2016). *Martin Taylor demonstrates how to achieve counterpoint with finger-style guitar*. [Multimedia] Retrieved from:  
<https://www.youtube.com/watch?v=31pHidEBdk4>
- Tenant, S (2006). *Pumping nylon: the classical guitarist's technique handbook*. Van Nuys: Alfred.
- Tenant, S. (2003). *Basic classical guitar method*. Van Nuys: Alfred

- Thomas, J (2002). *Voice leading for guitar: moving through the changes*. Boston: Berklee Press.
- Turnbull, H. (1991). *The guitar: from the renaissance to the present day*. Westport: The Bold Strummer.
- Vaught, L. (2017) Agustin Barrios Mangore biography. *All Music*. Retrieved from: <http://www.allmusic.com/artist/agust%C3%ADn-barrios-mangor%C3%A9-mn0002167775/biography>
- Van Eps, G. (1980). *Harmonic mechanisms for guitar: vol 1*. Pacific: Mel Bay
- Van Eps, G. (1981). *Harmonic mechanisms for guitar: vol 2*. Pacific: Mel Bay
- Van Eps, G. (1982). *Harmonic mechanisms for guitar: vol 3*. Pacific: Mel Bay
- Vardanyan, G (2013). *Complete warm-up for classical guitar*. Pacific: Mel Bay.
- Vardanyan, G (2014). *Killer technique: classical guitar*. Pacific: Mel Bay.
- Vernon, P. (2003). *Jean 'Django' Reinhardt: a contextual bio-discography*. Aldershot: Ashgate.
- Vincent, R. (2011). *Jazz guitar voicing series: three note voicings and beyond*. Petaluma: Sher Music.
- Vincent, R (2009). *Jazz guitar voicings volume 1: the drop II book*. Petaluma: Sher Music.
- Vincent, R (2012). *Line games: an in-depth study of single-note lines for guitar*. Petaluma: Sher Music.
- Vincent, R (2014). *Jazz guitar soloing: the cellular approach*. Pentaluma: Sher Music.
- Wade, G (2001). *A concise history of the classical guitar*. Pacific: Mel Bay.
- Weil, G (2003). *Conceptos de la armonia contemporanea aplicados al jazz y la musica popular*. Caracas.
- Williams, J. (2005, 30 Sep) *Interview with John Williams*. Guitar Player online article. Retrieved from: <http://www.guitarplayer.com/artists/1013/john-williams/19162>
- Wills, A. & Quine, H. (1978). *The contemporary guitarist*. London: Ricordi.
- Wise, L. (2001). *Jazz improvisation for guitar*. Milwaukee: Hal Leonard
- Wyble, J. (2001). *The art of two-line improvisation*. Pacific: Mel Bay.
- Wyble, J. (2001). *Concepts for the classical and jazz guitar*. Pacific: Mel Bay.

Zaytsev, I. (Producer) (2013, 5 September). *Charlie Byrd: contemporary caoustic jazz guitar*. [Multimedia]. Retrieved from <https://www.youtube.com/watch?v=-jAHuJvXqzw>

## Discography

- Barrios Mangore, A. (2001). *Agustion Barrios Mangore – the complete guitar recordings 1913 – 1942*. [CD] Fenton: Mel Bay.
- Bream, J. (2001). *Spanish guitar music*. [CD] Berlin: Westminster Legacy.
- De la Maza, R. (1949). *Concierto de Aranjuez – with the National Orchestra of Spain*. [CD] Chanterelle.
- Diaz, A. (1994). *Five centuries of Spanish guitar music*. [CD] Hallandale: Essential Media
- Fripp, R./King Crimson. (1969). *In the court of the crimson king*. [CD] New York: Atlantic
- Fripp, R. and Summers, A. (1982). *I advance masked*. [CD] Santa Monica: A&M
- Frisell, B. (2009). *The best of Bill Frisell, volume one – folk songs*. [CD] Burbank: Nonesuch
- Frisell, B. (2006). *Bill Frisell, Ron Carter, Paul Motian*. [CD] Burbank: Nonesuch.
- Gambale, F. (1994). *Passages*. [CD] Yokohama: JVC
- Gambale, F./Chick Corea Electric Band (1987). *Light years*. [CD] New York: GRP
- Holdsworth, A. (1983). *Road Games*. [CD] Burbank: Warner Bros
- Holdsworth, A. (1985). *Metal Fatigue*. [CD] Culver City: Enigma
- Holdsworth, A. (2000). *The sixteen men of tain*. [CD] Gnarly Geezer
- Llobet, M. (2004). *Miguel Llobet guitar music*. [CD] Hong Kong: Naxos.
- Llobet, M. (2012). *Miguel Llobet – classical guitar masters of the 1920s* [CD] Essential World Masters.

Martino. P. (1967). *El hombre*. [CD] New York: Prestige

Martino, P. (2001). *Live at Yoshi's*. [CD] New Orleans: Blue Note

Mclaughlin, J./Davis, M. (1969). *In a silent way*. [CD] New York: Columbia

Mclaughlin, J./The Mahavishnu Orchestra. (1971). *The inner mountin flame*. [CD] New York: Columbia

Mcclaughlin, J./Shakti. (1975). *Shakti*. [CD] New York: Columbia

Metheny, P. (1976). *Bright Size Life*. [CD] Munich: ECM

Metheny, P. (2005). *The way up*. [CD] Burbank: Nonesuch

Metheny, P. (2010). *Orchestrion*. [CD] Burbank: Nonesuch

Presti, I. (2013). *The art of ida presti*. [CD] Hong Kong: Idis/Naxos

Pujol, E. (1954). *Spanish songs – a historical live recording of the 1954 Madrid recital*. [CD] Madrid: Emec.

Ritenour, L. (1990). *Stolen moments*. [CD] New York: GRP

Ritenour. L. (2010). *Six string theory*. [CD] Beverly Hills: Concord

Russell, D. (2008). *David Russell plays Baroque music*. [CD] Beverly Hills: Telarc.

Russell, D. (2004). *Aire Latino*. [CD] Beverly Hills: Telarc.

Segovia, A. (2002). *The art of Segovia*. [CD] London: Gramophone.

Taylor, M. (2001). *Solo*. [CD] Denver: P3

Taylor, M. (2005). *The best of Martin Taylor*. [CD] Denver: P3

Walker, M. (2008). *Madhouse and the whole thing there*. [CD] Hidden Idiom

Walker, M./The Impossible Gentlemen (2011). *The impossible gentlemen*. [CD] London: Basho

Williams, J. (2011). *The guitarist*. [CD] Munich: Sony