

Modelling the Response of Single Passive Piles Subjected to Lateral Soil Movement using PLAXIS

Ihsan Al-Abboodi, Tahsin Toma-Sabbagh and Ali Al-Jazaairry
School of Computing, Science and Engineering,
University of Salford,
UK

Abstract—Response of single pile subjected to lateral displacements of soil mass using 3D finite element software (PLAXIS) is studied. Embedded pile feature in which the pile composed of beam elements with special interface elements to represent pile-soil interaction is used. The Mohr–Coulomb elastic–plastic constitutive model was employed for the soil stress-strain behaviour. A good agreement between laboratory and predicted results is observed in the validation analysis. A parametric study was conducted to investigate the influence of soil Young's modulus and soil movement profile on the response of single "passive pile". The software results revealed that the distribution of bending moment along the pile length vary considerably and was in a very good agreement with the real pile behaviour when adopting a variation of soil elastic modulus with depth instead of choosing a constant value.

Keywords—Passive pile; lateral soil movements; PLAXIS; finite element analysis; soil Young's modulus

I. INTRODUCTION

Some construction activities and natural phenomena induced lateral "hidden loading" on pile foundations. This kind of loading is caused by lateral movement of the surrounding ground and is called passive loading and the piles subjected to these loadings are known as "passive piles".

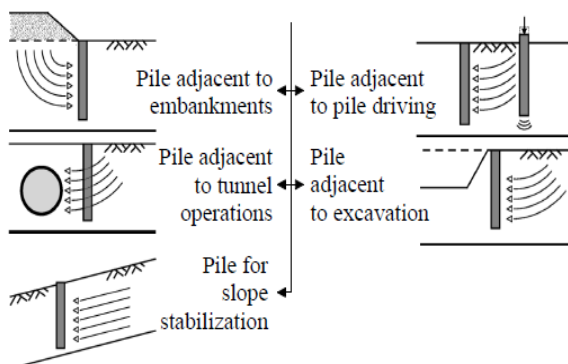

Fig. 1: Examples of Passive Piles [1]

Buildings with passive piles can be seen on unstable soil layers or nearby excavation activities, pile driving operations, surcharge loads and tunnelling operations (Fig. 1).

Passive pressures and relative soil-pile displacements play an essential role in the behaviour of piled foundations and may induces deflections and bending moments which can cause serviceability problems and even damage to the passive piles [2] and [3]. One of the most famous damage caused by horizontal soil movement is the collapse of 13-storey building in China in 2009 under nearby surcharge loading and excavation works [4] as shown in Fig. 2. Most of the researches in the literature have interested in piled foundations as settlement reducers and external load supports. Although this is true in the case of stable soil layers, knowledge of deformations caused by external vertical and horizontal loads only may not be enough for those buildings existing adjacent to soil movement activities.



Fig. 2: Collapse of 13-Storey Building [4].

A number of analytical simulations with 2D or 3D analysis have been used to assess the behaviour of piles to horizontal ground movements. For example, Poulos [5] carried out a boundary element solution for single piles subjected to horizontal ground movements using Mindlin's solution. Bransby and Springman [6], proposed a 3D finite element analysis to study the response of piles adjacent to a surcharge load. Pan, Goh, Wong, and The [7] used the finite element software ABAQUS with von Mises model to represent the non-linear behaviour of the soil in order to

study the ultimate soil pressure acting on piles undergoing lateral soil mass movements. Chen and Martin [8], studied the mechanism of load and stress transfer from the soil to passive pile group by linking pile load-displacement curves and the arching effects using the finite difference code FLAC3D. Ghee and Guo [9], carried out a 3D finite difference analysis using FLAC3D software to investigate the response of single pile subjected to direct soil movement. Zhang and Li [10], used the 3D finite element software ANSYS to study the bending response of axially loaded pile group under lateral ground movements taking into account the effect of pile cap. The soil and pile were modelled as a Drucker-Prager and linear materials respectively with 8-node hexahedron elements. In this study, a finite element package (PLAXIS 3D-Introductory version 2013) has been utilized to predict the behaviour of single pile under lateral movement of soil mass.

II. PLAXIS 3D MODELLING

The pile is represented using "Embedded Pile" feature. Embedded pile is a beam element covered by special interfaces (foot interface and skin interface) to represent the pile-soil interaction. Therefore, using this feature leads to great reduction in the number of elements in the analysis compared to volume pile. Hence, the time required to perform the analysis is considerably decreased. Comparing the response of this type of piles for axial loading shows a good agreement with volume pile and real pile behaviour [11] and [12]. However, it is still not clear whether the embedded pile can be used sufficiently to simulate the pile response in the situation of being subjected to lateral loading caused by soil movements [13].

III. BOUNDARY CONDITIONS

Standard fixities are applied during initial phase in which the bottom nodes of the soil were restrained to move in X, Y and Z directions, while top soil surface was free to move. The nodes at both right and left faces were restricted to move in the X direction. During lateral loading, a prescribed displacement of 60 mm was applied on the nodes at both sides from left to right. An interface surface has been added in between the slide and stable soil layers. The interface properties play an essential role in such problems involving relative soil-pile displacements. The movement of the nodes at the slip plane increases with reducing interface strength, and is similar to the soil boundary movement when the interface strength is zero or closed to zero. In the present study, interface surface with approximately zero strength slip plane is used by choosing a minimum value (0.01) of the reduction factor (R_{int}) as recommended by Kanagasabai, [14], where (R_{int}) is a value gives a reduction interface friction and interface cohesion compared to the friction angle and cohesion in the adjacent soil.

IV. VERIFICATION WITH LABORATORY TEST RESULTS

In the present study, a part of the laboratory tests that carried out by Ghee [15] has been chosen in order to validate the proposed procedure. A schematic diagram of the shear box and the loading system is illustrated in Fig. 3.

The technique adopted to apply lateral loads induced soil movements in laboratory tests usually carries out by dividing the soil in the tank into two layers. The soil in the lower part of the tank is fixed while that in the upper part is forced by applying lateral loading system caused movement to this part of soil. The profile of this movement takes several shapes depend on the design of the tank and the shape of loading blocks attached to the lateral loading system.

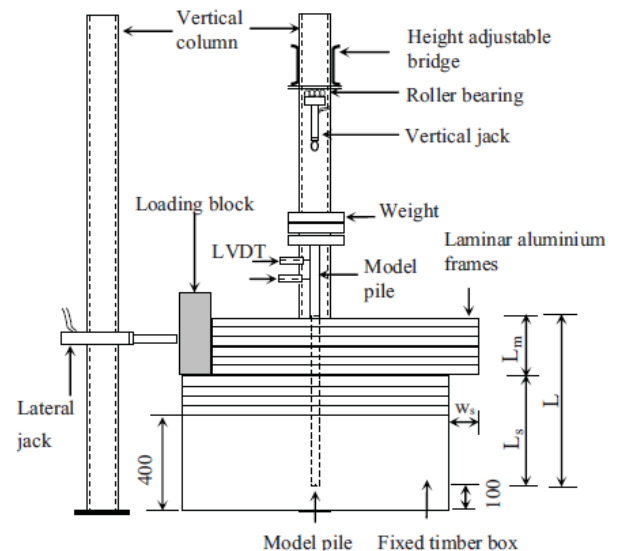

Fig. 3: Physical Model Test Setup, Ghee [15]

The shear box had dimensions of (1x1x0.8m) with sliding depth (L_m) and stable depth (L_s) was maintained as 400mm and 300mm respectively. The model test was conducted on a single pile subjected to uniform profile of lateral soil movement. Free-head and free-tip aluminium instrumented pipe is embedded through soil box. The pile had overall length of 1200 mm with outer diameter of 50 mm and wall thickness of 1.0 mm. Young's modulus of $7.0 \times 10^{10} \text{ N/m}^2$ and Poisson's ratio of 0.3 have been used in the analysis of the pile. A Mohr-Coulomb elastic-plastic constitutive model was assumed for the soil. The properties of the sand used in the tests are illustrated in Table 1.

In the model tests, the bending moment, shear force, and the deflection versus depth profiles were recorded for the model pile throughout the application of external lateral load induced rectangular movement of soil mass up to 60 mm. Soil and structure finite element simulation were conducted as shown in a snapshot in Fig. 4.

TABLE 1 PHYSICAL PROPERTIES FOR THE TESTED SAND

Property	Value
Test unit weight, γ_d	16.27 kN/m ³
Coefficient of earth pressure at rest, K_0	$1 - \sin\phi = 0.3843$
Angle of friction ϕ	38°
Angle of dilation Ψ	8°
Young's modulus E_s	572 kPa
Poisson's ratio	0.3

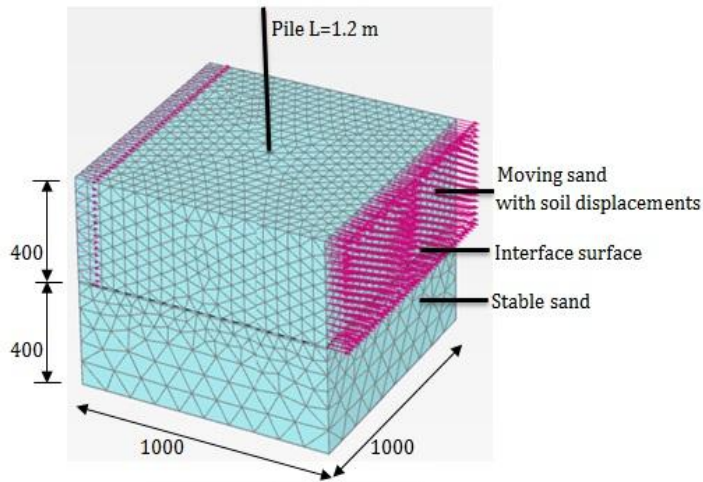

Fig. 4: Finite Element Simulation and Dimensions of the problem

V. RESULTS AND DISCUSSIONS

A uniform lateral sand displacement of 60 mm was applied to the nodes on the left and right boundaries down to the bottom of the moving sand. The comparison has been conducted with the experimental results profiles represent bending moment and shear force acting along the pile length. Another comparison was conducted with FLAC^{3D} software results carried out by Ghee and Gou [9].

Fig. 5 shows PLAXIS, FLAC^{3D} results together with the measured results of the bending moment profile along the pile. It can be seen that the numerical results of PLAXIS are in good agreement with Ghee' laboratory results especially for the portion of the pile above the sliding depth and, also, the trend of the behaviour. The position of zero bending movement has been determined successively and more accuracy compared to FLAC^{3D}. However, for the portion under the sliding depth, the predicted maximum bending moment is underestimated by 140 %. This difference can be attributed to the use of average value of Young's modulus ($E_s = 572$ kPa) of the soil instead of finding a relationship between Young's modulus and soil depth in the laboratory tests.

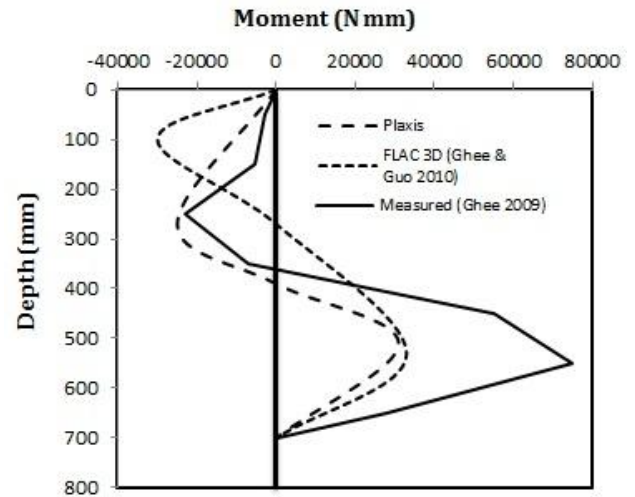

Fig. 5: Predicted and Measured Bending Moment Along the Pile

The predicted and experimental results of the shear forces acting on the pile are presented in Fig. 6. The predicted profile obtained by PLAXIS agreed sufficiently with that measured by Ghee [15], including the position (which is closed to the interface surface between stationary and sliding layers) and the magnitude of maximum shear force.

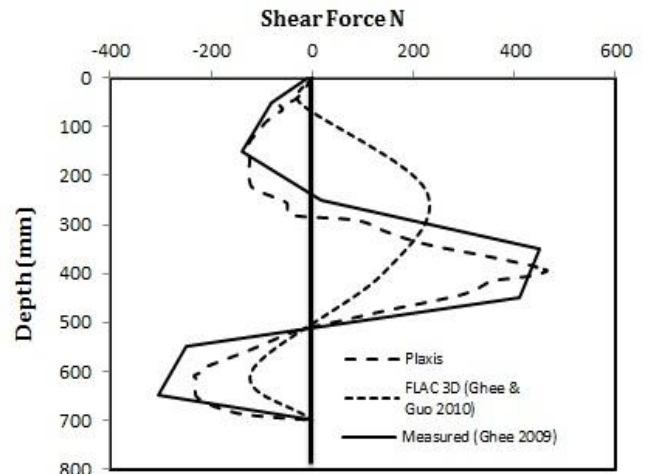

Fig. 6: Predicted and Measured Shear Force Along the Pile

Fig. 7 illustrates the deflection profiles of the pile. It can be noticed that both analytical and measured results show behaviour like a rigid pile with a rotational point located closed to the pile tip. The deflection profile predicted along the pile length including the magnitude of maximum deflection at soil surface by PLAXIS showed close matching with the test results.

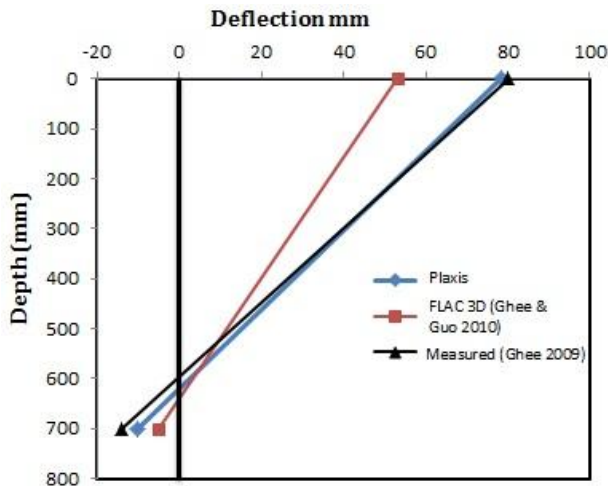

Fig. 7: Predicted and Measured Deflection Along the Pile

VI. PARAMETRIC STUDY

In order to complement existing knowledge related to pile-soil interaction in the case of lateral soil movements, a parametric study was conducted. The parameters considered include soil Young's modulus and soil movement profile. The same input data for the previous example have been used.

A. Effect of Soil Young's Modulus

In sand, it is normally assumed that Young's modulus is proportional to the depth z . Hence, the effect of soil Young's modulus on the response of single pile under soil mass displacement is evaluated by changing the average value of Young's modulus which is already used previously to values change linearly with soil depth from $E_s = 2z$ to $3z$ and $4z$, where z in m and E_s in MPa.

Fig. 8 shows the change in pile bending moment with the varying Young's modulus-depth relationship of the sand.

In general, as the soil elastic modulus increases, the bending moments induced on pile surface also increase. The shape of bending moment profiles appear close to the real behaviour of the tested pile especially for that portion under the sliding depth. The calculated maximum bending moment is significantly greater as compared to a constant E_s assumed for all depth. Therefore, it can be said that the variation of soil elastic modulus has a significant influence on bending moments induced on pile.

B. Effect of Soil Movement Profile

Fig. 9 shows the distribution of bending moment along the pile length for three types of soil displacement profiles i.e. uniform, triangular and trapezoidal with the same lateral movement of soil surface up to 60 mm at both sides of the boundaries. It can be seen that both triangular and trapezoidal profiles induced semi-parabolic shapes of positive bending moment with maximum value closed to the position of interface between sliding and stable layers. On the other hand, uniform displacement profile caused negative and positive moments. The point of inflection (zero bending moment) was located closed to the interface surface, while the point of maximum bending moment was situated within the stable layer

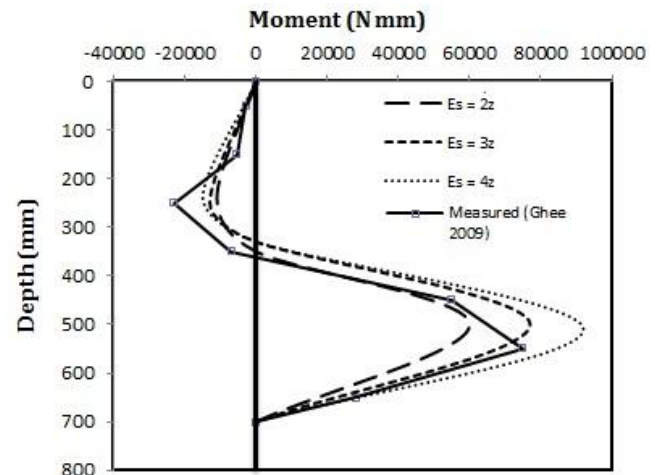

Fig. 8: Pile Response at Different Young's Modulus-Depth Ratios of the Soil

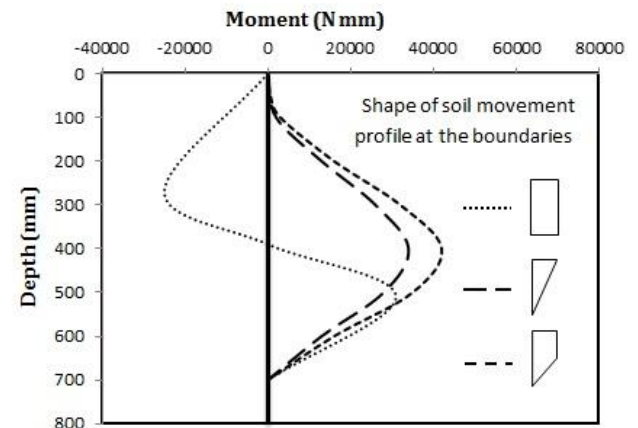

Fig. 9 Pile Response at Different Soil Movement Profiles

VI. CONCLUSIONS

This paper describes an analytical solution for predicting the lateral response of "passive piles" subjected to horizontal soil movements by utilising PLAXIS 3D finite element software. An "embedded pile" concept is used in order to highlight its ability to predict the behaviour of single pile under soil movements. The accuracy of the proposed analysis has been verified by back analysing of laboratory test results. A parametric study has also been conducted to investigate the effects of soil Young's modulus and soil movements profile on pile response. The results of this study showed that an accurate assessment of soil Young's modulus is vital to satisfactory prediction of the bending moments acting along pile length. This includes the position and the magnitude of maximum bending moment. In addition, the parametric study revealed that soil movement profile is an important factor to determine the behavioural mode of the pile.

REFERENCES

- [1] J. Bauer, H.G. Kempfert, and O. Reul, "Lateral pressure on piles due to horizontal soil movement -1 g model tests on single piles and pile rows," Proceedings of the 8th International Conference on Physical Modelling in Geotechnics, (ICPMG2014), Perth, Australia, January 2014.
- [2] J. Pan, A. Goh, K. Wong, and A. Selby, "Three-dimensional analysis of single pile response to lateral soil movements," International Journal for Numerical and Analytical Vol. 26, No. 8, 2002, pp. 747–758.
- [3] R.J. Finno, S.A. Lawrence, N.F. Allawh, and I.S. Harahap, "Analysis of performance of pile groups adjacent to deep excavation," Journal of Geotechnical Engineering, Vol. 117, No. 6, 1991, pp. 934-955.
- [4] F. Liang, F. Yu, and J. Han, "A simplified analytical method for response of an axially loaded pile group subjected to lateral soil movement," KSCE Journal of Civil Engineering, Vol. 17, No. 2, 2013, pp. 368-376.
- [5] H.G. Poulos, "Analysis of piles in soil undergoing lateral movement," Journal of the Soil Mechanics and Foundations Division, ASCE, Vol. 99, No. 5, 1973, pp 391-406.
- [6] M.F. Bransby, and S.M. Springman, "3-D finite element modelling of pile groups adjacent to surcharge loads," Computers and Geotechnics, Vol. 19, No. 4, 1996, pp. 301-324.
- [7] J. Pan, A.T.C Goh, K.S. Wong, and C.I. Teh, "Ultimate soil pressures for piles subjected to lateral soil movements," Journal of Geotechnical and Geoenvironmental Engineering, ASCE, Vol 128, No. 6, 2002, pp. 530–535.
- [8] C.Y. Chen, and G.R. Martin, "Soil-structure interaction for landslide stabilizing piles," Computers and Geotechnics, Vol. 29, No. 3, 2002, pp. 363–386.
- [9] H. Ghee, and W.D. Guo, "FLAC3D analysis on soil moving through piles," Proceedings of the 2nd international symposium on frontiers in offshore geotechnics, Perth, Australia, November 2010.
- [10] Z.F. Zhang, and J.P. Li, "Analysis of Piles Subject to axial load and lateral soil movement," International conference on electrical engineering and automatic control (ICEEAC2010), 2010.
- [11] J. Sluis, F. Besseling, P. Stuurwold, and A. Lengkeek, "Validation and application of the embedded pile row- feature in PLAXIS 2D," Plaxis Bulletin, Issue 34, 2013, pp 10-13.
- [12] B.B. Sheil, and B.A. McCabe, "Predictions of friction pile group response using embedded piles in PLAXIS," The 3rd International Conference on New Developments in Soil Mechanics and Geotechnical Engineering, Near East University, Nicosia, North Cyprus, June 2012
- [13] T.P.T Dao, "Validation of PLAXIS embedded piles for lateral loading," Master of Science Thesis, Delft University, 2011.
- [14] S. Kanagasabai, "Three dimensional numerical modelling of rows of discrete piles used to stabilise large landslides," Doctoral Thesis, University of Southampton, 2010.
- [15] H. Ghee, "The Behaviour of Axially Loaded Piles Subjected to Lateral Soil Movements," Doctorate Thesis, Griffith University, Australia, 2009.