

**Enhancing the Energy Efficiency of Ultra WideBand (UWB) Based Media
Access Control (MAC) protocols in Mobile Ad-Hoc Networks (MANETs)
through the Use Of Steerable Directional Antenna**



MURTALA MUHAMMAD

**Submitted in Partial Fulfilment of the Requirement for the Degree of
Doctor of Philosophy (PhD) in Computer Networks and
Telecommunications**

2017

Table of Contents

Table of Contents	ii
List of Figures	vii
List of Tables	ix
List of Equations	x
Abbreviations and Annotations.....	xi
Acknowledgements.....	xiv
Dedication	xvi
Abstract	xvii
Chapter One	1
1.0 Introduction	1
1.1 Statement of the Problem	3
1.2 Research Motivation	4
1.3 Research Aim and Objectives	4
1.3.1 Aim	4
1.3.2 Objectives	5
1.4 Research Methodology.....	5
1.5 Thesis Organisation.....	10
Chapter Two.....	12
2.1 Background Study	12
2.2 Ad hoc Networks.....	12
2.3 Wireless Mobile Ad hoc Networks	13
2.4 Generations of Wireless Mobile Ad hoc Network	15
2.4.1 First Generation Wireless MANETs	15
2.4.2 Second Generation Wireless MANETs.....	16
2.4.3 Third Generation Wireless MANETs.....	17
2.5 Wireless Mobile Ad hoc Design	18
2.6 ULTRA WIDWBAND (UWB)	19
2.7 A Brief History of UWB Technology	21

2.8 Types of UWB Systems	23
2.9 How UWB Works	24
2.10 Applications of UWB systems	27
2.11 MEDIUM ACCESS CONTROL (MAC) PROTOCOLS	29
2.12 MEDIUM ACCESS CONTROL FRAME FORMAT.....	31
2.13 General MAC Frame Format	33
2.13.1 MAC Beacon Format	33
2.13.2 MAC Command Frame	34
2.13.3 Data Frame Format.....	34
2.13.4 Acknowledgement Frame Format	34
2.13.5 Types of MAC Protocols	35
2.14 MAC Protocols for MANET.....	39
2.15 MAC Protocol Analysis	40
2.16 IEEE 802.15.3 AS A PROTOCOL FOR IMPLEMENTATION.....	42
2.17 Power Conservation	44
2.18 Power Conservation Models	46
2.19 Directional Antenna for MANET	47
2.20 Chapter Summary.....	51
Chapter Three.....	52
3.0 Literature Review	52
3.1 Introduction	52
3.2 Mobile Ad hoc Networks - Existing Challenges.....	52
3.3 MANET in-depth Characteristics.....	57
3.4 Ultra WideBand (UWB) Technology	58
3.5 Applications of UWB Technology in MANET	63
3.6 UWB MAC in MANET	65
3.7 Role of UWB MAC on Routing in MANET	67
3.8 The Role of UWB-MAC to improve Quality of Service in MANET.....	68
3.9 Review of Power Management Techniques in MANET	70
3.10 Choice of MAC protocol for MANET	74
3.11 IEEE 802.15.3 Overview	77
3.11.1 IEEE 802.15.3 for MANET.....	78
3.12 Power parameters for UWB-MAC in MANET	81

3.12.1	Sources for energy in-efficiency in MANET.....	81
3.12.2	UWB Parameters and Matrices.....	82
3.13	UWB Transmission Techniques at the MAC Layer	88
3.14	Advantages of using Directional Antennas in MANET to save Energy.....	88
3.15	Basic Assumption.....	90
3.16	Summary of review	90
3.17	Preliminary testing of the proposed protocol using QualNet simulator.....	92
3.18	Analysis of the Proposed UWB-MAC with Simulator	92
3.19	Performance Evaluation	94
3.20	Summary of Analysis	100
Chapter Four	102
4.0	Design.....	102
4.0.1	UWB-MAC Design with Directional Antenna	102
4.0.2	Tailoring MAC to Directional Systems in MANET	102
4.1	Proposed Model Constraints	103
4.2	Propose Model Modification.....	104
4.2.1	Traffic Modelling	104
4.2.2	Model Formulation.....	107
4.3	Parameters consideration and model formulation	113
4.3.1	Model Validation.....	114
4.4	Analytical Model.....	116
4.5	Numerical Evaluation of the Proposed Model	124
i.	Change in Power with Respect to Number of Request (R).....	125
ii.	Change in Power with Respect to Distance (d).....	127
iii.	Change in Power With Respect to Propagation Channel (α)	128
iv.	Change in Power With Respect to Antenna High (H).....	131
v.	Change in Power With Respect to Directivity (D).....	133
vi.	Change in Power With Respect to Constant Bitrate (c)	136
4.6	Discussion	138
4.7	Chapter Summary.....	139
Chapter Five	140
5.0	Framework, Implementation and Algorithm.....	140
5.1	Introduction	140

5.2 Framework of the Proposed Protocol.....	141
5.3 Transmission Implementation	144
5.4 Channel and Modulation Techniques Applied to the Transmitters	145
5.5 Receiver Implementation	149
5.6 Multiband-OFDM Implementation on the MIMO Configuration	151
5.7 Asynchronous Power Saving (APS) Model.....	155
5.8 Asynchronous Power saving algorithm for UWB-MAC with Steerable Directional Antenna	156
5.9 State-based Energy Consumption Model.....	159
5.10 State-based Energy Saving Schematic Algorithm for the Proposed UWB-MAC	161
5.11 Chapter Summary.....	163
Chapter Six.....	164
6.0 Simulation	164
6.1 Introduction	164
6.2 Overview of Network Simulator-3 (NS-3)	164
6.3 Simulation Parameters.....	167
6.4 Results and Discussions	169
6.4.1 Saturated Performance Throughput.....	170
6.4.2 Collision Rate	172
6.4.3 Average Channel Access Delay	174
6.4.4 Packet Delivery Ratio.....	176
6.4.5 Total Energy Consumed	178
6.5 General Discussion of Results.....	182
6.6 Chapter Summary.....	185
Chapter Seven	187
7.0 Summary and Conclusion	187
7.1 Research Difficulties and Recommendations	191
7.2 Research Limitation	192
7.3 Future Work	192
7.5 Research Accomplishments	194
7.6 Concluding Remarks	195
References.....	197

Appendices.....	210
Appendix A	210
Numerical Evaluation of Existing and Proposed Model	210
Testing model for communication using MATLAB	222
Appendix B	223
Justifications of using numerical values to test the proposed model.....	223
Appendix C	225
Physical and Channel testing and results.....	225
Appendix D	227
Linking MATLAB Simulink with ns-3	227
Some Simulation setup and Scenarios	228
Appendix E.....	231
Publications	231
Appendix References	231

List of Figures

Figure 1.1: Process flow Diagram	6
Figure 2.1: Wireless Mobile Ad hoc Network [17]	14
Figure 2.2: FCC UWB comparison with other Systems [20]	21
Figure 2.4: FHSS Transmitter and Receiver Diagram.....	24
Figure 2.5: DSS Diagram Transmitter and Receiver Diagram	24
Figure 2.6: The DS-UWB Transmission Plot.....	25
Figure 2.7: Biphase Impulse Modulation.....	26
Figure 2.8: Application of UWB systems according layers of the OSI Model	28
Figure 2.9: General Wireless MAC Frame Structure	32
Figure 2.10: Structure of a Beacon Frame Format	33
Figure 2.11: Structure of MAC Command Frame	34
Figure 2.12: Data Frame Format.....	34
Figure 2.13: Acknowledgement Frame Format	35
Figure 2.14: S-MAC protocol operation[29]	36
Figure 2.15: B-MAC operation example[29].....	37
Figure 2.16: MANETs MACs and Sub-categories	40
Figure 2.17: IEEE 802.15.3 Super Frame	43
Figure 3.1: MANET Summary of Existing Challenges.....	54
Figure 3.2: Analysis of existing challenges of MANET from 2000 to 2017.....	56
Figure 3.3: Mobile Ad hoc Network (MANET)	60
Figure 3.4: UWB features, applications and performance output	62
Figure 3.5: IEEE 802.15.3 Super Frame Structure	79
Figure 3.6: Omni and Directional System	89
Figure 3.7: Scenario Design for Preliminary Testing of the Proposed Model.....	92
Figure 3.8: Packet Dropped Analysis	95
Figure 3.9: Energy consumed at the MAC Layer	96
Figure 3.10: Total Battery Charge Consumed	97
Figure 3.11: Goodput Comparison	99
Figure 3.12: Goodput Comparison	99
Figure 4.1: Density Structure of a Network.....	105
Figure 4.2: Existing Model Frame Work.....	107
Figure 4.3: Modified Frame Work.....	107
Figure 4.4: Orthogonal Frequency Division Multiplexing (MB-OFDM) Model	108
Figure 4.5: Transmission with Omni[107].....	111
Figure 4.6: Omni Directional with sectors[107]	112
Figure 4.7: Directional Transmission	113
Figure 4.8: Network appearance of the setup	121
Figure 4.9: New model communicational with Omni System.....	122
Figure 4.10: New model communicational with Directional System.....	123
Figure 4.11: Energy consumed WRT Change in Number of Request (R)	126
Figure 4.12: Energy consumed WRT Change in distance (d)	127
Figure 4.13: Energy consumed WRT Change in Propagation (α).....	129

Figure 4.14: Energy consumed WRT Change in α against Network Density	130
Figure 4.15: Energy consumed WRT Change in Antenna Height (H)	131
Figure 4.16: Energy consumed WRT change in H against network density	132
Figure 4.17: Energy consumed WRT Change in Directivity (D)	134
Figure 4.18: Energy consumed WRT change in D against network density	135
Figure 4.19: Energy consumed WRT Change in Constant Bitrate (C).....	137
Figure 4.20: Energy consumed WRT change in C against network density	138
Figure 5.1: Framework of the Proposed UWB-MAC with Steerable Direction Antenna	142
Figure 5.2: Framework of the Proposed UWB-MAC with Steerable Direction Antenna	142
Figure 5.3: Transmission Path	145
Figure 5.4: Channel Connection	146
Figure 5.5: UWB Channel	147
Figure 5.6: Reception Path.....	150
Figure 5.7: Complete PHY Stack.....	151
Figure 5.8: Multi-Band OFDM Physical Layer.....	152
Figure 5.9: OFDM Modulation Pattern	153
Figure 5.10: MB-OFDM BER vs SNR Implementation	154
Figure 5.11: Asynchronous Scheme of the Proposed UWB-MAC	157
Figure 5.12: General State-based Model	159
Figure 5.13: Graphical Representation of the Proposed State-base UWB-MAC.....	160
Figure 5.14: Simplified State Diagram of the Proposed UWB-MAC	161
Figure 5.15: State-based Energy Saving Algorithm for the Proposed UWB-MAC	162
Figure 6.1: Saturated Bandwidth Throughput for all Nodes in Active Mode	171
Figure 6.2: Collision Analysis for both Proposed and Existing Model	173
Figure 6.3: (a),(b) Connection Delay with data and VoIP using Omni and Directional Antenna	175
Figure 6.4: (a),(b) Packet delivery Ratio with Data and VoIP using Omni and Directional Antenna	177
Figure 6.5: Total Energy Consumed in Joules with Data and VoIP	179
Figure 6.6: (a),(b) Total Energy Consumed in Joules with Data and VoIP using APS and DSPS Mode.....	180
Figure 6.7: Total Energy Consumed in Joules with data and VoIP using APS and DSPTS Mode.	182

List of Tables

Table 2.1: OFDM operational band group with Band ID and Centre Frequency.....	26
Table 2.2: Summary of wireless sensor networks MAC protocols	38
Table 2.3: MACs analysis based on power consumption rate	41
Table 2.4: Omni and Directional antenna Properties.....	50
Table 3.1: Analysis of existing challenges of MANET from 2000 to 2017	55
Table 3.2: Characteristic of MANET.....	58
Table 3.3: Characteristics of MAC Protocols	66
Table 3.4: UWB-MAC protocols for MANET.....	76
Table 3.5: Spectrum Properties.....	86
Table 3.6: Simulation Parameters for Omni System	93
Table 3.7: Simulation Parameters for UCAN approach and Proposed MAC.....	93
Table 3.8: Summary of Analysis	100
Table 4.2: Multiband-OFDM Table System Characteristic.....	114
Table 4.3b: Numerical values used for validating the System.....	125
Table 6.1: (a) Parameter setting for UCAN standard with Omni-Directional Antenna	168
Table 6.2: Saturated Throughput Performance for Minimum and Maximum Percentage Difference	172

List of Equations

Equation 3.1: General UCAN Equation.....	84
Equation 3.2: Power Equation	84
Equation 3.3: Signal Transmission Equation.....	85
Equation 3.4: Random Number Generator	85
Equation 4.1: Power with respect to Density.....	109
Equation 4.2: Power with respect to Distance	109
Equation 4.3: Combining density and distance with constant C	110
Equation 4.4: Transmission with Directivity.....	110
Equation 4.5: New model of Directivity.....	111
Equation 4.6: UWB Equation	115
Equation 4.7: Distance with Constant Propagation	115
Equation 4.8: Distance with Constant Propagation and Directivity	116
Equation 4.9: Free Space Fading Equation.....	117
Equation 4.10: New Model for Analysis	118
Equation 4.11: Angle of Transmission Equation.....	118
Equation 4.12: Energy Conservation Model.....	119
Equation 4.13: Antenna Gain relationship with Efficiency and Directivity	120
Equation 4.14: How determine G with respect to H.....	120
Equation 4.15: Proposed Energy Conservation Model.....	121
Equation 4.16: Change in Density (R).....	126
Equation 4.17: Change in Distance (d).....	128
Equation 4.18: Change in Propagation (α).....	129
Equation 5.1: Input/output System of the MIMO Channel.....	147
Equation 5.2: Resulting Equation of the Channel Model	148
Equation 5.3: Channel Coefficient of the Channel	148

Abbreviations and Annotations

ADC	Analog-to-Digital Converter
ALOHA	Area Location of Hazardous Atmosphere
APS	Asynchronous Power Saving
ATIM	Ad hoc Traffic Indication Message
ATM	Asynchronous Transfer Mode
BER	Bit Error Rate
CAP	Contention Access Period
CBR	Constant Bit Rate
CCA	Clear Channel Assessment
CFP	Contention-Free Period
CP	Closed Proximity
CRC	Cyclic Redundancy Check
CSMA/CA	Carrier Sense Multiple Access with Collision Avoidance
CSMA/CD	Carrier Sense Multiple Access with Collision Detection
CSMA	Carrier Sense Multiple Access
CTA	Channel Time Allocation
CTS	Clear To Send
DAC	Digital-to-Analog Converter
DARPA	Defence Advance Research Project Agency
DCF	Distributed Coordinate Function
DCF	Distributed Coordinate Function
DSPS	Device Synchronous Power Saving
DSSS	Direct Sequence Spread Spectrum
ECMA	European Computer Manufacturer's Association
EDCA	Enhanced Distributed Channel Access
FCC	Federal Communication Commission
FCS	Frame Check Sequence
FFT	First Fourier Transformation
FHSS	Frequency-Hopping Spread Spectrum
GI	Guard Interval
GPS	Global Positioning System
GTS	Guaranteed Time Slot

GTS	Guarantee Time Slot
HCS	Header Check Sequence
HSPA	High Speed Packet Access
IEEE	Institute of Electrical Electronics Engineering
IETF	Internet Engineering Task Force
LEACH	Low-Energy Adaptive Hierarchy
LPD	Low Probability of Detection
LPJ	Low Probability of Jamming
MAC	Medium Access Control
MANET	Mobile Ad hoc NETWORK
MATLAB	MATrix Laboratory
MB-OFDM	Multi-Band Orthogonal Frequency Division Multiplexing
MB-OFDM	Multi Band Orthogonal Frequency Division Multiplexing
MC-UWB	Multi Carrier Ultra WideBand
MFH	MAC Frame Header
MIFS	Minimum InterFrame Space
MIMO	Multiple Input Multiple Output
MPDU	MAC Protocol Data Unit
MSDU	MAC Service Data Unit
MUI	Multi User Interface
NAV	Network Allocation Vector
NPSM	New Power Saving Mechanism
NS-3	Network Simulator-3
NTDR	Near Term Digital Radio
OFDM	Orthogonal Frequency Division Multiplexing
OSI	Open System Interconnects
PAMAS	Power Aware Multiple Access Protocol
PAN	Personal Area Network
PCA	Prioritised Channel Acces
PCF	Point Coordinate Function
PCI	Protocol Control Information
PPM	Pulse Position Modulation
PRNET	Packet Radio Network
PRP	Parallel Redundancy Protocol

PSM	Power Saving Mechanism
QAM	Quadrature Amplitude Modulation
QoS	Quality of Service
QPSK/TCM	Quadrature Phase Shift Keying with Trellis Coded Modulation
QPSK	Quadrature Phase Shift Keying
RFD	Reduce-Function Device
RTS	Ready To Send
RX	Reception/Receiving
SIFS	Short InterFrame Space
SIMO	Single Input Multiple Output
SNR	Signal- Noise -Ratio
SSID	Service Set Identifier
SURAN	Survivable Adaptive Radio Network
TCS	Telephone Control-protocol Specification
TDD	Time Division Duplex
TDMA	Time Division Multiple Access
TH-IR	Time Hopping Impulse Radio
T_w	Time Window
UCAN	UltraWideBand Concept for Ad hoc Networks
UWB	Ultra Wide Band
VoIP	Voice over Internet Protocol
WLAN	Wireless Local Area Network
WPAN	Wireless Personal Area Network
WWRF	Wireless World Research Forum

Acknowledgements

I wish to express my profound gratitude to my main supervisor Dr Martin Hope and my Co-supervisor Prof. Haifa Takturi-Rizk for their priceless guidance during the course of the entire research work. Dr Martin has been supportive and has given me freedom to pursue various projects without objection, also provide understanding discussion about the research. Dr. Martin the best way to describe our relationship is that, I had the privilege and opportunity to meet a real lecturer and a great man. My appreciation goes to my PhD colleagues for their support towards providing massive assistance throughout the course of this research work. My appreciation goes to every research student and staffs of computing department for their inspiration, support and willingness to share knowledge throughout the course of this piece of work.

I want to thank my major sponsors, Tertiary Education Trust Fund (TETFund) and Adamawa State University, Mubi for providing financial support for successful completion of this research study. My appreciation goes to Dr. Alkasum Abba (Former Vice Chancellor, Adamawa State University), Alhaji Bashir Abubakar (Yaya Gidado), and Dr. Dahiru Mohammad Toungos with his wife Nafisatu Muhammad Maiha (Adda Nafisa) for their support and guidance towards the completion of this research work. My appreciation also goes to Petroleum Technology Development Fund (PTDF) for providing me with top-up grant when I was affected by the exchange rate. I will not forget Uncle Tijjani Galadima and my Boss Bala Hamidu for their support towards the completion of this research work.

I want thank my Late Boss in person of Idries Adamu Song (Ihas) and all staff of Pc Klinik Nig. Ltd for their support and guidance towards the completion of this studies.

I wish to say thank you to all my family and friends especially Abdulhamid Adamu Abubakar (Dr. Jazaks), Abdullahi Jingi (Modi), Faiz Bashir, Yahya Ahmed (Yoo), Dr. Hassan Suru, Uchenna Daniel (Dan'uwa), Muhammad Abubakar (St Man), Zainab Usman Ardo (Zee-zee), Muhammad Auwal Abdullahi (kowagol), Mahmud Ahmed Usman (Malam Mahmud), Muhammad Gidado Musa (Babba), Dang Bwebum, and Mustapha Mujeli who have in one way or the other contributed to the successful completion of my studies.

This thesis writing would not be complete if I failed to express my gratitude to school of computing, science and Engineering, University of Salford, Manchester for their support and encouragement throughout my studies.

Special thanks also goes to QualNet support group, Mathswork Support Group and ns-3 Support Group for providing the necessary software and licenses used throughout this research work.

Finally, I wish to say thank you to my examiners Professor Andy Shaw (External Examiner), Dr. Steve Hill (Internal Examiner) and Professor Mark Danson (Independent chair).

Dedication

I dedicate this entire project first to GOD ALMIGHTY who has giving me good health and sound mind and made all things possible to complete this research work. And to my late parents Alhaji Muhammad Usman Maiha and Malama Bilkisu Wali for their support and courage they gave me. Also to my beloved wife Bilkisu Halilu Wali and my kids Abdullahi Murtala Muhammad, Bilkisu Murtala Muhammad (Ummu Sagirah) and Zainab Murtala Muhammad (Mami) for their patience and sincerity while I was away for studies.

Abstract

Energy efficiency contributes to the survival of nodes in Mobile Ad Hoc Networks (MANETs). The use of directional antennas can conserve energy due to the increased gain and directed transmission towards specific point in space. Directional antennas also resolve many issues associated with interference from different points within the network. Despite the vast body of work in this area, research on the way directional antennas access the wireless medium specific to Ultra-WideBand (UWB) systems have not gained wide attention. The aim of this research is to design, implement and test an improved Medium Access Control (MAC) protocol for UWB systems in order to minimise energy consumption in MANET's through the application of directional antenna.

Building on initial testing in the QualNet Simulator; a new MAC protocol design was modelled on the IEEE 802.15.3 standard using directional antennas. Specific simulation parameters were changed based on the antenna angle of transmission and reception, with a view to optimising power consumption in the network. Both analytical and simulation techniques were then used for testing and validating the improved protocol design.

Initial testing of the proposed model was completed analytically using numerical values from justifiable literature in order to validate the protocol. A comparative analysis was then conducted which considered omni-directional antenna, the Ultra-wideband Concepts for Ad hoc Networks (UCANs) approach, and the proposed MAC design. The results show that the proposed MAC protocol design outperforms other approaches in both energy conservation and data throughput in MANETs.

Final testing then considered a descriptive framework which was used to highlight the difference between the proposed MAC protocol and existing designs. A physical (PHY) layer was implemented in MATLAB prior to integrating it within the ns-3 simulator. The simulated results showed that by combining the proposed UWB-MAC protocol, with directional antenna, a significant amount of energy can be conserved to a level better than existing UWB MAC protocols. This work offers a contribution to knowledge by providing a proof-of-concept approach for optimising energy consumption, through modifying existing MAC protocols in comparison to other UCANs using directional antenna techniques.

Chapter One

1.0 Introduction

The use of wireless devices in our environment today cannot be over emphasized because of the portability of devices as well as their mobility. Therefore, the necessity for deploying a communication medium may be vital. As a result of that, mobile devices are designed to serve as a receiver and transmitter at the same time. When these devices communicate without administrative guidance, we identify it as a wireless Mobile Ad hoc Network (MANET). In general, mobile ad hoc networks are formed dynamically by a self-directed system of mobile nodes that are connected by wireless links without using any existing network infrastructure. Due to its unique features, research has shown that MANET will become the major technology in the future as a result of how the world is dramatically becoming wireless [1] .

Communication between devices in MANETs is been done without the intervention of third device(s). This leads to many challenges that required researchers to intervene in order to foster solutions to these problems. These challenges include energy conservation (high demand for energy, battery wise and the techniques applied), topology (dynamic changes in shape), routing, mobility (movement of the devices) and delay (packet drop due to low power or bandwidth) to mention but a few. Many attempts have been made to tackle these problems, however, many are yet to be solved. These attempts include the use of different technologies and developing strong algorithms, as well as many untested hypotheses.

The basic assumption made in this research work is the employment of narrowband frequency techniques in the communications model, which is believed to be the nerve centre of most problems associated with MANETs. Therefore, it is our belief, that introducing a full wideband frequency into the communication system will definitely solve parts of these problems. Due to the complex nature of MANETs (where transmission is based on free space, not the use of physical infrastructure like twisted-pair media, coaxial cable or optical fibre), information carrying capacity should be maximised to overcome the above-mentioned challenges. At the moment, the most recent wideband technology used in communication and networks, imaging and indoor geo-location tracking is Ultra WideBand (UWB).

Currently, UWB in our contemporary, wireless world plays a vital role in providing more capabilities of low power consumption with high data rate at the same time, transmitting with large bandwidth. Communication in MANET between devices uses short-range transmission and reception. In this respect, the use of UWB provides greater support, and in turn, greater advantage. Although distance between devices constitutes issues in MANET, UWB has the ability to measure and overcome distance between devices with accuracy.

Integrating wideband technology in MANET cannot entirely solve the problems in the communication system because of its complexity, which is due to dynamic topology, mobility and other unique identities. Going by the structural view of the network, the system is basically divided into phases which are referred to as the Open System Interconnect (OSI) model. The model constitutes seven layers from 'Physical' to 'Application' when presented from bottom to top. It is probable that, at every layer of the network, different issues arise which can be dealt with in different ways. According to [2], the current technical challenges of MANETs are Medium Access Control (MAC), Routing, Multicasting and Security. It is widely agreed that multiple access, overhead reduction, resource allocation and quality of service are the current methodologies adopted for optimising the performance of present wireless networks [3]. To a

great extent, success in these issues can be achieved at the second layer of the network by optimising the transmission protocol which is the Medium Access Control (MAC) [4]. Therefore, MAC has been identified as the major concern in this research study. The problem of the MAC protocol has led the researchers into the proposition of either designing or optimising a new MAC protocol for MANET.

The development and implementation of the protocol were made using a step-by-step approach from analysis to experimentation and testing. A model was developed and tested analytically and proven with some justified numerical values. Matrix Laboratory (MATLAB) is also used in testing the viability of mathematical expressions and network connectivity between devices. Ultimately, Network Simulator3 (NS3) is used as an environment for testing the new protocol and the results indicate that the new protocol performs better compared to existing protocols.

1.1 Statement of the Problem

Wireless mobile ad hoc networks have many inherent problems as stated in the introduction section, making them absolutely different from wired networks because of their unpredictable behaviours. These problems are mobility, limited power resources, topology and other hidden issues between each and every layer of the network. Apparently, Medium Access Control (MAC) protocols for wireless MANET should be characterised by additional properties, in order to support the existence of the network in terms of power conservation, multiple access, quality of service, resource allocation and overhead reduction.

Many have designed MAC protocols for MANET with different techniques and approaches but with limited consideration of using Ultra WideBand (UWB) systems. In spite of such limited consideration, the utilisation of the properties of UWB have not been maximised in terms of implementation. Current MAC protocols, either distributed or centralised, aim to define rules for consistent access of the shared medium, in terms of fairness and efficiency, and

to avoid total collision in the medium. However, to some extent, they ignore some of the MAC issues which include overhead reduction and high-power consumption.

As discussed earlier, the challenging issue is to design a new MAC protocol for UWB MANET with less power consumption which will also offer a high data rate with full consideration of using directional antennas.

1.2 Research Motivation

Having looked into relevant literature, it is easy to realise that the most challenging issue is the high consumption of energy by the mobile devices in MANETs [5-7]. MANET is one of the emergent fields in the wireless community with enormous challenges, especially in the aspect of applications. This can be utilised in different ways at different levels, especially in emergency situations. These challenges include: quality of service, energy and routing which is the current challenges in the field[8]. Therefore, this research is motivated towards conserving energy in MANET by applying UWB technology for low power and high data rate transmission. The application of UWB technology will be specific to the transmission protocol which is the Medium Access Control (MAC) and also, to utilising the properties of directivity (directional antennas).

1.3 Research Aim and Objectives

1.3.1 Aim

This research is aimed at designing an improved MAC protocol for UWB systems in order to minimize power consumption in MANETs.

1.3.2 Objectives

The objectives of this research study are as follows:

1. To develop an extensive review of features and in-depth challenges of mobile ad hoc networks, with a clear description of MAC protocol for UWB transmission concepts in MANET.
2. To outline the key design parameters for the implementation of the UWB MAC in MANET.
3. To analyse the proposed model using numerical values to test the new MAC protocol for energy efficiency and having high data rate UWB MANET.
4. To develop a simulation testbed for the effective implementation of the developed protocol and validate the proposed MAC protocol.

1.4 Research Methodology

This section highlights the steps for solving the problem using existing strategies. The adopted approach is within the context of the research hypothesis which states that:

‘The unique characteristics of high-speed UWB transmission systems can be used to design and develop a MAC protocol which is optimised in terms of minimising power consumption.’

The steps for successful implementation of the methodology as stated by [9] are:

Meanwhile, in the research study, experimental quantitative research methodology is adopted and therefore, data is generated based on the hypothesis and experimental tests. It is the model primarily used and analysed by positivist researchers as specified in Figure 1.1.

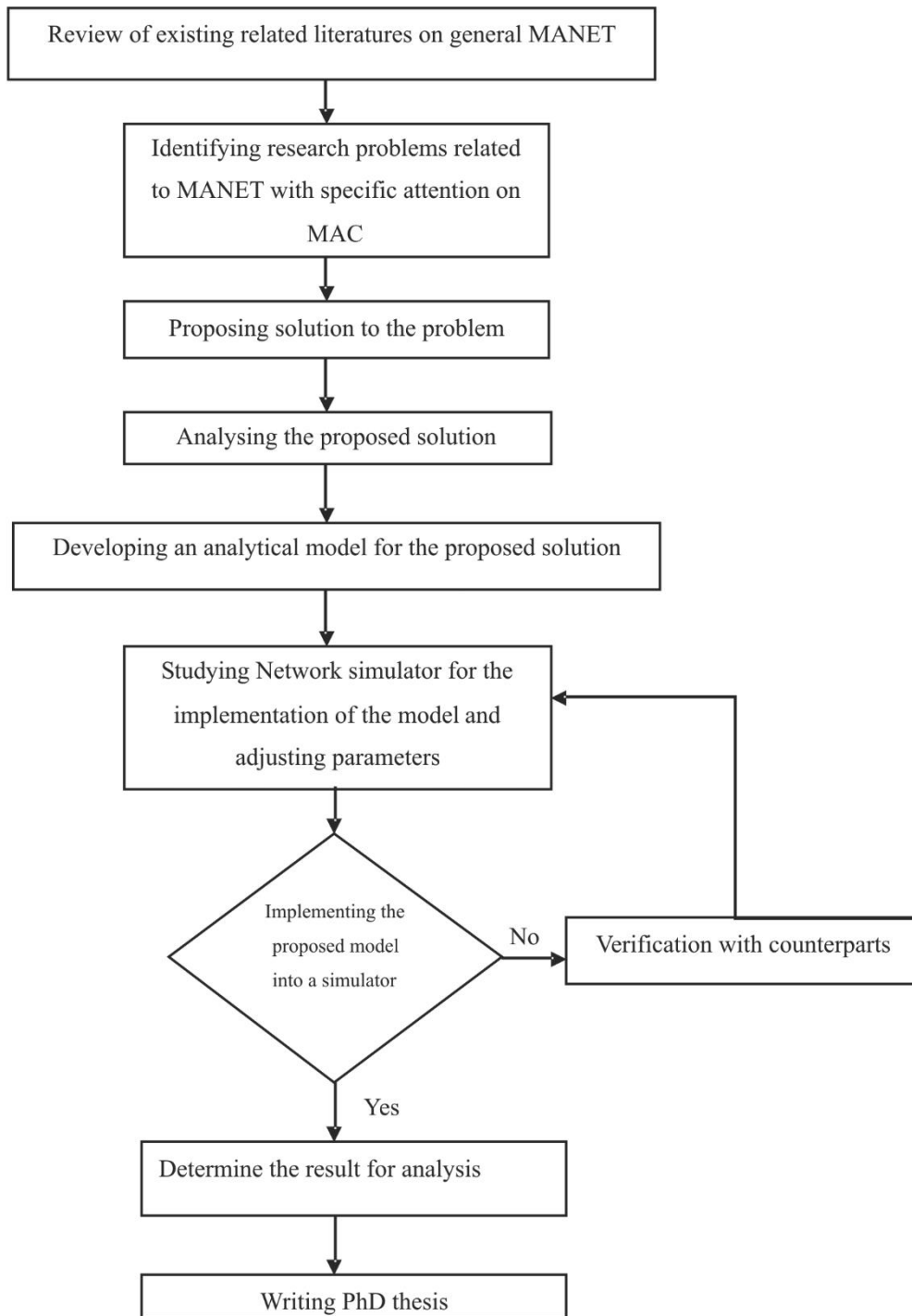

Figure 0.1: Process flow Diagram

The figure above is the summary of the processes of implementing the research, that is, the methodology based on the drawn hypothesis. The process can be achieved as listed below from related literature up to writing the final thesis. Below is the description of the flow diagram and all the counter parts.

i. Literature Review on MANET

To undertake a comprehensive study of MANET, including the application of strategies and to acquire in-depth knowledge of the networks, various previous works on MANETs and the potential for improving performance were reviewed. In addition, the existing UWB-MAC protocols with specific consideration of power saving techniques were reviewed in order to understand the limitations of current MAC protocols that have been addressed in UWB-MANET. Furthermore, it will help in providing specific design features and parameters to be used in solving the problem.

ii. Research Problem

Based on the literature search conducted so far, it is evident that the existing problems of MANET are still enormous. Table 1 outlines the existing challenges of MANET. After conducting a thorough literature search, it is clearly understood that not much work has been focused on MAC protocols, especially with regards to power saving. In view of this, this research focuses on designing an optimal MAC protocol for low power UWB devices that also offers high data rate. The contribution of this research will be on improving the performance of MANET by developing a strong MAC protocol with directional antenna that has features of UWB technology.

iii. Propose Solutions

As the problem has been identified therefore, UWB-MAC protocols will be developed and evaluated in order to address the problem which will serve as the solution to the problem. As stated earlier while defining the parameters to be used, the proposed protocol will combine the features of existing protocols for normalisation and also, utilise UWB's unique features in order to achieve the desired goal.

iv. Analyse the Proposed MAC Protocol

The proposed MAC protocol features will be based on the characteristics listed in Table 4. The design of the proposed MAC protocol will be based on IEEE 802.15.3 architecture. There will be greater consideration of power management and other design parameters and directional antenna systems, in order to improve the protocol standard and boost the performance of MANET such that good quality of service will be maintained.

v. Develop an Analytical Model for the Proposed Protocol

Here the design of a prototype of the proposed MAC that will demonstrate the metrics to be used for implementation has been considered. The metrics will describe the input/output, process flow and their connections. The prototype will represent the entire system before implementation.

vi. Study Network Simulation Software that would be useful to apply in MANETs

The simulator to be used for the implementation of the research study is QualNet and Network Simulator3 (NS3) because of their robustness compared to other network simulators. Both QualNet and NS3 have almost all libraries for different network layers and sub-layers. A brief review on the capabilities of QualNet and NS3 is provided in chapter two.

vii. Implementing the Prototype into a Real Simulation Environment

The designed prototype will be implemented in a simulated environment (QualNet simulator and NS3) in order to test the proposed protocol. Different scenarios will be

created based on the defined parameters in order to obtain different results for analysis and to propose future work.

viii. *Determine the Results*

The analysis conducted, based on the implementation made, will be determined and recorded such that the result can be tested. The result will eventually be analysed thoroughly in order to detect problems and errors for modification with the hope of getting optimum results as expected.

ix. *Verification with Counterparts*

If errors are detected based on the evaluated data and result, then modifications or improvements are made to the implementation stage. The modified result is re-tested within the same simulation environment for perfection. If the outcome of the modified result is perfect then, an analytical model is used to test whether the results coincide with the real system. If not, re-modification has to be done again until acceptable results are achieved.

x. *Writing the PhD Thesis*

This marks the final part of the research study, as all the stages are compiled to form a single thesis for submission. Theories obtained from background studies, literature reviews, methods used, data analysis and a conclusion are all combined in order to complete the PhD thesis. Future directions and possible upgrades to the work done are also suggested.

1.5 Thesis Organisation

This report covers a detailed study on enhancing the energy efficiency of Ultra WideBand (UWB) based in Mobile Ad hoc Networks (MANETs) by developing a standard MAC protocol that optimises the performance of MANETs. The report is organised as follows:

- The first chapter gives a general overview of the research study by stating the problem, research motivation, research question, research aim, and objectives. Furthermore, in this chapter, the research methodology adopted, as well as the anticipated contribution to knowledge, have all been presented.
- Chapter two highlights the general background on MANETs, existing MAC protocols and UWB technology. Historical reviews, applications, characteristics and the general architecture of the basic ideas were discussed in this chapter. The idea of selecting the protocol of our study and some justified parameters for implementation has been presented.
- Chapter three presents the literature review on the general concept of MANET and UWB technology, MANETs' in-depth challenges and applications, UWB applications and the standard review on existing MAC protocols for MANET. The chapter also highlights the general overview of using directional antennas in MANET and considers how other studies achieved the use of directional antennas in different perspectives. A summary of the review is presented which encapsulates the entire chapter. The methodology was adopted from the related literature on how to develop the new UWB-MAC for MANET. Finally, the presentation of a preliminary test of the proposed protocol using QualNet Simulator. The analysis determined the performance evaluation of the proposed protocol against the existing protocol. A summary of analysis is presented at the end to figure out the key design parameters for the next chapter.

- Chapter four highlights the key design parameters, constraints of using directional antennas, model modification, network size to be considered, traffic analysis and finally, the analytical model of the proposed UWB MAC protocol. The chapter also presented some generic results of the modified protocol using QualNet Simulator. These results represent the performance of the modified protocol with respect to the number of packet drops, total energy consumed, percentage of time in transmission and total throughput. The chapter also presents the expansion and results of the analytical model using some justified numerical data which also validates the modified MAC protocol. These results are presented based on total power consumed in the network with respect to change in different parameters (distance, propagation, CBR and density of the network).
- Chapter five presents the proposed protocol framework, implementation and algorithm. The proposed framework also presents the conceptual distinctions and how the idea is organised based on the computer networks' standard, with a detailed explanation of each and every stack of the communication process. In the implementation section, the implementation of the design concept with a detailed explanation of the concept formulation is highlighted. The algorithm and state-based model for power saving is presented, with concluding remarks which summarise the outcome of the implementation procedures.
- Chapter six is the simulation model to assess the analytical evaluations and results of the proposed model with respect to some matrices using NS3. The results show that the proposed model performs better than existing models.

Finally, chapter seven presents the summary, conclusion, recommendations, constraints encountered during the research study and suggestions for future work.

Chapter Two

2.1 Background Study

This chapter explains the general background of the research study starting with extensive details of ad hoc networks (MANETs), wireless mobile ad hoc networks, their generation and MANET network design. An explanation of Ultra WideBand (UWB) systems is also provided which comprises its meaning, history, types and the application of UWB in MANET. The chapter also discusses what Medium Access Control (MAC) means, its frame, its types, MAC protocols for MANETs and the basic highlights of IEEE 802.15.3 as a protocol under test. Finally, the chapter explains power conservation and energy saving models.

2.2 Ad hoc Networks

An ad hoc network is a special type of network, designed for a specific purpose, in which the devices are interconnected and communicate without any assistance from a central device. These devices are connected spontaneously and communicate by forwarding packets directly to each other without the support of a base station. The ad hoc network is an independent system which does not rely on any pre-existing infrastructure like a Service Set Identifier (SSID) or a router to manage communication between the devices. An ad hoc network establishes single session connections that are set up for limited periods and all its protocols are self-configuring to support its environment, mission and traffic changes. As ad hoc networks are specialised networks, so also are the applications running in the networks. These applications are tuned to suit particular applications like video conferencing and video streaming in a specialised field. The applications of an ad hoc network are unique because of its design requirements. These design requirements include self-configuration, mobility, dynamic topology and multicasting. Most of its applications rely on the existing circumstance that leads to the establishment of the

network. Examples can be found in medical responses to tragedy, crime responses to insurgency and fire outbreaks. All these can be established and maintained for both data and real time traffic.

2.3 Wireless Mobile Ad hoc Networks

Networks in general terms were initiated from the physical interconnection of devices using a wired connection with cables from two devices and more. The connection is from peer-to-peer to multiple connections of devices for the purpose of sharing resources. The advancement in radio technology, which began the transformation of the network into the wireless system in the 1970s, contributed to the development of mobile communication systems. The potentiality of wireless mobile ad hoc networks in recent years motivates many to use it in so many areas. The variety of applications supported by WMANET cannot be overemphasised. WMANETs provide secure user access with regards to information and communication technology because of their unique nature in terms of supporting efficient communication between only two devices. Wireless MANETs support single and multi-hop path communication formed in a peer-to-peer fashion. Devices in wireless MANETs are multi-fashion devices that can serve as both hosts and the routers that provide the links between them. Due to its dynamic nature, routing occurs by addition and deletion of devices in the network and the topology also varies dynamically. Figure 2.1 shows an example of wireless MANETs with their full attributes (nodes, single range and wireless link).



Figure 0.1: Wireless Mobile Ad hoc Network [17]

The main advantages of implementing WMANET is the absence of aiding devices, the collaborative nature of the network (deployment in a small area) and the flexibility of implementation, such as buildings, conferences, workshops and organisations. Another important advantage is its swift implementation in the battlefield and disaster recovery areas. Wireless MANETs have more complexity concerning implementation when compared to a wired network in terms of their broadcast medium, topology, signal strength, propagation, bandwidth availability and processing power.

WMANETs are divided into three main categories: WMANETs in communication used in vehicles and side equipment are called Vehicular Ad hoc Networks (VANETs), WMANETs used to link mobile devices and other internet gateways are called Internet Based Mobile Ad hoc Networks (iMANETs) and finally, WMANETs used in vehicles as intelligent agents to detect unnecessary accidents are called Intelligent Vehicular Ad hoc Networks (InVANETs).

The applications of WMANETs are numerous, such as in Personal Area Networks, Sensor Networks, Disaster Area Networks and Military Battlefields. They can also be applied in the organisation of various mobile devices to communicate without third party intervention. They can also be used in emergency rescue operations in disaster recovery. MANETs can be used to

detect some properties in an area using sensor techniques. With regards to the applications of the network, WMANETs have some renowned limitations which include security, energy constraints, bandwidth constraints, high latency, transmission errors and processing capability.

2.4 Generations of Wireless Mobile Ad hoc Network

WMANET generations can be categorised into first, second and third generations. These generations differ with regards to their features, design challenges and year of implementation or existence.

2.4.1 First Generation Wireless MANETs

The first generation of WMANETs was developed in 1972 by the Defence Advanced Research Project Agency (DARPA) as reported by [10]. This network was initiated using a Packet Radio Network (PRNET) with limited features. The first generation WMANET was developed specifically by military personnel to carry out military activities to ease communication between divisions. DARPA initiated this project to explore the feasibility of using Packet-Switched radio to test how reliable communication takes place using wireless devices. The study was designed to last for fourteen years, that is from 1973 to 1987, to assess the robustness and reliability of the system through tested experimental study. The project was defined according to network standard specifications and guidelines regarding device specifications, protocols and automated distributed systems.

Communication acquired in first generation WMANETs was through the use of firmware components which can be loaded locally through Packet Radio in conjunction with Serial Interface. The Packet Radio collects information through the firmware about each and every device participating in the network by stating its basic nodal capacity, routing information and nodal capacity for monitoring and debugging purposes. First generation WMANETs used Radio Frequencies (RF) technology for data/packet transmission/reception at 400Kbit/s and

100Kbit/s rate. These transmissions and receptions occurred using omni-directional, spread spectrum and half-duplex transmission. The group achieved only the three core layers of the OSI model which are the physical, data link and network layers and the future generations built on the remaining layers with some perfections.

In summary, first generation MANETs used radio frequency to send and receive data and these were called Packet Radio networks which were developed by DARPA.

2.4.2 Second Generation Wireless MANETs

The second generation WMANETs came in between the early 1980s and mid-1990s with the same approach as that of the first generation WMANETs and this was also as a result of aiding combat operations. The implementation was rather more advanced when compared to the first-generation ad hoc networks. They also introduced the concept of the Global Mobile Information System and Near Term Digital Radio (NTDR) which was commercialised into the global market. These implementations include Bluetooth Technology, Vehicular MANETs, some advanced sensor networks and the like.

The principal aim of second generation WMANETs was to reduce the physical infrastructure identity of devices to make them small, cheap and power-thrifty with more scalability of algorithms. With the aim of achieving resilience to electronic attacks from other ends, second generation WMANETs tended to provide a first-class environment for the defence group with user-friendly and easy access service for the end users. Moreover, the network is self-organising and self-healing and supports multi-hop routing algorithms and Asynchronous Transfer Mode (ATM). This generation has a tremendous advantage over the first generation with regards to geo-routing and wide-area information systems for satellite communications networks and information systems for rapid deployment of forces respectively. In summary, second generation wireless MANETs were self-organising, self-healing and were automatic

radio network management systems. This was known as a Survival Adoptive Radio Network (SURAN) and was developed by Global Mobile Information Systems and Near Term Digital Radio (NTDR).

2.4.3 Third Generation Wireless MANETs

The invention of third generation WMANETs was in the 1990s which also gave birth to the design of mobile computers and viable communication devices that support full radio wave technology. The idea was proposed mainly to support other applications of ad hoc networks for conferencing and primarily, for commercial applications. The most significant use of ad hoc networks is to test the viability of Bluetooth technology and sensor equipment. The first achievement of the group was in 1998, when Bluetooth technology was implemented, using radio wave technology to transmit within the shortest distance. Bluetooth technology supports many users, unlike the previous generations. The achievement led to devices communicating, co-ordinated through a device called a PICONET. The Piconet device serves both as a client and also as a server machine with a coexistence within the same range. The second achievement was the implementation of sensor networks that are applicable in so many areas of business, the military, conferences, disaster areas and so forth. Sensor devices are more intelligent than Bluetooth devices when it comes to communication because they are spread in a geographical area and have a high level of signal processing and transmission. They are highly adaptable. In summary, the third generation wireless network was known as the first commercial ad hoc network system, and it was the first network for multi-hop systems which allow eight different devices to communicate easily. The system was also referred to as the first Bluetooth technology.

2.5 Wireless Mobile Ad hoc Design

Considering the three different generations of MANETs which have been explored and how the generations were implemented and used, the achievements have come through strategic design approaches that led to successful advancement in the field. The design of MANETs incorporates the fundamental architecture of general network structure which is referred to as the Open System Interconnect (OSI) model. As described in the first generation MANETs which led to the achievement of the three primary layers, the remaining design approaches considered the other layers, including protocol and standards, which complete the cycle. With these results in place, many researchers attempted to modify some of the protocols for optimisation and the integration of some features that led to some new technologies in MANETs. These modifications include the re-designing of some of the MANET routing protocols, MANET MAC protocols and relating them to day-to-day technologies.

In designing MANETs, many challenges arise, beginning with the physical to the application layer. Three widespread problems characterise the design challenges: cross-layer interaction, mobility and scaling issues as stated in [11]. The most challenging issue in cross-layer interaction design is to keep all the layers of the network communicating efficiently and collaboratively. However, some of the algorithms designed may not be feasible due to the nature of MANETs in terms of the dynamically changing situation. Mobility is the second challenging issue when designing MANETs and distinguishes MANETs from other networks. The third issue in MANET design is the scaling issue and this constitutes a major problem because of the growing number of nodes in the network. As the number of nodes increases, so too does the complexity, especially when the mobility increases.

2.6 ULTRA WIDWBAND (UWB)

Ultra-WideBand (UWB) systems can be defined as impulse, baseband technology or zero-carrier systems which can operate across a wide range of frequency spectra and can also be related to the centre frequency. Ultra-WideBand can also be described as a signal which can emit a series of the low-power derivative of Gaussian pulses. In another way, the UWB system can be referred to as a fractional bandwidth of a system that is greater than 25% as defined by the Defence Advanced Research Projects Agency (DARPA) in 1990. This statement can be presented in a mathematical expression as in equation 2.1.

$$B_f = \frac{B}{f_c} = \frac{f_h - f_l}{(f_h - f_c)/2} \quad (2.1)$$

Equation 2.1: UWB Equation

Where B_f is the Fractional Bandwidth, B is the occupied Bandwidth and f_c is the centre frequency of the band. The f_h and f_l are the upper and lower limits respectively.

The UWB system is a technology that provides potentially unlicensed operation which does not require complex standard rules. The process transmits a very low-power emission and is capable of delivering a high data rate of 100Mbit/s. The technology consumes very little battery power in wireless communication devices and occupies a small area of space in terms of physical appearance. The little battery can be describe as a long battery life of portable devices because of its strict power limits. It is a commercialised technology with a low price compared to other technologies. Is a single chip architecture which can be implemented in a small-size on a single chip device, for example, a CMOS technology, silicon-based devices, and standard-based radios. The system is flexible regarding the power spectrum, as it can be adjusted to reduce the level of drainage, specifically in sensitive areas like a Global Positioning System

(GPS). The UWB system is an immune technology that protects wireless devices from multi-path interference in a frequency domain perspective. This can be described as a fading robustness that is capable of resolving multipath components (MPCs) within a dense multipath environment. Therefore, it will help to improve network performance and increase quality of service of the system. The capability of UWB systems concerning the frequency domain improves the performance of the radio frequency which also resolves multi-path interference in a wireless network.

The diagram in Figure 2.2 depicts a UWB system according to the FCC definition with a total bandwidth greater than 500Mhz. The diagram compared different technologies with UWB system in terms of ranging and data rate support for transmission and reception. These technologies includes zigBee, bluethood, WiMax and WiFi. Since the research study is conducted here in the United Kingdom (UK), difining the difference between United State (US) and European Union (EU) is vital in order to spot their difference in terms of restriction and other policies. The differences are in terms of regulatory existence, regulatory regime, frequency range, Outdoor permission, emission profile, EIRP and the use of DW1000 in outdoor and indoee.

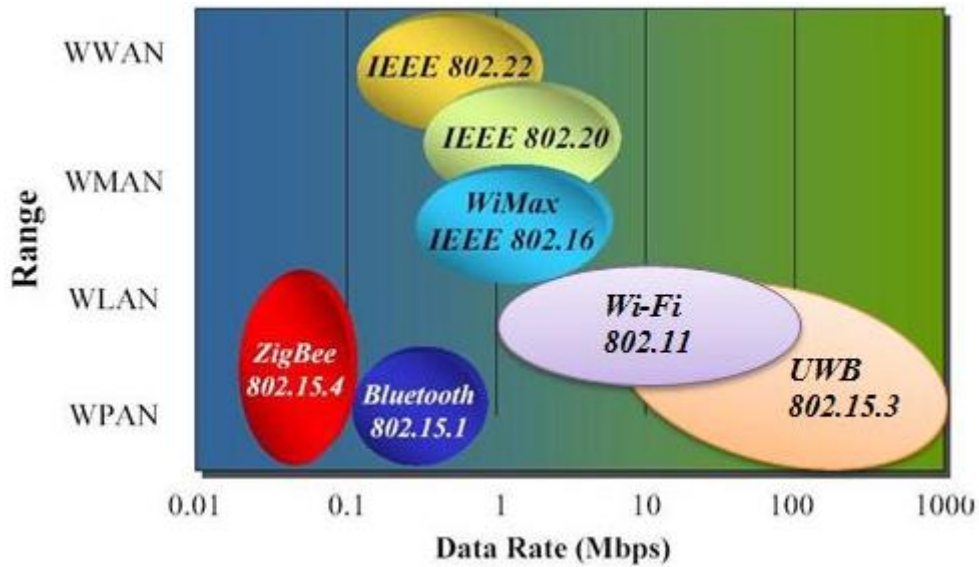

Figure 0.2: FCC UWB comparison with other Systems [20]

The major difference between the two regions are regulatory bodies, frequency range and emission profile. FCC is the regulatory body in US while in the UK are ECC and ETSIEN. The frequency range in UK are 3.1-4.8GHz, 6.0-8.5GHz and 8.5-9.0GHz while in US is 3.1-10.6GHz. The emission profile in UK is ETSI sec5 while in US is FCC sec3 [12].

In summary, UWB is a system that has a spectrum re-use of 3.1-10.6GHz of frequency which co-exists with other users and can transfer a high data rate of 500Mbps at 10 feet in a short range. It has a multi-path immunity with an active path delay greater than the pulse width. It is a low power transmission system with a baseband modulation and no carrier. It is also a low-cost technology with a simple analogue module, yet almost all the devices are digital in nature.

2.7 A Brief History of UWB Technology

The trends with which technology has evolved have been based on key future technologies like location awareness, sensitive sensor devices, broadband communication, ad hoc networks and the like. Consequently, UWB provides one of the primary tools for the implementation of these future technologies in today's wireless communications systems. Different institutions refer to

the UWB signal as a same impulse, orthogonal function, carrier-free, non-sinusoidal, time domain and large-relative-bandwidth radar signal. The Ultra WideBand system has existed a long time but its development began during the 1960s in the transient analysis and time domain measurement by some great researchers like Harmuth, Ross, Robbins, Van Etten and Russian investigators according to [13]. After that, in 1974, a scientist called Morey was able to design a UWB device, often called impulse or carrier-less or baseband or UWB radio system that would penetrate the ground and was commercialised in Geographical Survey Systems. Two years later, different researchers invented another UWB system for fast sampling receivers: Moffat and Puskan [14].

Wideband antennas, pulse train generators, detection receivers, switching pulse train generators and pulse train modulators were the basic components of the Ultra WideBand system, developed for radar or communications systems in the 1970s. After that, most of the innovations related to the UWB system were carried out on the sub-systems but not the entire system. These innovations were just in UWB systems.

A team headed by Col. J.D., twelve years later in 1989, co-ordinated by USAF, had a program in UWB systems to develop an advanced radar system in the former Soviet Union/Russian Federation and China. At that time, ongoing academic programs were instigated in different universities like LLNL, LANL, Polytechnic University Brooklyn and the University of Rochester. The studies focused on the physical transformation of a wireless device like a short pulse signal.

Later on, micro power impulse was invented by T. E. McEwan in 1994 at the LLNL Institute: the first ultra low power system. Although the system was extremely complex and expensive compared to the existing low power systems, it was marked as the first UWB advanced radar

system which operated microwatts of battery drain. From then on, different advancements were made by numerous research agencies within a short interval and have continued till now.

2.8 Types of UWB Systems

We have three types of UWB system [15], and they can be categorised based on the communication, radar and imaging systems. These are:

- i. UWB in communication and measurement systems
- ii. UWB in imaging systems
- iii. UWB in vehicular radar systems

UWB in communication and measurements is the primary focus of this study. The study aims to use the features of the UWB system to increase the capacity of bandwidth and adaptive selection of the frequency band in MANETs at the MAC layer to conserve energy. The frequency operates from 3.1 to 10.6GHz with a bit rate of 100Mbps or greater within a short distance of 10 meters radius in a wireless personal area network. The high frequency and high data rate will not affect the robustness, low power dissipation and low power transmission. Rather, it is an essential characteristic of the system.

UWB in imaging systems encourages robust detection of locations and objects that are invisible or hard to penetrate [16]. Examples are objects enclosed by a wall, movement of people, objects behind the wall, health equipment, ship plantation, mining equipment and the like. Modern video/audio recording devices are fortified with UWB features for better service and better output. Organisations use it because of the lower cost, the portability and the few implementation constraints[17].

UWB in a radar system is a type of UWB system that is meant to control near collisions in communication. The system was designed to avoid near collisions and can operate at a frequency of 22GHz and 29GHz band [18].

2.9 How UWB Works

The UWB system is a digital form of signal that spreads over a wide band using techniques called Frequency-Hopping Spread Spectrum (FHSS) or Direct Sequence Spread Spectrum (DSSS). This is a signal spectrum that uses short analogue pulses for signalling which does not physically rely on traditional modulation techniques. This is also referred to as impulse modulation.

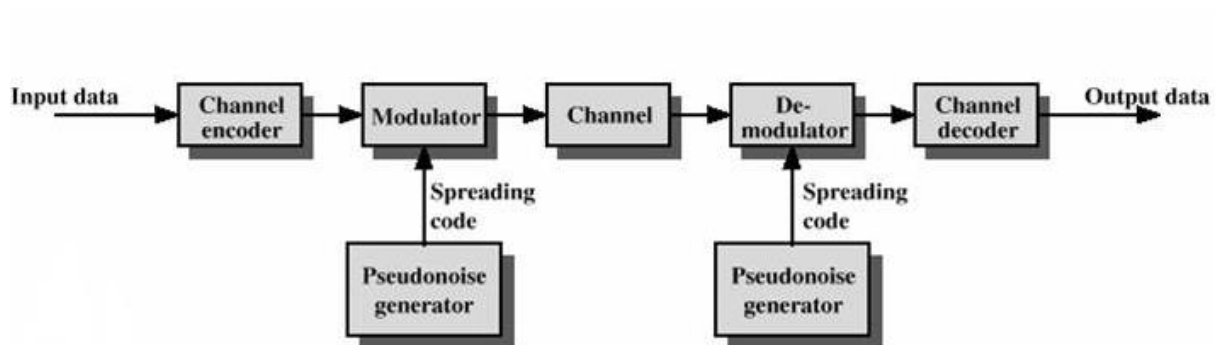

Figure 0.3: FHSS Transmitter and Receiver Diagram

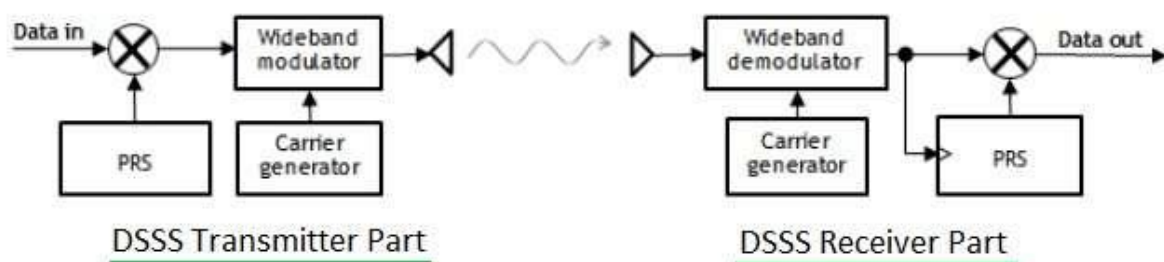

Figure 0.4: DSS Diagram Transmitter and Receiver Diagram

The Direct-Sequence UWB (DS-UWB) transmits pulses nanoseconds long which spread the signal over a very broad frequency band that is at least 500MHz wide. In another method, as

in the case of Orthogonal Frequency Division Multiplexing (OFDM) (which is also referred to as non-impulse modulation) the frequency band is divided into five groups which contain no less than 14 frequency bands in total. Figure 2.6 presents the DS-UWB transmission plot with an amplitude and background noise. Table 2.1 shows the OFDM operational band group with Band ID and centre frequency.

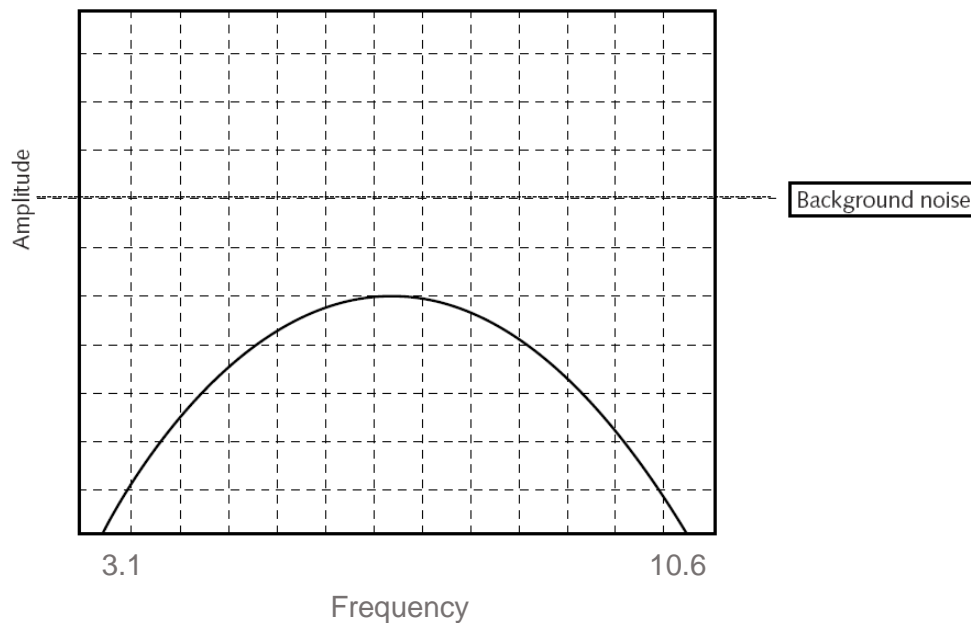

Figure 0.5: The DS-UWB Transmission Plot

The major differences between FHSS and DSSS are that DSSS is mainly for point-to-point connection while FHSS supports point-to-multipoint connection and performs excellently in that capacity compared to DSSS. Concerning sensitivity with regards to durability, DSSS is sensitive and eligible for only sensitive applications while FHSS is robust technology which is durable in all circumstances. However, DSSS performs better regarding data delivery than FHSS which delivers up to 11Mbps while FHSS delivers a maximum of 3Mbps per transmission.

Table 0.1: OFDM operational band group with Band ID and Centre Frequency

Band Group	Band ID	Centre Frequency (MHz)
1	1	3,432
	2	3,960
	3	4,488
2	4	5,016
	5	5,544
	6	6,072
3	7	6,600
	8	7,128
	9	7,656
4	10	8,184
	11	8,712
	12	9,240
5	13	9,768
	14	10,296

In OFDM mode, each frequency band is allocated with a 528MHz frequency wide range and the channel type is orthogonal which means they cannot interfere with each other. The data bits in each frequency are sent simultaneously in a parallel fashion.

UWB also works using Biphase modulation which is the most common modulation technique after FHSS and DSSS. Biphase modulation is a technique that uses a half-cycle current analogue pulse to represent a 1 in the communication medium.

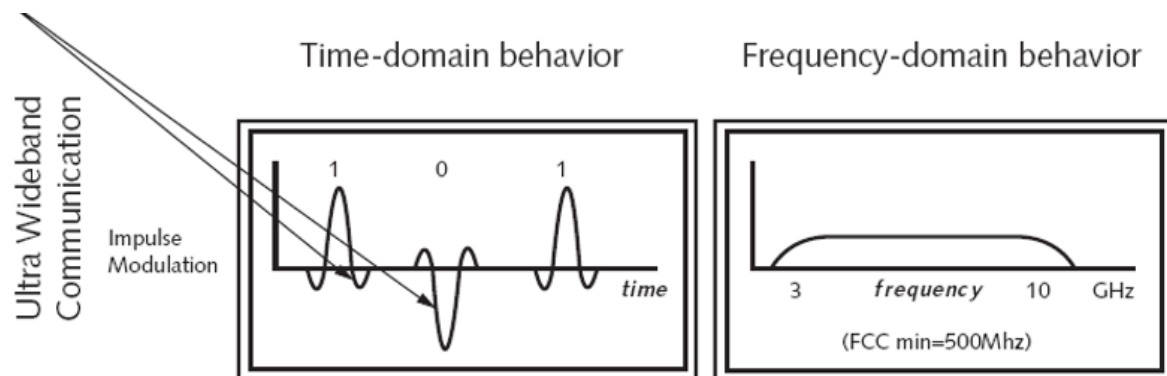

Figure 0.6: Biphase Impulse Modulation

2.10 Applications of UWB systems

According to the Wireless World Research Forum (WWRF), studies have revealed that in recent years, for any organisation that is willing to enhance the potentiality of wireless devices, especially beyond third generation (3G) networks, it must consider the inclusion of UWB technology [19]. The WWRF will come up with a suitable technique for exploring the use of UWB technology in the development of future wireless devices. In MANETs, transmission of information is based on short range communication which results in several issues like packet drop rate, low QoS, delay and high energy consumption by mobile devices. However, integrating UWB MAC in MANETs will boost the communication channel to overcome these problems. Topology is one of the problems highlighted in Figure 2, due to the unspecified arrangement of mobile nodes. Hence, locating devices in such an environment will become an issue. Subsequently, UWB technology will help in providing easy location tracking in the network.

UWB technology is widely used in medical environments, particularly for bio-embedded chips designed for detection and tracking systems. It is also used severally as a transformative technology for high-data and low-power wireless biomedical applications [20]. According to [20] UWB technology can be used in designing pulse generators/transmitters and powerful antennas. Thus, in wireless devices, antennas are the paramount components to consider when describing the properties of a device. The transmission of signals with UWB antennas produces minimum distortion by keeping the pulse shape and the amplitude of the signal in the time and frequency domain [20]. Figure 2.8 summarises the application of UWB systems according to layers of the OSI model.

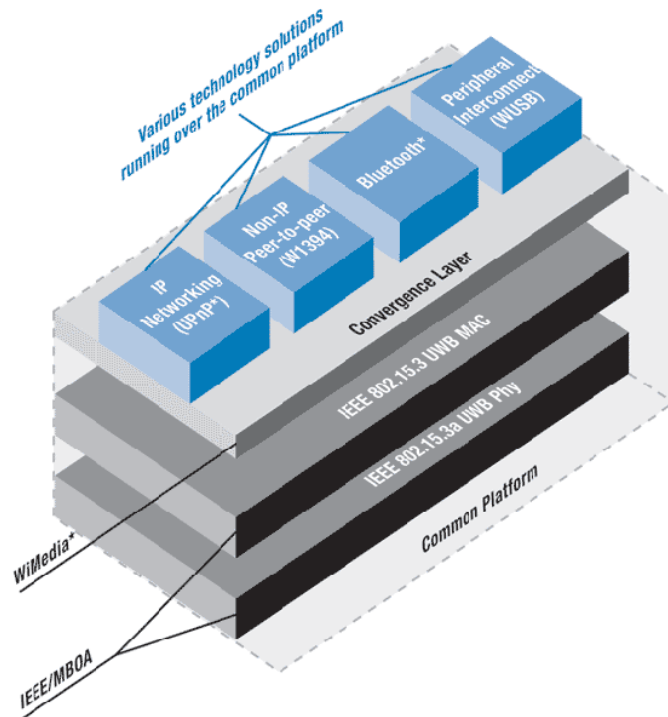

Figure 0.7: Application of UWB systems according layers of the OSI Model

The use of UWB technology in the process of localisation in MANET for tracking due to the decentralisation and mobility of the nodes, will also help to overcome the issue of energy constraint because it will facilitate node discovery and co-operation [21]. Tracking down high-power consumption by mobile devices has to do with the core layers of OSI from PHY to an application in which UWB will support all the layers with minimum technical issues if implemented accordingly. Current research has revealed that no technology surpasses UWB in the provision of broad bandwidth, low power consumption and localisation [21]. Localisation is a factor that diminishes the performance of mobile devices in a network, especially when there is high propagation in the channel. This therefore leads to a high delay in communication in a multi-path environment. Multi-path communication with high delay creates a distortion of the signal. According to [22], the time-reversal algorithm can be used with UWB to reduce delay in MANETs by influencing the proper frequency and injecting high bandwidth into the channel. UWB can be used to achieve accurate localisation through the

physical layer by reducing Bit Error Rate (BER) and mitigating the multi-user interference (MUI) and Gaussian Noise Interference [23].

In addition, routing is another major issue in MANETs, especially when the nodes are carrying heavy applications. The communication produces low QoS because the routing table is congested. With the integration of UWB however, the routing table is expanded so that the channel is used extensively. The technology has been tested on different MANET routing protocols, majorly in data communication, with some in heavy applications [24]. The implementation of a novel routing strategy by [24] shows that in an on-demand routing environment, the use of UWB technology can actually reduce the routing load and the QoS with end-to-end delay will be satisfactory.

Using impulse UWB technology in a MANET radio network will help to minimise the signal relay time delay and also solve the problem of media multiple access while improving the performance of the system [25]. The use of multiple access techniques, as supported by UWB, will allow simultaneous transmission and code division, which will allow for maximum utilisation of the channel as stated in [25].

2.11 MEDIUM ACCESS CONTROL (MAC) PROTOCOLS

Different scholars define the Medium Access Control (MAC) protocol according to network design, type, applications, performance and mode of operation in the communication medium which can utilise either single or multi-path communication. Dr Baruch, from John Hopkins University, defines MAC protocol as one which outlines rules for mobile stations or nodes for orderly access to the shared medium in fairness and efficiency in sharing. This distribution occurs in two different techniques which are static channelization and dynamic medium access control. A dynamic system of exchange comprises two distinct modes: scheduling and random access.

MAC, as a sub-layer of the data link layer, is a mechanism for controlling and addressing channel access in a network as devices communicate through a medium. The techniques used in MAC design are Time Division Multiple Access (TDMA), Carrier Sense Multiple Access with Collision Avoidance (CSMA/CA), Frequency Division Multiple Access (FDMA) and Code Division Multiple Access (CDMA).

Some scholars define MAC as a protocol that performs activities such as flow control, addressing and framing of packets sent or received by every node in a network that can resolve any potential conflicts between the nodes. It is said that it is a protocol which corrects the initial errors emanating from the physical layer before advancing to the network layer. In general terms, MAC is a protocol that encapsulates payload data through protocol control information (PCI) in a network and appends an integrity checksum for cyclic redundancy check (CRC) before and after transmission/reception.

In sensor networks like MANETs, the MAC protocol is a mechanism that regulates user access to the channel and addresses the problems of hidden nodes for better performance of the system. MAC can be classified based on the application of the protocol. In MANETs, the following six categories should be considered while designing MANETs' MAC as stated in [26]:

- Power efficiency
- Hidden node resolution
- Robustness
- Network architecture
- Collision resolution algorithm
- Multimedia support

Researchers in [27], after surveying different MAC protocols for MANETs designed by various scholars, identified another six different parametric items to be considered for design and implementation of a standard MAC for MANETs. These are:

- Range of transmission
- Topology changing
- Power
- Transmission initiation
- Channel separation and access
- Traffic load and scalability

The general structure of a MAC protocol is that it can either be in infrastructure mode with Basic Service Set (BSS), Distributed System (DS) and Access Point (AP) OR it can be in ad hoc mode with Independent Basic Service Set (IBSS) and Single-hop. MAC is a channel access mechanism with a distributed co-ordinated function (DCF) that transmits data/packets, using either Carrier Sense Multiple Access (CSMA) with an immediate acknowledgement or by using Ready-To-Send (RTS) and Clear-To-Send (CTS) exchange. Others use point co-ordinate function (PCF) that transmits packets using seldom implementation, polled distributed access and a contention-free period (CFP).

In summary, Medium Access Control protocol is a shared medium that is also referred to as a broadcast channel, random access channel or multiple access channel that aids the transmission and reception of data packets.

2.12 MEDIUM ACCESS CONTROL FRAME FORMAT

In a general network form, all MAC frames possess a set of fields that are present in the same order which define the functionality of the protocol. In both wired and wireless networks, the

MAC layer in all stations is capable of validating error free reception for a single frame received from PHY or MAC layer, using the frame check sequence (FCS). However, in most cases, the PHY is responsible for passing frames to the MAC and the frames must pass an individual test with the help of the header check sequence (HCS). The frames in the MAC sub-layer are simply the sequence of fields that are arranged in a specific order.

A MAC protocol frame is very wide when it comes to description, especially when considering extensive networks (Wired and Wireless). For background purposes, it was intended to highlight only wireless MAC frames in the wireless medium. Both in principle and implementation, MAC frames are of four types [28]: beacon frame, data frame, response/acknowledgement frame and the command frame. In each block of a frame, there exists a MAC frame header (MFH), MAC Frame Payload and the tail/footer. The frame header and tail have the same structure. Figure 2.9 presents the general wireless MAC frame structure.

Octets: 2	1	0/2	0/2/8	0/2	0/2/8	Variabl e	2
Frame control	Sequenc e number	Destinatio n PAN identifier	Destinatio n address	Source PAN identifie r	Source addres s	Frame payload	Frame check sequenc e
		Addressing field					
MAC header						MAC payload	MAC footer

Bits: 0-2	3	4	5	6	7-9	10-11	12-13	14-15
Frame type	Security enabled	Frame pending	Ack. Req.	Intra PAN	Reserved	Dest. Addressing mode	Reserved	Source addressing mode

Figure 0.8: General Wireless MAC Frame Structure

2.13 General MAC Frame Format

The beacon frame in a wireless MAC is referred to as a management structure that has all the information regarding the entire network. Information in a beacon frame is transmitted periodically to announce the presence of a wireless device in a network. In an infrastructure based system, beacon frames are sent through the Access Point (AP). However, in a non-infrastructure mode like MANETs, it is normally distributed among the stations in the network.

Figure 2.10 presents the structure of a beacon frame format.

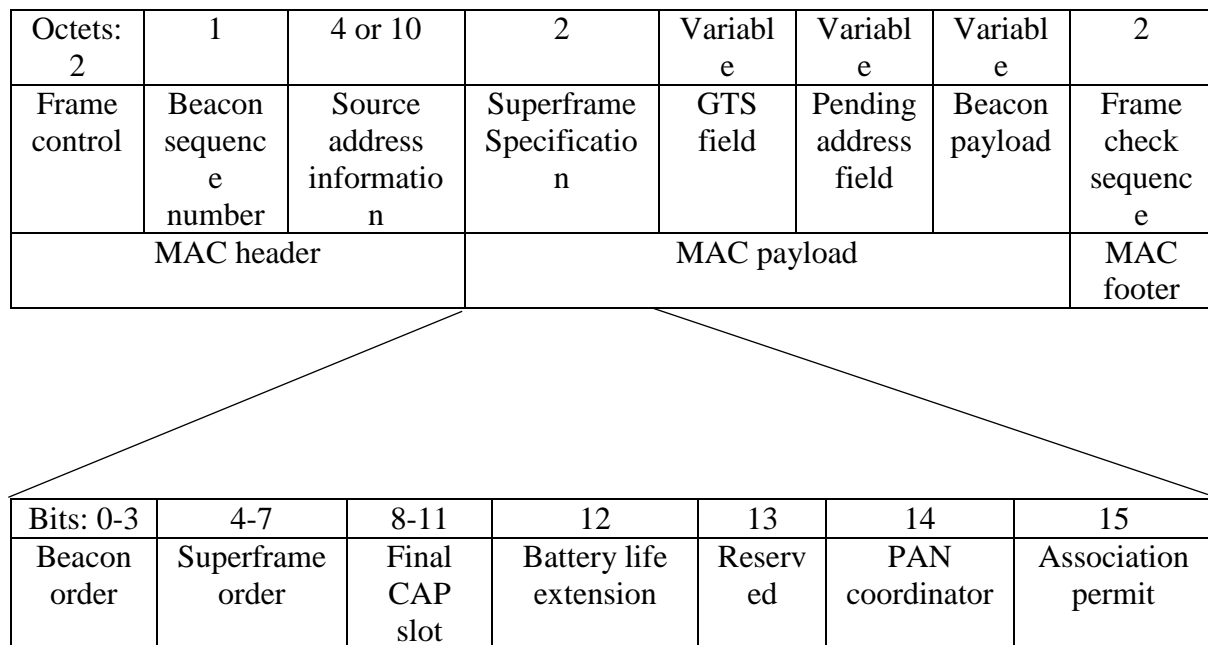

Figure 0.9: Structure of a Beacon Frame Format

2.13.1 MAC Beacon Format

The transmission and reception of command frames in a MAC are done by the Full-Function Device (FFD). This process takes place in the CAP for beacon-enabled PAN and the transmission is indicated by X with the requirement of Reduce-Function Device (RFD). Figure 2.11 presents the structure of the MAC command frame.

2.13.2 MAC Command Frame

Octets:2	1	4 to 20	1	Variable	2
Frame control	Data sequence number	Address information	Command type	Command payload	Frame check sequence
MAC header			MAC payload		MAC footer

Figure 0.10: Structure of MAC Command Frame

Command frame examples are association response, association request, data request, PAN ID conflict notification, Disassociation notification, GTS request, Beacon request, Orphan notification and co-ordination realignment.

2.13.3 Data Frame Format

Data frame is sometimes also referred to as MAC Protocol Data Unit (MPDU), which the general protocol uses to create after receiving MAC Service Data Unit (MSDU). This can be added to the MAC header information from the LLC sub-layer for final transmission or reception. Figure 2.21 presents the details of the data frame format.

Octet:2	1	4-20	Variable	2
Frame control	Data sequence number	Address information	Data payload	Frame check sequence
MAC header			MAC payload	MAC footer

Figure 0.11: Data Frame Format

2.13.4 Acknowledgement Frame Format

This is the frame sent by a node to confirm the handshake between two communicating devices. For instance, if node A sends a packet to node B, then B will send an acknowledgement frame to confirm that the packet has been received successfully. If not, then A will retransmit the packet for a number of periods. Most MACs use these techniques for the successful

transmission and reception of information from one node to another. Figure 2.13 presents the acknowledgement frame format.

Octets: 2	1	2
Frame control	Data sequence number	Frame check sequence
MAC header		MAC footer

Figure 0.12: Acknowledgement Frame Format

2.13.5 Types of MAC Protocols

In this section, the focus will only be on sensor MAC protocols because of the broadness of the protocol. Medium Access Control (MAC) is mainly classified into two main groups and also according to different approaches used in managing the protocol: contention based and schedule based MAC protocols [29]. Contention based MAC is distributed like protocols which do not require the central co-ordinating node to support transmission or reception in the medium. There are different contention base MAC protocols that are used in wireless sensor networks, for example, Sensor MAC (S-MAC), Berkeley Media Access control for low-power sensor Networks (B-MAC) and Predictive Wake-UP MAC (PW-MAC) [28].

These MAC protocols operate in different modes, for example, the S-MAC mode of operation is by placing an active node in a state that listens to the medium and has the advantage of a sleeping schedule which drastically reduces energy consumption in the medium. Another advantage of using S-MAC is its easy adaptation to frequent topology changes in the medium and also, it does not require an additional device to aid communication in the medium. Figure 2.13 shows S-MAC in full operation with four participating devices. The major disadvantage of S-MAC is that it lacks the need to maintain synchronisation for the communication to execute properly.

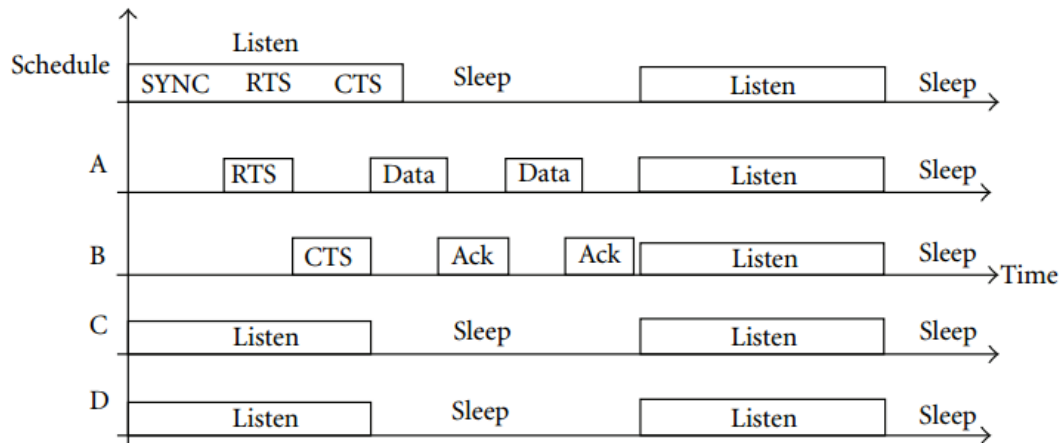

Figure 0.13: S-MAC protocol operation[29]

Other disadvantages of S-MAC include clock drift which sometimes has to do with nodes participating in the medium and normally affects the performance of the medium resulting in nodes becoming unsynchronised. Also, the occurrence of idle listening in the medium affects it, and the control frames used to generate overhead increase energy usage in the medium. In view of these setbacks, the protocol was reviewed and different protocols were developed using the same techniques with improved performance. Examples of these are dynamic sensor MAC (DS-MAC) and timeout MAC (T-MAC). Still more enhancements were suggested and this gave birth to the B-MAC protocol with a different approach that reduced the problems in S-MAC.

The Berkeley Media Access Control for Low-Power Sensor network (B-MAC) is a distributed protocol that was designed to reduce idle listening to save energy usage in many protocols. The protocol uses a back-off time technique which forces the nodes to wait until the channel is clear before sending a packet to the medium. Some refer to the protocol as Low-Power-Listening (LPL) which always checks the channel periodically before sending and receiving data for transmission; this saves much energy in the medium. Figure 2.14 demonstrates how B-MAC operates.

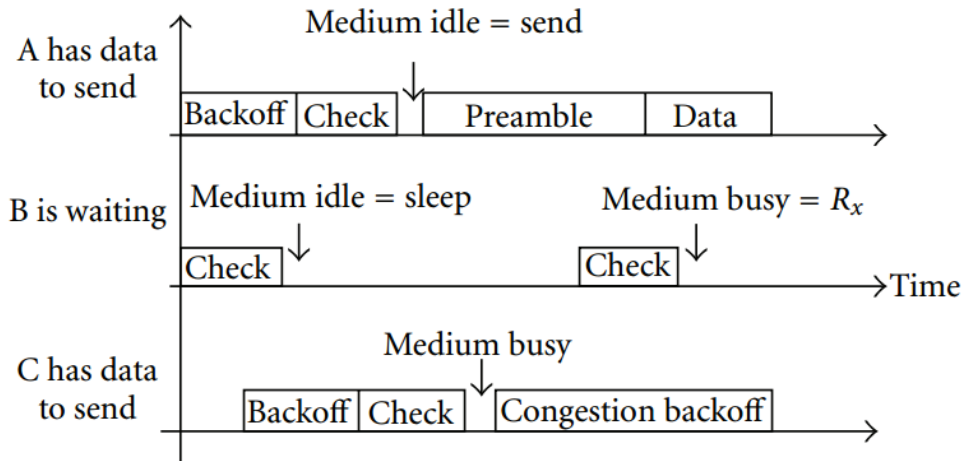

Figure 0.14: B-MAC operation example[29]

The full operation details of B-MAC protocol are in [29]. Part of the advantage of using the B-MAC protocol is that the protocol is hardware base implemented and it does not require RTS, CTS, ACK or a control frame to support processes in the medium. Also, the protocol does not require synchronisation but it has easy adaption to higher layer stacks for the support of different applications. The only disadvantage of the protocol is that its preamble creates a large overhead which affects the protocol performance. For example, it uses a preamble of 271 bytes to send 36 bytes of data to a channel [29].

The final protocol under contention based MAC is Predictive Wake-Up MAC (PW-MAC) [30]. The protocol is more like a hybrid protocol that combines the features of S-MAC and B-MAC because it uses pseudo-random schedules which allow many to transmit at the same time while still avoiding a collision in the medium. The detailed operations of the protocol are contained in [30] and also some limitations of the protocol. The major advantages of PW-MAC are that the protocol can be tested and implemented in hardware using MicaZ motes, the memory footprint of the protocol is small and the protocol sleeps until the receiver is up which in turn, reduces the duty life cycle.

The second category of MAC protocols is schedule based MACs which divide the medium into time slots and in an orderly form for stations to transmit, receive or be inactive. The beauty of the protocol is that each node has a specific time for transmission and after that, the node becomes inactive so as to save energy for the rest of the time. Examples of schedule based MACs are Power-Efficient and Delay-Aware MAC (PEDAMACS), Priority-Based MAC (PRIMA) and Low-Energy Adaptive Clustering Hierarchy (LEACH). The operation details of these protocols can be found in [29]. Table 2.2 summarises some of the wireless sensor network MAC protocols based on the name, implementation strategy, application, synchronisation requirement and overhead.

Table 0.2: Summary of wireless sensor networks MAC protocols

MAC	Implementation process	Application support	Synchronisation requirement	Overhead
S-MAC[31]	Hardware	Event-driven, long idle periods, delay order of message time	Loose	RTS, CTS, ACK, SYNC
B-MAC[32]	Simulation/hardware	Delay tolerant	None	Preamble
PW-MAC[33]	Hardware	Low delay, long idle periods	None	Beacon
LEACH[34]	Simulation	Periodic data collection and monitoring	Tight	ADV, join-Req, schedule
PEDAMAC[35]	Simulation	Delay bounded	Tight	RTS,CTS,ACK, Synchronisation, Topology learning
PRIMA[36]	Simulation	Different QoS	Tight	Synchronisation, Schedule, CH election
IEEE 802.11[36]	Simulation/hardware	High data rates, large energy source, smart terminals	None	RTS, CTS, ACK
IEEE 802.15.1[37]	Simulation	Medium to low data rate, low energy consumption	Tight	Synchronisation transmission, S,C
IEEE 802.15.3	Simulation	High data rate and low energy consumption	Tight	Synchronisation transmission, S,C
IEEE 802.15.4[37]	Simulation/hardware	Medium to low data rate, low energy consumption	Tight	Beacon, Ack
WirelessHART [38]	Simulation/hardware	Process automation	Tight	Synchronisation, Schedule, routing
ISA100a[39]	Simulation/hardware	Process automation	Tight	Synchronisation, Schedule, routing

2.14 MAC Protocols for MANET

WMANETs have unique Medium Access Control Protocols, different from general standards of MAC, that work in either wired networks or other systems. Due to the limitations surrounding these networks, as stated in the MANET introduction section, the MAC in MANETs has to be unique. WMANETs MAC can be categorically classified as either single radio or multiple radio protocols [40]. The single radio protocols were developed with techniques of omni-directional antennas, beamforming and directional antennas specifically at the PHY stack of the network. The multiple radio MACs are more hybrid-like protocols that were developed by combining Time Division Multiplexing Access (TDMA) and Frequency Division Multiplexing (FDMA). The single channel protocol has two sub-branches and four sub-branches respectively. The first two sub-branches are single channel with omni-directional antennas/specialised antennas and multiple channels with Synchronous/Asynchronous types. IEEE802.11 DCF is an example of a single channel MAC for MANETs and research like that in [41] proposed specialised single MACs for MANETs. MMAC, SSCH and TMMAC are examples of synchronous multiple channel MACs, while CAM-MAC, AMCP and AMHP are examples of asynchronous multiple channel MACs for MANETs.

Multiple radio MACs have three branches which constitute one radio for each channel. For example, there is one radio for dedicated control channel/one radio for data transmission and others. Examples of multiple radio MACs for MANETs are DCA, DC-PC, DUCHA and Muqattash. Figure 2.15 shows MANETs' MAC protocols and their sub-categories.

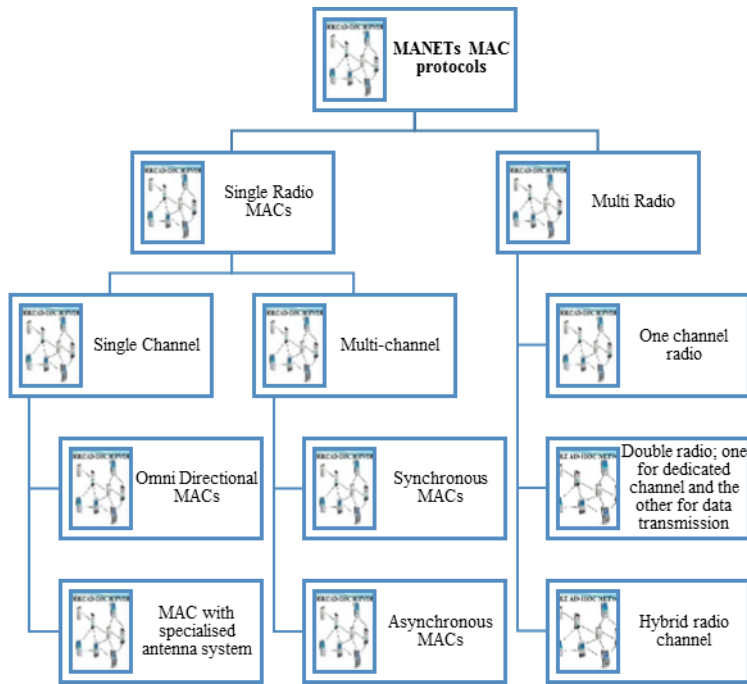

Figure 0.15: MANETs MACs and Sub-categories

2.15 MAC Protocol Analysis

The analysis will be based on the sensor MACs listed above which are contention and schedule based protocols. Table 2.3 summarises the analysis of some MACs based on maximum energy consumed by the protocol, with values and units in line with the focus of the research and the performance metrics used with regards to the implementation strategy, which indicate that either the protocol was implemented in hardware or using simulation. The table also shows analysis of the protocols based on the name of the implemented tool and the maximum latency acquired by each protocol with values and units. Based on the analysis made, it was discovered that most of the contention based MACs were implemented on hardware while the schedule based protocols were implemented only on simulators. Concerning the application support, both types of protocol support and maintain application support but some generate more overheads, depending on the application type and the status of the network. On the performance metrics, the testing of each protocol varies depending on the metrics used to test the

performance of the protocol. Different performance metrics employed different strategies for evaluating the performance of each protocol and its usefulness.

Table 2.3 is based on the analysis of different MAC protocols on total power/energy consume with respect to method of implementation, apparatus used and the total latency for connectivity.

Table 0.3: MACs analysis based on power consumption rate

Protocols	Total power/energy consumed		Method of implementation	Tool name	Total latency	
	Value	Unit			Value	Unit
S-MAC[37]	6	Joules	Hardware	Mica	11	Seconds
S-MAC no sleep	29	Joules	Hardware	Mica	1	Second
B-MAC[36]	15	watts	Hardware	Mica2	1700	Milliseconds
S-MAC[37]	35	watts	Hardware	Mica2	2700	Milliseconds
PW-MAC[42]	10	duty cycle	Hardware	MicaZ	1	Second
WiswMAC[43]	70	duty cycle	Hardware	MicaZ	85	Seconds
RI-MAC[44]	65	duty cycle	Hardware	MicaZ	1	Second
X-MAC[45]	70	duty cycle	Hardware	MicaZ	77	Seconds
PEDAMACS[46]	13	Joules	Simulation	TOSSIM	0.2 X 10 ⁶	Bit time
S-MAC	21	Joules	Simulation	TOSSIM	2.8 X 10 ⁶	Bit time
IEEE802.11	19.5	Joules	Simulation	TOSSIM	0.45 X 10 ⁶	Bit time
PRIMA-RT[47]	0.015	Joules	Simulation	OMNeT++	15	Seconds
Q-MAC-RT[48]	0.024	Joules	Simulation	OMNeT++	5	Seconds
IEEE802.15.3	5	Joules	Simulation	NS3	2	Seconds

For random based networks, where the topology is frequently changing, and based on the application requirement used in the implementation, contention based protocols are ideal for use because there are no major delay constraints and there is no mechanism to ensure tight synchronisation although in some protocols, there is high energy consumption compared to when implemented in schedule based protocols. In another approach, random based networks performed better in terms of energy consumption in schedule based networks because of the support provided by the base station for the networks.

2.16 IEEE 802.15.3 AS A PROTOCOL FOR IMPLEMENTATION

The reason for making the decision to select IEEE802.15.3 as a protocol for modification is the protocol's capability for delivering a high data rate from 55 Mbps up to 480 Mbps as well as the protocol's low power transmission and low cost of implementation in MANETs. It also supports different applications in MANETs easily, like digital imaging and multimedia applications. In considering layer specifications with respect to regarding design structure support, the protocol is designed mainly to support all forms of multimedia applications with high quality of service and it has extreme power management in ad hoc networks. Due to the dynamic setup of MANETs, other MAC protocols do not have the capability of many devices in the network to serve as either master or slave and to join or leave the network conveniently without complications like the IEEE802.15.3 protocol. The protocol has a unique superframe structure as seen in Figure 2.16, which consists of a beacon interval for co-ordinating device movement, a contention access period (CAP) and a guaranteed time slot (GTS). The beauty of the superframe of the protocol is that it has the capability to adjust the boundary between the CAP and GTS which in turn, aids the protocol in saving more energy in the network. Most of the MACs in MANETs suffered when initiating transmission which resulted in high-energy consumption but the selected protocol uses its beacon at the beginning of transmission with specific parameters of the network that include power management techniques and other information for the scalability of the network.

theoretically offer extreme bandwidth for multimedia applications at an affordable price with simplified power consumption metrics, it will be difficult to distinguish the selected from full-fledged 802.11-based wireless LANs. More so, one source of difference is that 802.15.3 is designed to be optimised for PAN distances while WLAN range is larger with scalability.

2.17 Power Conservation

Power conservation in mobile ad hoc networks is a significant factor for consideration in managing the lifetime of devices in the network. To increase power efficiency for battery-driven nodes in the network, a precise resource model has to be developed to handle the early drain of the battery in the devices. The conservation model controls the transmission power and enables low power consumption in the system which, in turn, prolongs the network lifetime. Power conservation models in MANETs is a field of importance and different researchers have proposed and implemented different techniques at the different layers of the OSI model, specifically at the MAC layer. The study has revealed the effects of high-energy consumption on the overall performance of the network by pointing out the impact of using the Ultra WideBand system on performance demands such as overheads, throughputs, delays and latency in ad hoc networks and also the impact of using directional antennas in saving energy in the network. The aim of the study is to contribute to the research trend in the energy efficiency management in a non-aided, ad hoc mobile network and to assist researchers in identifying the best MAC protocols to achieve power reduction design objectives associated with using UWB systems.

The causes of energy waste in MANETs, as specified by [49], specifically at the MAC layer, are idle-listening, collision and control packet overhead and that has been taken care of by other researchers. [49] also highlights that carrier sensing, long headers and the high bit rate are other factors to be considered as forms of power wastage in wireless mobile ad hoc networks. The

study also revealed more power waste factors in the literature for further reading. [50] also added that sensing is another power consumption entity that consumes a significant amount of energy when identifying the status of a node in a network.

To measure the power consumption in MANETs at the MAC layer, the state of every node operating in the network has to be considered when designing the MAC protocol. These are the transmit, receive, idle and sleep mode of the protocol. These factors will determine when the protocol is sending, receiving or at a default state of communication although power consumption in sleep mode is significantly less but in idle state is accountable.

Basically, in WMANETs, devices require two types of power to operate in the network. These are communication-related and non-communication-related power. The communication power is mainly for processing and transmission and these can be further used for executing network algorithms and running network applications respectively.

Akanksha in [51] also summarised six main reasons for managing energy consumption in MANETs specifically at the MAC layer. These include difficulties in replacing batteries, limited energy reserve, selection of optimal transmission power, channel utilisation, lack of central co-ordination and finally, constraints on the battery source. Different methods have been developed by other researchers but the current method for conserving power in a wireless mobile network is focused on the transmission power control which also has different techniques for the PHY and MAC layer. The method also has to do with dynamic turning off of active mobile nodes in the network which reduces energy consumption while sending data and increases the lifetime of the network.

2.18 Power Conservation Models

Models have been developed by researchers for WMANETs to conserve power in the network. Many considered different techniques that involve a different layer of the network that is, from PHY to application stack. In this study, models that are developed specifically at the MAC layer to conserve power in transmission, reception, idle, sleep or a sensing mode were evaluated. The nodes can be in either active or power saving mode. The active mode specifies that either a node is in transmission, reception or sensing and data/packet can be communicated at any given time interval. The power saving mode specifies when a device is either in idle or sleep mode and this allows the channel to check for pending messages periodically. Packet arrival time marks the transition between active and power saving mode.

Some models were formed based on the distance between nodes in the network. The distance between devices is a factor for conserving more energy in relation to the knowledge of neighbour nodes and the distance between them. Therefore, each node in the network requires only the knowledge of its neighbour and the specific distance in-between them.

Subsequent models are based on adjusting transmission power levels in the channel and achieving a high degree of connectivity between devices in the network. The channel uses minimum transmission power for delivering data/packets in the network.

Other researchers have considered the use of cross-layer design to conserve power at the MAC layer by considering either the PHY or network stack of the network. This technique is one of the common models that makes networks more robust and adaptive.

2.19 Directional Antenna for MANET

Antennas, in general, can be described as generic electronic devices that convert electromagnetic radiation within a specified region to electrical currents in conductors or vice-versa [52]. The conversion takes place with respect to the antenna mode that is, either in transmission or reception mode. Antennas come in two, major, distinct categories: omni-directional and directional. The omni-directional antenna simply means that the energy radiates all around the antenna and the actual radiation pattern looks like a day-night shape with two death energy and two radiation patterns. Our main focus in this research study is on directional antenna.

A directional antenna, or a beam antenna, radiates or receives radar power in a specific direction, allowing for increased performance and reduced interference from unwanted sources. Directional antennas provide increased performance of a dipole antenna, or omni-directional antenna, in general, when greater concentration of radiation in a certain direction is desired. A high gain antenna is a directional antenna with a focus of narrow beam width which allows a more precise target of the radio signals. A low gain antenna is a directional antenna with broad radio waves beam width which allow for a signal to propagate reasonably and which is more reliable regardless of any obstruction. Low gain antennas are often used in space as a back-up for omni-directional systems.

The proposed scheme utilises directional antennas and can be used to give a far greater signal that can also be obtained on standard mobile devices. As the gain increases, the beam gets stronger and narrower. We can describe the gain of an antenna in decibels and each time the signal strength doubles, the gain in decibels increases by 3dB. The transmission of directional antennas occurs within a defined angle, typically less than 360° (θ), and it may be used to cover a defined location that captures certain directions. However, by default in MANETs,

transmission and reception are performed through omni-directional capabilities using the three-way handshake technique.

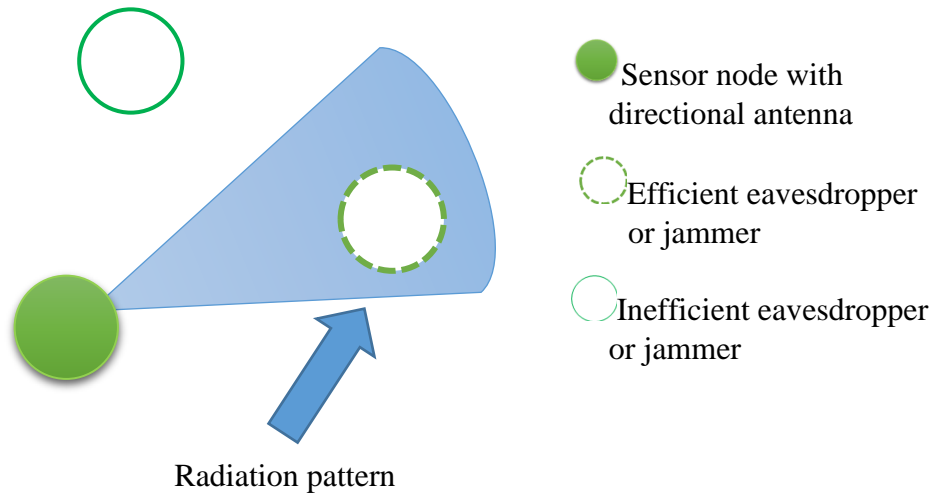
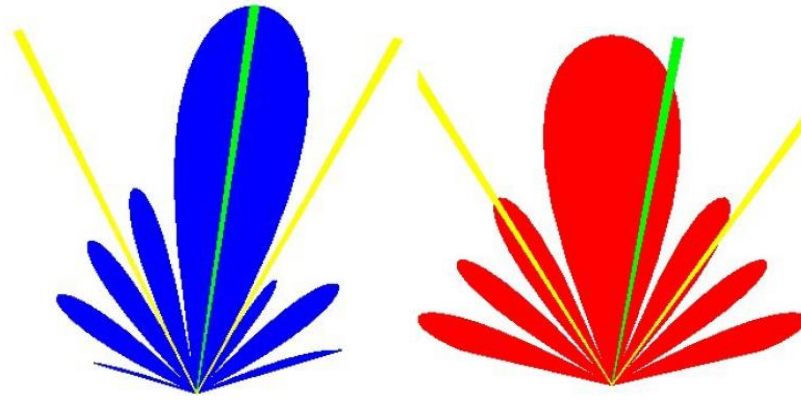

Figure 2.17: Radiation pattern of Directional antenna in MANETs

Figure 2.18 described radiation pattern of a directional antenna system with a sensor node efficiency. The pattern is either efficient or inefficient which the proposed concept proved the efficiency of the model. The transmission varies based on the MAC protocol in place. Some use one acknowledgement (ACK), while others use three ACKs. IEEE 802.11 uses one while IEEE 802.15.3 and others use three ACKs. The suitability of omni-directional transmission in MANETs has to do with selecting suitable downstream neighbours for successful transmission/reception and is more applicable in respect of performance surge when using the directional system to cater for suitable downstream.



a. Steerable Directional Antenna

b. Switch Beam Directional Antenna

Figure 2.18: Directional antenna

Directional antennas are also categorised into three: pattern (adaptive), steerable and switched beam directional antennas as in figure 2.19(a) and (b). The pattern antennas are more of a hybrid system that combines both switched and steerable properties. This study will use steerable instead of switched beam antennas. The disadvantage of using switched beam antennas is the fixed nature of the beam when nodes are transmitting and the focus of the beam is not tilting towards the specific angle of the receiving node. Steerable antennas are more advantageous regarding usage than switched beam antennas because they transmit with a precise angle of direction to a receiving node. They also transmit with minimal interference in the network due to the direct focus of the beam. However, steerable are more cost effect than switched beam which serves as one of its disadvantages. The pattern antennas use adaptive performance in transmitting/receiving signals for the exploitation of spatial dimensions of the channel in the system. Patterned antennas retain three services regarding transmission, reception or both. The services include: Single Input with Multiple Output (SIMO), Multiple Input with Single Output (MISO) and finally, Multiple Input with Multiple Output (MIMO) [53]. The proposed UWB-MAC uses a MIMO transmission form because of its noticeability in implementation.

Several intricacies in MANETs, similar to deafness, neighbour discovery, hidden terminals, overhead and so forth, potentially introduce glitches in the use of directional antennas. Hopefully, the existence of UWB features in the system may solve most of the problems, if not all. Therefore, the issue of high energy consumption may not be a problem with the first two layers of the network. However, the following issues require consideration while facilitating the re-design of the MAC protocols using UWB features in MANETs with a directional antenna system that is, radiation pattern use, interference control, and nulling capacity of the antenna system use. Other issues to be considered includes neighbour discovery and deafness.

The proposed model takes into account nearly all of the issues mentioned above and proffers a couple of benefits like low interference and jamming in the channel, high gain of transmission and reception, increase in transmission ranges regarding packet delivery ratio, and high energy conservation in the system. The model will also consider improving bandwidth utilisation, reducing the problems of exposing nodes High data rate and increasing spatial re-use of the channel. More so, it will also help to resolve the problems of high overhead in the network and the like. The benefits accrued are without prejudice to the existence of potential issues. However, based on the classification of the two different antenna systems presented, the proposed protocol will stick to the use of the directional system, as presented in Table 2.4 below.

Table 0.4: Omni and Directional antenna Properties

Omni system	Directional system
<ul style="list-style-type: none"> • Electromagnetic energy is received from all direction. 	<ul style="list-style-type: none"> • Electromagnetic energy is received within a specific direction.
<ul style="list-style-type: none"> • Transmission/reception drives through unspecified direction. 	<ul style="list-style-type: none"> • Transmission/reception drives through a specific direction.
<ul style="list-style-type: none"> • Low tolerance of interference, multipath, capacity and spatial reuse. 	<ul style="list-style-type: none"> • High tolerance of interference, multipath, capacity and spatial reuse.

2.20 Chapter Summary

This chapter lays the background of the basic concept of the research study. As the aim of the research work is to conserve energy in MANETs through the use of Ultra WideBand systems by modifying an existing MAC protocol, the definitions of the basic concept are presented to justify the need for the research study. A detailed background on MANETs, their generations and designs are presented, followed by the integrated system (UWB) and its applications in the wireless environment. UWB types, history, design and how the system works were also described to aid in the understanding of the research ideas and concepts.

Medium Access Control protocol is presented in detail, comprising its control frame format and the general frame format. Other components of the MAC have also been described and their relationship which exists in respect of how the channel works in terms of packet delivery from one device to another. Types of MAC protocols for wireless sensor networks have also been described in this chapter as well as the specific MAC protocols for MANETs. IEEE 802.15.3 as a protocol for implementation has also been described alongside the reasons behind selecting the protocol for modification.

The chapter also presents the meaning of power conservation and the different models for conserving power in wireless sensor and ad hoc networks. Finally, the chapter ends by presenting a detailed explanation of directional antenna systems and their application in saving power in MANETs using the UWB system.

Chapter Three

3.0 Literature Review

3.1 Introduction

As stated clearly in the background section, solving issues in wireless Mobile Ad Hoc Networks (MANETs) has to do with layers of the network and is based on the current outcome of many research works. It was found that there are many unsolved issues in the medium of transmission, routing and security associated with MANETs. However, wireless communication in the present world is a challenging field because everything is taking a wireless trend. Wireless technology can be seen as a tool to serve and simplify the working nature of everyday use gadgets. Communication in wireless environments has to do with sending/transmitting (TX) and receiving (RX) information from one point to another but, the challenging point is the medium of transmission because both TX and RX are identified. Thus, the channel capacities through which the transmission takes place remain the challenging issue. A great deal of literature has been produced on tackling the issues of the MAC layer yet, there are many unsolved issues which need to be addressed to boost the channel capacity in a wireless environment. However, before going into the literature more deeply, it is desirable to identify the key, existing challenges, in-depth characteristics and existing Algorithms/Models of the MAC protocol in MANETs in order to come up with well-structured literature.

3.2 Mobile Ad hoc Networks - Existing Challenges

The most significant factor in research is to identify challenging problems in the area because without challenge, there is no research. Research has indicated that many issues exist in MANETs due to their structure in terms of mobility, routing, topology and security [1]. These are the most basic ones. Going by the OSI reference model, at every level of the network, from

the Physical to the Application layer, different issues exist, for instance, the use of physical devices, use of the MAC protocol, use of the routing protocol and applications running in the network. According to [54], the existing challenges of MANET are distribution, dynamic topology, power awareness, addressing schemes, network size, security and medium of transmission. [55] identified that in multi-hop communication, security and topology constitute the prevalent issues. In MANETs therefore, it affects performance in terms of route discovery. Bakalis, et al. [56] uses computational analysis based on antenna design to discover that extreme resource consumption, particularly in routing operations, is another active challenge in MANETs which leads to poor performance. At the same time, topology changes due to mobility [1], energy issues and heavy applications in MANETs can also be seen as existing problems. These can be categorised in three different areas as stated by [1]: backbone/gateway for connectivity, defining appropriate routing protocols in order to support the backbone/gateway and finally, supporting the use of mobility.

Furthermore, communication protocols, especially medium access control and some defined algorithms, are other factors that hinder performance of MANETs in terms of quality of service which appears as a result of poor performance of these protocols [57, 58]. Lack of strong communication protocols (MAC) to initiate, guide and terminate the transmission will lead to high package drop [59]. Nagaprasad, et al. [60] also suggests that bandwidth limitation and computational capacity of the nodes are other unsolved issues in MANETs but, based on the analysis, the paper suggests that MAC should be redesigned to suit the nature of MANETs in terms of their dynamic environment. This is because with good MAC and routing protocols in MANETs, there can be good quality of service [60]. Figure 3.1 illustrates the summary of existing issues of MANETs.

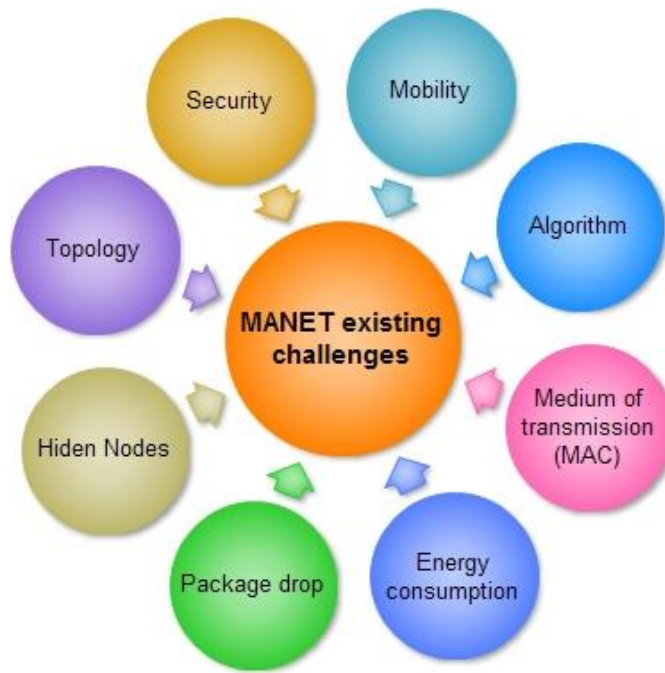

Figure 0.1: MANET Summary of Existing Challenges

We have conducted a systematic study on existing research works that have been undertaken in solving existing MANET problems from 2000 to 2017, based on the identified key issues mentioned above. That is, issues of optimising MANET performance with respect to algorithm, limited bandwidth consumption, energy consumption, medium of transmission (MAC), mobility, routing, security and topology. The study reveals that the least effort has been targeted towards the area of medium of transmission. Table 3.1 below shows the summary in percentage with respect to challenges and years, followed by the chart in Figure 3.2.

Table 3.1 was formed based on the analysis conducted in Nvivo from number of journal papers collected from 2000 to 2017 that has to do with the study. Information based on the existing challenges were queried and samples nodes were created for analysis from the sources. The used of coding techniques were carried out in order to compare the existing challenges which generate table 3.1 and figure 3.2.

Table 0.1: Analysis of existing challenges of MANET from 2000 to 2017

Years	Algorithms (%)	Bandwidth (%)	Energy consumption (%)	MAC (%)	Mobility (%)	Routing (%)	Security (%)	Topology (%)	Total (%)
2017	10	15	32	5	14	8	10	6	100
2016	16	22	16	4.5	10	7	19	5.5	100
2015	18	8.7	13	3.7	20	14	17	5.6	100
2014	17	4	5	3	10	19	15	27	100
2013	9	6	14	2	5	46	12	6	100
2012	5	5	9	3	17	30	24	7	100
2011	16	5	20	4	9	25	13	8	100
2010	6	9	8	6	24	31	6	10	100
2009	16	14	14	13	14	15	10	4	100
2008	7	15	12	11	12	16	12	15	100
2007	7	2	8	7	8	44	18	6	100
2006	8	7	33	2	23	13	8	6	100
2005	9	6	27	3	8	23	7	17	100
2004	5	5	40	4	12	23	3	8	100
2003	6	4	9	3	18	42	10	8	100
2002	10	17	12	11	18	8	15	9	100
2001	20	16	17	5	12	10	9	11	100
2000	5	6	38	2	14	12	15	8	100

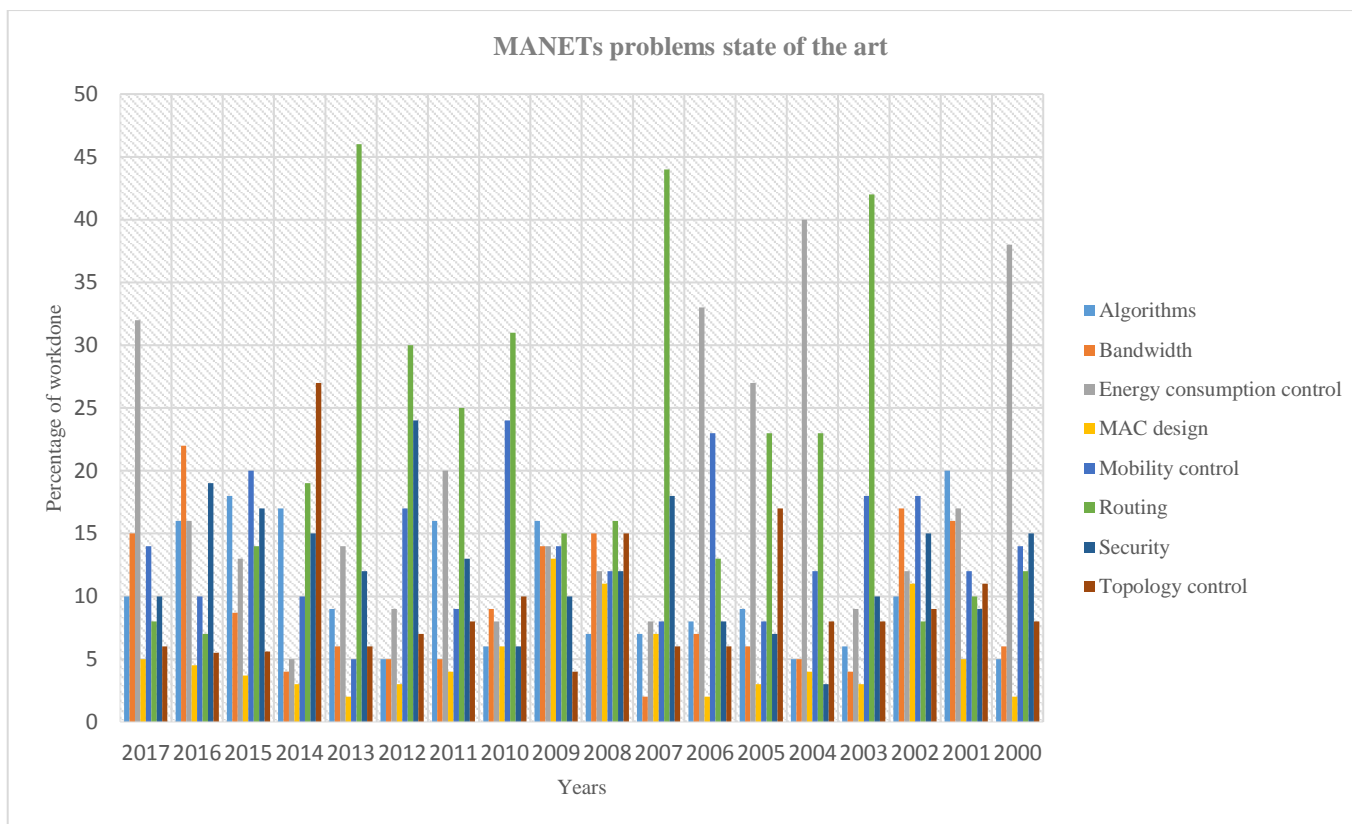

Figure 0.2: Analysis of existing challenges of MANET from 2000 to 2017

Therefore, we looked into the limited effort in research in the area of the MAC protocol as the research gap in the MANET environment. Hence, this research work will be focused on optimising the performance of the medium of transmission (MAC) using UWB technology.

3.3 MANET in-depth Characteristics

To optimise the performance of MANETs, it is important to identify the unique characteristics and in-depth behaviours of MANETs in order to justify the need for the research. Since it is one of the emerging technologies of today's debate in wireless communication, it is quite important to iterate its current behaviours in order to come up with strong solutions to its existing problems. Statistics seem to indicate that network infrastructure, network topology, self-organisation, limited resources, poor physical security, routing and transmission in MANETs are entirely different from those of normal, conventional networks [54, 61]. In addition, self-configuration, self-creation, mobility and non-existence of administrative devices describe the network infrastructure in MANETs. Dynamism and instability describe the MANET network topology. In addition, the lack of central administration and distribution describe its self-organisation. A MANET has limited resources for energy, memory, supported devices, battery and finally, limited bandwidth. Furthermore, poor physical security, as well as poor scalability, are the main security issues in MANETs [62]. Consequently, routing and transmission in MANETs can be on-demand/reactive/hybrid and multi-hop respectively [63]. Table 3.2 summarises the in-depth characteristics of MANETs.

Table 0.2: Characteristic of MANET

S/N	CHARACTERISTICS	FEATURES
1.	Network Infrastructure	<ul style="list-style-type: none">- No fixed infrastructure- Mobility- Self-configuration- Self-creation
2.	Network topology	<ul style="list-style-type: none">- Dynamic- Unstable
3.	Self-configuration	<ul style="list-style-type: none">- No central administration- Distributed in nature
4.	Limited resources	<ul style="list-style-type: none">- Energy, memory, and computational- Small devices operation- Battery operated- Limited bandwidth
5.	Security	<ul style="list-style-type: none">- Poor physical security- Poor security in terms of scalability
6.	Routing	<ul style="list-style-type: none">- On-demand, reactive and Hybrid
7.	Transmission	<ul style="list-style-type: none">- Multi-hop transmission

3.4 Ultra WideBand (UWB) Technology

The life cycle of mobile ad hoc networks can be categorised into first, second and third generations. The first generation of the ad hoc network was way back in the 1970s. According to [64], the Defence Advanced Research Projects Agency (DARPA) initiated research on the feasibility of using packet-switched radio communications to provide reliable computer communications; it was called Packet Radio Network (PRNET) [65]. PRNET makes use of the combination of Area Location of Hazardous Atmosphere (ALOHA) and Carrier Sense Multiple Access (CSMA) [65] for multiple access and distance vector routing. The routing protocols used in PRNET were designed to enable reliability, speed and correctness and also network management facilities. PRNET later evolved into the Survivable Adaptive Radio Network (SURAN) in the early 1980s [64].

SURAN was used to provide a packet switched network to the mobile battlefield in environments without infrastructure. Additionally, it proved to be beneficial in improving the radio's performance by making it smaller, more secure and less expensive [66]. The advent of laptop computers and other mobile devices in the 1990s led to the concept of commercial ad hoc networks as shown in Fig. 1. Ever since the 1990s, numerous works have been carried out on ad hoc network standards. Around the same time, a mobile ad hoc network working group was developed within the IETF (Internet Engineering Task Force) in order to standardise IP (Internet Protocol) functionality appropriate for wireless routing applications within both static and dynamic topologies with increased dynamics due to node motion and other factors. The routing protocols were based on hierarchical link-state and were highly scalable. The idea of the collection of mobile nodes was proposed in research and conferences which then revived mobile ad hoc networks as a potential technology. The present ad hoc network systems are considered under the third generation [64].



Figure 0.3: Mobile Ad hoc Network (MANET)

Mobile devices depend on batteries for energy supply and since battery power is limited, energy conservation constitutes one of the greatest issues in designing algorithms for mobile devices [20]. Several pieces of research undertaken in battery technology show that only a slight improvement in battery life is expected in the near future [67]. [67]. It is thus essential that power management should be optimised efficiently by identifying different mediums to reduce the usage of power without affecting the efficiency of the application. Limitations on battery life and the extra energy requirements for assisting network operations, such as transmission or reception in each node in a MANET, makes the issue of power management one of the main concerns in ad hoc networking. Power management techniques have been proposed at several levels of a mobile device including the physical-layer transmissions, the operating system and the applications [68].

Ultra WideBand (UWB) technology is a method of transmitting high signals that constitute a large amount of bandwidth with low power consumption in both the transmitting and the

receiving ends. It is a wideband frequency that spreads over a large bandwidth greater than 500MHz compared to narrowband of approximately 1.25MHz. In 2002, the Federal Communication Commission (FCC) unconfined regulation for authorised use of unlicensed versions of UWB in the range of 3.1Hz – 10.6GHz for radar and imaging, low data rate applications and Personal Area Networks (PAN), in addition to the supply of high data rate wireless devices [20]. There is a huge difference between narrowband and UWB. Traditional (narrowband) deals directly with power, frequency and phase of a sinusoidal wave, while UWB generates radio energy with respect to time and the imposition of high bandwidth into channels resulting in a pulse-position or time-modulation. The measured difference is the time-variation ($X_i(t, T)$) which is not present in narrowband techniques. It serves as a distinguishing property of UWB channels and it is a constant value added from the real equation of the communication channel [69]. UWB has the capacity to provide high resolution between the transmitter and receiver because of its intelligence in determining the time of flight which is a two-way time transfer technique often called multi-path communication technique. According to a statistical analysis on the competitors for the high-data-rate, short-range market recently, the results indicate that UWB is significant compared to IEEE 802.11b, IEEE 802.11a and Bluetooth technology because of its forcefulness in penetrating through strong buildings and trees and its tolerance to noise in the channel [70]. The transmission using UWB pulse radio produces a huge output which occupies a very large frequency spectrum [20]. UWB technology can be employed in many areas especially, home networking, industrial automation, vehicular radar systems, medical monitoring, military situations (war zones), disaster recovery (fire, flood, earthquake) and national crises and so forth which do not require any specific courtesy [3]. In Figure 2, the system summarises basic features, applications and the performance output of UWB technology.

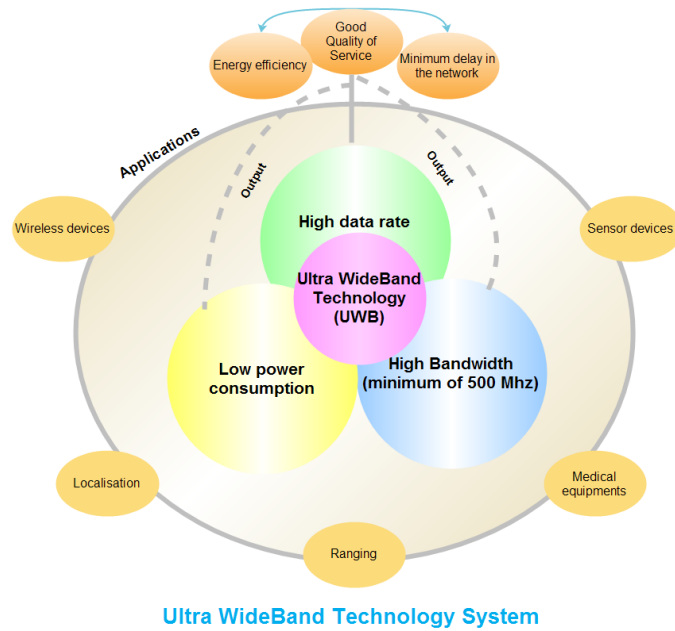

Figure 0.4: UWB features, applications and performance output

In every system there are both advantages and disadvantages. The advantages attached to UWB technology however, are much greater than its disadvantages. Some of the major advantages have already been stated earlier like high data rate, low probability of detection and interception, robustness for multi-path, low power dissipation, enormous bandwidth availability, low implementation cost and finally, low power consumption [71]. Summarised, the six potentials of UWB are as follows:

- i. Low power operation
- ii. UWB transmissions below the noise level (providing low probability of detection - LPD)
- iii. Low probability of jamming (LPJ)
- iv. Ability to penetrate walls and vegetation due to low frequency
- v. High immunity to multi-path fading effects
- vi. Availability of precise location information

[71] then pin points the major disadvantages of UWB technology as follows:

- i. Long signal acquisition time
- ii. Federal Communication Commission (FCC) regulation issues
- iii. Several technical implementation issues at the PHY layer such as antenna design, propagation and channel modelling, device and circuit design and wave form design

The implementation of this research work is based on basic layers of the network, that is, either on the physical layer, Media Access Control (MAC) or Network (Routing stage), depending on the outcome of the related review. Meanwhile, this research will focus on using Ultra WideBand Technology to investigate, develop and implement workable solutions at a certain level for optimising the performance of Mobile Ad hoc Networks.

3.5 Applications of UWB Technology in MANET

According to the Wireless World Research Forum (WWRF), studies have revealed that in recent years, for any organisation which is willing to enhance the potentiality of wireless devices, especially beyond third generation (3G) networks, the inclusion of UWB technology must be considered[19]. The WWRF will come up with a suitable technique for exploring the use of UWB technology in the development of future wireless devices. In MANETs, transmission of information is based on short range communication which results in several issues like packet drop rate, low QoS, delay and high energy conservation by mobile devices. However, integrating UWB MAC in MANETs will boost the communication channel to overcome these problems. Topology is one of the problems pointed to in Figure 2. Due to the unspecified arrangement of mobile nodes, locating devices in such an environment will become an issue. Subsequently, UWB technology will help in providing easy location tracking in the network.

UWB technology is widely used in medical environments, particularly for bio-embedded chips designed for detection and tracking systems. It is also used severally as a transformative technology for high-data and low-power wireless bio-medical applications [20]. According to [20], UWB technology can be used in designing pulse generators/transmitters and powerful antennas. Thus, in wireless devices, antennas are the paramount components to consider when describing the properties of that device. The transmission of signal with UWB antennas produces minimum distortion by keeping the pulse shape and the amplitude of the signal in the time and frequency domain [20].

The use of UWB technology, in terms of localisation in MANET, with respect to tracking due to the decentralisation and mobility of the nodes, will also help to overcome the issue of energy constraint because it will facilitate node discovery and co-operation [21]. Tracking down high energy consumption by mobile devices has to do with the basic layers of OSI from PHY to application, in which UWB will support all the layers with minimum technical issues if implemented accordingly. Current research has revealed that no technology surpasses UWB in the provision of large bandwidth, low power consumption and localisation [21]. Localisation is a factor that diminishes the performance of mobile devices in a network, especially when there is high propagation in the channel. This therefore leads to high delay in communication in a multi-path environment. Multi-path communication with high delay creates a distortion of signal. According to [22], time reversal algorithms can be used with UWB to reduce delay in MANETs by influencing good frequency and adding high bandwidth into the channel. UWB can be used to achieve accurate localisation through the physical layer by reducing Bit Error Rate (BER) and mitigating the multi-user interference (MUI) and Gaussian Noise Interference [23].

In addition, routing is another major issue in MANETs, especially when the nodes are carrying heavy applications. The communication produces low QoS because the routing table is

congested. With the integration of UWB however, the routing table will be expanded so that the channel is used extensively. The technology has been tested on different MANET routing protocols, majorly in data communication with some in heavy applications [24]. The implementation of a novel routing strategy by [24] shows that in an on-demand routing environment, the use of UWB technology can effectively reduce the routing load and the QoS, with end-to-end delay, will be satisfactory.

Using impulse, UWB technology in a MANET radio network will help to minimise the signal relay time delay and also solve the problem of media multiple access while improving the performance of the network [25]. The use of multiple access techniques, as supported by UWB, will allow simultaneous transmission and code division which will allow for maximum utilisation of the channel as stated in [25].

3.6 UWB MAC in MANET

Medium Access Control is a transmission protocol that resides in-between the data link and physical layers of the OSI model. It serves as an inter-protocol unit that provides unicast, multicast/broadcast communication which also emulates a full-duplex valid communication path in a multi-point network. It is a sub-layer protocol which initiates addressing and channel access control techniques for devices to share the communication medium. Consequently, this will produce a strong, multi-access technique in the network. Medium access control protocol manages, accounts for and schedules all the activities which take place in the transmission channel. The standard MAC protocol, adapted in general wireless communication environments, has no effect while running in MANET environments, irrespective of the application administered [72]. However, considering the unique description of UWB technology, if implemented in MANETs, this would require optimisation in order to work more effectively for the MANET purpose [9].

MAC protocols can either be centralised or distributed. As stated earlier, MANETs are a distributed network which forms as a result of connecting mobile devices together without administrative support. Therefore, the MAC protocol in MANETs is also distributed in nature. In a distributed context, all nodes are master nodes due to the power of transmitting and receiving. Each and every node takes part in the MAC operation. The distributed MAC is much more complex than the centralised one. However, it is scalable and more reliable. Meanwhile, based on this research, distributed MAC can be categorised basically into standards such as IEEE 802.11 (Wifi), 802.20, IEEE 802.22, IEEE 802.16 (WiMax), IEEE 802.15.1 (Bluetooth), IEEE 802.15.3 (UWB) and IEEE 802.15.4 (Zigbee). Research has shown that there are increasing numbers of proposed algorithms, models and assumptions for optimisation of the MAC protocol using UWB technology in MANETs [73]. The table below demonstrates some differences between the centralized and distributed MAC protocols, stating their general and unique features.

Table 0.3: Characteristics of MAC Protocols

CENTRALISED MAC	DISTRIBUTED MAC
1. Control by central device to coordinate the communication.	No central device to coordinate the communication.
2. High throughput and quality of service for small networks	It has weak security but can be improved
3. Collision can be avoided because of reliability.	It can support large networks that constitute a large number of devices operated
4. Good for Wireless personal Area Networks (WPANs) especially for multimedia purpose, low latency computers to reduce overhead.	Low QoS because the connection is not reliable but can be improved.
5. Good coordination in communication medium by assigning code channels, enforces QoS requirement, control power saving modes and manage access to the devices.	Is a random access protocol started with ALOHA techniques and later upgraded to Slotted ALOHA, CSMA, CSMA/CD and CSMA. These techniques overcome the problem of collision by exposing hidden terminals, introduces handshaking based on Request-To-Send/Clear-To-Send (RTS/CTS) and using back off/persistence mechanism[9].

Going by the above characteristics of both the centralized and distributed MAC protocols, and while considering the nature of MANETs, the unique features of UWB can be implemented in MAC as long as the design has not been tampered with. It is probable that the UWB MAC protocol can either be single-band or multi-band [4] which describes the strength of the protocol. The major challenge of MANETs today is how to manage the energy of mobile devices in the network due to mobility, geographical area and topology, considering the network's absence of a centralized co-ordinating device [54].

3.7 Role of UWB MAC on Routing in MANET

MANET routing protocols are different from conventional routing protocols. According to [74], MANET routing protocols can be classified in so many ways, most of which depend on routing strategy and network structure. In addition, according to the routing strategy, the routing protocols can be characterised as table-driven and source initiated, while depending on the network structure, they can be classified as flat, hierarchical or geographic position assisted routing [74]. MANET routing protocols are also classified based on the following [75]:

- i. Centralised and distributed
- ii. Static and adaptive
- iii. Reactive and proactive

In centralised algorithms, all route choices are made at a central node, while in distributed algorithms, the computation of routes is shared among the network nodes.

Another classification of routing protocols relates to whether they change routes in response to the traffic input patterns. In static algorithms, the route used by source-destination pairs is fixed, regardless of traffic conditions. It can only change in response to a node or link failure. This type of algorithm cannot achieve high throughput under a broad variety of traffic input patterns.

Most major packet networks use some form of adaptive routing where the routes for packets between source-destination pairs may change in response to congestion.

Proactive protocols attempt to constantly evaluate the routes within the network, so that when a packet needs to be forwarded, the route is already known and can be immediately used. Reactive protocols on the other hand, invoke a route determination procedure on demand only. Thus, when a route is needed, some sort of global search procedure is employed. The family of classical flooding algorithms belongs to the reactive group. Proactive schemes have the advantage that when a route is needed, the delay before actual packets can be sent is very slight. On the other hand, proactive schemes need time to converge to a steady state. This can cause problems if the topology is changing frequently [76].

The role of UWB MAC on routing in MANETs is extremely vital due to competition in accessing the medium of transmission, especially in a network with high density. Therefore, it will reduce the energy consumption and increase the performance of the network [3]. Also, a well-designed MAC protocol will help routing algorithms to reduce multiple collisions and retransmissions [76]. Routing algorithms requires good transmission protocols which are designed for minimal power consumption.

3.8 The Role of UWB-MAC to improve Quality of Service in MANET

The total output received by users in a network, be it positive or negative, can be referred to as the quality of service of the network. Services like energy conserved by the nodes, bandwidth use, throughput, error rate, availability, transmission delay and jitter, can be measured quantitatively to understand whether the quality of service of the network is fine or awful. Most quality of service techniques can be achieved through routing schemes. Meanwhile, most of the existing techniques have not addressed the issue of energy conservation [77] especially

when dealing with the MAC protocol. Good QoS schemes in MANETs should address issues of energy or power. These entities play a vital role in the network considering all mobile devices are dynamically changing with respect to location, position and limited amount of battery power. Using UWB MAC in MANETs will optimise the QoS because it will overcome the problems of low bandwidth delay and will conserve energy and solve problems of localisation [77].

IEEE 802.15.4 is in the neighbourhood features of UWB technology but with slight differences of power consumption, reliability and delay. The difference lies in selecting suitable parameters for implementation by defining the protocol performance limitation and to identify first-rate parameters to be used in order to improve the QoS of the network [78]. Yue [79] proposed an adaptive MAC protocol based on a resource allocation algorithm, using the same techniques proposed by Cuomo [80] which is a classic resource allocation algorithm. The algorithm has been used to enhance the quality of service in conventional wireless networks considering the four basic parameters of throughput, admission ratio, energy consumption and delay. Going by the mobility nature of MANETs, the algorithm has to be improved to suit the working nature of MANETs for better quality of service.

Performance analysis based on the quality of service using the UWB MAC protocol (IEEE 802.15.4) and ordinary IEEE 802.11x has been done by Kejie [81] taking into account the bursting-frame-based technique, and the results indicate that energy consumption is high. QoS has been optimised through injecting high buffers into the channel without considering the power consumed by the mobile devices which end up affecting the performance of the network. The techniques end up bursting the channel, while the devices received high data without much delay. Energy wise however, the transmission will not last long. Atef [82] proposed a cross-layer technique using the PHY, MAC and network layers in the context of the resource allocation scheme in order to provide guaranteed QoS in the network with consideration of

position. This resulted in some issues that have not been resolved. The algorithm is capable of handling centralised control Time-Division Multiple-Access while only helping the positioning of mobile devices with no regard to power consumption. The technique works by adjusting the distance between the nodes automatically in both the two original systems of MAC design as in Direct Sequence (DS) – UWB and Multi-Band Orthogonal Frequency-Division Multiplexing (MB-OFDM) [82].

3.9 Review of Power Management Techniques in MANET

Power management techniques, if perfectly implemented in MANET using UWB-MAC, would play an important role in enhancing the performance of a network. This is because mobile devices require power models that consume low energy in order to prolong their participation in the communication environment. Energy serves as one of the most important variables for the nodes therefore, controlling its usage is highly recommended due to the distributed nature of MANET. Muegent in [83] article states the importance of power control in wireless sensor networks which is also applicable in MANET with less deficiency. These are:

- i. It would prolong the life span of mobile devices and increase the QoS.
- ii. It would decrease collision in the network.
- iii. It would help to obtain low, end-to-end time delay.
- iv. It would help to ensure resource utilisation with high efficiency.

Hwang, et al. [84] propose the New Power Saving Mechanism (NPSM) in the Distributed Coordinate Function (DCF) of a MAC protocol in order to improve power conservation in a wireless network. The NPSM operates in a way that does not utilize the Ad hoc Traffic Indication Message (ATIM) window but uses bandwidth for transmission. The operation of the

ATIM is stated to conserve more energy because every node stays awake. A node transmits an ATIM frame to the destination node during the ATIM window any time it wants to transmit, and the destination nodes reply with the ATIM- ACK. After this has been completed, both sources and destination nodes stay awake for the other entire beacon interval to complete transmission. Any node that is not involved in transmission and reception of an ATIM frame may enter *doze* state after completing its ATIM window. A wireless network interface can either be in the *awake* state or *doze* state. The *awake* state consists of three modes that consume different amounts of energy. They are *transmit mode*, *receive mode* and *idle mode*. The *doze state* however, does no transmission and reception; it is a state where the nodes temporarily stay off and hence, consume less energy. A substantial amount of power is consumed when these nodes change their state from the *doze state* to the *awake state*, or vice versa. Results obtained from simulations carried out to analyse power consumption between the network without PSM, the one with PSM and network with the proposed NPSM, show that the network with NPSM consumed less energy when compared with the PSM and the network without PSM [84]. This experiment would cause large delays and would not be able to adapt to networks with high traffic.

Sharma and Kush [85] proposed a Power Aware Multiple Access Protocol (PAMAS); this allows inactive nodes to go into *doze state* any time neighbouring nodes are transmitting. The protocol uses a separate channel for packet transmission and another one for control. The control channel enables a node to determine when and how long it will power off the wireless network interfaces.

Park, et al. [86] also improved the Power Saving Mechanism (PSM) in ad hoc networks against delay and throughput and therefore, proposed an Improved Power Saving Mechanism (IPSM) whereby nodes in route stay awake and the others remain switched off. Media Access Control (MAC) protocols can sense medium and determine if packets are to be sent or received which

makes them suitable for turning off the MANET devices radio when idle. They used MAC layer information to switch off the wireless network interfaces which are based on the IEEE 802.11 Power Saving Mechanism (PSM). Results obtained from the simulation to compare the performance of the network with IPSM to the network with conventional IEEE 802.11, show that the IPSM achieves lower delay, higher throughput and lower energy consumption than the conventional IEEE 802 series. To the best of the author's knowledge, the power saving mechanism in this algorithm can be improved because that power is also utilised by the nodes when they are sleeping.

Ray and Turuk [87] propose a technique to conserve power for ad hoc wireless networks; the span uses the IEEE 802.11 PSM. The span selects co-ordinators that would stay awake and forward traffic for active connections. The co-ordinators constantly rotate their roles. The non-co-ordinators maintain the PSM operation in IEEE 802.11 DCF. Packets destined for nodes in doze state are buffered and announced by the nodes in awake state during the ATIM window. Span then introduces a new advertised traffic window during which the announced packets and packets for the co-ordinators can be transmitted. However, [84] also propose a similar adaptive mechanism that chooses a suitable ATIM window size hence, making the nodes stay awake for only a particular duration of the beacon interval according to the ATIM window. Simulation results show that the proposed protocol was able to conserve energy when compared to the conventional IEEE 802.11 DCF.

George, et al. [88] propose a Sensor Media Access Control (SMAC). This protocol allows inactive nodes to sleep when neighbouring nodes are transmitting. The SMAC operates differently to PAMAS. The SMAC causes a node to enter *doze state* after hearing a Ready to Send (RTS) or Clear to Send (CTS) destined for a neighbouring node. Simulation results showed that the SMAC protocol consumes about 2-6 times less than the conventional IEEE 802.11 MAC protocol. The major factors which make power management in a MANET a tough

task are that any node could function as a data transmit as well as receivers, and secondly, because there are no centralised entities or access points where power management and control of each node can be done [87].

Sharma and Bhadauria [89] proposed a Congestion and Power Control Technique Based on Agent in MANET. The mobile agent from source starts forwarding the data packets through the path which has minimum cost and congestion. The status of every node is collected and eventually sent to the target node. They also designed their power control technique to make node selection based on the power level whereby the nodes with maximum power level are selected as listening nodes (LN) which will always be in active mode and the other nodes are selected as non-listening nodes (NLN) which will be awake in a periodic manner. If the node getting the data packet is not in the awake state, the packet is transmitted through LN to the destination.

Hwang, et al. [84] propose a technique that controls power at the MAC layer. This technique obtains the minimum power level between two communicating stations to reduce total interference hence, reducing the capacity of the wireless network. By fixing a constant power to the network to topology, they were able to show that an increase in interference would lead to an increase in throughput.

According to [90], the topology of an ad hoc network is determined by the transmission power and optimal transmission power is also determined by the network load, the station and network size. They were able to prove this argument by deriving the analytical throughput model as a function of transmission power which show that an increase in throughput results in an increase in transmission power in a normal ad hoc environment. The conclusion was reached that the transmission power should be tuned to the ad hoc network environment to maximize throughput and hence, reduce power consumption.

Guan, et al. [91] propose two algorithms to show the importance of topology control and transmit power control in ad hoc wireless networks. These algorithms also create a connected and bi-connected network using a centralised and distributive technique. The algorithm dynamically tunes its transmission power in a way that the maximum transmit power used is minimized while keeping the network bi-connected. Results proved that connectivity and bi-connectivity optimise throughput and reduce power consumption.

Safa and Mirza [92] propose an algorithm for nodes to locally determine their transmit power collectively in order to ensure global connectivity. This operates in a way that the node stores its transmit power until it finds neighbouring nodes in all directions of transmission, thereby reducing the transmit power. The reduction in transmit power improves the rate at which power is consumed but could result in an increase in delay.

3.10 Choice of MAC protocol for MANET

Going by the literature review conducted so far in MANET on the existing MAC protocol, specifically on power saving, the choice of MAC protocol depends on some basic criteria: the MAC protocol should be cost effective, unimportant in terms of size, simple design in structure and finally, the protocol should consume less power. The most active MAC protocols suitable for MANET with UWB features in this present wireless communication arena, are IEEE 802.15.3, IEEE 802.15.4 and Bluetooth (IEEE 802.15.1) technology. The following should be judged according to their power management - how terminals conserve energy in the communication medium, the rate of data at which each protocol transmits information – maximum data rate at which each protocol transmits data within a specific time interval, support for different applications like multimedia (voice and video) and finally, the distance at which each protocol transmits information.

Based on the behaviour of MANET depicted earlier in the research study, showing that mobile nodes consume high power, the need for power management in MAC is vital, especially when looking at how power is being utilised on display, processing and transceivers. Previous protocols (like IEEE 802.11/a/b/g) suffered much in terms of power management compared to IEEE 802.15.3, IEEE 802.15.4 and IEEE 802.15.1 in prolonging battery life. In the middle of these three protocols, IEEE 802.15.3 has advanced power management compared to the rest because the current drain of battery in transmission is the minimum (80mA). Similarly, in an idle mode, or power saving mode, it consumes less power. Due to its advanced power management scheme, it gives standard quality of service even when terminals are in power saving mode. IEEE 802.15.3 basically has three power saving modes which are:

- i. Synchronised Power Save (SPS)
- ii. Peaconet Synchronised Power Save (PSPS)
- iii. Hibernate Mode

While Bluetooth has the following:

- i. Hold
- ii. Sniff
- iii. Park

With regards to data rate, support for applications and distance, IEEE 802.15.3 has high acceptance in MANET because it consumes less power, transmits high data, has less cost and is simple in design. Table 3.4 below summarise the characteristics of these protocols based on power consumption, data rate, distance, application and so forth.

Table 0.4: UWB-MAC protocols for MANET

Protocol	Power	Range	Cost	Rate	Spectrum	Modulation (PHY)	Channel Access	Interference	Security	Application
IEEE 802.15.3	Less than 80mA	Less than 10m for MANET	Very low	11 – 55Mbps	2.402 – 2.480GHz	Both IR and MC	CSMA/CA and GTS in super frame structure	Present	Authentication, encryption, digital certified service, and privacy is present. The level of security is higher compare to IEEE 802.15.4 and Bluetooth.	Uses GTS for voice and other multimedia applications at rate of 128kbps
IEEE 802.15.4	20 – 50Ma	Less than 20m	Medium	858MHz but precisely 20 - 250kbps	2.4GHz – 868915MHz	Both IR and MC but better with DSSS	CSMA/CA and GTS in super frame structure	Present	On process of development	Does not support voice
IEEE 802.15.1	10 - 60mA	Less than 10m	less	Up to 1Mbps but allow up 8 devices operate in a single peaconet	2.4GHz ISM Band	FHSS at 1600bps	Master/slave polling time division duplex (TDD)	Present	Less security compare to IEEE 802.15.3	Support voice and is provided by Telephone control protocol specification (TCS). Transmit maximum of 64kbps for voice and data.

With the analysis above, design of the proposed MAC protocol will be based on IEEE 802.15.3 architecture, with prior consideration on power management and other design parameters in order to improve the protocol standard and boost the performance of MANET to ensure that good quality of service will be maintained.

3.11 IEEE 802.15.3 Overview

In 2005, IEEE launched a study group to come up with a new media access protocol which would provide a high speed Physical layer (PHY). That protocol was designated as IEEE802.15.3 standard. The basic features of the protocol are to deploy a high data rate, short range and low energy consumption in the network. The minimum data rate to be deployed is 110 Mbps at 10m [93] and therefore, this will resolve the issue of using high applications like video or multimedia acquaintances. Part of the objectives of establishing the protocol is also to analyse different radio channel models that can be used in various wide band systems, especially UWB systems, for evaluation and implementation. Sulaiman, et al. [94] itemise the target applications to be implemented in the protocol which may involve imaging and multimedia applications with specific characteristics of the protocol as in [95]. The proposed characteristics of IEEE 802.15.3 PHY layer are as follows:

- Cohabitation with all existing IEEE 802 physical layer standards
- Target data rate in excess of 100 Mbps for consumer applications
- Robust multi-path performance
- Location awareness
- Use of additional unlicensed spectrum for high-rate WPANs (Wireless Personal Area Network).

The proposal was not meant specifically for UWB standard but with considerable similarities, particularly when implemented in an ad hoc network environment. The standard requires some technical entities to be adjusted for successful implementation in UWB technology.

3.11.1 IEEE 802.15.3 for MANET

The design of 802.15.3 architecture was meant specifically for ad hoc network implementation and other applications, like multimedia service, in order to provide the best quality of service and to manage power efficiency. It also has almost all the qualities of UWB technology as stated earlier. Due to the behaviour of MANET, node participation in the network does not have to seek permission to join or leave the network because of its flexibility. The beacon interval, guaranteed time slot (GTS) and the contention access period (CAP) constitute the 802.15.3 MAC super frame structure as illustrated in Figure 3.5.

QoS provision, like multimedia applications, can be transmitted. This boundary can be adjusted dynamically, if conditions warrant, for analysis.

The most important factor to be considered when selecting IEEE 802.15.3 for MANET is its power management which is also the main factor which constitutes the need for the research study. The MAC protocol has an improved mechanism for lowering the amount of current drain if a terminal connects or leaves the network. The physical characteristics of the protocol (PHY) also have to be considered when designing the proposed protocol and these are stated below:

Frequency band = between 2.4GHz and 2.4835GHz

Data rate = 11 – 55Mb/s

Symbol rate = 11Mbaud

Modulation = Uncoded QPSK (at 22Mb/s), trellis coded QPSK, 16/32/64 – QAM (at 11,33,44,55Mb/s)

IEEE 802.15.3 has a special mechanism attached to the modulation frequency which is also known as a drop back mode. It consists of 11Mb/s in QPSK/TCM transmission for overcoming problems of hidden terminals in the network. It constitutes 15MHz of bandwidth for each channel and the power level should be at least 0dBm, as suggested by the FCC. The connection time of terminals in an existing network is among the factors to be considered when selecting the MAC protocol to be used. Other MANET MAC protocols have high connection times compared to IEEE 802.15.3, which has a minimum connection time of less than 1s.

3.12 Power parameters for UWB-MAC in MANET

3.12.1 Sources for energy in-efficiency in MANET

To come up with power parameters to be used for the research implementation, the causes of energy inefficiency in MANET were considered, with a brief explanation given in order to justify the need for the parameters. The most common sources of energy inefficiency in MANET are collision, overhearing, over emitting, idle listening and protocol overhead.

Collision:

Collision occurs in a network as a result of traffic mash in the communication channel: two or more devices want to access the medium at the same time. Collision can also occur as a result of hidden and exposed terminals in a network, especially in a distributed network. Also, if a network is over populated as a result of many terminals participating, the rate of collision will be high, especially when using techniques that cannot avoid or detect collision. Collision is one of the sources of energy inefficiency in MANET and this can be addressed by developing a powerful UWB-MAC protocol. Whilst many techniques are in place for avoiding and detecting collisions in a network like CSMA/CD and CSMA/CA, an enhanced MAC protocol is still needed for optimisation.

Overhearing:

Overhearing occurs in a network when other devices capture information that is not destined for them. This occurs as a result of exposed terminals, where terminals listen to information broadcast by other terminals in order to know the destination of that information, to avoid transmission while the terminal is also transmitting. If there is a great deal of overhearing in a network, the energy consumption of the terminals will be high. There are different techniques

in place to overcome the problem of overhearing in MANET, especially at the MAC layer, but a lot still needs to be done.

Over emitting:

Over emitting occurs when a particular node sends information to an unprepared terminal. This can occur when the terminal is out of range, is in a sleep mode, in an idle mode or when the terminal is busy. All these features will consume energy in one way or another.

Idle listening:

Idle listening is the time when a node waits for the next incoming transmission. The node is active and energy is utilised. The energy consumed while the terminal is in idle listening serves as wasted energy, thereby causing the terminal to lose much of its energy.

Protocol overhead:

This occurs when excess bandwidth is used to send information about other terminals and their routing information. The energy wasted for gathering information about other devices will have effects on the bandwidth allocated to a particular terminal and this will cause low throughput in the network, resulting in low quality of service.

3.12.2 UWB Parameters and Matrices

According to FCC and the Ultra WideBand Concept for Ad hoc Networks (UCAN), the design of a new MAC protocol for the UWB system in MANET should be based on the existing MAC protocol in order to provide interoperability between existing narrowband technology and UWB technology [96]. The design should organize the short range communication, hotspot coverage and network backbone interconnection and finally, clusters of ad hoc networks with high density of nodes considering positioning/localisation using manage hopping [97].

Therefore, the architecture of our proposed UWB MAC would be based on UCAN architecture with respect to Wireless Personal Area Network (WPAN) and medium (WLAN) range but specifically on power consumption.

Gupta and Mohapatra [97] states that the UWB-MAC protocol must have the following attributes, especially when trying to minimise power consumption, that is, high channel acquisition time as a result of long synchronisation, ranging abilities, low power operation and carrier-less pulse position modulation. UWB design parameters that are required in a wireless network can be determined by the method in which a user can decode a specific data stream, giving priority to all users to access the medium of transmission and alter the design architecture of the existing techniques to provide sufficient performance in the communication system [97]. In this research study, the focus will be on redesigning the existing architecture of the MAC protocol in MANET in order to provide sufficient performance in terms of power efficiency. The proposed MAC would have the unique features of UWB systems.

Adopting the UCAN approach of designing the proposed MAC protocol and coming up with the power parameters is the best approach so far. This is because it will solve the problem of localisation with respect to ranging, distance measurement and also part of routing when considering cross-layer design [97]. The general assumption made by UCAN for associating UWB systems, especially when designing MAC protocols for MANET, is based on a link additive cost function. The summation of cost effectiveness of power consumption, network setup, interference in terms of different modulation techniques, quality of communication and the total delay are such that be summarise as in equation 3.1:

Power:

$$C = C(\text{power consumption}) + C(\text{Network setup}) + C(\text{Interference}) + C(\text{Quality of Service}) + C(\text{Total Delay}) \quad (3.1)$$

Equation 0.1: General UCAN Equation

Where $C(x,y)$ is the Cost Function

However, considering that the research focuses only on power optimisation for the time being, the idle power parameters should therefore be:

$$C(\text{Power}) = C_1 * R(x, y) * d^\alpha(x, y) \quad (3.2)$$

Equation 0.2: Power Equation

Where:

C_1 = is a constant value to be changed for bit rate

R = is the request rate

d = is the distance between the two terminals and

α = is the positive number based on propagation characteristic (usually between 2 – 4)

The above power equation 2 can be implemented using [98] approach of transmitting power, bit rate, choice of modulation technique and ignoring the effect of interference in the communication model. Below is the full detail of the techniques in terms of transmission:

- Interference with respect to different modulation techniques: transmit even outside region regardless of interference
- Bit rate allocation: bit rate is at range of 1 – 18Mbps
- Modulation techniques to be used: Pulse Position Modulation (PPM) as UWB signal

- Transmitting power: full power during transmission
- Interference with other narrowband systems: the code channel is capable of adapting the transmission medium by ignoring interference and adjusting to the required bit rate for transmission

Signal Transmission:

With respect to signal transmission, [98] approach is also adequate to determine the exact signal transmission where the total time (T) taken for the transmission, chips (c) and short duration time in nano seconds (T_c) can be calculated as stated below in the equation 3.3:

$$Time(T) = \frac{Chips(c)}{Short\ duration\ (in\ Nano\ seconds\ (T_c))} \quad (3.3)$$

Equation 0.3: Signal Transmission Equation

However, the total time taken for the whole transmission can be presented in the form of frames.

The overall transmission can be determined by the use of a random number generator which can be in the form of the below equation 3.4:

$$x_{n+1} = [ax_n](Mod\ m) \quad (3.4)$$

Equation 0.4: Random Number Generator

To achieve maximum utilisation of power in the transmission in order to optimise the performance of MAC, the frame size, or PRP, must be large. Le Boudec, et al. [98] suggested the PRP of 280 which can be increased or decreased depending on the size of the network.

Modulation:

With regards to modulation techniques to be used for the proposed MAC, UWB transmission supports both impulse radio (IR) and multi carrier techniques. The research focuses on using Impulse Radio (IR-UWB) transmission to design the UWB-MAC protocol in MANET for optimum power consumption. The reason for using IR-UWB is because it consumes less energy compared to MC-UWB. IR-UWB has unique properties like rise time, pulse width and Pulse Repetition Frequency (PRF). In addition, IR-UWB is short range, supports low complexity hardware and consumes less power. The proposed UWB-MAC MANET would be based on the spectrum properties below:

Table 0.5: Spectrum Properties

S/N	Entity	Value
1	Range	3.1 – 10 GHz and is divided into 11 channels
2	Bandwidth	499.2MHz for each channel
3	PHY specification	IR
4	Modulation Scheme	either on-off keying (OOK) or Different Binary Phase Shift Keying (DBPSK)

Mobility:

Mobility is another challenging factor after high energy consumption by the mobile nodes in MANET. The proposed MAC protocol will also address the issue of mobility because of the dynamic nature of MANET. Designing a MAC protocol based on the above approach will also solve part of the mobility issues in MANET without considering a specific technique that will solve mobility.

Throughput:

As the research is focused towards using the wireless Personal Area Network (PAN) protocol of said IEEE 802.15.3 for optimisation with regard to power saving, throughput optimisation also has to be regarded to help achieve the desired goal. Le Boudec, et al. [98] approach does not consider throughput as an entity for implementation but, if supplemented, it may serve as an added advantage. The following entities have to be controlled in order to achieve maximum throughput in MANET for the proposed MAC protocol:

- i. Signal-to-Noise Ratio (SNR)
- ii. Bandwidth availability
- iii. Hardware limitation
- iv. Network Allocation Vector (NAV)

The above entities can be measured directly using the Time Window (T_w) approach.

Le Boudec, et al. [98] approach considered the first three entities which are SNR, bandwidth availability and hardware limitation. Our proposed MAC protocol will also incorporate the use of the NAV entity in order to boost the performance of the protocol and yield high throughput for better quality of service. NAV allocation in designing a MAC protocol can either be RTS/CTS/DATA techniques or allocating numerical values to the frame header. RTS/CTS/DATA technique is a virtual way of allocating NAV while the numerical method is physical. Both methods support auto update which is accepted during implementation.

Finally, the proposed MAC will constitute the characteristics below:

- Adapt to the varying channel
- Support medium mobility level
- Suitability for UWB and MANET

- Simple design as compared to other approaches in terms of power utilisation as if there is no power control used

In summary, energy can be optimised in the proposed MANET UWB-MAC through the following steps:

- i. Maximum power can be used at the transmission stage instead of the receiving stage
- ii. Ignoring interference outside the exclusive region
- iii. Finally, the exclusive region will always be in a temporal mode

3.13 UWB Transmission Techniques at the MAC Layer

The existence of power saving techniques at the MAC layer is a vital issue due to the fact that it constitutes one of the basic layers at which initialisation of communication is instigated. However, among the contemporary techniques are sleeping scheduling techniques, awareness of battery usage at the MAC layer, which is sometimes referred to as the Battery Aware MAC protocol (BAMAC). Different transmission techniques are present at the MAC layers using UWB systems due to their momentous advantage to save energy in the system. The techniques include using Time-hopping Impulse Radio (TH-IR) [99] in conjunction with directional antenna systems for the improvisation of energy in WSN.

3.14 Advantages of using Directional Antennas in MANET to save Energy

The advantages of using directional antennas in MANET instead of the default antenna system, that is, the omni-directional system, are enormous. However, Figure 3.6 is an example which illustrates the motivation behind using the directional system.

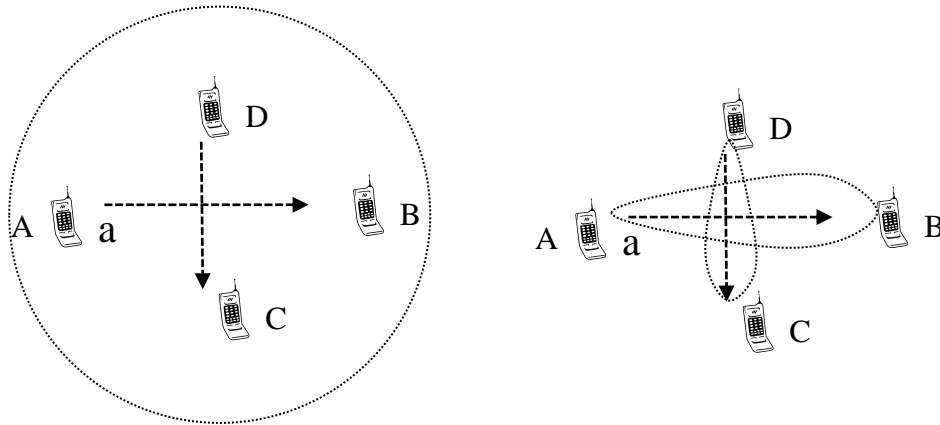

Figure 0.6: Omni and Directional System

(i) Omni Directional mode

(ii) Directional mode

Some of the advantages are spatial reuse factor, energy saving and extending range in terms of location finding which are explained in detail below.

- i. **Energy saving with directional antennas:** In Figure 2.6 (ii), communication between nodes A/B and D/C will strengthen the flow of communication even when the signal is weak due to the directivity of the transmission and the high reception gain of the antenna. Therefore, energy required for the nodes to communicate is less, unlike in Figure 2.6 (i) which uses the Omni system. In addition, it will reduce the power required for communication with a maximum distance d of communication covered due to the high gain of antenna use [100]. Consequently, the use of directional antenna in MANET and adapting the use of minimum power in transmission reception will save energy significantly.
- ii. **Spatial reuse of the channel:** The bandwidth utilisation in Figure 2.6 (ii) and Figure 2.6 (i) cannot be the same. Nodes in Figure 2.6 (ii) utilise entirely its bandwidth while communicating due to the directivity and the beam will be focused from sender to receive instead of spreading it. In Figure 2.6 (i), interference may occur due to the Omni system used. Multiple transmission will also occur in (ii)

between the nodes because of the directivity, unlike in the Omni system where it must be single transmission to avoid collision. These features of using directional antennae in MANET will increase the spatial reuse factor in the system.

- iii. **Extending range of communication:** As the beam is focusing towards a specific direction in (ii), so also the range of communication increases unlike in (i) where the beam was unfocused. Focused beams travelled a larger distance compared to unfocused beams [99]. Bhusal, et al. [101] quantified that when using directional antennas, it requires less energy/power to reach a maximum distance than when using omni- directional antennas.

With the enormous advantages of using directional antennas, it is quite motivating to implement the use of the system in MANET and other networking setups like Body Area Network and the like.

3.15 Basic Assumption

We used analytical and simulation methods in the implementation of the study. The study assumed that all mobile nodes are homogenous and may be operated with the same energy level and with the same speed level. Based on that, it is easy to achieve this in a simulation environment and analytical approach, but not in a real life-time scenario because of its complexity and time constraint.

3.16 Summary of review

So far, reviews have been undertaken on MANETs in general, UWB technology, MANET MAC protocols and their different types, UWB-MAC, MANET applications, UWB applications and different power algorithms that have been proposed in past papers. It has been observed that centralised MAC protocols are most suitable for conserving power in MANET

due to their control mode of operation. In addition, from the different power management techniques reviewed in this study, we observed that power conservation techniques in MANET are generally implemented at different levels: at the MAC layer, by tuning transmit power or by using optimised power using full UWB technology.

Applying power, the management technique at the MAC layer is often done by carefully sending the receiver into a sleep mode, or by using a transmitter with adaptable output power and selecting routes that require many short hops, instead of a few longer hops. Furthermore, applying the power management technique at node levels reduced energy consumption but power is consumed when mobile nodes are in sleep mode and also while trying to wake from sleep. In addition, applying power management techniques by controlling transmit power can be quite complicated because the choice of power level can affect other performances in MANET such as delay, throughput, increase in interference and so on.

Based on the fact that most research studies reviewed were based on networks with narrow band technology (which can be quite complicated in complex networks in terms of power transmission and data transmission when compared to using UWB technology), this project focused on power conservation techniques in a network with full consideration of UWB standards.

After continually reviewing the literature, we are using the concept of directional antennas in order to accomplish tasks as stated in the design parameters. With the enormous advantages of using directional antennas in MANET and integrating UWB technology, it will be sufficient to exploit different concepts of conserving energy in the network, particularly at the MAC protocol stack.

3.17 Preliminary testing of the proposed protocol using QualNet simulator

Before presenting the analytical model in the next chapter, we used a simulation approach to test the proposed model based on some assumptions and some selected parameters with justifications. The analysis was made by creating scenarios based on existing models in QualNet for proper implementation of the proposed protocol.

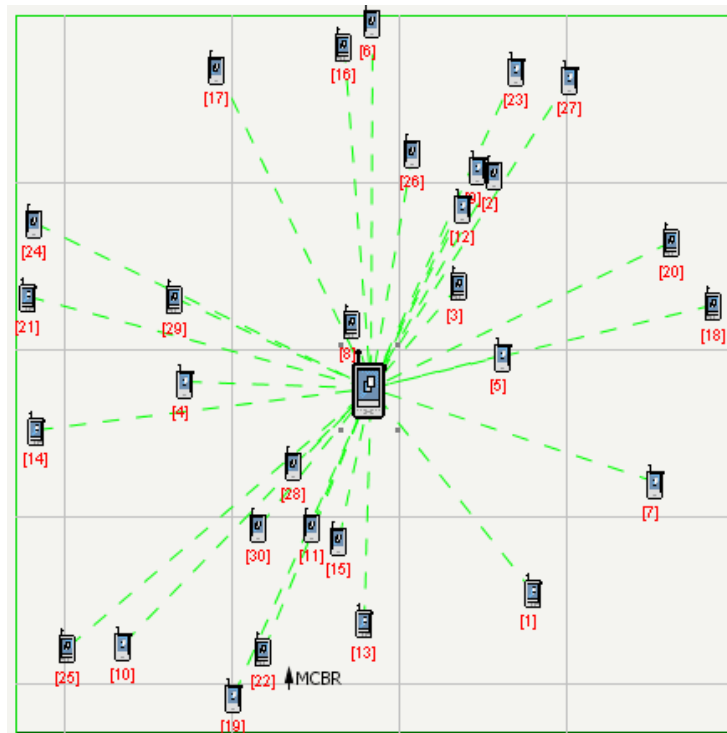

Figure 0.7: Scenario Design for Preliminary Testing of the Proposed Model

3.18 Analysis of the Proposed UWB-MAC with Simulator

Considering MANET as a multi-hop connection network and the ineffectiveness of using omni-directional antennas as default antennas for transmission and reception purposes, we feel that there is a need to come up with a different strategy for transmitting and receiving patterns using directional antennas in order to save energy.

Here we tested the modified model using QualNet Simulator to analyse its outcome using some metrics as described in Tables 3.6 and 3.7. With this analysis, it was expected that potential

challenges would be figured out relative to the proposed UWB-MAC and the guidance of future solution paths. The analysis will also demonstrate how the proposed protocol will interact with other layers of the network: specifically, the network layer. Different scenarios are developed with the default MAC protocol using the Omni system, the UCAN strategy and the proposed UWB-MAC in order to justify the need for the research study.

Table 0.6: Simulation Parameters for Omni System

Omni system		
S/N	Parameters	Values
1	Number of Nodes	30
2	Antenna type	Omni
3.	MAC	IEEE802.15.3
4	Antenna range	200ms
5.	Mobility	None
6.	Propagation channel frequency	$9.14 \cdot 10^8$ Hz
7.	Path loss model	Two ray
8.	Transmission power	24.5dB
9.	Receiver sensitivity	-68.1dBm
10.	Routing Protocol	TORA
11.	Transport protocol	TCP

Table 0.7: Simulation Parameters for UCAN approach and Proposed MAC

UCAN and Modified system		
S/N	Parameters	Values
1	Number of Nodes	30
2	Antenna type	Steerable
3.	MAC	IEEE802.15.3
4	Antenna range	200ms
5.	Mobility	None
6.	Propagation channel frequency	$9.14 \cdot 10^8$ Hz
7.	Path loss model	Two ray
8.	Transmission power	24.5dB
9.	Receiver sensitivity	-68.1dBm
10.	Routing Protocol	TORA
11.	Transport protocol	TCP
12.	Direction Gain	10.0db
13.	Directional NAV Delta angle	22.5degrees

Due to QualNet's drawbacks and time constraints, we have implemented our model based on some assumptions. Three scenarios were created based on OmniSys, UCAN approach and the proposed UWB-MAC and parameters were inserted into the scenarios as in Tables 3.6 and 3.7. A total of 30 nodes was considered as the density of the network with an area of 200 x 200 metres in an ad hoc environment as shown in Figure 3.7. Mobility is not an issue given that the existing model covers the issue of mobility and it was proven in Section 3.9. The distance between mobile nodes is static and is 10 meters at the furthest.

The directional angle of 22.5° for the steerable antenna (directional NAV delta angle) was adopted based on the proving analysis conducted in [102]. At that angle, there is less interference due to other frequencies and it is the smallest angle between the edges of the nodes. Analysis was conducted by [102] with respect to the specific angle of transmission in order to yield maximum goodput and different angles were tested.

3.19 Performance Evaluation

The used of batch experimental mode to run the scenario with multiple parameters in order to obtain results that defined the number of packets dropped, energy consumed at the MAC layer, total battery charge, percentage of time to transmit and the goodput. The batch experimental mode will allow the execution of several experiment at once which may leads to dynamic statistic, defining number of seeds per simulation, node positioning, traffic definition, network protocols and parallel settings like terrain. It will allow quick collection of graphs and generate several types of convenient graphical comparison of results and statistical values. The batch experimental mode has the capability of generating application-neutral ASCII data files which can be imported into different graphical applications like excel and the like.

Scenarios were created based on the parameters set in table 3.6 and 3.7 and number of different iterations were made in order to produce some starts files that can be used to analyse the result

obtain. One of the responsibilities of a MAC protocol in a network is to make sure that transmission and reception between nodes is successful without collision occurring in the medium, that is, with total avoidance of collision in the network. Whenever collisions occur, packets may drop and communication may halt, re-transmission may occur and the time of transmission may increase which may cause the goodput to drop. In a real time application in an ad hoc network, packets dropped constitute a factor that affects QoS in terms of energy consumption.

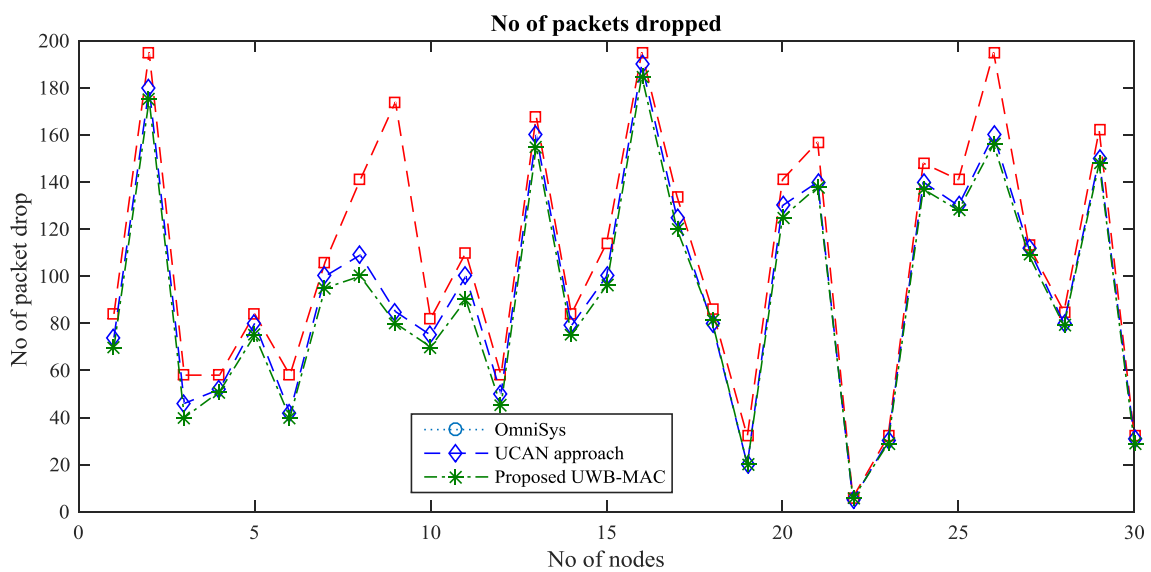

Figure 0.8: Packet Dropped Analysis

Packet drop occurs when packets are transmitted within a time window but not received by the intended receiver. This may occur as a result of traffic patterns, the environmental factor and topology.

The analysis is concentrated on the two basic layers, that is, the physical and MAC layers to monitor the number of packets dropped considering the OmniSys, UCAN approach and the proposed UWB-MAC. In Figure 3.7, the variation of packets dropped at the MAC layers is not great. We used TORA as a hybrid routing protocol to enable the proposed protocol to perform at its best with respect to higher simulation times and for proper adjustment in the routing table.

TORA uses both methodologies, that is, active and proactive methods of routing which show that the proposed UWB-MAC performs better. The packets dropped due to simulation time and increasing number of nodes were consistent in a zig-zag motion. Likewise, variation in frequencies also plays a significant factor in decreasing the amount of packets in the proposed UWB-MAC.

The total packets dropped by OmniSys MAC is 3233Mbps, total packets dropped by UCAN approach is 2855Mbps and total packets dropped by the proposed UWB-MAC is 2746.5Mbps. Considering the proposed UWB-MAC performed best, the system still needs to be validated using the analytical approach in section 3.5.

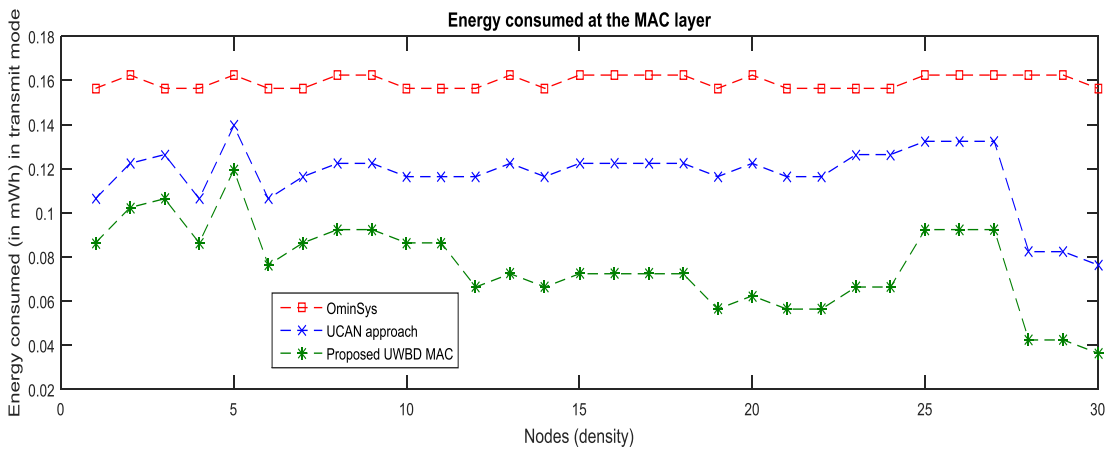

Figure 0.9: Energy consumed at the MAC Layer

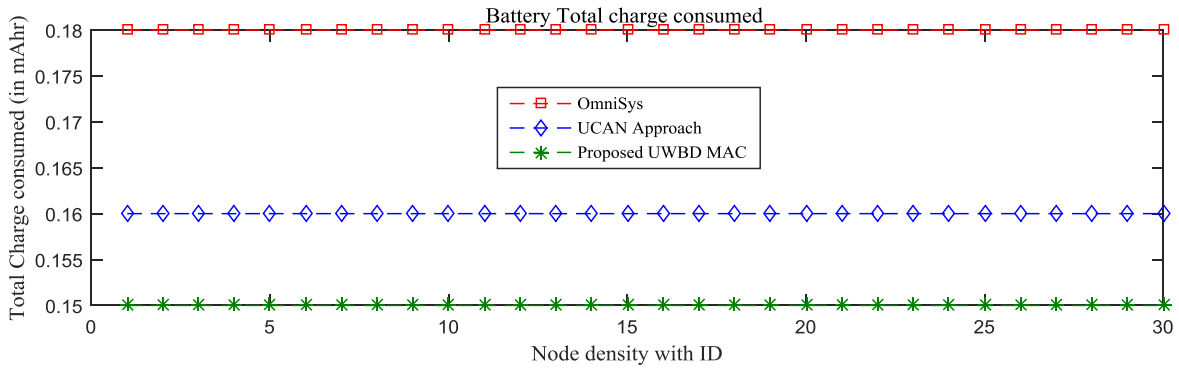

Figure 0.10: Total Battery Charge Consumed

Figures 3.8 and 3.9 described the energy consumed at the MAC layer and the total battery charge respectively. The simulation results show that the proposed model conserved energy more than the original model parameters. The battery charge of the nodes rose up to 0.18mAh which is high, compared to the UCAN model which demonstrates 0.16mAh. This saves about 0.02mAh and is a significant value to be considered. This recorded increase will save the nodes more life to participate in the network. The proposed UWB-MACs demonstrate more in saving another 0.01mAh totalling about 0.03mAh compared to the original Omni system model. 0.15mAh is the code point of the proposed UWB-MAC and this is a significant number to be reflected.

The energy consumed at the MAC layer in continuous transmit mode in Figure 3.7, with respect to density of the network, was 0.16mWh downcast to 0.022mWh. The original model recorded a maximum value of 0.162mWh which is higher than the UCAN model and likewise, higher than the proposed UWB-MAC.

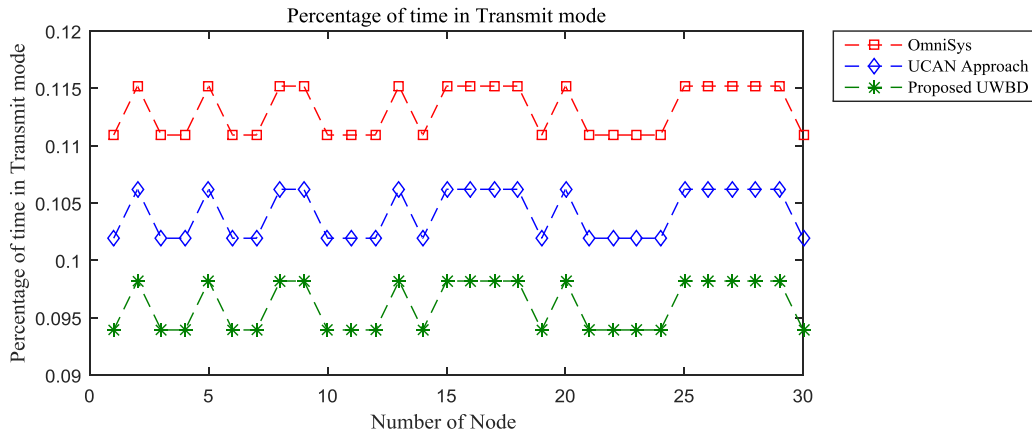

Figure 3.11: Percentage of Transmitting Time

The percentage of time in continuous transmission mode has to do with time to transmit, receive, idle and sleep of the MAC protocol. All these categories were combined to form a single entity for easy analysis although in some cases, they are independent of each other. With regards to this analysis, we considered it as a single entity because our interest is only in saving energy at the MAC layer without giving emphasis to other layers which may also be considered in the future. The total percentage of continuous time of transmission mode of the proposed UWB-MAC recorded less than the original MAC and the UCAN model.

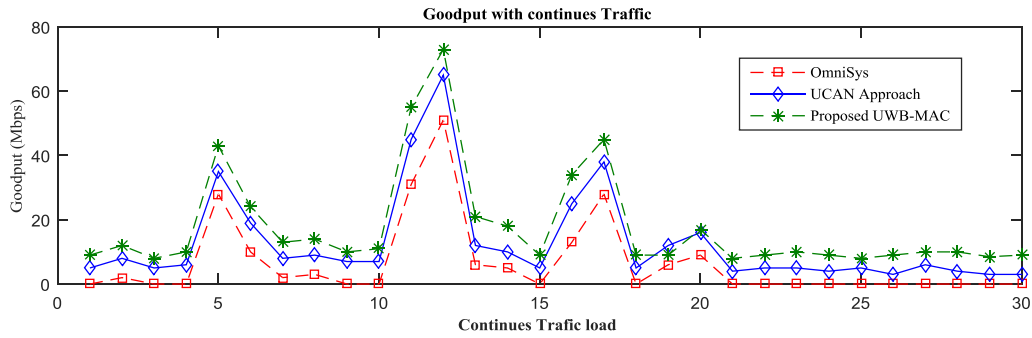

Figure 0.11: Goodput Comparison

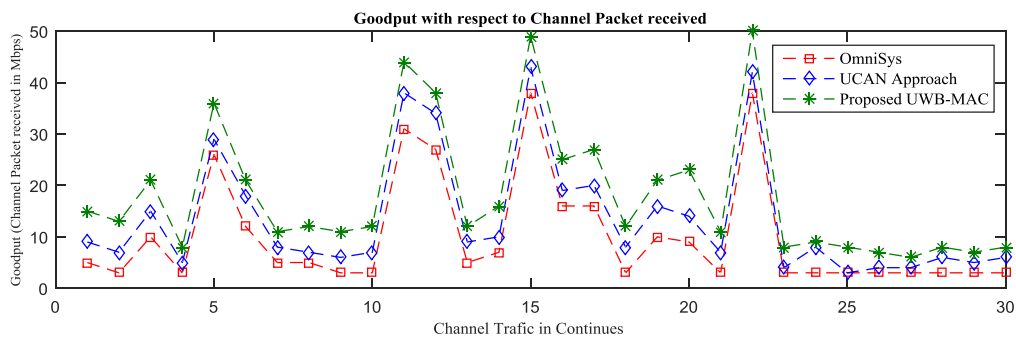

Figure 0.12: Goodput Comparison

Figures 3.12 and 3.13 described the goodput of the network in terms of MAC channel traffic and the traffic load in continuous mode. The three different scenarios were plotted based on the prescribed parameters and the results indicate that the proposed UWB-MAC performed better against the original version and the UCAN approach due to directivity. The goodput of the proposed MAC is a little bit higher than the UCAN approach with a significant increase in number. Moreover, the performance of the MAC protocol, with respect to application, is subject to the agility of the application. Therefore, resource intensive applications like VoIP, cloud storage, virtual desktop and AirPrint/AirPlay should also be tested. We predict that even with the heavy application, it is only the two original protocols that would be affected because of the Omni system in place. The proposed UWB-MAC will survive because of the directivity system in place. The proposed UWB-MAC protocol may have some resulting issues with other

layers of the network, especially the immediate layer which is the network stack and thereby, it may also have an effect on the total goodput of the proposed system. Solving these problems will be a task for the future using the analytical approach.

3.20 Summary of Analysis

The aim of analysing the protocols is to understand the behaviour of the protocols in a real-life situation in terms of communicating between nodes and to understand the features of directional systems with UWB properties in MANET. Subsequently, the aim is to pinpoint the sources of inefficiency in order to proffer a solution when developing the analytical model.

The analysis shows that there is significant improvement in goodput and energy consumption both for the battery charge and energy model. We conclude that more techniques should be applied at the MAC layer for the effective use of directional antennas. Nevertheless, we observed that the angle of transmission plays a significant role in utilizing the channel capacity in terms of minimising the transmission time. The study also helps in identifying the full characteristics of directional systems in MANET with UWB properties. Lastly, we observed that there is good improvement in our proposed UWB-MAC compared to ordinary omni-directional systems and the UCAN approach. Table 4.3 exhibits the summary performance of the three protocols.

Table 0.8: Summary of Analysis

MAC protocols	No of packet drooped	Energy consumed at MAC Layer (mWh)	Total battery charge consumed (mAh)	Percentage of time in transmit mode	Goodput traffic load (Mbps)	Goodput channel traffic (Mbps)
OmniSys	3233	4.8	5.4	3.4	194	302
UCAN approach	2855	3.5	4.8	3.1	384	411
Proposed UWB-MAC	2746.5	2.3	4.5	2.9	534.5	549

As the research is on-going, it is envisaged that greater benefits of the improved model would be unveiled and articulated. Extended study and analysis of the model capabilities with respect to other areas will be undertaken in a bid to grasp better understanding of the full package of the model. Clearly, further work needs to be done. Table 3.8 summarises the outcome of the analysis: the proposed UWB-MAC performs better compared to the original versions.

Chapter Four

4.0 Design

4.0.1 UWB-MAC Design with Directional Antenna

4.0.2 Tailoring MAC to Directional Systems in MANET

MANET in general uses omni-directional antennas that lead to several factors contributing to network inefficiency. As stated earlier, the implementation of the research study is centred on improvement of an existing MAC protocol. Based on the analysis conducted so far on different MANET MAC protocols, be it carrier sensing or without carrier sensing, IEEE 802.15.3 has been selected as the entity of study.

The UCAN power equation [40] clearly states that power relies on certain constraints and a constant of proportionality. The model is represented as the product of the constraint variables and constant although with potentially hidden limitations. However, a structural review of the model has become necessary due to the openness of the systems.

$$C(\text{Power}) = C_1 \cdot R(x,y) \cdot d^{\alpha}(x,y) \quad (4.0)$$

Equation 4.0: UCAN Equation[97]

One of the objectives for this research work is the modification of an existing MAC protocol in order to optimise energy consumption in MANETs. This is targeted on the UCAN power model by introducing a new constraint that could potentially optimise the system. The model modification will aid the optimisation of power consumption in the network when considering the use of a directional antenna in the network rather than the traditional omni-directional antenna. This strategy is channelled strictly on a specific MAC protocol that bears similar properties to UWB technology [103].

MAC protocols, designed with full attributes of omni-directional antenna characteristics, are not suitable for work within a directional environment. Therefore, to achieve the full benefit of spatial reuse and a high range of communication, the existing IEEE 802.15.3 needs a redesign.

4.1 Proposed Model Constraints

Considering the relationship between all the layers of the network (as in the way communication flows between the stacks and definitely with the changes made at the MAC layer, in terms of constraining the nodes to act using directional antennas, and the new properties added with respect to UWB property), it is expected that some issues will arise which may be deliberated before the end of the research study. Our focus now is to ensure that our proposed UWB MAC protocol is working, irrespective of challenges that will occur after implementation. Our aim is to save energy using UWB systems at the MAC layer using directional antennas. Whatever issues might arise after implementation will be considered as a challenge and solutions may be proposed.

Consequently, it is expected that every research study is destined to predict some challenges that may arise before, during and after implementation. Some of the challenges of integrating UWB at the MAC layer of the network have been solved or proposed by other scholars. The potential for previously known challenges which may bedevil our proposed protocol after implementation has not been ruled out. Functional issues surrounding the effect of mobility, deafness, head line blocking, virtual carrier sensing issues, changes in routing tables due to inconsistency in movement, hidden terminal problems, interference caused by higher gain and so forth would be looked out for.

4.2 Propose Model Modification

The initial model was based on some selective entities that form the system and it was strictly based on the traffic that has been used to analyse the performance of the model. The traffic model is detailed in Section 4.3.1 and the way in which the model is intended to be modified in order to come up with optimum performance of the system, as required in the objective of the study.

4.2.1 Traffic Modelling

The traffic model to be sighted in this research study is to adapt and modify the existing model packets. Directional antennas should be restricted in conjunction with the defined parameters (Constant Bit Rate: CBR, Number of Request: R, and distance between the nodes with exponential of the propagation channel: d^α). To achieve good performance of the network with respect to controlling power, optimising metrics like range, network capacity, geographic coverage and link data rate will support in simplifying the dispute. Brief explanations of these variables are as follows:

i. Number of Request (R):

Number of requests in a network can also be expressed as density of the network which is the total number of edges or vertices per square metre. The edges define the total links in a given network accessing a particular channel or the degree of each node in the network, while the vertices describe the total number of nodes in the network. The density of a network defines how robust and rudimentary the network is. Figure 3.1 describes the density structure of a network with increasing size and shape order.

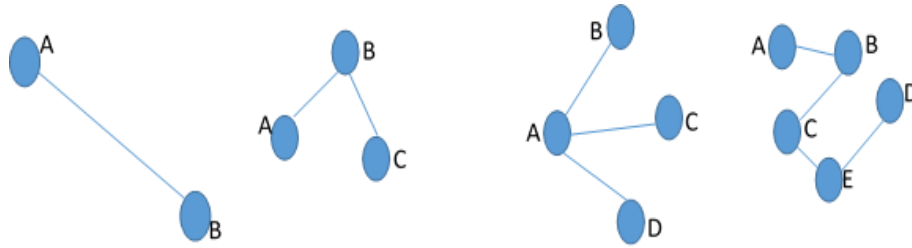
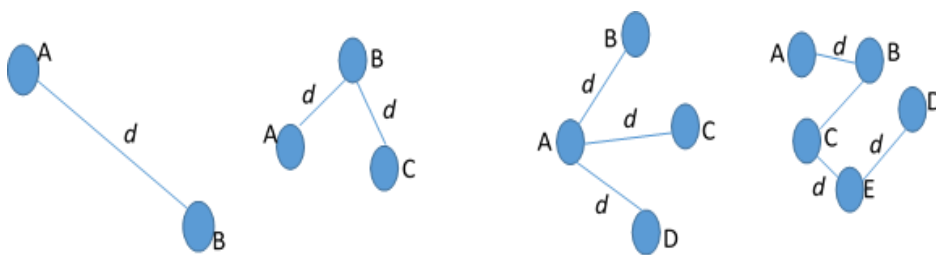

Figure 0.1: Density Structure of a Network

ii. Distance between Nodes:

Distance between nodes, working by graph theory in relation to wireless devices participating within a specified region, can be expressed using eccentricity, radius and the central vertex of the graph. Combining these three parameters will clearly estimate the distance between nodes in a given wireless network. However, in a real sense, distance between wireless devices (nodes) - nodes A and B - as the shortest path for communication between A and B has been defined. This is also referred to as the estimated length in hops between A and B for successful communication.



iii. Propagation Channel:

Bearing in mind that the proposed UWB-MAC protocol is a MIMO system where multi-path is noticeable, then propagation must be dynamic due to the instability of nodes in the network. One of the objectives of the study is to conserve energy at the MAC layer using

the UWB system. The propagation channel is among the parameters to be considered. Therefore, a generic value is proposed for use as specified by IEEE 802.15.3 group[104].

Energy conservation is the key focus of this research study. It explores how to save energy in the network to the greatest possible capacity, building on an earlier technique adopted in [7] for identifying the packets to be considered when drawing results. Conclusions will be centred on the following properties:

- i. MAC type
- ii. Channel
- iii. Propagation
- iv. Antenna
- v. Radio frequency
- vi. Initial energy
- vii. Idle power
- viii. Receiving power
- ix. Transition power
- x. Sleep power
- xi. Transmission time

The framework of the existing model is presented in the Figure below.

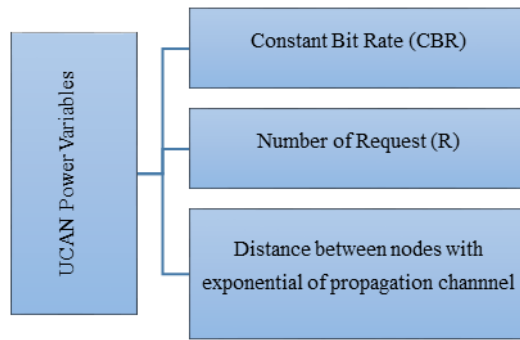

Figure 0.2: Existing Model Frame Work

Note, the above framework assumes the use of omni-directional antennas for signal transmission, whose variable constraint is significantly not represented in the model. Introducing the left-out antenna constraint into the framework will hypothetically not alter its initial meaning and outcome, but would rather increase healthier understanding, while making clearer the requisite characteristics that make up the power model/framework. The modified version of the model will thus be represented as follows:

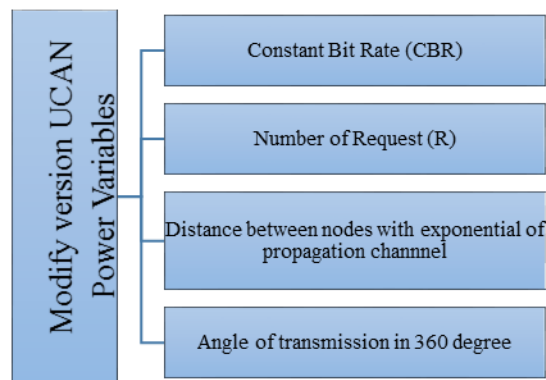

Figure 0.3: Modified Frame Work

4.2.2 Model Formulation

Given that IEEE 802.15.3 standard is the target for re-modification, there is a need to specify the modulation techniques and the data rate at which the system transmits in order to

comprehend the functionality of the MAC protocol as designed by the group. The group adopted Multiband Orthogonal Frequency Division Multiplexing (MB-OFDM) in which the signal will be transmitted using a Frequency Hopping (FH) scheme as in Figure 4.4. The data rate at which the system transmits is supported by seven different ranges from 55 to 480Mbit [105] and among the ranges, a mandatory portion of 200Mbit was selected for implementation.

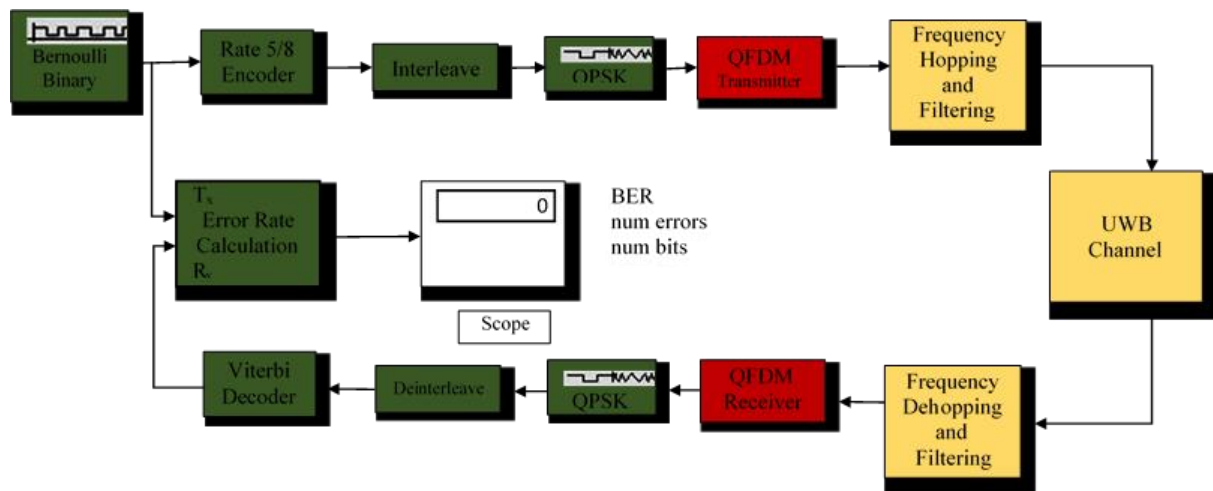

Figure 0.4: Orthogonal Frequency Division Multiplexing (MB-OFDM) Model

To design a UWB MAC for MANET requires basic theoretical knowledge on computation and a definition of clear parameters for the antenna system for the utilisation of the channel, especially when considering directional antennas. Antenna systems specifically deal with three fundamental design parameters which are performance, ranges and direction used (angle) [99]. Therefore, energy, location and distance may be defined as major sub-parameters to be considered in designing UWB MAC with directional antennas. It will be recalled that the aim here is to conserve as much energy in the system using UWB through a modified transmission angle-defined MAC protocol (IEEE.802.15.3).

Antenna sends radio waves from transmitter to a receiving end using electromagnetic wave flowing into a transmitting antenna which generate electrons by vibrating up and down and

produces radio waves. These radio waves travels through the air with the help of a speed light and searching for connectivity with receiving ends. The arriving waves makes electrons vibrates for identification and notification which produces an electric current in the receiver and create the original signal. Antennas work in a dual craving mode for transmission and (or) reception and also mob the same parameters for performance, except in power and overload restriction where directional antennas use less power in both transmission and reception [106]. Communication between two antenna (transmitting and receiving) occurs by the line sight, the ionosphere and the ground waves.

Using partial representation, power (P) assumes the dependent variable position, while Number of Request (R), and distance between the node with exponential of propagation channel (d^α) assumes the independent variables position. Adopting rational techniques, a direct proportionality relationship is described between the dependent variable P and the set of independent variables R and d^α , and represented thus: $P \propto R$ and $P \propto d^\alpha$.

Hence, eliminating the proportionality symbol and introducing the constant of proportionality, the relationships are interpreted as:

$$P = C_1 R \tag{4.1}$$

Equation 0.1: Power with respect to Density

$$P = C_2 d^\alpha \tag{4.2}$$

Equation 0.2: Power with respect to Distance

Since the constant of proportionality is unchanged, it is assumed that: $C_1 = C_2 = C$ such that:

$$P = C_1 R d^\alpha \quad (4.3)$$

Equation 0.3: Combining density and distance with constant C

However, power consumed on transmitting requests may vary from the power consumed when transmitting information with regards to the distance between the nodes with the exponential of propagation channel. It follows that: $(P = C_1 R) \neq (P = C_2 d^\alpha)$, i.e. *Equation (3.1) \neq Equation (3.2)*. Therefore, since the system in question is open, modification is proposed with the introduction of a new constraint to the power function, assuming that the typical UCAN approach adopts omni-directional antennas, which is construed to cover an all-round transmission (i.e. 360^0 angle of transmission: see Figure 3.4). It is hypothesized that the rate of power consumption would vary with a variation in the angle transmission value of an antenna. For instance, it is thought that the effective power consumed in running the signal transmission omni-directionally (360^0) would potentially reduce proportionately with a reduction in the angle transmission, that is, $<360^0$. In particular, it could reduce by half if the angle transmission also reduces by half. It could be thus theorized that power consumed (P) is proportional to angle transmission (T_{XA}), that is: $P \propto T_{XA}$, and:

$$P = C_1 T_{XA} \quad (4.4)$$

Equation 0.4: Transmission with Directivity

Combining equations (3.1), (3.2), (3.3) and (3.4), the power consumed: P , is represented as the product of all the independent variables (transmitting requests: R , distance between nodes: d^α and angle transmission: T_{XA}) in the system provided that the range of transmission is not exceeded. This essentially offers a modification of the initial power function (model) to:

$$P = CRd^{\alpha}T_{XA} \quad (4.5)$$

Equation 0.5: New model of Directivity

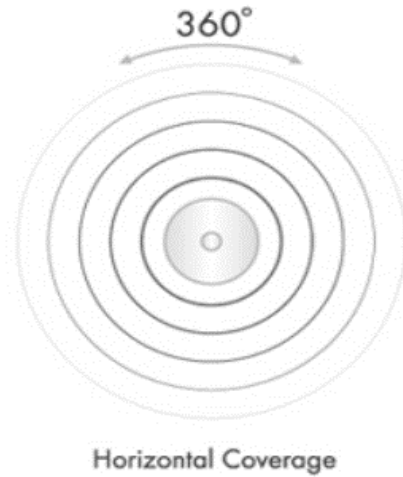

Figure 0.5: Transmission with Omni[107]

Note:

Equations (3.4) and (3.5) would be considered the same *IF AND ONLY IF* the system transmits at exactly 360^0 , that is, using omni-directional antennas ($P = CRd^{\alpha}T_{XA}$) = ($P = CRd^{\alpha}$): *ONLY IF* $T_{XA} = 360^0$).

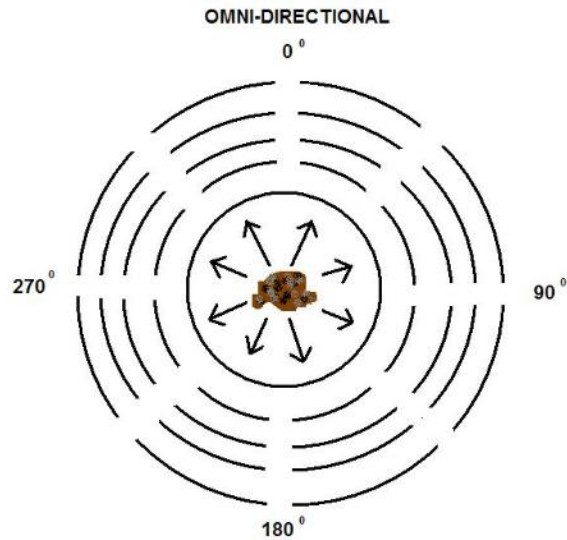

Figure 0.6: Omni Directional with sectors[107]

It is argued that the power consumed for transmission using omni-directional antennas will potentially differ from that used for non-omni-directional or directional antennas, in which case, the transmission angle would be less than 360° . As the transmission angle continues to decrease along the transmission line, the power needed to run such transmissions would potentially reduce. Accordingly, the lesser the angle of transmission degree, the less power would be consumed in the network. If T_{XA} is less than 360° , then it is short of an omni-propagation system and considerably short of a directional system.

Therefore, T_{XA} will be tested based on different ratios of directional transmission as shown in the Figure 4.6 below.

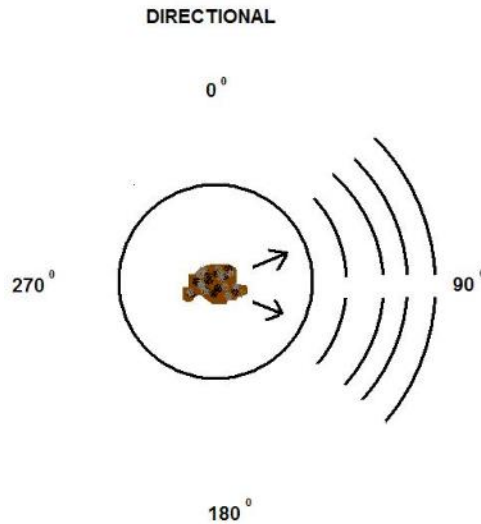

Figure 0.7: Directional Transmission

The derived model for potentially determining the power consumption with respect to the type or angle of transmission covered by an antenna is depicted as equation 4.5. (i.e., $P = CRd^\alpha T_{XA}$).

4.3 Parameters consideration and model formulation

It is assumed that the broved entities like distance, constant bit rate, density of the network are partially constant, therefore, working on the directivity of the transmission and reception at the physical layer with the highest mandatory data rate of 200Mbit and transmitting, using frequency-hopping. IEEE802.15.3 group is Multiband-OFDM which is similar to IEEE802.11a/g standard, and it was adapted for implementation as the UWB model. Table 4.2 demonstrates the basic parameters being considered for the successful implementation of a re-modified version of the MAC protocol. However, our proposed model will apprehend the end-to-end physical layer (PHY) as stated in [5]. The model properties for consideration include: RF transmission bandwidth, frequency-hopping, error correction coding, code rate, modulation, OFDM transmission, payload symbols per OFDM symbol, time spreading and finally, the multi-path resistance from cyclic prefix.

Table 0.1: Multiband-OFDM Table System Characteristic

PROPERTY	RATE
RF transmission bandwidth	528 MHz
Frequency hopping ('Mode 1 device')	3 sub-bands (3.43, 3.96, 4.49 GHz centers)
Error-correction coding	Convolutional with puncturing
Code rate	$R = 5/8$
Modulation	Quaternary Phase Shift Keying (QPSK)
OFDM transmission	128-point IFFT, zero-DC
Payload symbols per OFDM symbol	100
Time spreading	2x (across frequency hops)
Multipath resistance from prefix	60ns

4.3.1 Model Validation

Focusing on signal transmission/reception to a specific direction with a constant interval between nodes in order to save energy, different techniques may be used for validating the suitability of the model in place. A simulation approach would have been a good approach, but for the inability to detect potentially debilitating issues by the simulator. An analytical approach would be able to resolve that, hence its choice for validating the proposed model.

The reason for using analytical approach in the first place is because, analytical methods is a mathematical abstraction which may be extended to solve various working conditions. With analytical approach, an exact solution of a problem can be derived and a result can be obtained in various conditions. An interesting thing about analytical approach is that, it will provide a generic way to get performance results which may yield various conditions through a mathematical formulation. With analytical approach, one may determine the accuracy of the model by using some numerical values to test the validity of the system. In case of any uncertainties, this can be handled through a stochastic approach to account for modelling and measurement process.

Beamforming techniques, or spatial filtering, is a known technique that could be useful because of the angle of transmission/reception constraint in the UWB system. The phase angle pointing towards a specific direction is a function of the frequency and the energy required for the transmission is not like when using narrowband systems (see equation 4.3). Equation 3 is an open model, thus, the assumption is that omni-directional systems exist and are in use. Hence, the transmission follows as defined by the original model without accounting for effect of power/energy in the channel. Nonetheless, as the direction of transmission/reception is specified, so are the changes in channel properties and the angle definition changes. The UWB system may conserve energy in MANET through the MAC protocol as direction of transmission is also the function of frequency. The UWB system has a Fractional Bandwidth (FB) of the signal of 20 – 25% which can be in the form below.

$$FB = \frac{fh - fl}{(fh + fl)/2} \quad (4.6)$$

Equation 0.6: UWB Equation

Note that distance is a key parameter that affects power consumption in the system and is a function of frequency. Assuming distance between nodes remains uniform and constant, then distance: d , could be expressed as:

$$d = \frac{\alpha}{2fh} \quad (4.7)$$

Equation 0.7: Distance with Constant Propagation

Where, α is the rate of propagation with respect to distance, d , and the maximum frequency used.

$$P = CR \left(\frac{\alpha}{2fh} \right)^\alpha T_{xA} \quad (4.8)$$

Equation 0.8: Distance with Constant Propagation and Directivity

Note: Angle of Transmission:

The resulting effect of changing the value of transmission angle may affect the prevailing model because the direction of transmission is significant and must be represented. To achieve that, the study seeks to devise a means for alternating values, with regards to variables stated in the model, and to observe the resulting effect at the end of the analysis.

Meanwhile, the main focus of the design at the moment is at the Physical layer, therefore it is useless to discover how to enhance the MAC protocol through exploring the physical characteristics of UWB systems in MANET for high data efficiency. Among the existing MAC protocols for UWB systems, IEEE802.15.3 standard is the contiguous version that has UWB features but, the unique features of UWB were not specific and its demand for re-modification to be efficient for UWB MANET.

4.4 Analytical Model

In this section, presentation on how to evaluate the directivity optimally and the energy consumed analytically. In an ad hoc network, the best way to prove the validity of a model is to use the available network simulator that supports the pattern in which the model is formed [108]. However, in order to justify the effectiveness of the model, it is vital to use a mathematical verification method in order to complement the evaluation of the new UWB-MAC protocol. From equation (4.8), our modified version of the model continues.

To determine the energy consumed in the network with respect of using a directional system, it is easier to concentrate on the transmitting pattern because calculating the properties is stress-

free. In addition, the radiation pattern is unchangeable even when it is in receiving mode, which means the outcome of the analysis will be applicable to the receiving pattern too.

Assumption:

It is assumed we have two mobile nodes communicating with each other and each with a transmitting antenna with a wavelength of λ , a power of P_t and a Gain of G_t . Nonetheless, for the reception purpose, each receiving device has a gain of G_r with a receiving power threshold of $P_{r,\min}$ as in [5].

Using diffusion algorithm in [102], it can proving that the integration of directionality as a new entity will conserve more energy in the system.

If we consider using free space fading techniques as in [109], the distance covered by the antenna beam is going to be:

$$R_{\max} = \sqrt{\frac{\lambda^2 P_t G_t G_r}{(4\pi)^2 P_{r,\min}}} \quad (4.9)$$

Equation 0.9: Free Space Fading Equation

Where P_t and G_t constitute the major parameters for consideration in reserving energy. We substitute (4.7) for R_{\max} in our modified model.

Then,

$$\left(\frac{\alpha}{2fh} \right) = \sqrt{\frac{\lambda^2 P_t G_t G_r}{(4\pi)^2 P_{r,\min}}}$$

Therefore, our modified version will be:

$$P_{Total} = CR \left(\frac{\lambda^2 P_t G_t G_r}{(4\pi)^2 P_{r,\min}} \right)^\alpha T_{xA} \quad (4.10)$$

Equation 0.10: New Model for Analysis

Where P_{Total} is total power the system consumes.

Consequently, the angle of transmission T_{xA} with a power pattern $P_n(\theta)$ depends on the direction of the angle [106]. Therefore, the outcome of the transmission as T_{xA} less than 360^0 will give a perfect beam pattern. Analytically, it is assume that the appropriate antenna gain will be in uniform radiation, in order to obtain a sector shape.

Therefore, the transmission is tilted towards a specific direction and our new protocol requires a substantive appliance in order to store the angle at which the beam should be concentrated for successful connection between devices in the network.

From equation (4.10), T_{xA} can be expressed as the Power Gain of our transmitting antenna within an angle less than 360^0 . Thus, power gain $G(\theta, \varphi)$ per unit solid of a directional antenna transmitting within a specified direction, the said angle (θ, φ) in a direction can be defined as the power transmitted per unit angle.

From the fundamental theory of antennas [110] and first principles, directivity is a function of angle and beam width θ_P which can be expressed as:

$$\theta_p = \int_{2\pi} P(\theta) d\theta = \frac{2\pi}{G_t} \quad (4.11)$$

Equation 0.11: Angle of Transmission Equation

However, the general directivity equation [110] is given as

$$D = \frac{1}{\frac{1}{4\pi} \int_0^{2\pi} \int_0^{2\pi} |F(\theta, \phi)|^2 \sin \theta d\theta d\phi}$$

The above equation is complex compare to 4.11 especially the denominator. However, the clear definition of directivity can be quoted from[110] as below.

The directivity of an antenna can be defined as the ratio of the radiation intensity in a given direction from the antenna, to the radiation intensity average over all directions. The average radiation intensity is equal to the total power radiated by the antenna divided by 4π . If the direction is not specified, the direction of maximum radiation intensity is implied [111].

From Equation 4.11, $G_t \geq 1$, the constant value of G_t lies between θ_P of the antenna gain.

Assuming $G_t = 1$, $\theta_p = 2\pi$ then the transmission is in omni-directional mode.

$$\text{Our } T_{xA} = \theta_p = \frac{2\pi}{G_t}$$

Substituting (4.11) in (4.10) then we have:

$$P_{Total} = CR \left(\sqrt{\frac{\lambda^2 P_t G_t G_r}{(4\pi)^2 P_{r,\min}}} \right)^\alpha * \frac{2\pi}{G_t} \quad (4.12)$$

Equation 0.12: Energy Conservation Model

The area covered by the transmission is also proportional to the transmission power which can be expressed as:

$$A = \frac{\lambda^2 P_t G_r}{16\pi P_{r,\min}}$$

However, the area is not our main concern due to the fact that the issue has been solved by [110] and our concern is the directivity to save energy.

The Gain (G) of an antenna is also directly related to the Directivity (D) and the Antenna Efficiency (ϵ_R).

Mathematically,

$$G = \epsilon_R D \quad (4.13)$$

Equation 0.13: Antenna Gain relationship with Efficiency and Directivity

Therefore, from our early definition, Gain (G) of an antenna is directly proportional to the Height (H) of the antenna.

This implies that:

$$G \propto H$$

Equating G to H with a constant K in order to remove the proportionality then,

$$G = KH \quad (4.14)$$

Equation 0.14: How determine G with respect to H

Where K is the constant of proportionality and cannot have any impact on the transmission or reception in the communication scene. To prove that it has no impact, as G is the product of the constant K and the Height (H) then K is always assumed to be 1 as an identity number.

From the relation $G = \epsilon_R D$ we equate 13 and 14 to have:

$$\epsilon_R D = KH$$

$$\epsilon_R D - KH = 0$$

Therefore, our $G_t = \epsilon_R D - KH$.

Substituting G_t in (12) and our final model will be:

$$P_{Total} = CR \left(\sqrt{\frac{\lambda^2 P_t G_t G_r}{(4\pi)^2 P_{r,\min}}} \right)^\alpha * \frac{2\pi}{\epsilon_R D - KH} \quad (4.15)$$

Equation 0.15: Proposed Energy Conservation Model

The above model is tested for connectivity between mobile nodes of density 30 in MATLAB and at the average range of 2m between the nodes. Figure 4.8 shows the appearance of the nodes with an area of 200m x 200m for testing. The connection is successful for both Omni and Directional systems as in Figures 4.9 and 4.10.

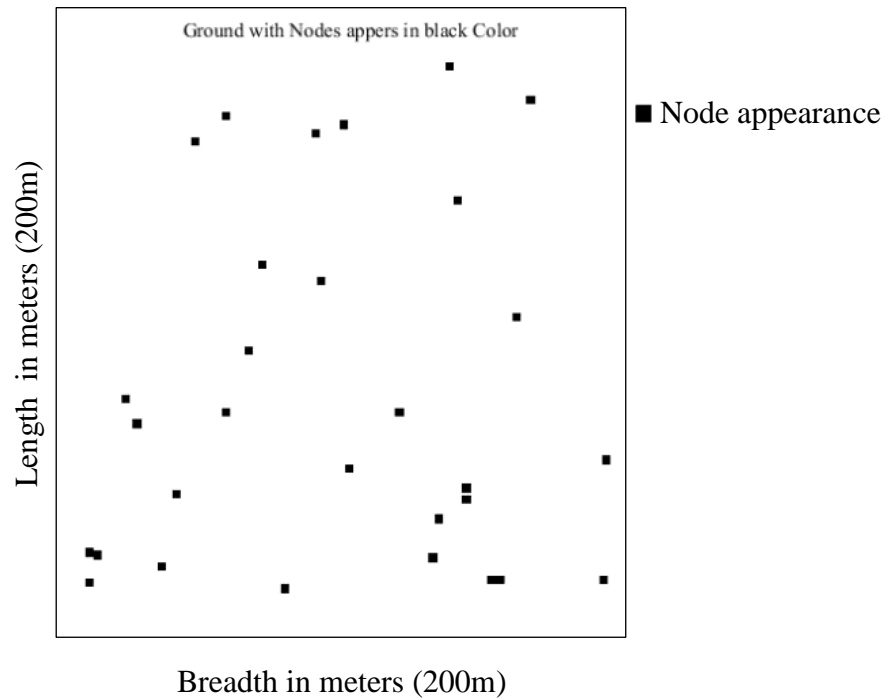

Figure 0.8: Network appearance of the setup

Figure 4.8 shows the creation of image view of mobile ad hoc network with 30 nodes with two different types of antenna system that is, using omni-directional and directional antenna. The program is created based on the proposed model and the output will request for number of nodes, network size (width and length in meters), antenna height, efficiency of the antenna, directivity of the antenna and gain of the antenna.

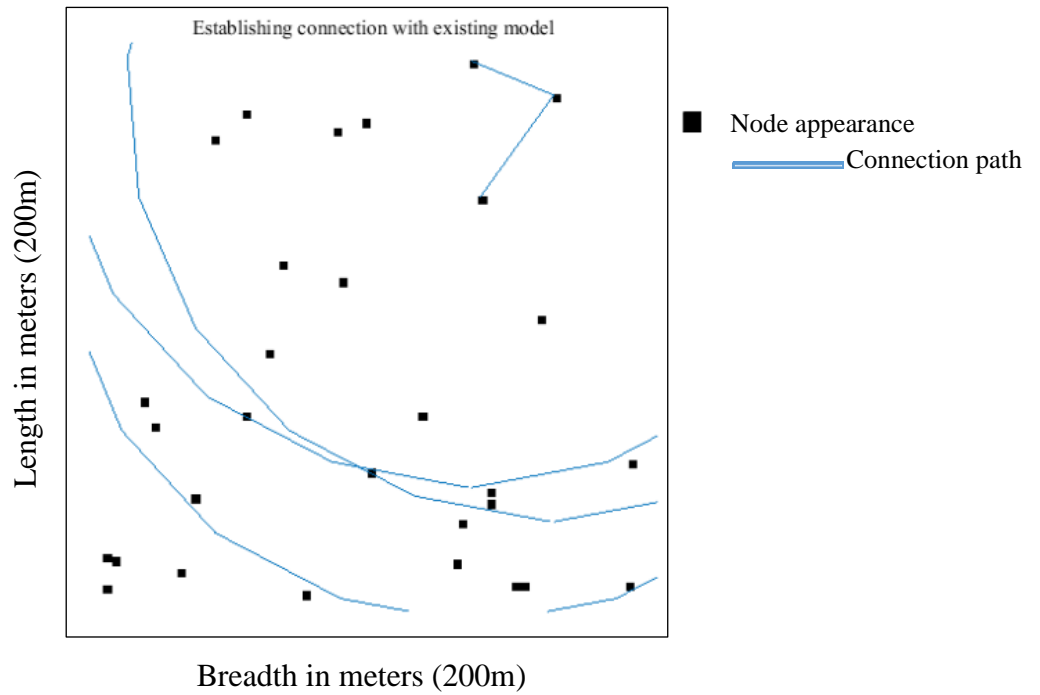

Figure 0.9: New model communicational with Omni System

Figure 4.9 displayed nodes in active communication using Omni-directional antenna with the proposed model. The blue line shows the path of connection between the nodes while the black rectangular dots represent the nodes.

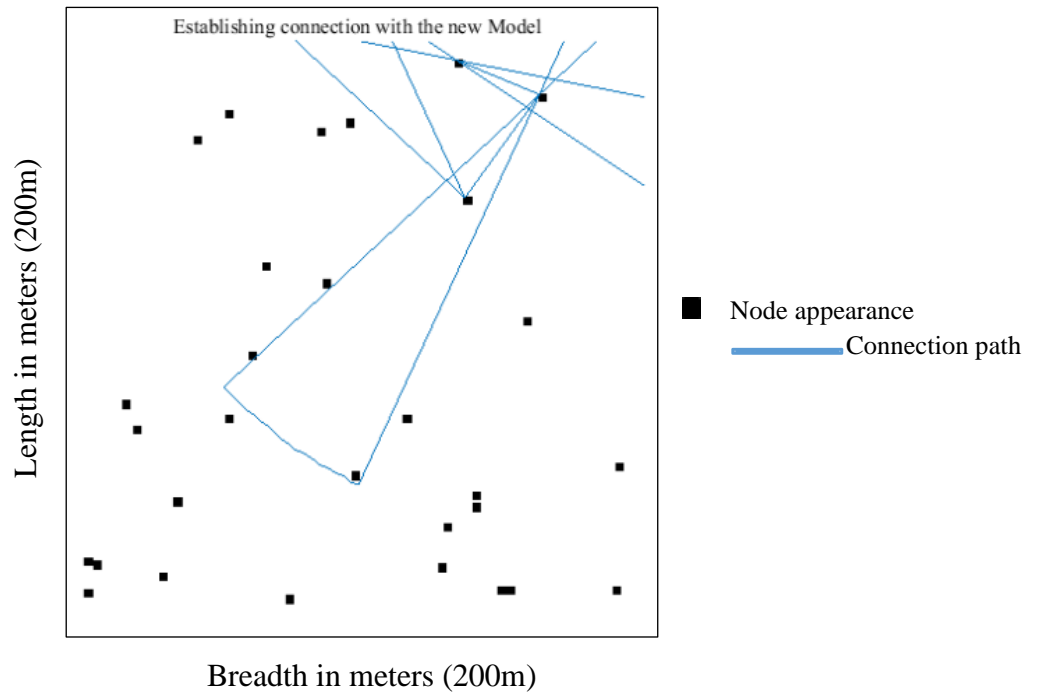

Figure 0.10: New model communicational with Directional System

Figure 4.9 displayed nodes in communication using directional antenna with the proposed model. The three nodes from the topmost right corner are the active nodes and the blue lines are communication traces between the nodes which define angle of transmission. The black rectangular dots are the nodes in the communication medium.

Part of the modified MAC needs to be omni when it is transmitting the RTS/CTS frame. It will be sending out duration fields and enhancing transmission using directional antennas based on steerable antenna properties. The additional directivity strategy will provide additional gain to the antenna and it will obviously save enormous power in the system. This implies that by using directional radio, the devices in the network can reduce the power consumption level and will remain with the same SNR for transmitter and receiver. Also because of directivity of the transmission/reception, the system will define a spectrum that has less interference and this could save power in transmission and attain the same signal-noise ration. The speed of the system is also increase because of the directional antenna, this leads to devices in the network to have less time in active mode and this could also save energy.

When we transmit CTS/RTS frames across the transmission path using the omni system, as the connection is established, then it will switch to the directional system, provided the same gain has been utilised. Obviously, the power is going to be reducing by a significant factor. Our proposed model is going to reduce the power but the same gain is going to be utilised with the same signal strength because of the directivity of the antenna. The switching system as in [100] has been used for transmitting and reception. The system will switch between omni-directional and directional in the context of RTS/CTS exchange respectively. As RTS serves as the initial process of transmission, the use of the omni system will be established in order to support location finding. After RTS receives then, for CTS to take place, then the use of directional system. That is the initial stage of minimising energy consumption in the system.

Meanwhile, testing the final model using some justified parameters (refer to appendices section) in equation 4.15 to prove the validity of the model. The validation will be concentrated on directivity parameters and other constraints. Other parameters like node-degree constraint, location information and the basic theoretical power techniques will be tested using either graph theory or any available techniques.

4.5 Numerical Evaluation of the Proposed Model

Considering changes in Constant BitRate (CBR), Number of Request, Antenna High and Distance in order to evaluate the performance of the proposed system. In the first instance, it is assume that the CRB is constant and iterate the values of distance, number of requests and propagation to test the validity of the system. The tables for the iteration are in the appendix section for clarification. Table 4.3 presents both the existing and proposed models.

Table 4.3a: Existing and proposed model

Existing Model	Proposed Model
$P_{Total} = CR \left(\sqrt{\frac{\lambda^2 P_t G_t G_r}{(4\pi)^2 P_{r,\min}}} \right)^\alpha T_{XA}$	$P_{Total} = CR \left(\sqrt{\frac{\lambda^2 P_t G_t G_r}{(4\pi)^2 P_{r,\min}}} \right)^\alpha * \frac{2\pi}{\epsilon_R D - KH}$

Proof:

i. Change in Power with Respect to Number of Request (R)

It is assumed there are 10 to 60 nodes in the network with a cluster of tens in an interval and other parameters as in Table 4.4 for testing both the existing and proposed models.

Table 0.2b: Numerical values used for validating the System

Parameter	Values
Constant Bitrate (C)	1000bit/s
Number of Request (R)	10,20,30,40,50and 60
Distance (d)	2m
Propagation Channel (α)	2-4
Omni directional transmission (T_{XA})	360^0
Efficiency of the transmission/reception (ϵ_R)	0.5
Directivity (D)	22^0
Constant of Proportionality (K)	1
Antenna Height (H)	9.6

The two equations in table 4.3a for the existing and proposed model were iterated to find change in energy with respect to change in network density. Constant bit rate, propagation channel, distance between nodes and other parameters were assumed to be constant in order to determine the total energy consumed in the system for both existing and proposed solution. Density is the number of request (R) and iterated from 10,20,30,40,50 to 60. Appendix A(vi) is the table for the iteration and the interested columns that produces figure 4.11 are total power

columns for existing and proposed model. The mathematical expression of equation 4.16 and 4.17 represent the change with respect to density.

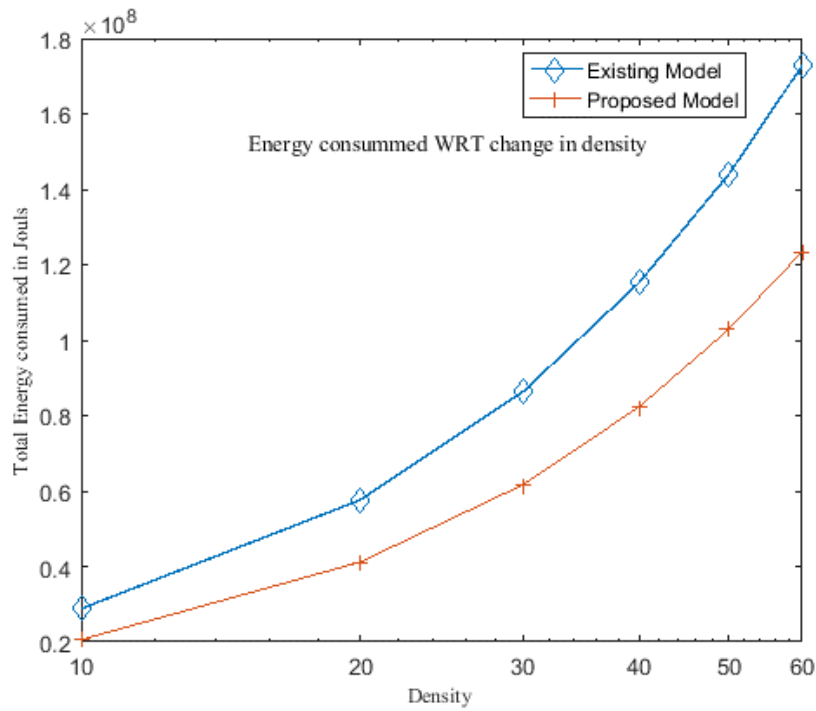

Figure 0.11: Energy consumed WRT Change in Number of Request (R)

Mathematically,

From table 4.3 row 2, column 2 we have

$$P'(R) = \frac{\partial p}{\partial R} = d^\alpha \cdot \frac{2\pi}{\varepsilon_R D - KH} \cdot C + (CR.0) \quad (4.16)$$

$$P'(R) = \frac{\partial p}{\partial R} = Cd^\alpha \cdot \frac{2\pi}{\varepsilon_R D - KH} \quad (4.17)$$

Equation 0.16: Change in Density (R)

ii. Change in Power with Respect to Distance (d)

Subsequently, the two equations in table 4.3a for the existing and proposed model were iterated to find change in energy with respect to change distance between the nodes. Constant bit rate, propagation channel, number of request and other parameters were assumed to be constant in order to determine the total energy consumed in the system for both existing and proposed solution. Appendix A(v) is the table for the iteration and the interested columns that produces figure 4.12 are Ptotal columns for existing and proposed model. The mathematical expression of equation 4.18 and 4.19 represent the change with respect to distance. As distance is varied between the nodes from 1m, 2m, 3m, 4m, 5m and 6m and assume the propagation channel to be 2 in order to validate the potentiality of the model with respect to energy consumption. The proposed model works better than the existing system as shown in Figure 4.12.

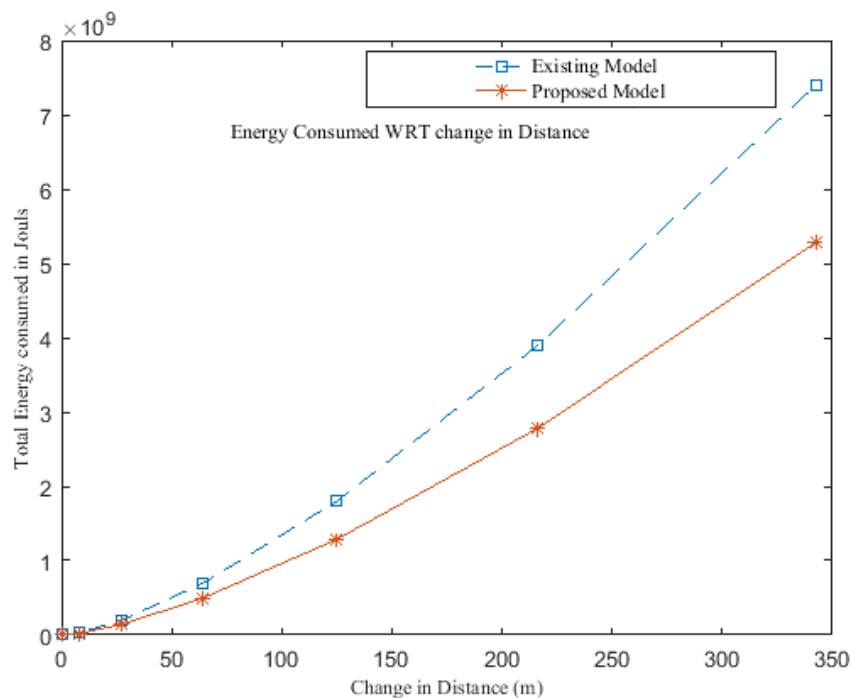

Figure 0.12: Energy consumed WRT Change in distance (d)

Also from table 4.3 row 2, column 2 we have;

$$P^l(d) = \frac{\partial p}{\partial d} = \frac{2\pi}{\varepsilon_R D - KH} \cdot \alpha CRd^{\alpha-1} \quad (4.18)$$

$$P^l(d) = \alpha CRd^{\alpha-1} \cdot \frac{2\pi}{\varepsilon_R D - KH} \quad (4.19)$$

Equation 0.17: Change in Distance (d)

iii. Change in Power With Respect to Propagation Channel (α)

Testing the two equations again by iterating changes with respect to propagation channel and leaving other parameters to be constant has been done which produces figure 4.13; and this determined the total energy consumed in the system for both existing and proposed solution. Appendix A(iii) is the table for the iteration and the interested columns that produces figure 4.13 are Ptotal columns for existing and proposed model. The mathematical expression of equation 4.20 and 4.21 represent the change with respect to distance.

Figure 4.13 obeys the values in Table 4.3 with values of α to be 2, 2.5, 3.0, 3.5 and 4.0. The energy consumed in the system, with respect to change in propagation, depends on distance between the nodes and it is assume that the distance is constant ($d = 2m$). The system still records a positive difference compared to the existing system as in Figure 4.13.

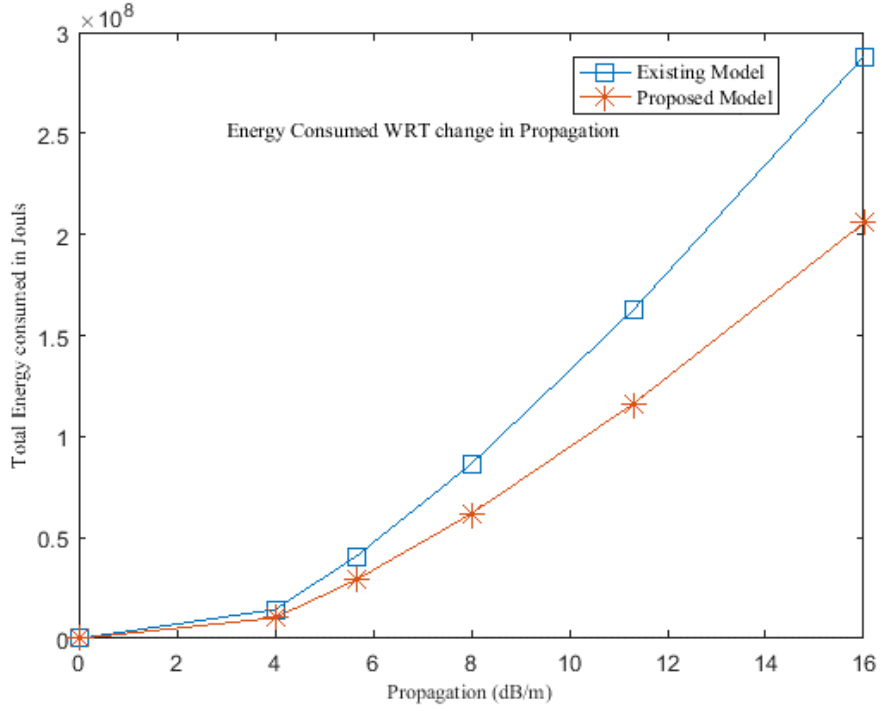

Figure 0.13: Energy consumed WRT Change in Propagation (α)

$$P^l(\alpha) = \frac{\partial p}{\partial \alpha} = \frac{(\varepsilon_R D - KH)(2\pi CRd^\alpha) - (2\pi CRd^\alpha * 0)}{(\varepsilon_R D - KH)^2} \quad (4.20)$$

$$P^l(\alpha) = \frac{(\varepsilon_R D - KH)(2\pi CRd^\alpha)}{(\varepsilon_R D - KH)^2} \quad (4.21)$$

$$P^l(\alpha) = \frac{2\pi CRd^\alpha \varepsilon_R D - 2\pi CRd^\alpha KH}{(\varepsilon_R D - KH)^2}$$

Equation 0.18: Change in Propagation (α)

Figure 4.14 shows the iteration propagations (2, 2.5, 3.0, 3.5 and 4.0) against number request (R) to show that, irrespective of the change in propagation, the system is still stable and the proposed system outsmarts the existing in terms of energy conservation.

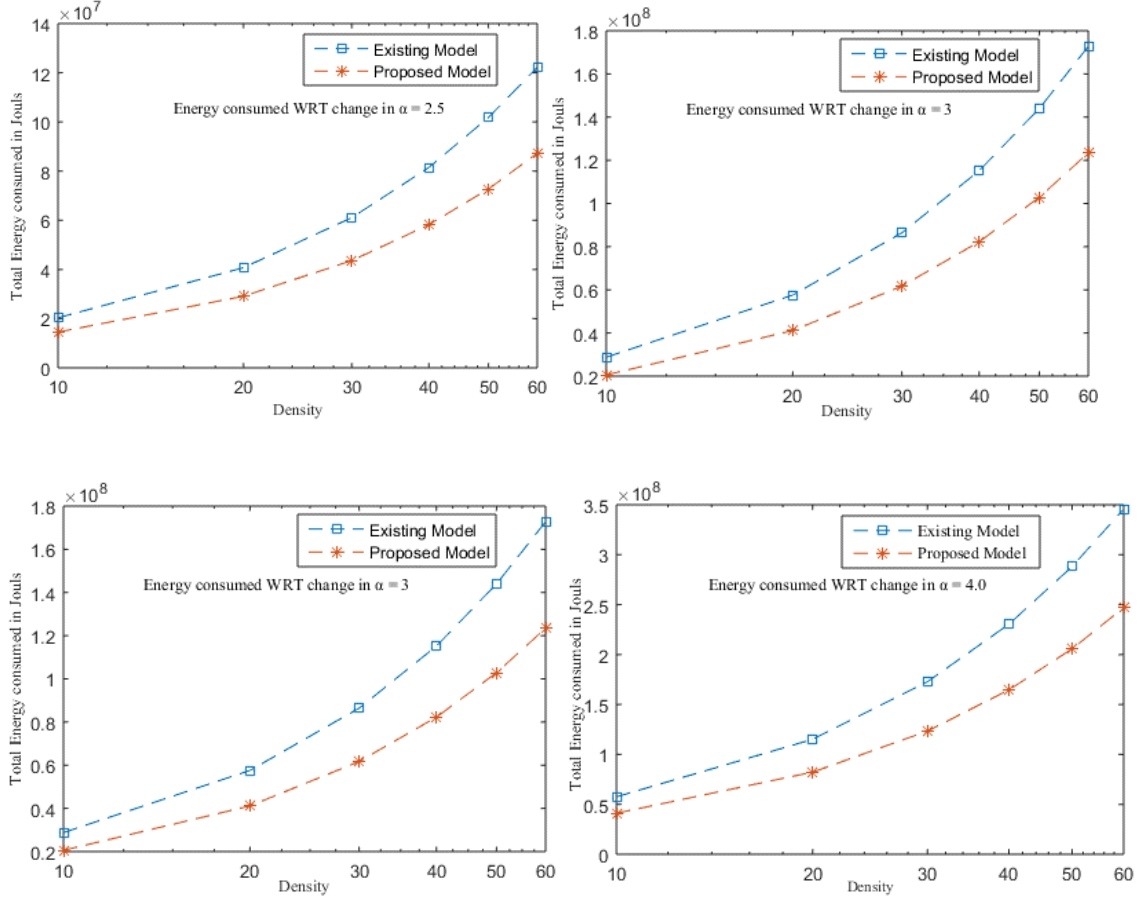

Figure 0.14: Energy consumed WRT Change in α against Network Density

Subsequently, the next derivative of α will result in substantiating that the modified model will save more energy than the existing model with clear efficiency.

And P^{\parallel} or $\frac{\partial^2 P}{\partial \alpha^2}$ will be:

$$P^{\parallel}(\alpha) = \frac{(\varepsilon_R D - KH)^2 (2\pi \varepsilon_R D C R d^\alpha) - (2\pi K H C R d^\alpha)}{(\varepsilon_R D - KH)^4} \quad (4.24)$$

Equating it to zero we have;

$$(\varepsilon_R D - KH)^2 (2\pi \varepsilon_R D C R d^\alpha) - (2\pi K H C R d^\alpha) = 0 \quad (4.25)$$

$$(\varepsilon_R D - KH)^2 (2\pi \varepsilon_R D C R d^\alpha) = 2\pi K H C R d^\alpha \quad (4.26)$$

$\epsilon_R D = KH$ After cancelation, this shows that the modified version works perfect.

iv. Change in Power With Respect to Antenna High (H)

The height of the antenna also tallies with the expected outcome as shown in Figure 4.15. The values of H were varied with 4.8, 5.8, 6.8, 7.8, 8.8 and 9.6ft to test the performance of the proposed system against the existing system and the result in Figure 4.15 shows that the proposed system conserved more energy than the existing system. Appendix A(i) is the table for the iteration and the interested columns that produces figure 4.15 are Ptotal columns for existing and proposed model

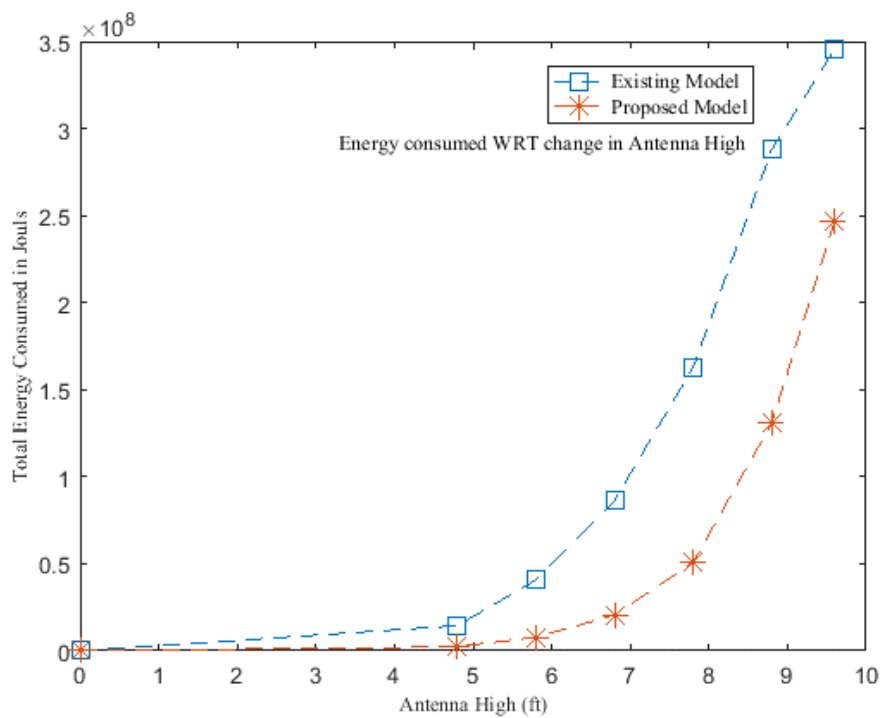

Figure 0.15: Energy consumed WRT Change in Antenna Height (H)

Also from table 4.3 row 2, column 2 we have;

$$P'(H) = \frac{\partial p}{\partial H} = \frac{(\epsilon_R D - KH).0 - (2\pi CRd^\alpha).-K}{(\epsilon_R D - KH)^2} \quad (4.27)$$

$$P^l(H) = \frac{2\pi KCRd^\alpha}{(\epsilon_R D - KH)^2} \quad (4.28)$$

Equation 4.28: Change in Antenna Height (H)

Figure 4.14 shows the iteration of Antenna Height (4.8, 5.8, 6.8 and 7.8ft) against Number Request (R) to show that, irrespective of the change in Antenna Height (H), the system is still stable and the proposed system outsmarts the existing in terms of energy conservation.

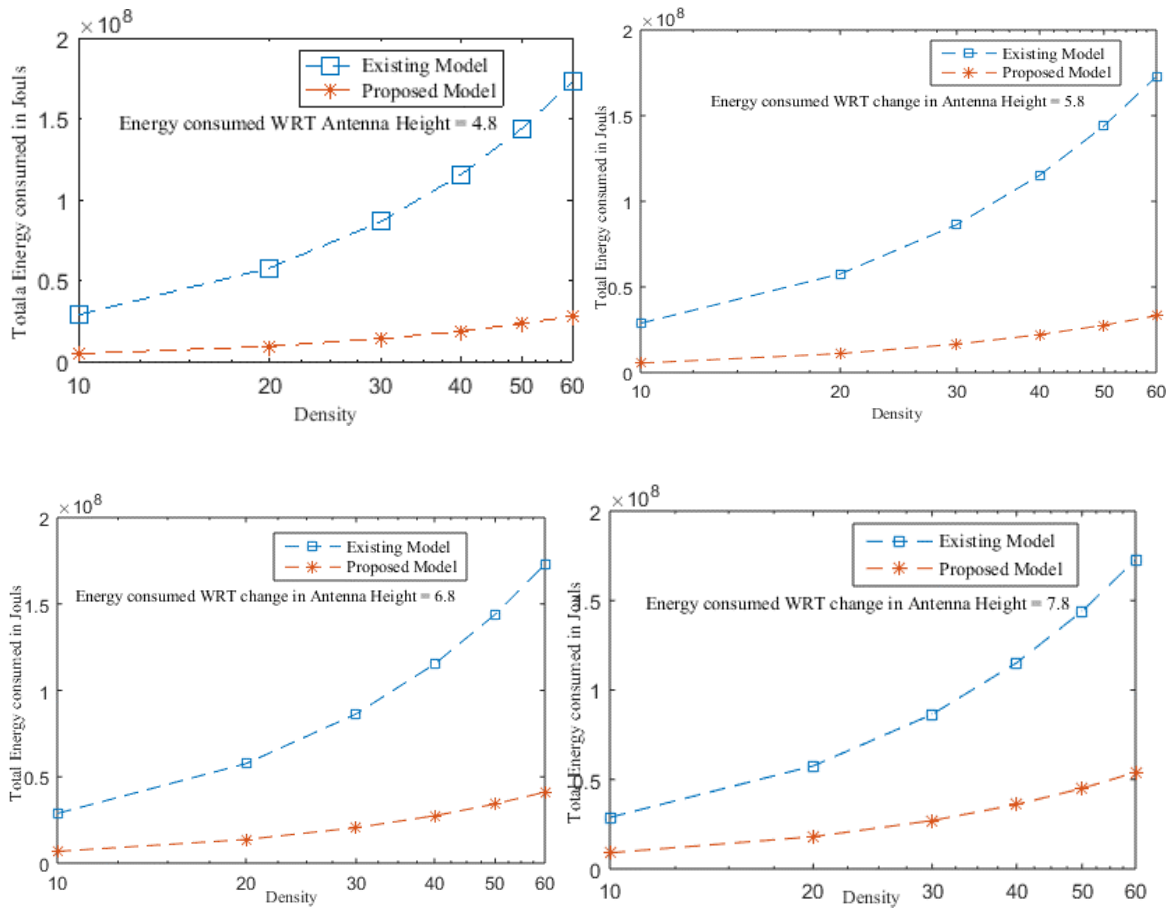

Figure 0.16: Energy consumed WRT change in H against network density

Further iteration with respect to H will prove the validity of the system and the proper definition of Antenna Height will be clear in terms of efficiency and distance.

$$P^{\parallel}(H) = \frac{(\varepsilon_R D - KH)^2 \cdot 0 - 2\pi KCRd^\alpha * 2(\varepsilon_R D - KH) * -K}{(\varepsilon_R D - KH)^4} \quad (4.29)$$

$$P^{\parallel}(H) = \frac{-2\pi KCRd^\alpha * 2K(\varepsilon_R D - KH)}{(\varepsilon_R D - KH)^4} \quad (4.30)$$

$$\frac{4K^2\pi CRd^\alpha (\varepsilon_R D - KH)}{(\varepsilon_R D - KH)^4} = 0 \quad (4.31)$$

$$4K^2\pi CRd^\alpha (\varepsilon_R D - KH) = 0 \quad (4.32)$$

$$4K^2\pi CRd^\alpha \varepsilon_R D - 4K^3\pi CRd^\alpha H = 0 \quad (4.33)$$

$$H = \frac{4K^2\pi CRd^\alpha \varepsilon_R D}{4K^3\pi CRd^\alpha} \quad (4.34)$$

$$H = \frac{\varepsilon_R D}{K} \quad (4.35)$$

Which is the same thing with the initial definition of an Antenna High.

v. Change in Power With Respect to Directivity (D)

The system adopts 22° for directivity from literature and the change in angles of transmission do affect power consumption in the system. Other angles (32° , 42° , 52° , 62° and 72°) were tested to validate the system. Figure 4.17 presents the total energy consumed by both existing and proposed models against Directivity (D) and results showed that the proposed system performs better.

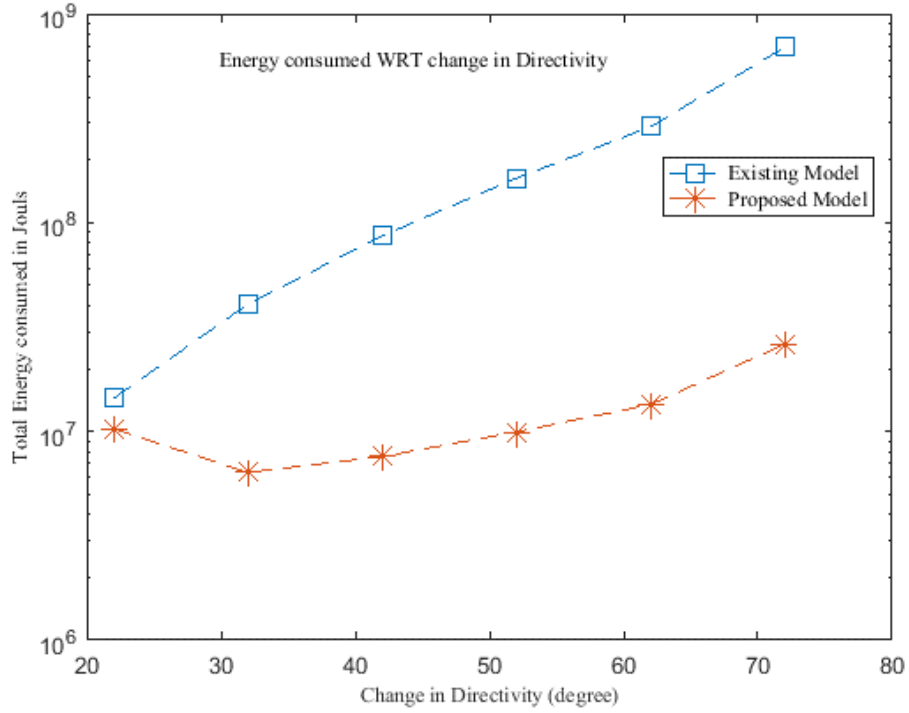

Figure 0.17: Energy consumed WRT Change in Directivity (D)

The proof is as follows.

$$P'(D) = \frac{\partial p}{\partial D} = \frac{(\varepsilon_R D - KH) \cdot 0 - 2\pi CRd^\alpha \cdot \varepsilon_R}{(\varepsilon_R D - KH)^2} \quad (4.36)$$

$$P'(D) = \frac{-2\pi CRd^\alpha \varepsilon_R}{(\varepsilon_R D - KH)^2} \quad (4.37)$$

Equation 4.37: Change in Directivity (D)

Figure 4.18 presents different iterations of Directivity (D) and implies that the proposed system saves more energy than the existing model.

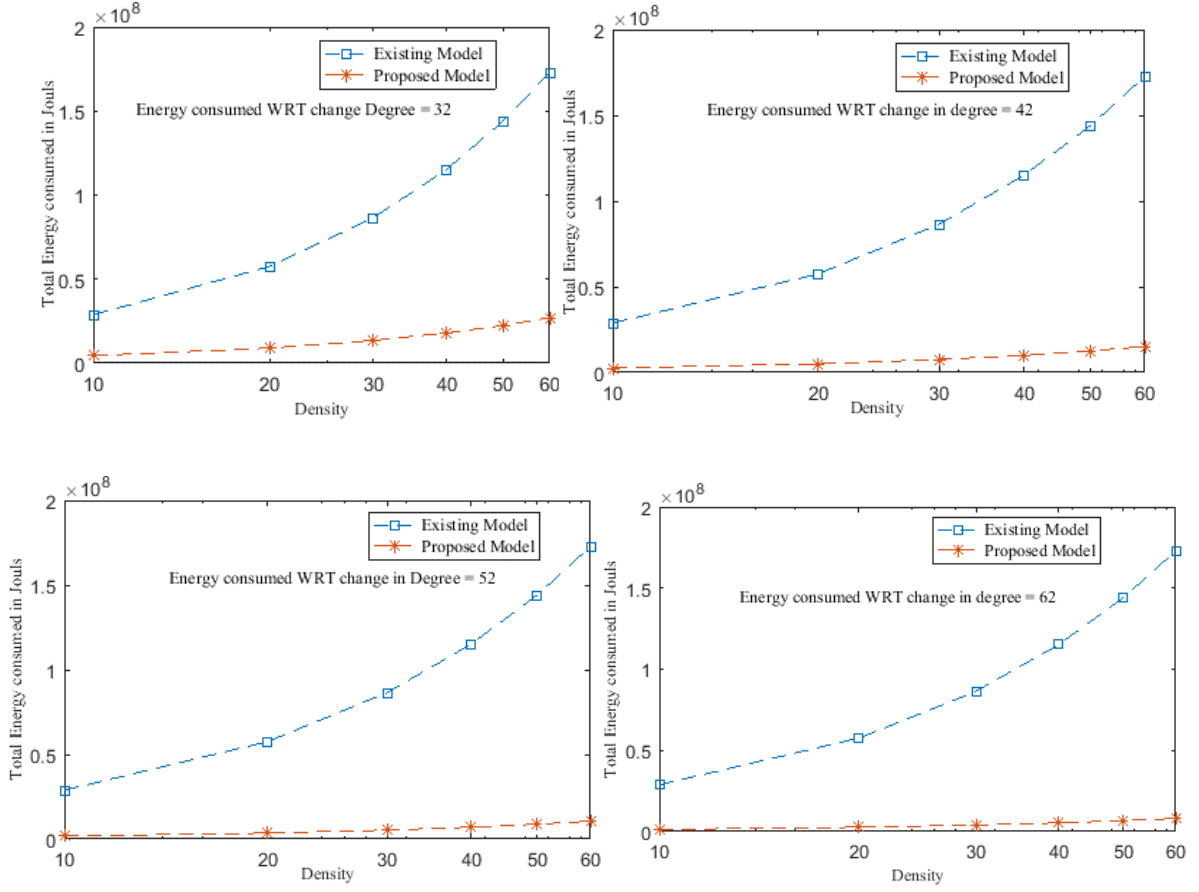

Figure 0.18: Energy consumed WRT change in D against network density

Finding the second derivative of the above equation will prove that the directivity of the system is the quotient of the antenna height and efficiency of the system. To show this,

$$P^{\parallel}(D) = \frac{(\varepsilon_R D - KH)^2 \cdot 0 - (-2\pi C R \varepsilon_R D d^\alpha) * 2(\varepsilon_R D - KH) * \varepsilon_R}{(\varepsilon_R D - KH)^4}$$

$$P^{\parallel}(D) = \frac{2\pi C R \varepsilon_R d^\alpha * 2(\varepsilon_R D - KH) * \varepsilon_R}{(\varepsilon_R D - KH)^4} \quad (4.39)$$

Equating it to zero where $P^{\parallel}(D) = 0$ then we have

$$\frac{4\pi C R \varepsilon_R d^\alpha (\varepsilon_R D - KH)}{(\varepsilon_R D - KH)^4} = 0 \quad (4.40)$$

$$4\pi C R \varepsilon_R^2 d^\alpha (\varepsilon_R D - KH) = 0 \quad (4.41)$$

$$4\pi CRd^\alpha \varepsilon_R^3 D - 4\pi CR\varepsilon_R^2 d^\alpha KH = 0 \quad (4.42)$$

$$4\pi CRd^\alpha \varepsilon_R^3 D = 4\pi CR\varepsilon_R^2 d^\alpha KH \quad (4.43)$$

$$\frac{4\pi CRd^\alpha \varepsilon_R^3 D}{4\pi CRd^\alpha \varepsilon_R^3} = \frac{4\pi CR\varepsilon_R^2 d^\alpha KH}{4\pi CRd^\alpha \varepsilon_R^3} \quad (4.44)$$

$$D = \frac{KH}{\varepsilon_R} \text{ but } K=1 \text{ therefore } D = \frac{H}{\varepsilon_R}$$

vi. Change in Power With Respect to Constant Bitrate (c)

Change in Constant Bitrate shows that the sequence produces a series in which the consecutive term differs by the same amount and this shows that the system is a common second difference. Therefore, the resulting differences of other parameters in the system can also affect the performance of the system. Constant bit rate (C) is tested C against density, C against distance and C against propagation channel respectively to study the effect of each parameter in the system. It was found that the proposed system performs better in terms of power saving than the existing model. Figure 4.20 (a-d) presents the graphical representation of the changes with respect to distance, density and propagation.

Figure 4.19 presents the change in constant bitrate at (200, 400, 800, 1200, 1600 and 2000bit/s). The proposed model consumes less energy than the existing model.

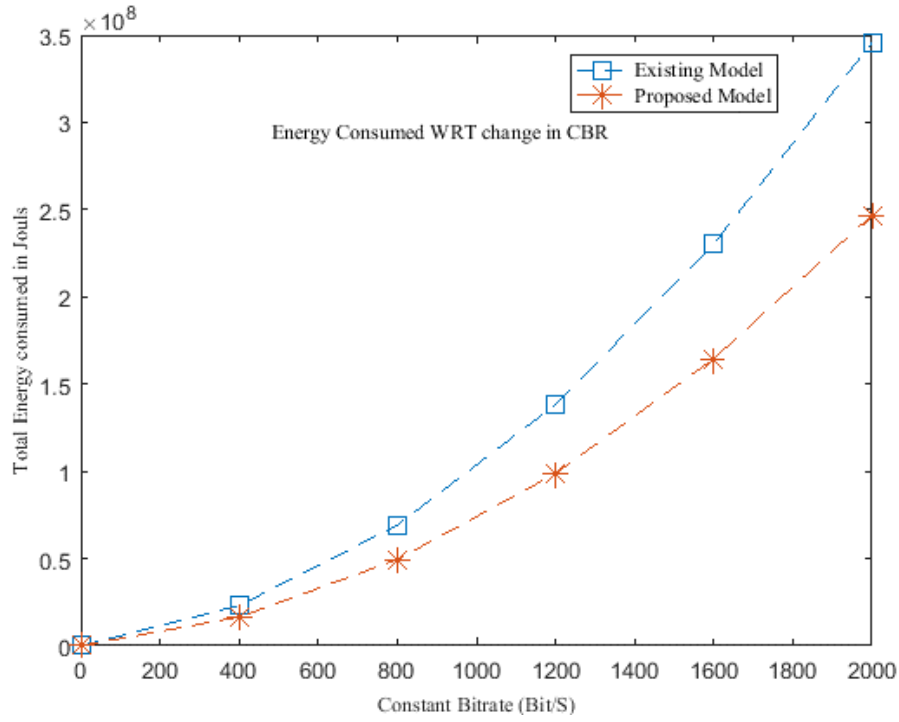

Figure 0.19: Energy consumed WRT Change in Constant Bitrate (C)

Additionally, from Table 4.3, row 2, column 2, changes in power with respect to C can be described mathematically as:

$$P'(C) = \frac{\partial p}{\partial C} = d^\alpha \cdot \frac{2\pi}{\varepsilon_R D - KH} \cdot R + (CR.0) \quad (4.45)$$

$$P'(C) = Rd^\alpha \cdot \frac{2\pi}{\varepsilon_R D - KH} \cdot \quad (4.46)$$

Equation 4.37: Change in Constant Bitrate (C)

The summation of the total energy consumed by the existing and proposed system of constant bitrate with respect to change in density, distance and propagation is presented in Figure 4.20 (a-d).

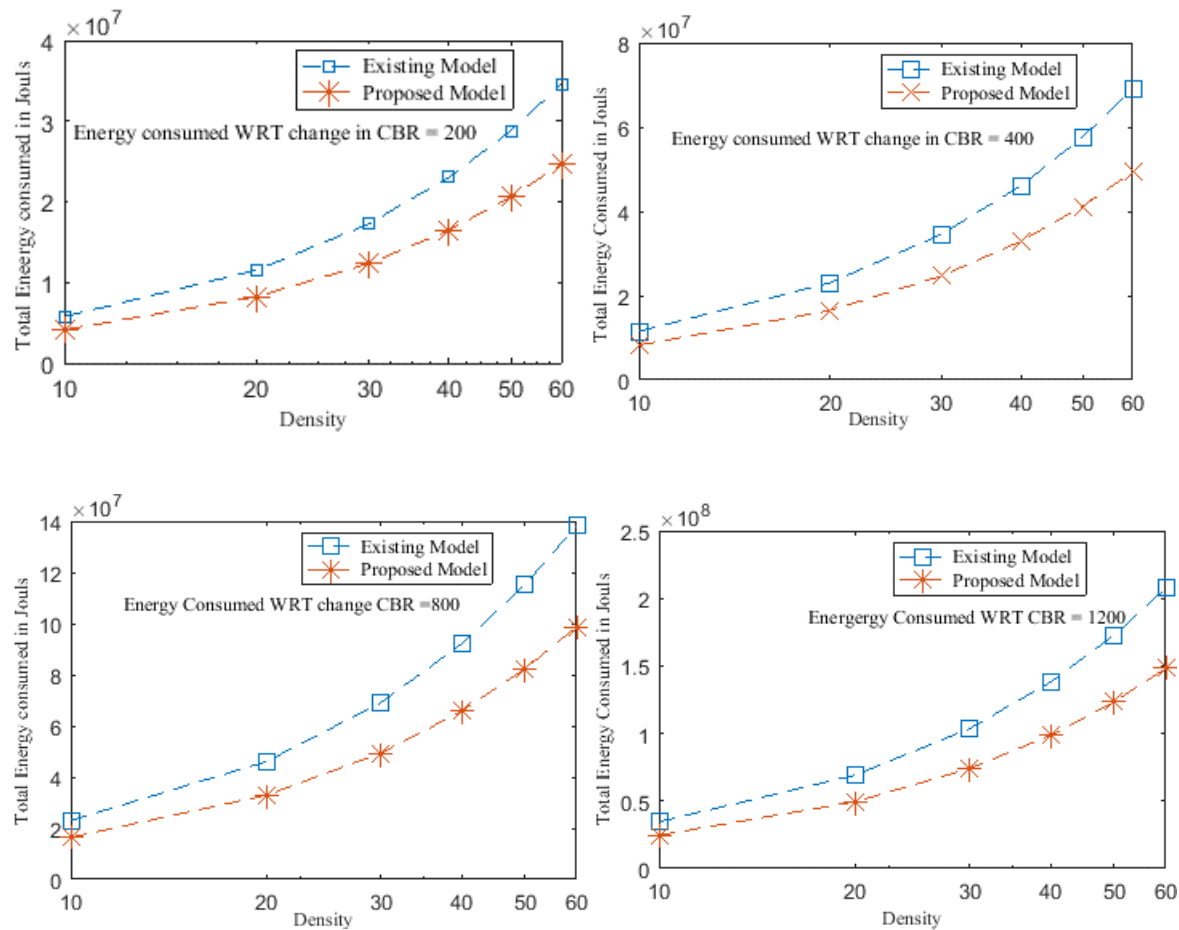

Figure 0.20: Energy consumed WRT change in C against network density

4.6 Discussion

MANET has limited capacity due to its unique nature which constitutes the attributes of an unsupported administrative device to aid communication as in a conventional network. Considering that, it is highly recommended to determine the size of the network with respect to dimension, number of nodes participating and the geographical location. The basic is the total number of nodes deployed in the network to determine the performance of the traffic deployed. As the density of the network constitutes one of the basic parameters for

consideration, coming up with a clear and simple design process in order to analyse the traffic generated from the model is vital. The traffic analysis will track two different patterns because of the used of simalytic approach. The analytical aspect determines the connectivity of the mobile nodes and the way in which the proposed MAC will communicate with other layers of the network. The simulation part will concentrate on generating traffic like numbers of packet drops due to collision in the channel, the energy consumed at the MAC layer, total battery charged, percentage of time in transmission and finally, the goodput of the network.

4.7 Chapter Summary

The chapter presents a design concept of the proposed system and the schematic variables used in the design. Presentation of the model constraints and the way in which the proposed model was modified for traffic presentation and analysis. Model formulation and validation are also presented in order to support the existence of the system. Finally, presentation of a numerical evaluation of the proposed system in order to test its perfection by using some numerical data from literature, as presented in the appendix section. The results obtained show that the proposed model performs better in saving energy in MANET. Results in Section 4.6 indicate that there is a positive and remarkable difference between the proposed and the existing models. The next chapter, which is the framework, algorithm and implementation, will present the detailed explanation of how the proposed protocol is achieved.

Chapter Five

5.0 Framework, Implementation and Algorithm

5.1 Introduction

This chapter highlights the implementation of the design concept with a detailed explanation of the concept formulation. First, a framework is presented which analytically describes the variations and context of the proposed protocol. The proposed framework also presents the conceptual distinctions and how the idea is organised based on the computer networks' standard. The proposed model has been implemented in a simulated environment, based on the MATLAB software package, which mimics the real-life application of the system. The MAC layer setting was carried out and conformed to the European Computer Manufacturers' Association (ECMA) 368 standard for appropriate representation of the proposed model. The chapter has been divided into sections. The PHY stack of the proposed protocol was considered, comprising sub-sections that focused on transmitter, channel, UWB system and receiver. The coding and modulation for the expected signal sections are also included. The Multi-Band Orthogonal Frequency Modulation (MB-OFDM) implementation of the proposed UWB-MAC on a MIMO system is considered which supports the channel model to deduce the indoor distortion that came as a result of a wireless signal in a close environment. The implementation of the receiving section is also based on the 368 standard and how this links with the channel and back to the transmitting section. The study also presents the Asynchronous Power Saving and state-based energy model for the implementation of the proposed model. The algorithm and state-based model for power saving is presented and concluding remarks summarise the outcome of the implementation procedures.

5.2 Framework of the Proposed Protocol

The proposed framework of the protocol is based on the OSI model architecture from the application layer to the physical layer. The application layer is assumed to refer to multimedia transmission over a multi-hop network and is characterised by sensing activities, channel coding improvement and time varying channel conditions as presented in Figure 5.1. The transport stack of the proposed protocol is UDP. The test of heavy multimedia applications like VoIP is assumed for testing the viability of the protocol. The network layer signified the use of multi-hop connections with multiple devices to express the nature of MANETs and MB-OFDM support. This also signifies that there exists a communication link between all the devices in the network, all of which are mutually independent. That means each node is capable of laying packets for other nodes in the network with a traverse of multiple nodes in order to access a destination device.

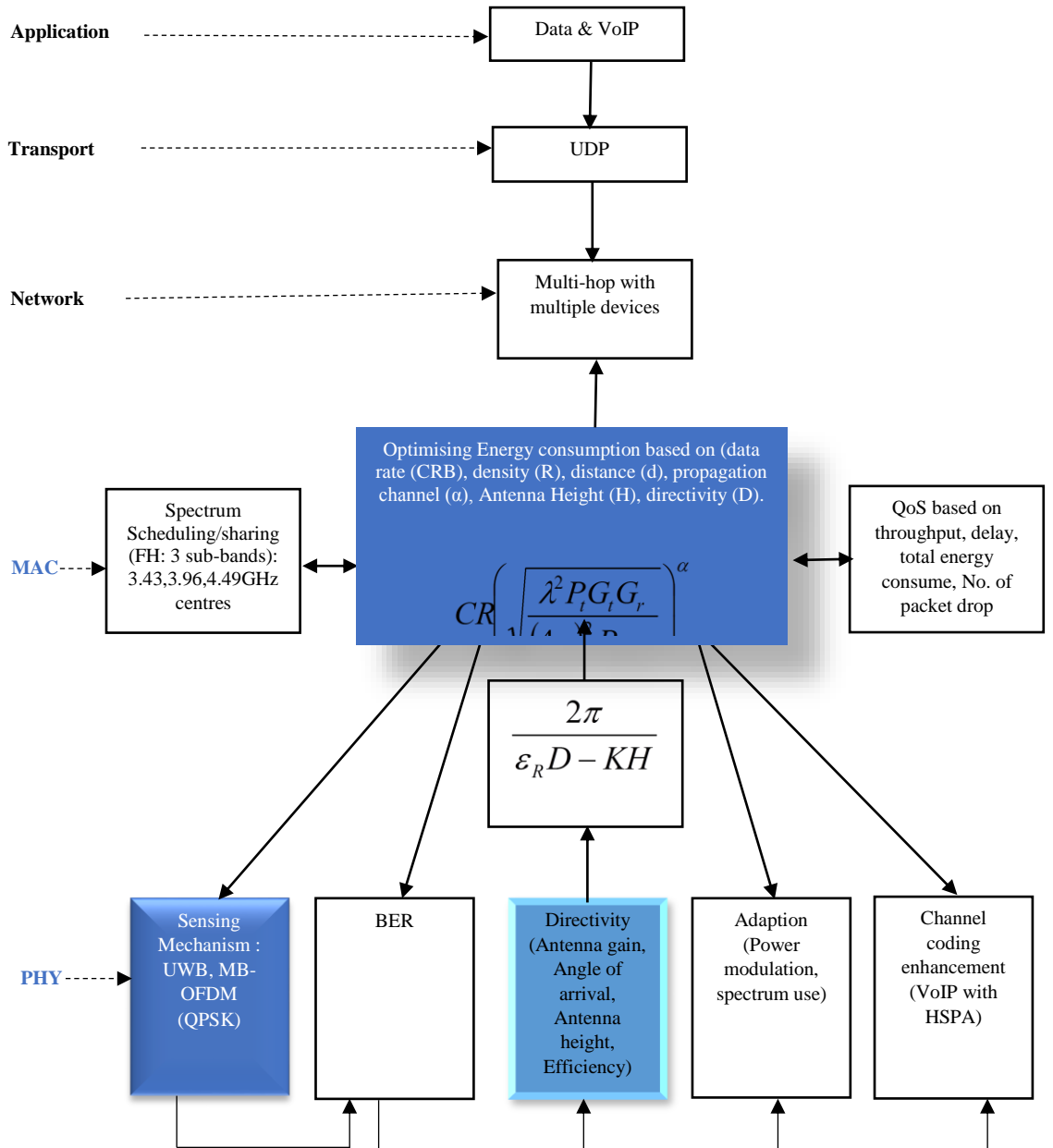

Figure 0.1: Framework of the Proposed UWB-MAC with Steerable Direction Antenna

The implementation of the MAC layer, based on the conceptual framework indicated in Figure 5.1, is considered by defining three basic mediums: the spectrum scheduling/sharing, energy optimisation entities and the quality of service of the proposed UWB-MAC. The spectrum scheduling/sharing technique is Frequency-Hopping (FH) with 3 sub-bands of 3.43, 3.96 and 4.49GHz centres. Testing these three sub-bands for performance precision is beyond the

research study because other literature has covered such a gap. The suitable task done by the FH is to help select the best code for executing sub-channels within the channel and to perform encoding/decoding frames of data. Transmission and reception are synchronised to the hopping sequence and assumed to involve fast hopping which changes the frequency several times in order to transmit a single bit.

The second entity of the proposed UWB-MAC, which is energy optimisation, can be iterated after the spectrum scheduling of the frequency-hopping. These are data rate, density of the network, distances between the nodes, propagation channel, Antenna Height and directivity. The behaviour of the proposed system relies on these entities and this will determine the output of the system. The quality of the proposed protocol based on network quality of service (QoS) parameters such as throughput, delay, total energy consumed at the MAC layer and total numbers of packet drop in the communication medium have been measured. The output varies with the changes in respect to entities of the antenna used and the direction of transmission.

Generally, the PHY stack is responsible for frequency generation, frequency selection, modulation, signal detection and data encryption. However, this study focused mainly on the sensing strength of the MIMO channel to determine how MB-OFDM performs and the capacity of QPSK performance with respect to changes in the measured entities at the MAC layer. This determines the digital modulation used, Analog-to-Digital Converter (ADC/DAC) resolution, and the internal resolution of the First Fourier Transformation (FFT) algorithm. These are the factors on which the power management depends at the PHY stack of the protocol. In addition, it also determines the data rate of the system, transmitting power, receiving power and deep sleep power of the devices participating in the system although, the performance of the sensing aspect of the PHY stack is beyond the content of this research study. Other sections of the PHY stack are Bit Error Rate (BER), directivity, adaption and channel coding enhance. BER determines the existence of the MIMO system for multi-system transmission and it also serves

as a link between the antenna directivity. At the PHY layer, the research focused on the directivity entity as the measure concerned with determining the output of the system. Directivity depends on the antenna gain, angle of arrival, antenna height and the efficiency of the antenna. These will determine the power consumed at the PHY stack with respect to modulation and spectrum usage.

Aside from ordinary data packets, VoIP is used as the targeted multimedia application to test the viability of the proposed UWB-MAC. VoIP is typically a very heavy application and requires the enhancement of channel coding to obtain an optimised version of the protocol. They have used High Speed Packet Access (HSPA) in order to improve download and upload speeds of the voice communication within the PHY stack. The impact of HSPA transmission over the UWB communication channel will stabilise the protocol because of the Band3 usage, thus allowing an additional noise to the channel by the repeater at the UWB working frequencies. Sections 5.3, 5.5 and 5.6 describe the PHY stack of the system. Section 5.4 describes the channel utilisation process, while sections 5.7 to 5.10 present power saving algorithms and state-based energy saving models of the proposed system.

5.3 Transmission Implementation

In the implementation of the transmitter section, this study considered the Wireless Sensor Network standard module which is also based on the PHY properties of the 368 standard. In this case, a complete communication system is modelled, based on the proposed model using a MATLAB Simulink that include elements of transmitter and receiver components array. The transmission section includes an initiating transmitter, transmitting spectrum and input/output transmitter array as presented in Figure 5.1. Additionally, the system was modelled using Simulink in order to integrate the proposed model to mimic a real PHY layer of the system.

The transmitting section generates the input signal through the channel model that alternates the signal noise and passes it to the receiving array and to the beamformer for directivity.

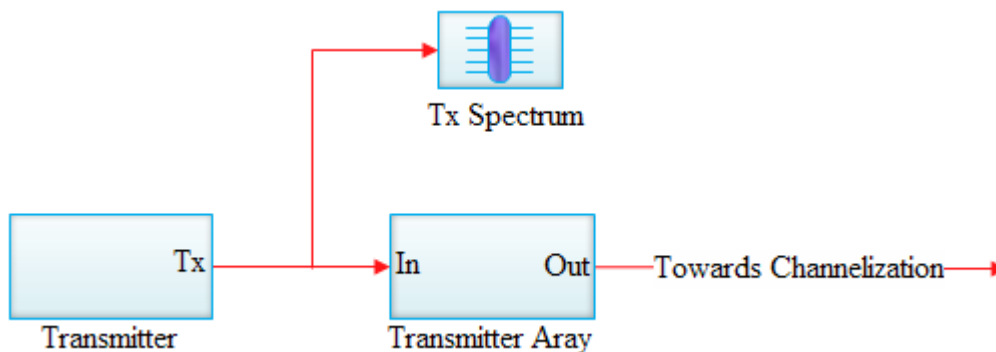

Figure 0.3: Transmission Path

While running the simulation, the desired direction of the transmission could be changed or reset to 22° to yield low power in the medium. When the receiving angle is changed or reset to a different degree, for example 90° , the power of the receiving angle increases, thus compensating for the power between 22° to 90° . When the receiving signal direction is set to 22° , the same as with the transmitting direction, the power also decreases. Subsequently, this integrates the channel and modulation techniques applied to the transmitter in order to forward a proper signal to the receiver.

5.4 Channel and Modulation Techniques Applied to the Transmitters

The channel and modulation techniques applied to the proposed model is a channel that supports the UWB system with high frequency and maximum data support through the channel for proper implementation of the proposed UWB-MAC. This study adapts the MIMO channel system in the implementation of the proposed model and combines the two possible techniques in the MIMO system that is, multiplexing and beamforming. The reason for integrating both techniques is that multiplexing increases the effective data rate by sending parallel beams of

data on different antennas at the same time, while the beamforming technique focuses on particular narrow angle/signal beams in the direction of the receiver, enhancing the signal reliability. The streams of multiplexing techniques in the MIMO system are represented by line of transmission patterns from the upstream to the downstream (in MANET from DEVt to DEVr). The channel is placed in-between the transmitting and the receiving ends which coordinate more of an angle of arrival and beamforming. Before arriving at the beamformer from the transmission channel, a UWB interfering signal is added to the desired signal. When running the simulation, changes can be made on the independent direction from which both the desired and interfering signals are received.

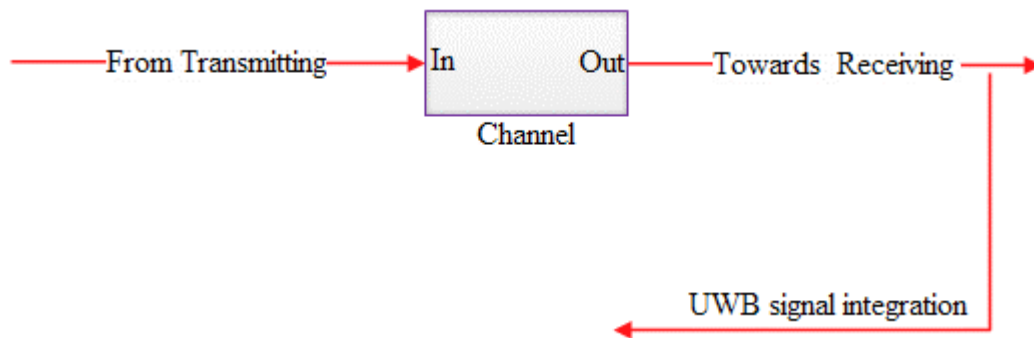

Figure 0.4: Channel Connection

The UWB channel controls the wide band signal and monitors the signal and arrival direction of the signal by combining the concept of beamforming and multiplexing. Figure 5.3 presents the UWB section of the PHY stack.

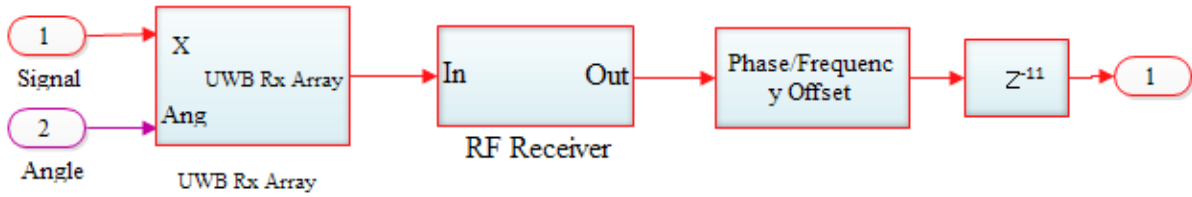

Figure 0.5: UWB Channel

The mathematical formulation of the MIMO channel has been used to increase the data rate and possibly transmit several information streams in parallel where a special multiplexing technique is applied. The transmitting and receiving sections of the channel can be presented in a vector spaces formulation and later converted into matrices.

T_x can be $\begin{bmatrix} x_1 \\ x_2 \\ \vdots \\ x_t \end{bmatrix}$ and is the T transmit sample across the channel and is also T-dimensional vector.

R_x can be $\begin{bmatrix} y_1 \\ y_2 \\ \vdots \\ y_r \end{bmatrix}$ and is the Receiving sample across the channel and is also R-dimensional

vector.

Therefore, the two vectors can be represented as an input/output system through the channel to represent the entire wireless channel as in:

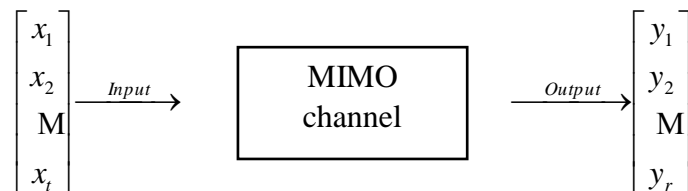

Equation 0.1: Input/output System of the MIMO Channel

The T-dimensional vector can be represented by \bar{x} and R-dimensional can be represented by \bar{y} . We can pass the input to the wireless channel which is the T_x vector through the MIMO channel to the output of the wireless system R_x vector ($\bar{x} \Rightarrow MIMO \Rightarrow \bar{y}$). Therefore, the MIMO channel transforms the T-dimensional vector into R-dimensional and this can be technically converted into a matrix. The matrix takes an input as T-dimension and the output to be R-dimension vector. The resulting equation of the channel model can be:

$$\bar{y}_{rxl} = H\bar{x}_{txl} + \bar{w}_{rxl}$$

Equation 0.2: Resulting Equation of the Channel Model

Where \bar{w}_{rxl} is the noise of the channel which is also informed of receiving a signal. H can be represented as r x t dimensional vector with a channel coefficient of:

$$H = \begin{bmatrix} h_{11} & h_{12} & \dots & h_{1t} \\ h_{21} & h_{22} & \dots & h_{2t} \\ \dots & \dots & \dots & \dots \\ h_{r1} & h_{r2} & \dots & h_{rt} \end{bmatrix}$$

Equation 0.3: Channel Coefficient of the Channel

The r-rows are the receiving signal while the t-columns are the transmitting signal. The coefficient of H as in $h_{i,j}$ (i,j^{th}) coefficient which means i^{th} row and j^{th} column are the channel coefficient that represents transmitting antennas of the DEVs in the wireless network. Therefore, $h_{i,j}$ is nothing but the channel coefficient between i^{th} receiving antenna and j^{th} transmitting antenna. The total number of channel coefficients in the wireless system is the product of receiving and transmitting signals ($r * t$). For example, $h_{3,2}$ is the channel coefficient of 3rd receiving DEV and 2nd transmitting DEV.

Section 5.6 describes the proper MB-OFDM channelization of the MIMO system with detailed integrating procedures of the proposed system. The section also presents the configurations and the specific output of the channel after implementing it in a simulation environment. After working on the transmitting and channel aspect, section 5.5 presents the receiver implementation.

5.5 Receiver Implementation

The receiver section uses a feedback loop and the block comprises an estimated angle of reception and beamforming algorithms that assumes the two signals are received. The root multiple signal personification (Music) algorithms are used. The block estimates two directions and each are processed to the control logic to decide the angle that provides the best modulation regression. The estimated angle is passed to another block of direction of arrival tool box that performs minimum value distortion less response. The block preserves the signal power at the given direction which supresses interference noise coming from the other direction. The beamforming angle determines the use of the control logic and the signal strength used to determine which of the two ways of estimated angle provided the lower modulation regression. The particular beamforming algorithm provides excellent tracking of the desired signal even when the interference signal is stronger than the expected signal.

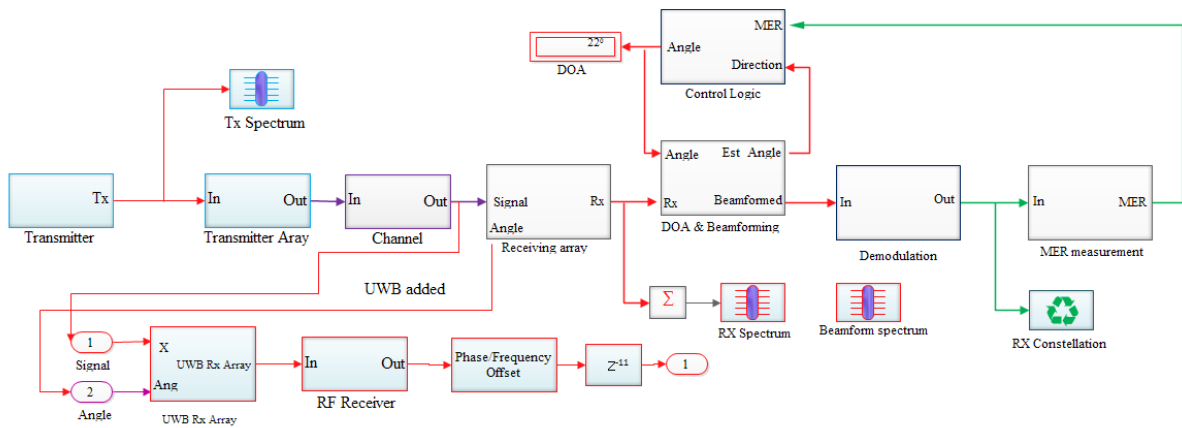

Figure 0.7: Complete PHY Stack

It is reasonable to elaborate further on the channel utilisation process and the reasons behind adopting MB-OFDM in the design process rather than other techniques. Section 5.6 elaborates more on the MIMO channel (MB-OFDM channel).

5.6 Multiband-OFDM Implementation on the MIMO Configuration

The choice of MB-OFDM for the implementation of the proposed UWB-MAC is based on its robust nature towards multi-path communication. It is easier to implement in terms of spectrum sculpting and the technique is less prone to interference in relation to other technologies like narrowband systems. Narrowband communication systems do not accommodate resilience with regards to high interference within their operational bandwidth limits. Series of data can be modulated using a Gaussian monocycle pulse train, as stated in section 3.12. It implies using pulse position modulation (PPM). The approach for the implementation is clearly stated in Table 4.2 with all the physical properties of the implemented channel. Figure 5.7 describes the output of the channels, symbols and sub-bands.

Basically, Figure 5.7 describes the MB-OFDM Physical layer with all the numbers of groups in the channel. The groups have 528MHz bands in four distinct groups.

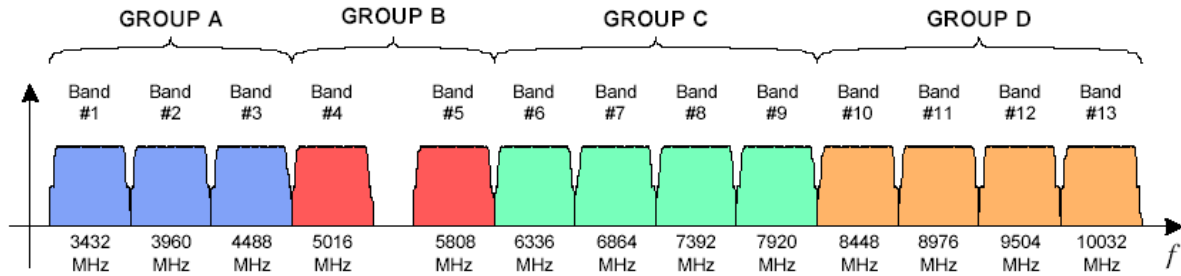

Figure 0.8: Multi-Band OFDM Physical Layer

The groups are as follows:

- i. Group A: is destined for the 1st generation devices and the frequencies range from 3.1 - 4.9GHz.
- ii. Group B: is reserved for future use and the frequencies range from 4.9 – 6.0 GHz.
- iii. Group C: is intended for devices with improved SOP performance with frequencies range from 6.0 – 8.1GHz.
- iv. Group D: is also reserved for future use with frequencies range from 8.1 – 10.6GHz.

Another consideration that prompted the use of the multi-band approach over other techniques like DS-UWB, is its high spectral efficiency inherent in OFDM and its high resilience to RF interference to other RF signals. Apart from robustness to multi-path effect by MB-OFDM as mentioned earlier, the standard is a proven technology used in an indoor environment like other wireless MAC standards for both PHY and MAC layers.

In Multi-Band OFDM (MB-OFDM), the approach divides the available UWB frequency spectrum of the channel (3.1 GHz to 10.6 GHz) into multiple, smaller paths and no overlapping

bands with bandwidths greater than 500MHz. The standard is similar to the narrowband frequency-hopping techniques, with more advantage of eluding transmission over certain bands.

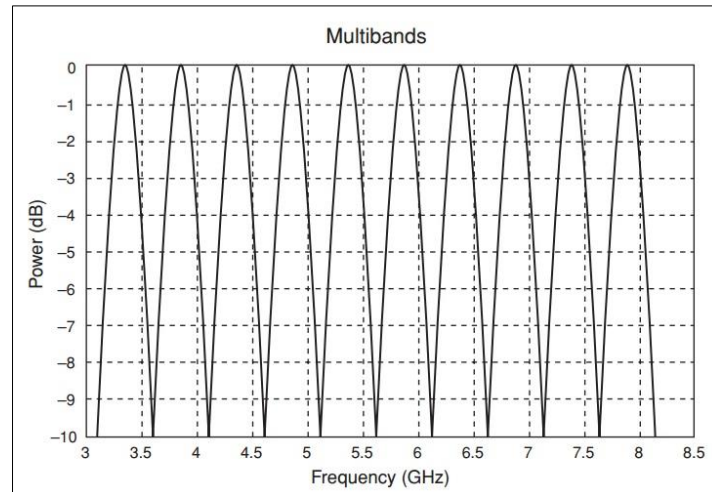

Figure 0.9: OFDM Modulation Pattern

The study revealed a maximum of 7.5GHz for UWB 5 channels and channels 1-4 have 3 sub-bands each while channel 5 has 2 sub-bands. In the channels, each sub-band occupied 528MHz. The OFDM symbol of the channel has 128 sub-carriers and can transmit each symbol for one time slot per channel. The concept of cyclic prefixing has been used to reduce the complexity of the reception (R_x) circuitry with multi-path resistance from a prefix of 60ns and the use of simple multiplication operations in place of Shift-Multiply-Add in frequency domain although strong consideration has not been placed on the time frame for each and every channel to switch between which is the Guard Interval (GI) and Closed Proximity (CP). However, the default of 9.5ns GI to switch between channels in the communication path has been considered. To avoid experiencing high latency and redundancy in the proposed UWB-MAC, average GI and CP values have been used and to refrain from complicated channel switching of hardware circuitry, the use of short GI has been avoided. Part of the targeted aim in the proposed UWB-MAC is

to decrease high overhead and accumulation of multi-path signal strength. Thus, larger CP adoption was not pursued, rather, an adoption of a CP duration of direct proportion to the delay spread in the channel.

The implementation of the MB-OFDM component of the proposed system involved MATLAB coding functions and graphical results are found by showing the Bit Error Rate (BER) of the system. The BER of the MB-OFDM for the entire system has been determined by plotting a Signal to Noise Ratio (SNR) as shown in Figure 5.9. The dispositions in sections 3.5 and 3.12 have been recapped. To achieve the alleged accurate localisation through the physical layer, BER is controlled in terms of declining to yield maximum throughput. Meanwhile, SNR is also controlled to yield maximum throughput. Moreover, these factors (BER and SNR) are major sources for energy inefficiency in MANET.

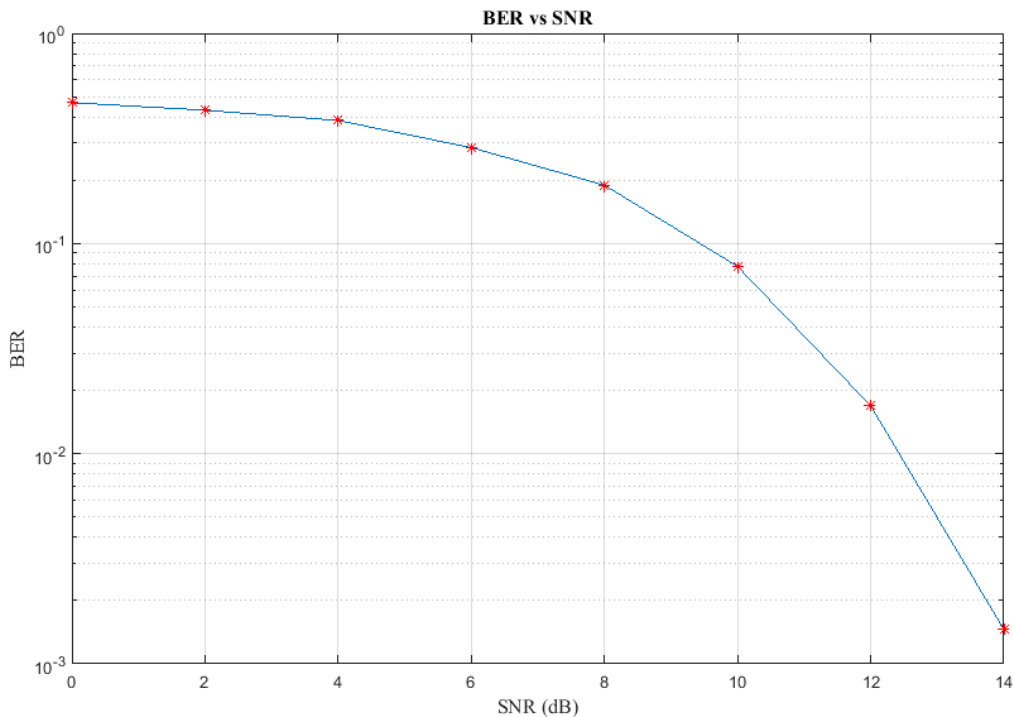

Figure 0.10: MB-OFDM BER vs SNR Implementation

Although the research work has succeeded in achieving the appropriate MB-OFDM channel as adapted in section 4.4 (Table 4.2), other details of the complete PHY stack are beyond the research study. The implementation code is in the appendix section as a reference. The complete PHY stack is linked to the UWB-MAC using the Asynchronous Power Saving (APS) model for implementation to save energy in the communication setup.

5.7 Asynchronous Power Saving (APS) Model

The proposed UWB-MAC adapts Asynchronous Power Saving (APS) techniques in transmission and reception because the techniques are more important than other standards and also enable long operation time for battery powered devices. The standard uses an effective method to extend battery life and enable devices to turn off completely or reduce power for long periods of time. The specified period of time for the standard to extend battery life is relative to the superframe duration. During the transmission or reception period, the standard offers two different power management modes for the devices to operate on: *active* and *hibernation modes*. The active mode transmits and receives beacons in every superframe in the communication medium, while hibernation mode is capable of hibernating multiple superframes that come as a result of cross communication, and therefore halts the communication process by dropping the transmitting or receiving frames in those superframes. Subsequently, the technique stretches capability to support devices that sleep for a particular portion of a superframe and that leads to maximum power saving by the protocol.

To specify the direction of transmission based on a specific angle of arrival, neighbours are co-ordinated by indicating the intention to hibernate and each device includes a hibernating mode in its beacon. The reason for the hibernating mode is to specify the number of superframes in process. This technique will save enormous amounts of energy by putting

non-active devices in sleep mode and thus, will not allow devices to send or receive beacons or any other frames. The operation mode of the proposed asynchronous power saving model is to operate efficiently only if the time spent in that model is greater than a certain threshold.

The major advantage of using the APS model in the implementation of the proposed UWB-MAC is to reduce contention in the communication medium due to the fact that nodes wake up at different time instances. Another benefit attached to using the APS model is that it allows each node in the communication environment to set its own sleep/wake schedule independently. Finally, using the APS model will support the devices to be in Asynchronous mode. They do not have to be synchronised together all the time. Section 5.8 presents the algorithm for the implementation of the APS for the proposed UWB-MAC with a steerable directional antenna system.

5.8 Asynchronous Power saving algorithm for UWB-MAC with Steerable Directional Antenna

The proposed UWB-MAC protocol algorithm is designed to ensure that, after issuing the RTS command in the transmission process, no member of the extended beacon group transmits a beacon frame at the same time as the device in order to avoid collision. Thus, in line with the algorithm steps, information included in beacon frames is designed to facilitate contention-free frame exchanges by ensuring that a device does not transmit frames while a neighbour is transmitting or receiving frames. To permit correct frame reception, the UWB-MAC protocol algorithm attempts to ensure that a device(s) is/are unique within the device's extended beacon group and direction of transmission is specified

otherwise the process will reinitiate for a certain number of times before terminating the process.

The strategy for the implementation of the proposed UWB-MAC with directional antenna based on the APS model is to enable all neighbours in the communication environment to have an overlapping time between their wake periods: the wake period constitutes a preamble and data frame in order to save more energy in the medium. The scheme has a transmitting and receiving mode as in Figure 5.10.

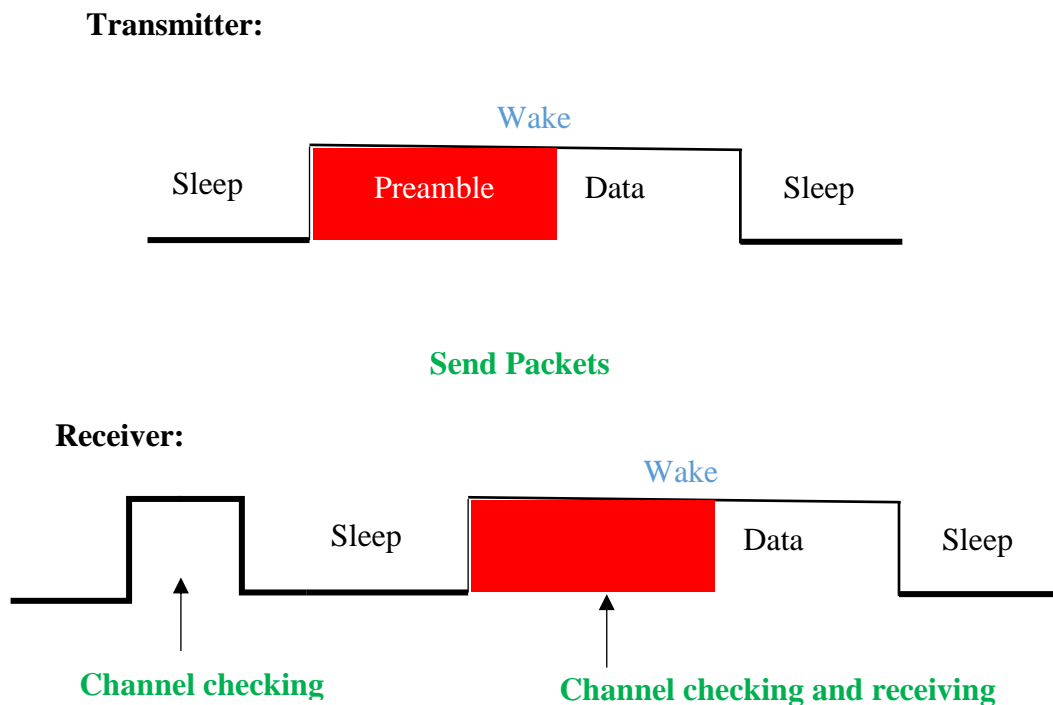

Figure 0.11: Asynchronous Scheme of the Proposed UWB-MAC

Item i): outline the transmitting algorithm and item ii): outline the receiving algorithm for the proposed UWB-MAC with steerable directional antenna system. The receiving mode has two additional checking modes for the protocol that is, checking the channel before transmitting and channel checking with receiving mode.

i. Transmitting and channel determination algorithm

1. Procedure Algorithm () UWB-MACpConSer Algorithm
2. Time = simulationTime do
3. using a directional RTS packet to transmit
4. is there a valid neighbour(s) within angleOfTransmission? and angleLessThan360⁰
5. If (PT_x >= minx) OR (PR_x >= MinR_x) then
6. Transmit data → yes
7. else
8. Initiate another transmission process with different angle < 360⁰
9. Is there any blockage or hidden node(s)?
10. If yes then
11. Hibernate non-active devices by putting them on sleep mode
12. Put the channel in idle direction mode
13. If No then
14. Perform line 7 and go to line 3
15. Else
16. Is the channel free to transmit?
17. If yes
18. Transmit with full UWB channel capacity
19. Else
20. Put the channel to idle sensing mode
21. Successful transmission

ii. Receiving and channel determination algorithm

1. Procedure Algorithm () UWB-MACpConSer Algorithm
2. Time = simulationTime do
3. using a omni-directional CTS packet to transmit
4. is there a valid neighbour(s) within angleOfReception? and angleLessThanOrEqual360⁰
5. If (PT_x >= minx) OR (PR_x >= MinR_x) then
6. Transmit data → yes
7. else
8. Initiate another transmission process with different angle =< 360⁰
9. Is there any blockage or hidden node(s)?
10. If yes then
11. Hibernate non-active devices by putting them on sleep mode
12. Put the channel in idle direction mode
13. If No then
14. Perform line 7 and goto line 3
15. Else
16. Is the channel free to transmit?
17. If yes
18. Transmit with full UWB channel capacity
19. Else
20. Put the channel to idle sensing mode
21. Successful transmission

5.9 State-based Energy Consumption Model

The state-based energy model describes how the general MAC protocol transmits and receives packets from one point to another. Basically, there are seven states in a given communication path that take place at the MAC layer: the start, transmission, reception, idle, sleep, initial disconnection and stop, although there are other ways of describing the communication process in a MAC stack. The concept of state-based techniques has been used to describe the behaviour of the proposed UWB-MAC with the directivity concept using a steerable directional antenna. Figure 5.12 presents the general state-based diagram with traces of links between states and all states are mutually dependent.

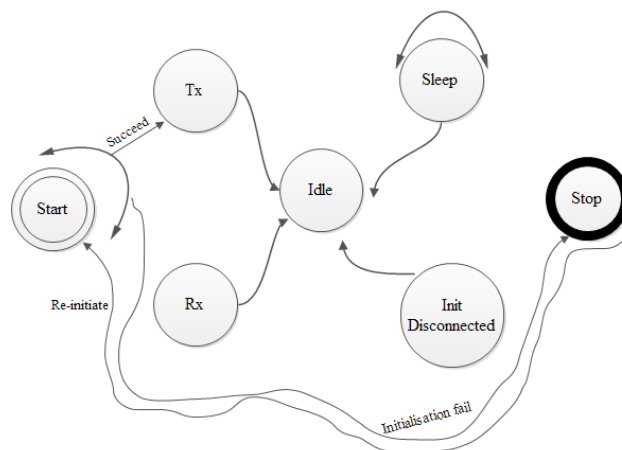

Figure 0.12: General State-based Model

Figure 5.13 shows the graphical representation of the state-based diagram with current/power/energy against time taken for either transmission or reception to take place. The Figure expresses the receiving states of the proposed communication protocol and it is assumed that the transmission process is also a reproduction of the same graph but it starts with the transmission state instead of the receiving state. T_1 is an initial state which represents either the receiving or transmitting state followed by T_2 for active or idle states. It is proposed that the protocol starts optimisation process at T_3 where both the PHY and MAC stack apprehend the

matrices involve in order to calculate the energy consumed at the MAC layer based on the proposed model.

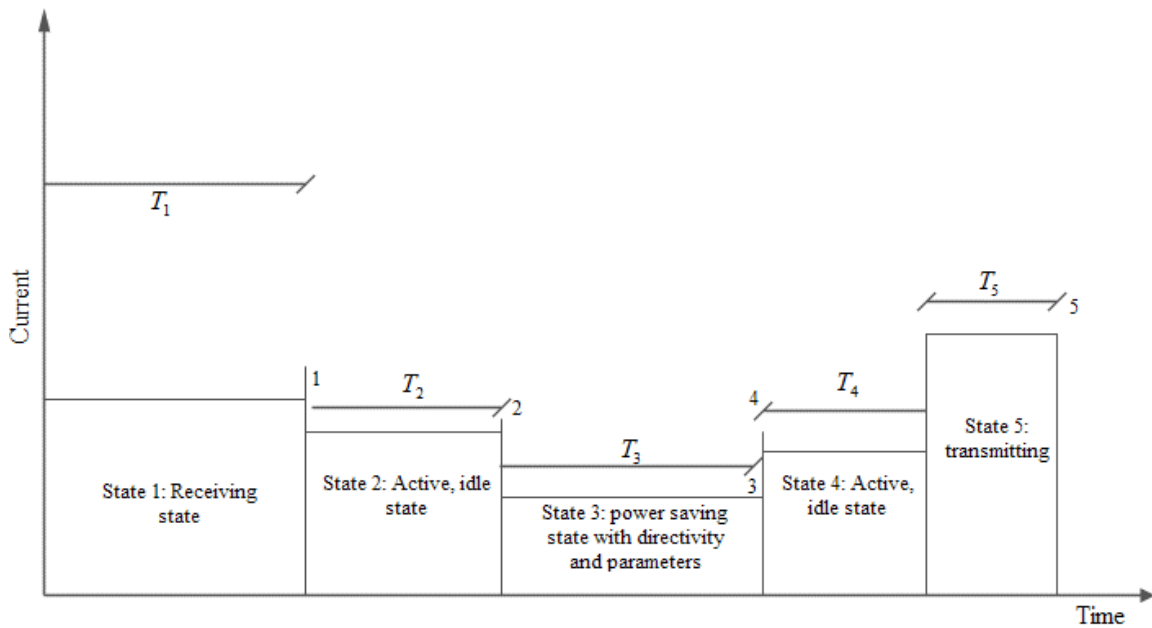

Figure 0.13: Graphical Representation of the Proposed State-base UWB-MAC

T_4 will also set the channel in either an active state, if there is immediate transmission or reception in place, or in an idle state, if there is process in the channel. The final state is T_5 where the process ends by either transmitted/received or in some cases, packet drop due to some disputes like hidden problems, overhearing and the like.

From Figure 5.14, the directivity state is introduced to modify the transition process and the directivity state serves as an interlink between transmission and reception. The introduced link will determine how energy can be saved based on matrices defined at the PHY and MAC layer of the communication process. The MAC layer deals with energy optimisation entities that is, data rate, density, distance, propagation channel, antenna height and direction of transmission as stated in the framework. Whilst at the PHY layer, the second part of the model specifically deals with antenna efficiency, directivity and antenna height.

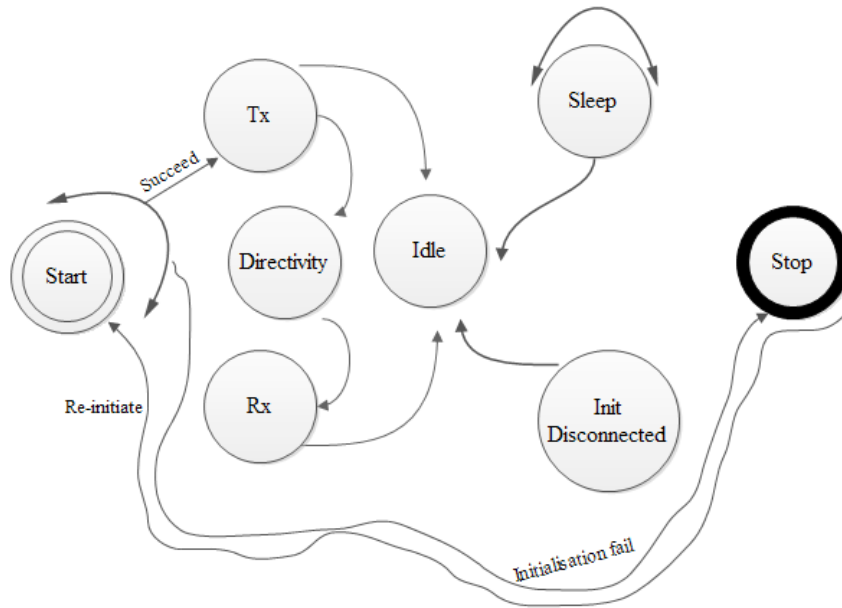

Figure 0.14: Simplified State Diagram of the Proposed UWB-MAC

5.10 State-based Energy Saving Schematic Algorithm for the Proposed UWB-MAC

Based on the modified version of the proposed state-based energy model in Figure 5.14, the proposed UWB-MAC is further elaborated upon by expanding the algorithm and extending communication states with idle pattern before placing the protocol into sleep mode. That means, if the protocol is in a wake state, then, it is either in sensing mode and focusing to a specific direction, processing, transmitting or receiving mode. The opposite state will halt the protocol by placing it in a sleep mode after interposing with idle sensor, idle direction, idle processing, and idle radio. Figure 5.15 presents the full description of the algorithm.

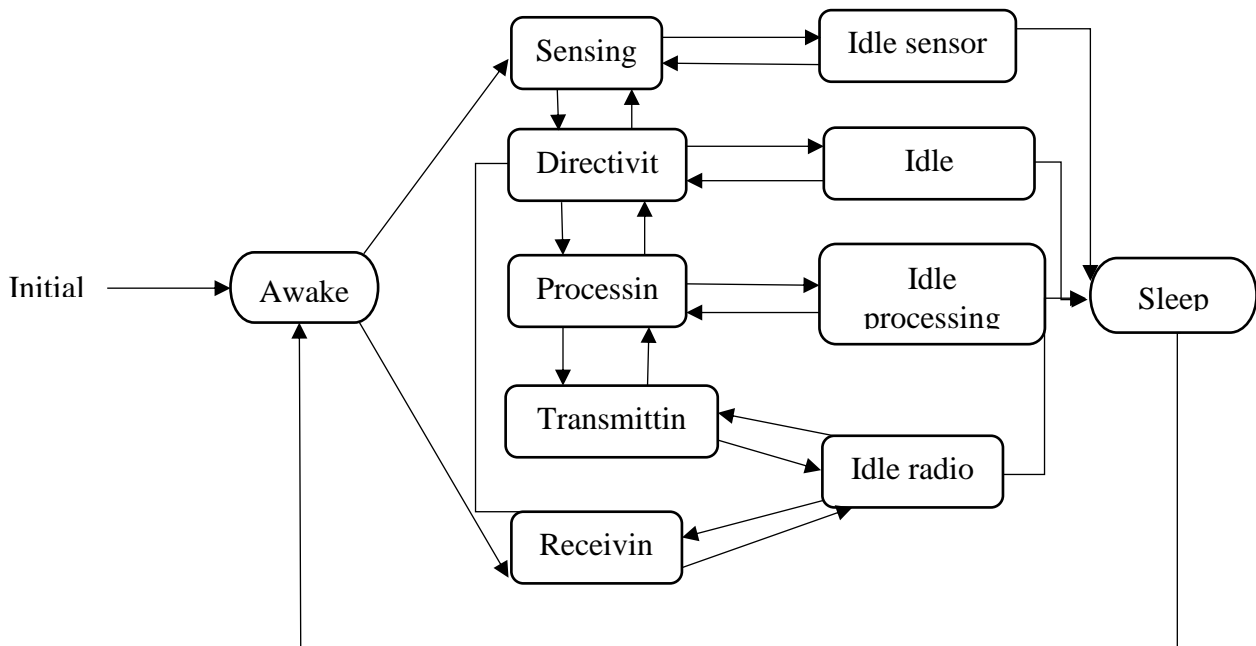

Figure 0.15: State-based Energy Saving Algorithm for the Proposed UWB-MAC

In the proposed protocol, data is requested through the channel by using Information Elements (IE) and the actual data is sent after locating a specific direction in the form of bursts of the MAC Protocol Data Units (MPDU) with a Prioritised Channel Access (PCA). The PCA will issue either an Enhanced Distributed Channel Access (EDCA) used by generic MAC protocols or it will utilise a Carrier Sense Multiple Access with Collision Avoidance (CSMA/CA). The UWB-MAC PCA uses a Short InterFrame Space (SIFS) at the end of each MPDU to link the upper layer for proper communication. The minimum InterFrame Space (MIFS) in the UWB-MAC is between two consecutive burst frames. The PCA has a soft reservation policy in order to burst an inferior quality of service in the Network.

The directivity states in the state-based diagram (directivity and idle direction) are employed so that the problem of network availability and system throughput can be alleviated and it allows continuity of communication with the receiving palm pilot device without impacting

the communication between immediate devices. Consequently, it will provide the protocol with a spatial and connectivity isolation not found when using an omni-directional antenna system.

5.11 Chapter Summary

The chapter presents an overview of the framework, implementation and algorithm of the proposed UWB-MAC with directional antenna system. The proposed framework of the protocol is based on the OSI model architecture from application to the physical layer. The main focus is on the PHY and MAC layer. The chapter also describes the implementation procedures on transmitter, channel and receiver sections of the proposed system. Multi-Band orthogonal frequency techniques are also discussed and how they are implemented in the proposed system. The Asynchronous Power Saving model and its algorithm are described. The model can be used to study the effect of filtering, image rejection mismatch and possible differences in-between the changes. This model also affords a starting point to the exploration of the effect of RF architecture in wireless communication. The chapter is concluded with a state-based energy model and a schematic algorithm for the implementation of the proposed system.

Chapter Six

6.0 Simulation

6.1 Introduction

This chapter presents detailed solutions of the simulation process that validate the analytical concepts in chapter four and the framework, algorithm and implementation process in chapter five. An overview of the simulator (ns-3) is also presented and the way in which the accomplishments of the simulation have been executed. Two simulation parameters are highlighted in Tables 6.1 and 6.2 for the existing and proposed models respectively. Results of the scenarios are captured based on matrices like network saturated performance throughput, collision rate, packet delivery ratio, average channel delay and total energy consumed. Based on the results obtained, discussions took place on each and every metric to study the difference between the existing and the proposed models. The results are also compared with other results from literature to prove the foundations of the work in existing literature and understand its contributions. A concluding summary is presented that gives a clear picture of the chapter.

6.2 Overview of Network Simulator-3 (NS-3)

Network Simulator-3 (NS-3) is a discrete network simulator so that the core and model are implemented in purely C++ language. The library of the simulator is built in a form of static and dynamic links which support C++ programming language. This concept defines topology of networks and initiates the simulator. NS-3 executes a sequence of codes by exporting all of its API to Python and therefore, this allows the Python programs to import the NS-3 module and convert it to NS-3 library. The series is executed by linking the library to C++ platform. The organisation of the source code is placed in the *src directory* and the software organisation can be presented in a diagrammatic form. The simulator basically has a six-layer structure from

bottom to top which comprises: core, network, internet/mobility, protocol, helper and finally, testing layer. In general terms, the simulator is categorised to be distributed as source code. Simply, it is a platform that has a software development environment which starts with building libraries before building the user program. The development environment of NS-3 simulator is a Linux or Linux-like environment, although windows platform (Cygwin) does support it with some limitations in terms of the optimised process and output.

The simulator is designed to provide an open and extensible network simulation platform for those involved in networking research and other educative research activities. In a network research perspective, it provides models and processes on how data packets work in an easily simulated engine to conduct an optimistic research work. The main advantages of using NS-3 simulators are to study a complex setup which cannot be executed in a real life scenario, to learn the architectural behaviour of networks in a responsible and highly controlled environment and to study how computer networks function. The simulator toolkit is a set of libraries that can be linked together with other external software libraries like MATLAB to serve as a single and integrated graphical user interface for all tasks to be carried out systematically. The basic conceptual terms in the NS-3 simulator are nodes as basic computer devices to which one may configure some attributes (e.g. applications, protocol stacks and peripheral cards), and specific applications that run on devices, be it system or application software with a class application (e.g. like UDP protocol to be `UdpEchoClientApplication`). Other conceptual terms are channel with a class channelled which provides strategies for managing communication in the medium by connecting different devices in the network, and Net Device as an interface device that connects ordinary computers to the network. It uses a class device or `NetDevice` function for executing it. The `NetDevice` class is responsible for connecting nodes through the channel.

The NS-3 supports different network topologies and uses different models and attributes like the bus network. The reason for implementing the proposed model in NS-3 is that the CSMA device models are simple networks in the spirit of Ethernet. Subsequently, with regards to wireless sensor networks, different models provide a set of MAC models that attempt to provide as accurate MAC-level specifications and implementation as possible. To generate an output for the design for study, two basic strategies can be used namely, generic pre-defined bulk output mechanism or developing an output mechanism that conveys the specific information needed. Preferably, the generic pre-defined bulk method is recommended because it does not require much change to NS-3 and scripts are written to parse and filter the required data. Tracing is also another mechanism in NS-3 used to avoid some of the problems inherited in the bulk output mechanism by reducing the amount of data enquiry and tracing the events of interest only.

Data collection in NS-3 is through generating output data for research purposes or for the study of the behaviour of the developed system. Apart from the trace file generated data, other things the trace file generates include: non-packet data like protocol state machine transition, large simulations setup and data reduction or computation during the cause of simulation. The non-packet data is the data that is generated which does not map well to PCAP or ASCII traces while the data reduction or computation defines termination conditions when enough data has been achieved for analysis.

6.3 Simulation Parameters

An extensive simulation is conducted for validating the proposed UWB-MAC power conservation model. The comparative performance study of the proposed UWB-MAC in MANET is executed in the NS-3 simulator as explained in section 6.2, together with an overview of the simulator. The simulation parameters are outlined in Tables 6.1a and 6.1b with parameter names and values. The total number of nodes used for the scenarios created is 30 nodes randomly in a mesh network topology with an area of 200m x 200m environment. The allocation were made between 10 – 30 nodes (scenario with 10nodes, 20nodes and 30nodes), the 30nodes scenario produces a stabled result. The establishment of 200m x 200m is based on the formula in [112] that gives the exact square metres required to deployed a network in a specific location. In the preliminary testing of the proposed model after conducting the literature search in section 3.7 and before the modification and analytical analysis, there are changes compared to using the NS-3 simulator. This is because some parameters were considered which were in contrast to the QualNet simulator; like data rate and power management technique. The real PHY layer is called from MATLAB tool to NS-3 simulator which is linked with the MAC layer for proper implementation.

Table 0.1: (a) Parameter setting for UCAN standard with Omni-Directional Antenna

Omni system	
Parameters	Values
Number of Nodes	30
Antenna type	Omni
Antenna gain	0dBi
MAC	IEEE802.15.3
Antenna range	200ms
Mobility	Random mobility way point
Propagation channel frequency	9.14×10^8 Hz
Path loss model	Two ray
Modulation	QPSK
Frequency	2.4 GHz
Transmission power	7dBm (with maximum of 13dBm)
Receiver sensitivity	-82dBm for QPSK
Routing Protocol	TORA
Transport protocol	TCP and UDP
Data rate at PHY layer	11Mbps (11Mbps to 55Mbps)
Power management mode	APS and DSPPS
VoIP	Generic

Table 6.1: (b) Parameter setting for proposed system with Directional Antenna

Proposed System with Directional parameters	
Parameters	Values
Number of Nodes	30
Antenna type	Steerable directional
Antenna gain	14dBi for directivity
MAC	IEEE802.15.3
Antenna range	200ms
Mobility	Random mobility way point
Propagation channel frequency	9.14×10^8 Hz
Path loss model	Two ray
Modulation	QPSK
Frequency	2.4 GHz
Transmission power	7dBm (with maximum of 13dBm)
Receiver sensitivity	-82dBm for QPSK
Routing Protocol	TORA
Transport protocol	TCP and UDP
Direction Gain	10.0db
Directional NAV Delta angle	22.5degrees
Data rate at PHY layer	11Mbps (11Mbps to 55Mbps)
Power management mode	APS and DSPPS
VoIP	Generic

The simulation time is 140sec and assumed to be in a real-life connection. A number of three repeated iterations are made on the scenarios created to enable the simulation to obtain accurate results. The steerable directional antenna properties of the wireless nodes for both the existing and proposed UWB-MAC are fortified with antenna arrays of 7 and 16 elements; this is equivalent to 55.5° and 22.5° beamwidth respectively. The directivity gain of the steerable antenna system in the communication medium is limited through power management mode used to provide omni-directional standard. The distance of the transmitting rate is assumed to be constant because it has been tested in section 4.6 using numerical values and therefore, the researcher ignored testing the difference in using multiple range scenarios for validation. Transmitting nodes use a poison traffic standard to generate sensing data at different rates with respect to packet size from 0.25 packets/sec to 4packets/sec. The packet size is 127bytes and is transmitted at 915 kb/s.

A Temporary Ordered Routing Algorithm (TORA) is used for validating the algorithm due to its hybrid nature where the protocol serves either as reactive or proactive. However, no emphasis has been placed on studying the performance of routing in this research study nor on validating the connection between networks and the MAC layer.

6.4 Results and Discussions

The scenarios are created based on clusters of ad hoc networks, which involve large numbers of mobile devices covering large areas. They use self-organising techniques as described in section 2.3 for message hopping through the entire network. Two types of traffic are verified respectively, a multi-hop topology with data packets and VoIP application. The basic scenarios created for evaluating the design process are data traffic and VoIP traffic with sub-scenarios for the existing and proposed models. The use of generic VoIP technology (G.711) is adopted for voice calls without mitigating the variation of codecs.

A priority scenario is created to study the total consumption with two different power management modes that is, a scenario with Asynchronous Power Saving (APS) and Device Synchronous Power Saving (DSPS) mode for both data traffic and VoIP application.

A scenario for the state-based energy consumption model is created to study the behaviour of the proposed and existing MAC from start, transmission, reception, idle, sleep and stopping state as described in section 5.10. The schematic algorithm described the process of achieving the use of directional antenna using the CSMA/CA techniques. The scenario is integrated with other scenarios to get the actual amount of energy consumed in the communication medium. The evaluating metrics of the existing and proposed scenarios are saturated performance throughput, collision rate, average channel access delay, packet delivery ratio and the total energy consumption. The algorithm is assumed to be fast adapting in connecting mobile nodes for localisation and other stacks like routing. However, the study is not designed to explore the performance of the routing protocol used for any of the scenarios.

6.4.1 Saturated Performance Throughput

The saturated throughput is determined as the maximum increase in density of a system that has reached its maximum limit. The evaluation of a saturated throughput is measured under overload conditions like the transmission queue of every node in the communication medium. The assumption made from the beginning of the research study proved that a reasonable amount of bandwidth overhead provided by IEEE 802.15.3 piconet, and the high data rate provision, are acceptable to deliver the proposed protocol. The throughput achieved by the proposed model, as compared to the existing model, is obvious for both data traffic and VoIP in Figure 6.1 for both access mechanisms. The proposed model achieves the higher saturation throughput with respect to change in density. However, when the system is set to use the VoIP application, it is clear that the throughput difference is not as great as when using data traffic.

Additionally, there is a minimum number of nodes resulting in insignificant difference between the existing and the proposed models. Table 6.2 presents the minimum, maximum and difference values for the saturated performance throughput which shows how the proposed model performs excellently compared to the UCAN approach.

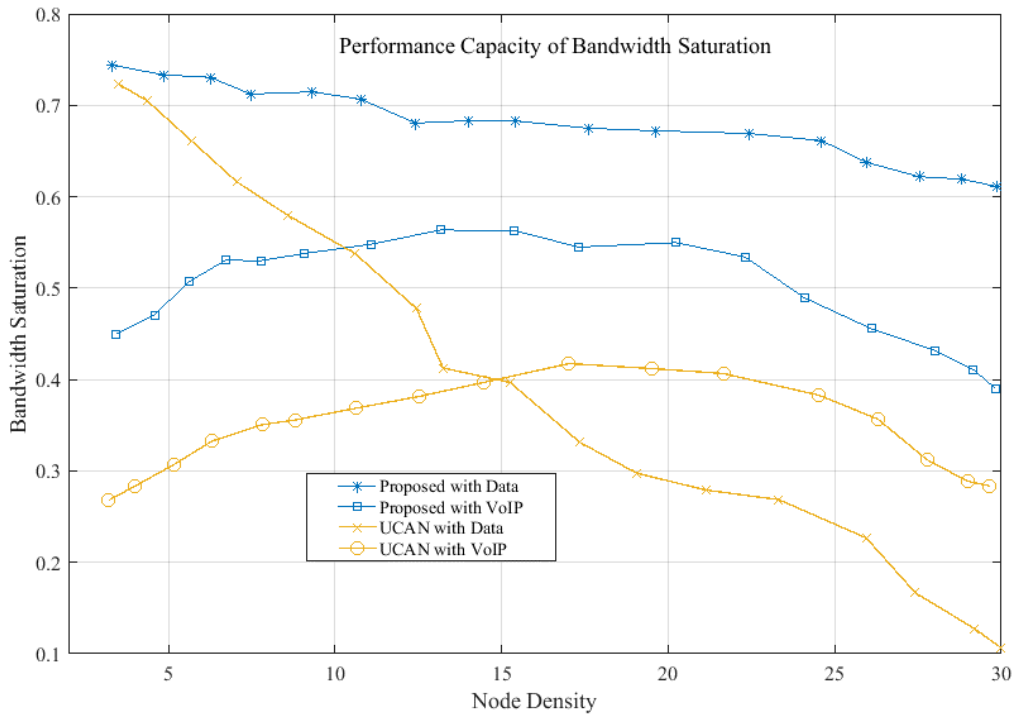

Figure 0.1: Saturated Bandwidth Throughput for all Nodes in Active Mode

The saturated bandwidth throughput results for the proposed directional UWB-MAC in Figure 6.1 (based on node density loaded with CBR and VoIP traffic) indicates a better result compared to the results in [113]. The researcher considered using IEEE 802.11 standard in which the rate of deafness, exposed terminals and hidden terminals cannot be addressed optimally. However, the proposed Directional UWB-MAC addresses these problems more than the DSDMAC concept and this yields a significant increase of about 7%. Increase in the number of nodes (density) has no significant difference in throughput by the proposed model with regards to both data and VoIP traffic from 0.76 to 0.61 compared to the existing model

with a throughput decreasing from 0.74 to 0.1. Similarly, considering the VoIP application, the proposed model was not affected seriously by the increase of the network density compared with the existing MAC protocol. Therefore, in general, the proposed directional UWB-MAC performed extremely well in a dense network compared to the existing MACs. The saturated performance throughput measured the quality of service (QoS) in the network. This shows that the proposed model's level of service delivered between devices in the network is superior to the existing model.

Table 0.2: Saturated Throughput Performance for Minimum and Maximum Percentage Difference

Saturated Throughput Performance				
<i>Model</i>	<i>MinValue</i>	<i>MaxValue</i>	<i>%MinDifference</i>	<i>%MaxDifference</i>
Proposed DUWB-MAC with Data	0.6113	0.7439	13%	83%
UCAN DUWB-MAC with Data	0.1067	0.72		
Proposed DUWB-MAC with VoIP	0.39	0.56	31%	27%
UCAN DUWB-MAC with VoIP	0.2679	0.41		

Considering the percentage difference between the initial (Minimum) and final (Maximum) state of the communication level in Table 6.2, the throughput difference at the initial state is 13%. This indicates that all the models behave in the same way at the starting point with regards to quality of communication. As the density increases up to the finishing level, the difference is relatively high with a mark of 83% difference when running data traffic. However, in VoIP traffic, the maximum level difference is not up to that of data traffic. However, there is still a difference of 31% at the minimum and 27% at the maximum level marked which is also an apparent difference.

6.4.2 Collision Rate

Collision rate is determined by the total number of nodes that are attempting to transmit data packets at the same time and through the same channel. The channel will disregard the data

packets from all the nodes and retransmission will occur which leads to lower quality of service, low delivery ratio and high energy consumption within the communication setup. Collisions in the communication medium are minimised with the proposed UWB-MAC using a backoff transmission method whereby a transmitting device uses a specific random time in sensing the idleness of the medium before transmitting. This is done by allowing the MAC to use Clear Channel Assessment (CCA) capabilities to study the activities in the medium whether the channel is busy or idle. With these considerations in mind while designing the proposed MAC, the results indicate that the proposed UWB-MAC performs better than the UCAN MAC.

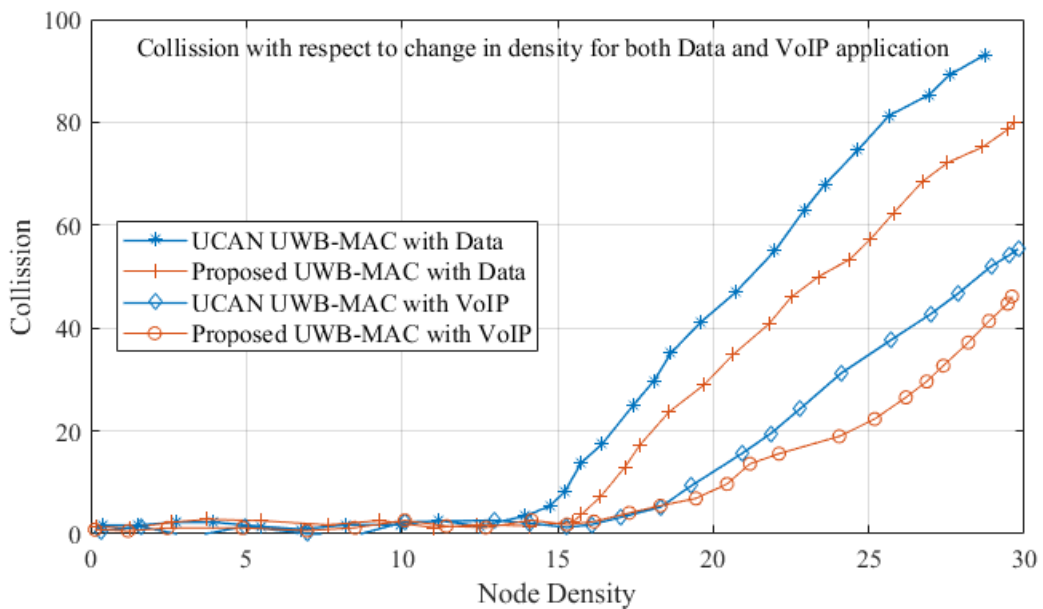

Figure 0.2: Collision Analysis for both Proposed and Existing Model

Table 0.3: Collision Rate for Minimum and Maximum Percentage Difference

Collision Rate				
Model	MinValue	MaxValue	%MinDifference	%MaxDifference
UCAN DUWB-MAC with Data	0.9025	93.12	20%	14%
Proposed DUWB-MAC with Data	1.134	79.98		
UCAN DUWB-MAC with VoIP	-0.5288	55.37	19%	17%
Proposed DUWB-MAC with VoIP	0.5712	46.14		

The simulation time is 140sec therefore, collision is obtained by dividing the total number of collisions in the medium by the total time taken. In addition, it can be noted in the density of the network which proves that, as the network stabilises when the number of participating devices exceeds fifteen, the collision level is between 0 to 4 but as the density increases, so too does the collision level. This shows that a high number of devices in the network affects the performance in terms of collision. In the proposed Directional UWB-MAC, a high antenna sector is used which increases the throughput as shown in Figure 6.1, and this decreases the rate of collision in the communication medium. Table 6.3 shows that, at the minimum level, the percentage difference is 20% for data traffic but at the maximum level, the percentage decreases to 14%. This indicates that, both at initial and final communication levels, the proposed model performs more effectively than the UCAN MAC. Subsequently, VoIP traffic also outperformed the UCAN approach by 19% at the initial stage and 17% at the maximum level.

6.4.3 Average Channel Access Delay

The results for average channel access delay, with respect to the number of nodes participating in the sessions and the number of outgoing packets rate, are presented in Figures 6.3 (a) and (b). These are the average values of delivered packets recorded during the simulation, minus the generated packets recorded for delivered packets through the channel. From the Figure, it is clear that the performance of the proposed model, with a directional antenna system, enhances the existing Omni system and the existing directional mode. This is because it is believed that the directional system uses less time in idle mode after receiving RTS/CTS packets from neighbouring nodes. Another factor is that the unused sectors of the antennas were blocked for a period of time and allowed transmission to take place with active sector. This normally increases the spatial re-use of the channel which provides better performance in

the network. However, the proposed model was not tested with omni-directional mode because it is a kind of repetitive experiment.

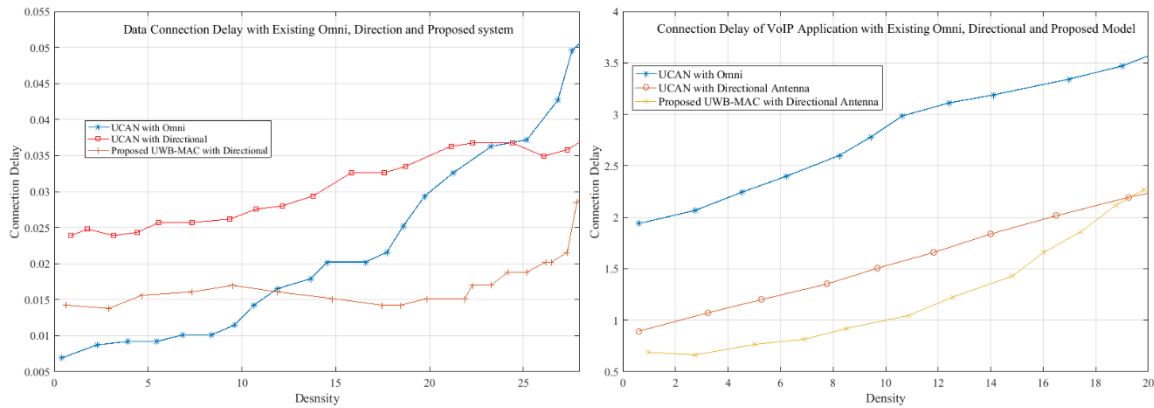

Figure 0.3: (a),(b) Connection Delay with data and VoIP using Omni and Directional Antenna

In Figure 6.3(a) of data traffic, the channel connection delay is higher by the proposed algorithm at the initial state. As the number of nodes increases when the network stabilises, the delay began to decrease with a maximum clarity in the graph. This shows that the UCAN algorithm produces a longer delay as the number of nodes increases. However, in the VoIP scenario from the initial state, the delay is less compared to the existing algorithm and continues to grow as the density increases. On an average output of the two models in both data and VoIP traffic, the proposed MAC performs better.

Table 0.4: Channel Access Delay for Minimum and Maximum Percentage Difference

Channel Access Delay				
Model	MinValue	MaxValue	%MinDifference	%MaxDifference
UCAN with Omni	1.939	4.158	-	-
UCAN with Directional	0.8929	2.474	35%	8%
Proposed with Directional	0.6633	2.27		

The high delay rate, demonstrated by the UCAN algorithm, predicts that there is a greater number of hidden terminals which the RTS/CTS operation of the nodes for transmission and

reception are difficult to adjust in the NAV duration field value during the channelization process. The proposed algorithm uses the directional NAV delta angle to cater for interference due to other frequencies which help the algorithm in adjusting the NAV duration value to yield maximum throughput and to reduce delay in the channel as described in section 3.12 in the earlier chapter. Another assumption made for the high initial delay by the proposed algorithm before the stability of the network is that, at the initial stage, the proposed algorithm experiences deafness because of the directivity standard which causes some RTS/CTS drop.

The percentage difference, with regards to the decrease in connection delay between the two models, is about 15.7%. Therefore, the proposed directional UWB-MAC performs better than the UCAN approach with about 34.3% in a highly dense network. Another advantage of spatial re-use in the proposed system in reducing the amount of delay is that extra overhead is rejected which also increases the throughput and strengthens the performance of the protocol. This is unlike using the omni-directional antenna where extra overhead is added and the communication becomes heavy.

However, Table 6.4 highlights the percentage difference at the minimum and maximum level of communication area, and this indicates that the differences is clear with 35% and 8% at minimum and maximum levels respectively. Directivity plays a vital role in reducing delay in the proposed directional UWB-MAC.

6.4.4 Packet Delivery Ratio

The Packet Delivery Ratio (PDR) is measured by determining the number of Constant Bit Rate (CBR) streams used in the network. It is measured through implementing the two applications used that is, data and VoIP traffic by the traffic source and traffic sink in the network. The two applications are tested using omni-directional and directional modes, and the results in Figures 6(a) and (b) indicate that the proposed model performs better compared to existing systems

after computing the ratio between the number of data packets received by the destination and the number of packets transmitted by the source nodes. Table 6.5 shows the percentage difference of packet delivery ratio for both data and VoIP traffic at minimum and maximum levels. The difference in using omni-directional and directional antennas for both the models is 11% and 30% respectively at the minimum level for data packets and 10% and 20% are marked respectively at the maximum level for omni and directional antenna usage. The proposed model outperformed the UCAN model with numerous differences in terms of packet delivery in the medium.

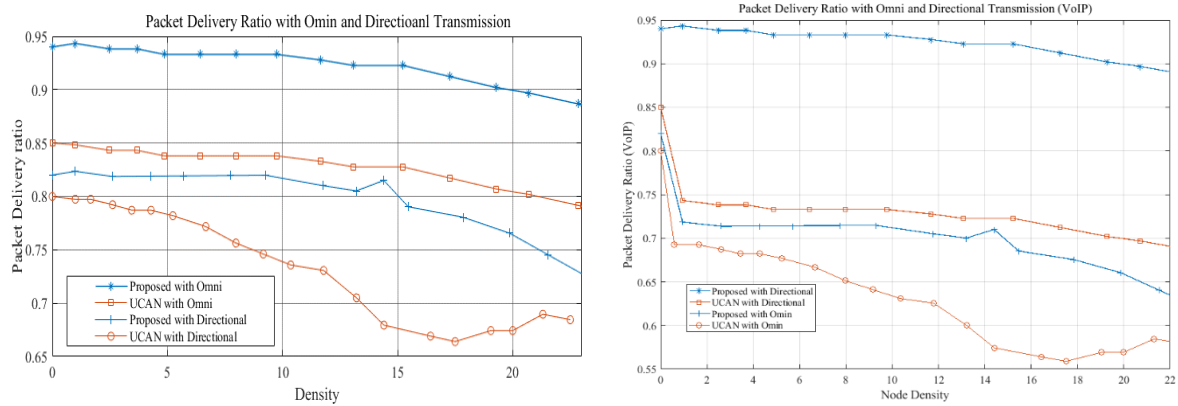

Figure 0.4: (a),(b) Packet delivery Ratio with Data and VoIP using Omni and Directional Antenna

Table 0.5: Packet Delivery ratio (data and VoIP traffic) for Minimum and Maximum Percentage Difference

Packet Delivery Ratio with Data				
Model	MinValue	MaxValue	%MinDifference	%MaxDifference
Proposed with Omni	0.8454	0.8454	11%	10%
UCAN with Omni	0.7504	0.85		
Proposed Directional	0.6448	0.82	30%	20%
UCAN with Directional	0.664	0.80		
Packet Delivery Ratio with VoIP				
Model	MinValue	MaxValue	%MinDifference	%MaxDifference
Proposed with Omni	0.8454	0.9433	24%	11%
UCAN with Omni	0.6454	0.85		
Proposed Directional	0.5398	0.82	30%	20%
UCAN with Directional	0.559	0.800		

Apparently, when using VoIP application, the difference is clear for both omni-directional and directional antenna systems. The initial difference is 24% for omni and 30% for directional, while the maximum difference is 11% for omni and 20% for using directional antennas.

The proposed model maintained standards in both data and VoIP traffic irrespective of heavy application and in a dense network, where the UCAN performance is reduced drastically for successful packets delivery. In a low density network, where the number of nodes is less than ten, and when both protocols are in omni standard, the packet delivery ratio follows the same pattern. Nonetheless, the proposed MAC performs well when compared to the UCAN in omni and directional modes. The proposed system is favoured through the use of spatial use techniques where fewer collisions occur because of the directional property attributed to the system. This increases the performance of the system as the high antenna sector is used for the implementation of the protocol.

6.4.5 Total Energy Consumed

The total energy consumption is tested for the overall network while running the simulation. The energy model is installed on each and every device in the network and each device is assumed to have a number of states as described in sections 5.10 and 5.11 for the state-based energy model. It is designed such that in any state changes, there will be a notification state to the energy source to update the current draw from the device. The operation of the two protocols shows that the proposed system performs better than the existing MAC for both data and VoIP applications. In Figure 6.5, APS mode is used for both data and VoIP in conjunction with state-based systems. The simulation is set up to run for 140sec in an interval of 20sec and the network stabilised between the time interval of 0 -37sec with higher energy of 940 – 990joules for all the scenarios.

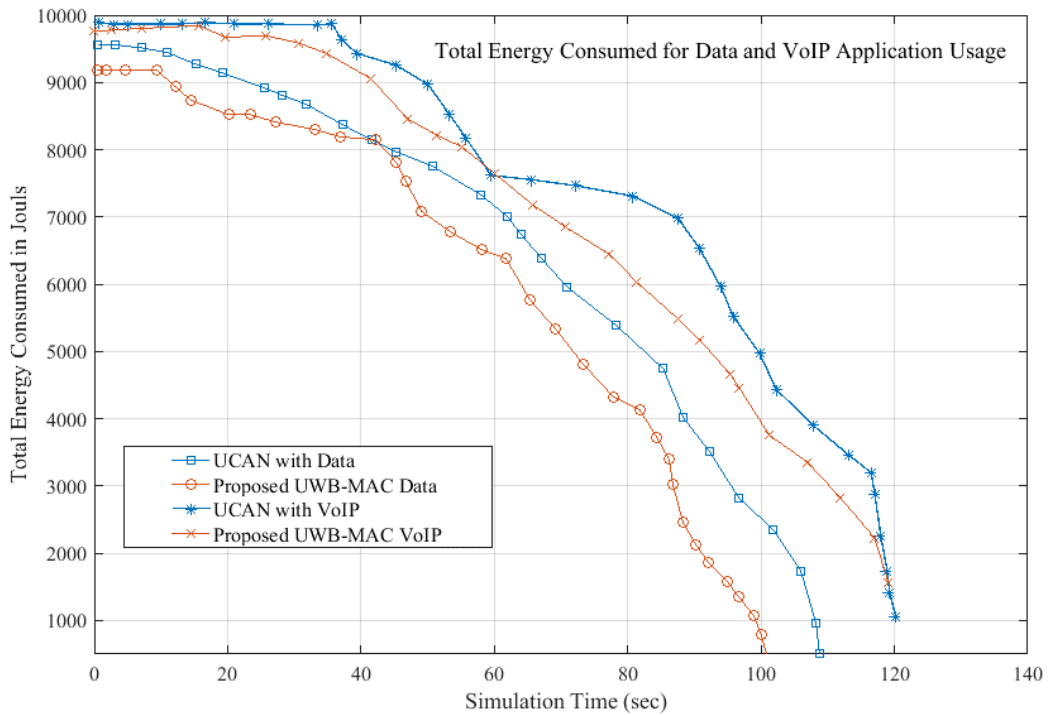

Figure 0.5: Total Energy Consumed in Joules with Data and VoIP

Both protocols experienced almost the same amount of energy at 0sec initial time, but with different initial energy for sensing the channel. It is clear that the main difference between the protocols, with regards to energy consumption, is the directional properties which are possessed by the proposed model. In Figures 6.6(a)(b), two different power models were tested and this proves the need for selecting the APS model rather than DSPS in the implementation of the proposed model. The APS model performs better than the DSPS model with noticeable differences in-between for both data and VoIP traffic. When the communication process is stabilised at 40sec, it is assumed that the proposed model spent less energy in the idle mode which in turn, saved more energy than the existing model. As the simulation time increases, the difference between the models becomes clearer in terms of energy spent by the models.

It is also assumed that the improvement of the proposed protocol came as a result of using the FHSS system instead of DSSS to transmit power control in the CAP, which results in saving

more energy at the MAC layer and also collaborates with the physical transmission control at the PHY layer. The 2.4 GHz frequency used at the PHY layer operates as an unlicensed system that shared the medium of transmission with other license users within the same band.

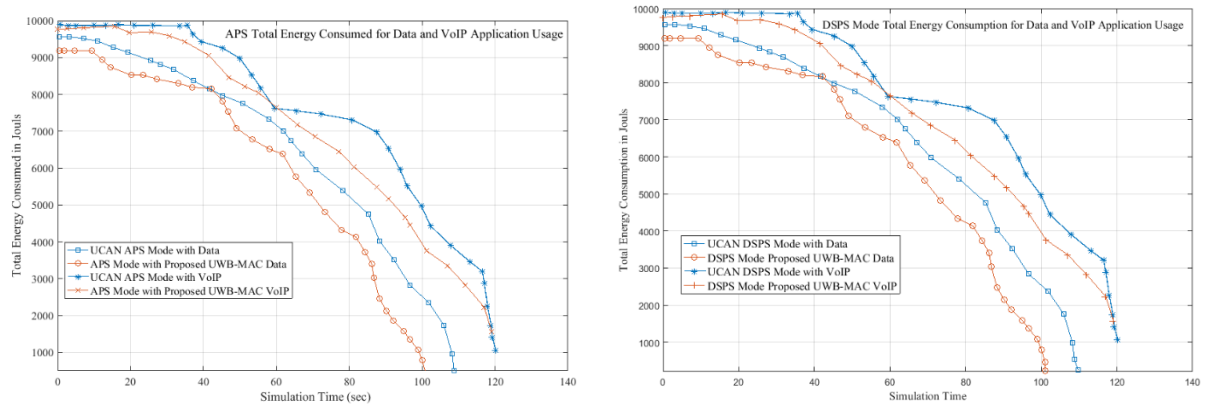

Figure 0.6: (a),(b) Total Energy Consumed in Joules with Data and VoIP using APS and DSPS Mode.

The energy is saved due to overcoming many problems of overlapping and interference in the medium as a result of good operation and negotiation of transmitting power control standards on each node in the network. In the CAP, the transmitted power is adjusted by the use of the CTA mechanism, and support in reducing power usage, as well as overall inference level generated by the piconet. This enhances the proposed protocol to subject the use of less energy for transmission.

Table 0.6: Total Energy Consumption (APS and DSPS mode) for Minimum and Maximum Percentage Difference

Total Energy Consumption with APS Mode				
<i>Model</i>	<i>MinValue</i>	<i>MaxValue</i>	<i>%MinDifference</i>	<i>%MaxDifference</i>
UCAN APS mode Data	231	9559	10%	40%
Proposed APS mode Data	207	9182		
UCAN APS mode with VoIP	1052	9892	33%	10%
Proposed APS mode with VoIP	1562	9848		
Total Energy Consumption with DSPS Mode				
<i>Model</i>	<i>MinValue</i>	<i>MaxValue</i>	<i>%MinDifference</i>	<i>%MaxDifference</i>
UCAN APS mode Data	246	9573	11.5%	45.8%
Proposed APS mode Data	221	9182		
UCAN APS mode with VoIP	1052	9892	39.5%	16.5%
Proposed APS mode with VoIP	1562	9848		

The communication process for the two principles follows the same pattern with regards to energy consumption. The significant difference between the two power management modes is about 5-8%, a great difference. Table 6.6 shows a percentage difference at initial and glazing stage in regards to total energy consumption for the two models. The initial behaviour of both the models when using two different power management modes (APS and DSPS) shows that the proposed model consumes less energy compared to the UCAN approach. For APS mode with data traffic it is 10% and 33% with VoIP traffic and the maximum difference is 40% for data traffic and 10% for VoIP traffic.

There is an increment as the power management mode changes to DSPS for both data and VoIP traffic compared to when using APS mode. APS mode is more reliable in saving energy than DSPS mode.

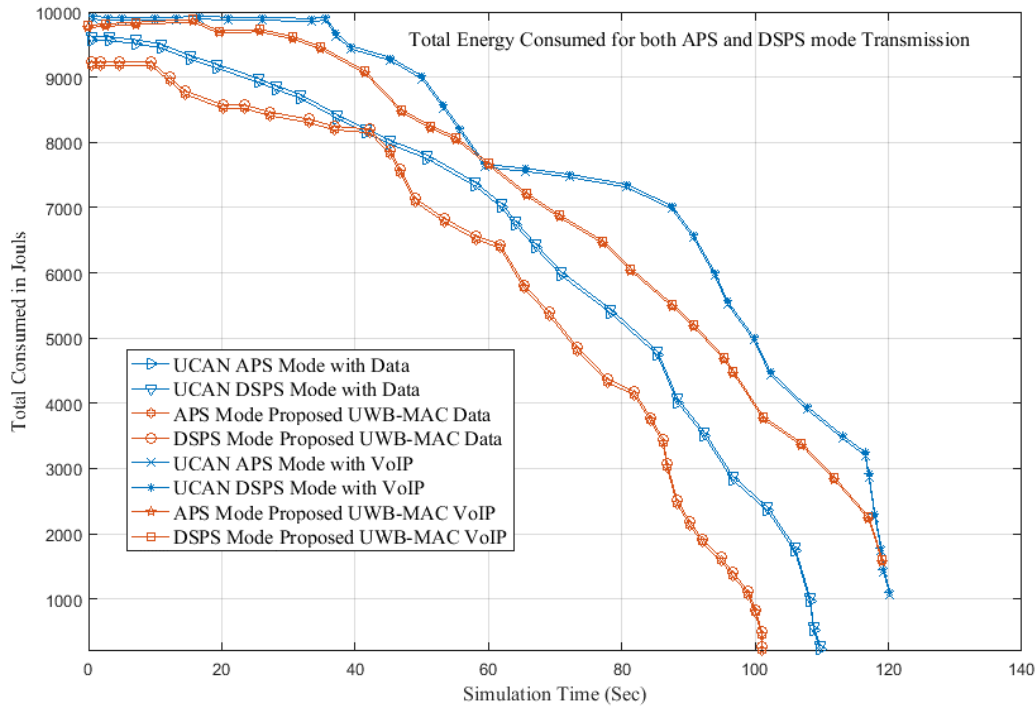

Figure 0.7: Total Energy Consumed in Joules with data and VoIP using APS and DSPTS Mode.

Another assumption for the difference between APS and DSPTS power management modes is that devices in APS mode usually sent at least one acknowledgement frame to the PNC during a communication process to avoid being disassociated from their respective piconet which leads to saving more energy than the devices in DSPTS mode. In contrast to DSPTS mode, two or more ACK frames need to be sent to keep the channel active and this leads to energy surplus. The power conservation in APS mode is achieved by compelling non-active devices to SLEEP instead of remaining AWAKE although, the only disadvantage of using APS mode is that, it cannot be combined with any other power management standards.

6.5 General Discussion of Results

This chapter has discussed important findings made from various simulations conducted to highlight the prospects for the implementation of the new protocol over existing methods. A great challenge in the design and analysis of MANETs is their independence, most importantly, their self-organising nature. Hence, mobility and energy consumption are important

considerations in the design and analysis of ad hoc networks and have been at the centre of countless research studies.

In this research, a number of metrics have been used to determine the superiority of the new protocol over existing systems using numerous scenarios to test various traffic patterns and power management modes such as ASP and DSPS. Scenarios have been built to study the behaviour of the MAC protocols for the existing and proposed systems from start, transmission, reception, idle, sleep and stopping states. A number of metrics used for the evaluation of these systems include saturated performance through collision rate, average channel access delay, packet delivery ratio and the total energy consumption.

In a network, the saturated performance throughput is calculated as the maximum increase in density and is measured under overload conditions like the node transmission queue. By definition, saturated throughput is the limit reached by system throughput as the offered load increases. Hence, the higher the saturated throughput, the better the network, as the network is better able to cope with heavy traffic load. An analysis of saturated throughput comparing the proposed UWB-MAC model with existing models, presented in Figure 6.1, based on node density for CBR and VoIP traffic, have shown how significantly the proposed model outperforms existing protocols in terms of saturated throughput. The proposed model has also outperformed the UCAN approach in terms of saturated throughput. Thus, experimental analysis has provided evidence of the superiority of the proposed model in terms of saturated throughput as compared to the models tested.

The collision rate is also a measure of the resilience of a network. It is characterised by the total number of nodes attempting to transmit data packets at the same time through the same medium. The higher the collision rate, the less resilient the network. This is because the network now has to cope with the issues of packet re-transmission which occur in networks with high

collision rates as the channel disregards data packets and re-transmission occurs, leading to lower quality of service. In the proposed UWB-MAC however, collision is minimised using a backoff algorithm in which a re-transmitting device uses specific random time to sense the idleness of the network before re-transmission. The collision rate of the proposed UWB-MAC has been analysed and compared to that of UCAN-MAC for data and VoIP for 140 seconds simulation time and the results presented in Figure 6.3. This results once again prove the superiority of the proposed model over existing models. In the proposed Directional UWB-MAC, the use of high antenna sector increases the throughput as presented in Figure 6.1 and decreases the collision rate as presented in Figure 6.3.

Average channel access delay is another metric selected for evaluation in this research work. The average channel access delay is the average value of delivered packets recorded during the simulation minus the generated packets recorded for delivery through the channel. An analysis of the average channel access delay for the UWB-MAC with directional antenna as compared to the UCAN with omni and directional antennas is conducted and presented in Figure 6.4. The results of this analysis show that as the network stabilises, both UCAN modes experience longer delays than the UWB-MAC using directional antenna. It is assumed that the main reasons for this achievement are that the directional system uses less time in idle mode after receiving RTS/CTS packets from neighbouring nodes and that the unused sectors of the antennas were blocked for a period of time. Transmission takes place in the active sector, and this normally increases the spatial re-use of the channel which provides better performance in the network. The proposed algorithm also uses directional NAV delta angle to cater for interference due to other frequencies which helps the algorithm in adjusting NAV duration value to yield maximum throughput and to reduce delay in the channel.

The packet delivery ratio is determined by the number of Constant Bit Rate (CBR) streams used in the network. It was measured using data and VoIP from the traffic source and the traffic

sink in the network. The two applications were analysed using omni-directional and directional antenna and the results are presented in Figure 6. On computing the ratio between the number of data packets received by destination nodes and the number of packets transmitted by the source nodes, results indicate that the proposed UWB-MAC outperforms existing models. Table 6.5 is used to present the percentage difference of packet delivery ratio for both data and VoIP traffic at minimum and maximum levels and data from the Table indicates superiority of the proposed model over the UCAN model with respect to packet delivery in the medium.

Total energy consumption for the network is another metric considered for analysis in this research work. Energy consumption is an important parameter in the design of MANET protocols and the aims and contribution of this research work. An efficient ad hoc network transmission needs to provide a good protocol for energy saving within network devices. Hence, the novel protocol is designed such that, in any state energy change, there is a notification state to the energy source to update the current draw from the device. Here too, the operation of the two protocols indicates that the proposed system performs better than the existing MAC for both data and VoIP. Two power models have been tested and the results presented in Table 6.6 which prove the superiority of the APS model over the DSPS in the implementation of the proposed model.

6.6 Chapter Summary

This chapter validates a novel directional UWB-MAC protocol which is designed to overcome high energy consumption in MANETs, which disputes the performance of an existing UCAN MAC protocol standard by utilising the use of a directional antenna system instead of a pure omni-directional antenna. The chapter demonstrates the power of the NS-3 simulator in the implementation of the proposed protocol which other simulators do not have the capacity to

demonstrate. Results of the simulation show that the proposed directional UWB-MAC outperforms the UCAN standard approach with regards to energy consumption, saturated throughput, channel access delay, packet delivery ratio and the collision rate. General observations of results are conducted on the simulated results and comparisons are made with the numerical results obtained in chapter four and preliminary results obtained from literature in chapter three. This summary is an overlay of the next chapter which presents the concluding remarks, recommendations, future work, observations and achievements of the research study.

Chapter Seven

7.0 Summary and Conclusion

This thesis presents a research study with detailed achievements of how the process has been accomplished. The first part gives a detailed overview of the study areas covering the aims, objectives, problems to be solved and a clear hypothesis. It also discusses the details of how the problems have been solved. The second part deals with the background study and highlights some of the basic concepts of the research study. The next chapter deals with the literature review which aids in the understanding of current challenges in the area. The review identified the characteristics and existing challenges of MANETs, focusing on the transmission phase. Furthermore, much about UWB technology has also been reviewed with its applications in MANETs. The review chapter also highlights the advantages of directional antennas and how they can be used to conserve more energy in MANETs through the MAC layer.

From the state of the art review in the related literature, media access control has been indicated as one of the major issues for MANETs and beyond. This is due to the fact that it requires concise planning and an optimisation framework to be made available to heighten the performance of the network. This project, through the literature review, shows the importance of UWB technology and its limitations in relation to these issues. From the reviewed literature, not much research work has been done on the MAC protocol specifically in relation to power consumption. It also reveals that researchers have mostly used assumptions and untested hypotheses in optimizing MANETs in their work. No literature has actually exploited the potential of UWB in the optimization of MANET. Therefore, it becomes important to employ these techniques considering the inherent optimising power (intelligent decision-making) contained in these techniques. For this reason, this research study has taken an entirely different

approach to planning optimization by studying how to develop a collaboration algorithm and by using the UWB technology to solve MANET problems.

In view of the significance of energy conservation in MANETs with regards to energy conservation, the research study presented a design approach for the proposed UWB-MAC using directional antennas and the proposed model constraints. UWB-MAC parameters were established and validated based on a traffic model and schematic approach. An analytical model was defined and established and will be validated via numerical data from the literature. The research study has adopted a reverse engineering approach by using selected techniques in order to compare the result with our simulated results. After reviewing literature, a preliminary simulation is conducted using the QualNet Simulator to test the viability of the research hypothesis. The simulation result shows that the proposed UWB-MAC behaved perfectly compared to the original versions of the MAC protocol. The outcome of the simulated results in section 2.17 shows that the existing MAC protocol, using omni-directional antennas to send RTS/CTS, uses high bandwidth which results in wasting maximum energy by the wireless medium over a large area network. The proposed and adapted schemes use directional antennas which improved bandwidth efficiency and energy is conserved for optimum performance.

In chapter four, a model is designed from the outcome of the reviews conducted and performance analysis is conducted on the impact of using the UWB system with directional antennas focusing on the MAC layer in MANET with respect to different parameters. The designed approach explored the description of functions used and various stages of implementing the PHY-aware MAC protocol which is useful for protocol designers in order to understand more concepts and help to utilise the merits of UWB systems in WSN. The results of the analysis were compared with existing MAC protocols and other directional MAC protocols with respect to important design parameters. The quantitative results demonstrate the power of using directional antennas in MANET over omni-directional antennas. The model

attempts to signify a realistic behaviour of MANETs with respect to energy conservation and the numerical results obtained are realistic when evaluating solutions to MANET that take into account the energy used by the mobile nodes.

In chapter five, the implementation aspect of the proposed power conservation model is an interesting issue which constitutes 40% of the research study. A framework is presented for a proper implementation procedure in section 5.3 and the priority entities considered are the PHY and MAC layer in the communication medium. The PHY layer is implemented through the use of MATLAB Simulink and later on, integrated with the NS-3 simulator. This is considered as a factor in the development of WSN protocols, specifically the PHY and MAC layers of the network. The PHY layer implementation deals with the sensing mechanism, BER, directivity, adaptation and channel coding enhancement and organisation. The MAC layer has three entities but priority one is the optimisation unit that deals with data type, network capacity, distance between nodes, propagation channel, antenna height and direction of transmission and reception. The best advantage of the implementation process is the achievement of low energy consumption and the results obtained after simulation, in terms of the metrics outcome. The MAC layer implementation is purely in NS-3 through the Asynchronous power saving algorithm and schematic state-based energy conservation model.

The enhanced MAC enables the use of directional antenna in IEEE 802.15.3 based on defined parameters as in section 6.3 for MANET based systems. The key contribution is a power efficient transmission protocol that supports multiple access in MANETs using the UWB superframe. The protocol achieved a low energy consumption and transmitted using a high data rate in terms of delivery on the IEEE 802.15.3 with full compatibility of using the UWB system. It is a pure supported directional antenna UWB-MAC which addresses the issue of device discovery which is one of the problems of using directional antennas. The system reduces a

significant number overhead and increases the efficiency of the channel with about 40 – 50% compared to other proposed concepts.

The research aim is accomplished from the results obtained in which the outcome demonstrates an improved designed of UWB-MAC with a minimum energy consumption compared to existing approaches in MANETs. The research study strongly infers that the hypothetical statement in section 1.5 is accepted with excessive percentage based on the outcome of the analysis derived from the simulation. The unique characteristics of the high speed UWB system, with the aid of a directional antenna system, can be used to design and develop a robust MAC protocol which can consume less energy with a minimum of disputes. The energy consumption model developed leads to the performance analysis that produces results, and the results indicate a great performance of the proposed model compared to existing models.

Finally, in chapter six, performance analysis of the network is configured in a simulation testbed, and results for the metrics selected for validating the proposed model are analysed. The performance awareness MACs both for the existing and proposed models were examined thoroughly. Since collision, delay, high energy consumption, interference, rate of packet delivery and saturation level degrades the performance of MANETs, the simulated results show that these effects were clearly overcome by the proposed system with clear differences. The simulation results tally with the numerical analysis in chapter four and the preliminary results in chapter three in terms of lower energy consumption of the proposed directional UWB-MAC, compared to the existing MAC protocol. The power saving feature is a unique aspect of the proposed model, as the system experienced less delay as compared to the UCAN MAC with APS and DSPS mode and consumed less energy. The enhancement of the proposed model, in terms of energy saving, collision reduction and delay, as compared to research work in [100, 101, 113, 114], indicates that the model performs better. However, the simulation testbed, simulation parameters, techniques and frameworks differ. [113] agrees, however, that the use

of spin techniques in implementing their concept is time consuming and requires huge financial support and energy saved by the protocol relying on identifying only deafness in the medium without considering other factors.

7.1 Research Difficulties and Recommendations

Many difficulties were encountered during the research study but some were as follows:

- Learning new simulators that are unfamiliar to the researcher, especially those that do not use a graphical user interface like NS-3 simulators. All the packages used in the implementation process required a full knowledge of programming in one way or the other. As the research study required the use of computer simulators for implementation, selecting and studying network simulators became compulsory and time consuming. When testing the preliminary session of the study, QualNet was used and accessing backend of the application to modify an existing protocol is challenging. Other challenges of using QualNet are its lack of speed, high error rate in compilation and simulation, and it does not support the latest full wideband technologies. Writing code in NS-3 is difficult, especially considering the time factor. Reading thousands of programming lines, tracing modification points, recompiling and dealing with error (syntax or logical) took a long time. Similarly, designing and implementing the PHY layer of the proposed model in Simulink was difficult and time consuming.
- As the stages of the research study progressed, the issue of debugging errors came in and therefore, all stages from the framework had to be checked and tested one after the other. Another issue after forming the scenarios was extracting numerical results and plotting them into graphical formats for analysis. There were difficulties in calculating the total energy consumed, saturated throughput, collision rate and packet delivery ratio.

- Finally, handling time management and procrastination during the research study was the most difficult thing to control.

The greatest recommendation to overcome the difficulties highlighted above, was to give maximum focus to whatever situation the researcher found himself in and to move with the current system by knowing the current trends in the field.

7.2 Research Limitation

MANET is a very wide subject to research because of the existing challenges in the environment. Different issues are, as yet, unresolved, hence our research focus. The research only targeted saving energy in the system specifically at the MAC layer and to achieve the research aim by only using directional antennas. The used IEEE 802.15.3 as our testbed sample because it had the closest features to the UWB system.

7.3 Future Work

The thesis provides an in-depth energy conservation model for enhancing the efficiency of the UWB based MAC protocol in MANET. This was achieved through the use of a steerable directional antenna system to overcome the problems of mobility, hidden terminal and deafness that lead to reduction of delay and collision in the communication environment. In consideration of the proposed concept and with the current advancement in wireless communication, there are various research areas on energy conservation and related concepts that can be used to achieve the same outcome. Contemporary literature mentions several issues, some of which have been addressed in this research study, while the remaining will be part of future research. The following future work is suggested for the optimisation of the simplified energy conservation model as well as improving the quality of service as follows:

- VoIP application is implemented in the study as a heavy application in a generic form without excavating into its real properties. Therefore, testing other parameters that may consume much energy into the proposed model is necessary. Parameters like codec and mean opinion score can be tested to measure performance of the protocol in terms of jitter and other metrics. With this, there is a need to modify the model to the newly adapted UWB-MAC protocol that will pair with difference applications to largely exploit UWB features.
- The implementation and validation of both the PHY and MAC layers of the proposed model are done on a simulator which is centred on low complexity and implementation cost. It is possible to extend it on core hardware and this may require additional expense and complexity.
- To achieve more adaptive UWB-MAC with untainted directional transmission/reception and less energy consumption in the medium, a cross-layer designs approach for MANETs is required for better communication linkage between all the layers in the network.
- Supplementary power management techniques should be investigated with different traffic models in terms of capacity, effect of hardware based on power control, and antenna correlations in mobile devices for better performance.
- In the simulation chapter, the researcher put more emphasis on density and simulation time in the model alone because of the time constraint. Therefore, many scenarios can be created to study the performance of other variables like different angles of transmission/reception and antenna height variation.
- In this study, the priority is on the MAC layer without consideration given to what goes around in the routing scene and the performance of the routing protocol used (TORA). An in-depth study is necessary to explore the fitness of the model at a routing layer.

7.5 Research Accomplishments

The design and implementation of the proposed model of an enhanced energy efficient UWB-MAC using steerable directional antennas in MANETs has achieved the proposed objectives laid out in section 1.3.2. The key design objectives were achieved from extensive reviews, design parameters, implementation, analysis and developing the simulation test bed and validation of the model. The research and development process of the study was implemented using a stage-by-stage process. A literature review was conducted at the beginning that gave the researchers an understanding of clear research gaps and a methodology for implementation. This was followed by an identification of some parameters and the design implementation process. An analysis and validation process was conducted on the proposed model and the PHY layer was implemented in a MATLAB Simulink environment for testing. A framework was designed based on the outcome of the design process to present a fully functioning communication system for proper implementation. Later on, a test bed approach was made using NS-3 simulator to integrate the PHY and MAC layers to obtain results for analysis.

Successful transmission was observed in both the PHY and the MAC layers' implementation process. The successful transmission of the working PHY layer was determined by yielding a low bit error rate and the long-distance coverage by the nodes in the medium. The concept of multi-band orthogonal frequency division multiplexing modulation and conformation of ECMA-368 standard improved the throughput of the communication. The UWB concept of diverse spectrum and spatial dimension used in the design approach increased the robustness of the proposed model. The directional antenna approach in terms of antenna height, antenna efficiency and direction of arrival were considered in the optimisation process.

High data rate was observed with low collision rates, emitting low energy with greater performance. The cost of the implementation process is lower because of the free licence

spectrum that was issued by the FCC. The proposed directional UWB-MAC performs upright and this is the contribution of the research study in terms of power efficiency for a transmission protocol that supports multiple access in MANETs using UWB technology. Another contribution made was that of a low energy consuming protocol that transmits a high data rate and supports directional antennas for MANETs.

7.6 Concluding Remarks

From this research study, a vivid state-of-the-art of MANETs is presented in terms of design and implementation of an energy conservation model using Ultra WideBand systems in conjunction with steerable directional antennas. Numerical values from literature have been used to validate the proposed model against the existing model in terms of energy usage by iterating values of distance, constant bitrate, density, propagation channel and directivity. The results obtained from the analytical model show that the proposed model outperformed the existing system. A framework and schematic power management algorithms were built and implemented to increase the performance of the MAC protocol and this has been made visible through the results obtained. From the results, it can be clearly observed that the performance has been greatly improved in terms of the throughput and packet delivery in the communication medium when compared to other, previous research works. The collision rate in the proposed model was low and the total energy consumed by the model is also low compared to existing models.

The results have been achieved through the development of simulation testbed that integrates the different design stages to form a single system. The proposed model can be integrated in different MANET systems for better performance and at a relatively low cost. The ECMA-368 standard is used for the implementation of the PHY layer and the MIMO channelling is adapted through MB-OFDM techniques. Asynchronous Power Saving and state-based energy

consumption models have been used for the implementation of the proposed model at the MAC layer. Further research work can be undertaken on the proposed model to come up with different frameworks of implementation for future system development.

References

- [1] M. Conti and S. Giordano, "Mobile ad hoc networking: milestones, challenges, and new research directions," (in English), *Communications Magazine, IEEE*, vol. 52, no. 1, pp. 85-96, Jan 2014.
- [2] O. B. Abdulghfoor, M. Ismail, and R. Nordin, "Application of game theory to underlay ad-hoc cognitive radio networks: An overview," in *Space Science and Communication (IconSpace), 2013 IEEE International Conference on*, 2013, pp. 296-301.
- [3] W. Z. Xuemin (Sherman) Shen, Hai Jiang, and Jun Cai, "Medium Access Control in Ultra-Wideband Wireless Networks," *IEEE Transactions On Vehicular Technology*, vol. 54, no. 5, pp. 1663 - 1377, 2005.
- [4] P.-Y. Kong and M. R. Shajan, "A Medium Access Control Protocol For Ultra-Wideband Wireless Ad Hoc Networks," *Vehicular Technology Conference, 2005. VTC 2005-Spring. 2005 IEEE 61st*, vol. 3, pp. 1993 - 1997, 2005.
- [5] A. Idrissi, "How to minimize the energy consumption in mobile ad-hoc networks," *arXiv preprint arXiv:1307.5910*, 2013.
- [6] T. Women, "An analysis of energy models for mobile ad hoc networks," *Journal of Theoretical and Applied Information Technology*, vol. 58, no. 3, 2013.
- [7] S. S. Raghuwanshi and B. Patel, "Identification of energy consumption packets in MANET routing protocols under CBR and exponential traffic models," *IJCSIT) International Journal of Computer Science and Information Technologies*, vol. 3, no. 3, pp. 4171-4175, 2012.
- [8] J. Loo, J. L. Mauri, and J. H. Ortiz, *Mobile ad hoc networks: current status and future trends*. CRC Press, 2016.
- [9] M. S. I. M. Zin and M. Hope, "A Review of UWB MAC Protocols," pp. 526-534, 2010.
- [10] P. Mohapatra and S. Krishnamurthy, *Ad hoc networks: technologies and protocols*. Springer Science & Business Media, 2004.

- [11] P. Ghosekar, G. Katkar, and P. Ghorpade, "Mobile ad hoc networking: imperatives and challenges," *IJCA Special issue on MANETs*, vol. 3, pp. 153-158, 2010.
- [12] J. R. Agre and K. D. Gordon, "A Summary of Recent Federal Government Activities to Promote Spectrum Sharing," ed, 2015.
- [13] T. W. Barrett, "History of ultra wideband communications and radar: Part II, UWB radars and sensors," *Microwave Journal*, vol. 44, no. 2, pp. 22-22, Feb 2001.
- [14] T. W. Barret, "History of ultra wideband communications and radar: Part II, UWB radars and sensors," *Microw. J.*, vol. 44, no. 2, pp. 22-52, 2001.
- [15] A. M. Abbosh, "Design method for ultra-wideband bandpass filter with wide stopband using parallel-coupled microstrip lines," (in English), *IEEE Transactions on Microwave Theory and Techniques*, vol. 60, no. 1, pp. 31-38, Jan 2012.
- [16] A. Lalagüe, "Use of Ground Penetrating Radar for Transportation Infrastructure Maintenance," 2015.
- [17] Q. Rasheda and H. Mohammed, "Ultra wideband antenna for microwave imaging using modified fractal structure," Universiti Tun Hussein Onn Malaysia, 2017.
- [18] A. Lähteenmäki, "A 22 GHz prototype receiver for continuous comparison polarimetry," 2016.
- [19] W. Hirt, "Ultra-wideband radio technology: overview and future research," (in English), *Computer Communications*, vol. 26, no. 1, pp. 46 - 52, Jan 1 2003.
- [20] W. Tang and E. Culurciello, "A Low-Power High-Speed Ultra-Wideband Pulse Radio Transmission System," *IEEE Transactions On Biomedical Circuits And Systems*, vol. 3, no. 5, pp. 286 - 292, Oct 2009.
- [21] M. A. M. Alam, A. Radwan and J. Rodriguez, "Context Based Node Discovery Mechanism For Energy Efficiency In Wireless Networks," (in English), *IEEE ICC 2012 Workshop on Cognitive Radio and Cooperation for Green Networking*, pp. 6008 - 6012, 2012.

- [22] M. H. M. Bocquet, F. Boukour, C. Loyez, C. Lethien, and N. Rolland, "Time Reversal: Impact on the performance of an UWB location system," *IEEE Proceedings of the 2nd European Wireless Technology Conference*, pp. 120 - 123, 2009.
- [23] D. Wu, L. Bao, R. Li, and F. Zeng, "Fast Localization Using Robust UWB Coding in Wireless Sensor Networks," pp. 319-326, 2009.
- [24] J. H., L., Wang, and X., Ai, "A Routing Protocol of MANET Based on UWB," *IEEE* pp. 435 - 439, 2011.
- [25] B. S. G., "Multiple Access and Broadcasting In Self-Organizing Radio Networks With Ultra Wide Band Pulse Signals," *2009 19th Int. Crimean Conference "Microwave & Telecommunication Technology" (CriMiCo'2009). Sevastopol, Crimea, Ukraine*, pp. 263 - 264, 2009.
- [26] S. Ullah *et al.*, "A comprehensive survey of wireless body area networks," *Journal of medical systems*, vol. 36, no. 3, pp. 1065-1094, Jun 2012.
- [27] S. Alikhani, T. Kunz, M. St-Hilaire, and F. R. Yu, "A central-networked cross-layer design framework for wireless sensor networks," in *Proceedings of the 6th international wireless communications and mobile computing conference*, 2010, pp. 301-305: ACM.
- [28] S. Kaur and L. Mahajan, "Power saving MAC protocols for WSNs and optimization of S-MAC protocol," *International Journal of Radio Frequency Identification & Wireless Sensor Networks*, vol. 1, no. 1, pp. 1-8, 2011.
- [29] J. Kabara and M. Calle, "MAC protocols used by wireless sensor networks and a general method of performance evaluation," (in English), *International Journal of Distributed Sensor Networks*, 2012.
- [30] R. Zhang, R. Ruby, J. Pan, L. Cai, and X. Shen, "A hybrid reservation/contention-based MAC for video streaming over wireless networks," (in English), *IEEE Journal on Selected Areas in Communications*, vol. 28, no. 3, pp. 389-398, Apr 2010.
- [31] R. Gillon, G. Gangemi, M. Grosso, F. Fummi, and M. Poncino, "Multi-domain simulation as a foundation for the engineering of smart systems: Challenges and the

- SMAC vision," in *Electronics, Circuits and Systems (ICECS), 2014 21st IEEE International Conference on*, 2014, pp. 858-861: IEEE.
- [32] L. Dunbar, T. B. Mack-Crane, S. Hares, R. Sultan, P. Ashwood-Smith, and G. Yin, "Virtual Layer 2 and mechanism to make it scalable," ed: Google Patents, 2015.
- [33] J. B. Lim, B. Jang, and M. L. Sichitiu, "MCAS-MAC: A multichannel asynchronous scheduled MAC protocol for wireless sensor networks," (in English), *Computer Communications*, vol. 56, pp. 98-107, Feb 1 2015.
- [34] P. K. Batra and K. Kant, "A clustering algorithm with reduced cluster head variations in LEACH protocol," *International Journal of Systems, Control and Communications*, vol. 7, no. 4, pp. 321-336, 2016.
- [35] J. Cecílio and P. Furtado, "Scheduling of Wireless Sensor Networks," in *Wireless Sensors in Industrial Time-Critical Environments*: Springer, 2014, pp. 41-50.
- [36] S. Barua, F. Afroz, S. S. Islam, A. U. Ahmed, P. Ghosal, and K. Sandrasegaran, "Comparative study on priority based QOS aware mac protocols for WSN," *International Journal of Wireless & Mobile Networks*, vol. 6, no. 5, p. 175, 2014.
- [37] M. Khanafer, M. Guennoun, and H. T. Mouftah, "A survey of beacon-enabled IEEE 802.15. 4 MAC protocols in wireless sensor networks," (in English), *IEEE Communications Surveys & Tutorials*, vol. 16, no. 2, pp. 856-876, 2014.
- [38] D. Chen, M. Nixon, S. Han, A. K. Mok, and X. Zhu, "WirelessHART and IEEE 802.15. 4e," in *Industrial technology (icit), 2014 ieee international conference on*, 2014, pp. 760-765: IEEE.
- [39] I. Wadhaj, I. Kristof, I. Romdhani, and A. Al-Dubai, "Performance evaluation of the RPL protocol in fixed and mobile sink low-power and lossy-networks," in *Computer and Information Technology; Ubiquitous Computing and Communications; Dependable, Autonomic and Secure Computing; Pervasive Intelligence and Computing (CIT/IUCC/DASC/PICOM), 2015 IEEE International Conference on*, 2015, pp. 1600-1605: IEEE.

- [40] A. Ali, W. Huiqiang, L. Hongwu, and X. Chen, "A survey of MAC protocols design strategies and techniques in wireless ad hoc networks," *Journal of Communications*, vol. 9, no. 1, pp. 30-38, 2014.
- [41] K. C. Rahman, "A survey on sensor network," *Journal of Computer and Information Technology*, vol. 1, no. 1, pp. 76-87, 2010.
- [42] E. Karapistoli, I. Gragopoulos, I. Tsetsinas, and F.-N. Pavlidou, "A MAC protocol for low-rate UWB wireless sensor networks using directional antennas," (in English), *Computer Networks*, vol. 53, no. 7, pp. 961-972, May 13 2009.
- [43] P. Likhar and R. S. Yadav, "Securing IEEE 802.11 G WLAN Using OpenVPN and Its Impact Analysis," *arXiv preprint arXiv:1201.0428*, 2012.
- [44] U. Lee, I. Rimaç, and V. Hilt, "Greening the internet with content-centric networking," in *Proceedings of the 1st International Conference on Energy-Efficient Computing and Networking*, 2010, pp. 179-182: ACM.
- [45] M. Buettner, G. V. Yee, E. Anderson, and R. Han, "X-MAC: a short preamble MAC protocol for duty-cycled wireless sensor networks," in *Proceedings of the 4th international conference on Embedded networked sensor systems*, 2006, pp. 307-320: ACM.
- [46] R. Kumar and M. K. Rai, "A Survey on MAC Protocols in WSN," *2015 Second International Conference on Advances in Computing and Communication Engineering (ICACCE)*.
- [47] S. S. Compte, J. Lloret, M. G. Pineda, and J. F. T. Alarcón, "Power saving and energy optimization techniques for Wireless Sensor Networks," in *Journal of communications*, 2011, vol. 6, no. 6, pp. 439-459: Engineering and Technology Publishing.
- [48] D. Panasetsky and N. Tomin, "Using of neural network technology and multi-agent systems to preventing large-scale emergencies in electric power systems," in *Energy (IYCE), 2013 4th International Youth Conference on*, 2013, pp. 1-8: IEEE.

- [49] N. K. Ray and A. K. Turuk, "A review on energy efficient MAC protocols for wireless LANs," in *Industrial and Information Systems (ICIIS), 2009 International Conference on*, 2009, pp. 137-142: IEEE.
- [50] S. Muthuramalingam, V. V. Ananth, and M. S. Kumar, "An Energy-Conserving Topology Maintenance Algorithm in Manets," in *Eco-friendly Computing and Communication Systems (ICECCS), 2014 3rd International Conference on*, 2014, pp. 110-115: IEEE.
- [51] A. Meshram and M. Rizvi, "Issues and challenges of Energy consumption in Manet protocols," *International Journal of Networking and Parallel Computing*, vol. 3, no. 1, 2013.
- [52] L. De Nardis, G. Giancola, and M.-G. D. Benedetto, "A position based routing strategy for UWB networks," in *Ultra Wideband Systems and Technologies, 2003 IEEE Conference on*, 2003, pp. 200-204: IEEE.
- [53] L. Michael and R. Kohno, *Ultra Wideband signals and systems in communication engineering*. Wiley, 2007.
- [54] M. Rajni and M. Reena, "Review of MANETS Using Distributed Public-key Cryptography," *arXiv preprint arXiv:1405.0100*, 2014.
- [55] A. Raverkar, "Route Discovery in Insecure Mobile Ad hoc Network," *Electronics Computer Technology (ICECT), 2011 3rd International Conference* vol. 4, pp. 340-342, 2011.
- [56] P. Bakalis, L. Bello, P. Rapajic, and K. A. Anang, "Power Consumption Analysis in Mobile Ad Hoc Networks," (in English), *Uksim-AmsS Seventh European Modelling Symposium on Computer Modelling and Simulation (Ems 2013)*, pp. 527-532, 2013.
- [57] M. Liu, N. Patwari, and A. Terzis, "Special issue on sensor network applications [Scanning the Issue]," *Proceedings of the IEEE*, vol. 98, no. 11, pp. 1804-1807, 2010.
- [58] V. Potdar, A. Sharif, and E. Chang, "Wireless Sensor Networks: A Survey," in *Advanced Information Networking and Applications Workshops, 2009. WAINA '09. International Conference on*, 2009, pp. 636-641.

- [59] S. Djahel, F. Nait-abdesselam, and Z. Zonghua, "Mitigating Packet Dropping Problem in Mobile Ad Hoc Networks: Proposals and Challenges," (in English), *Communications Surveys & Tutorials, IEEE*, vol. 13, no. 4, pp. 658-672, 2011.
- [60] S. Nagaprasad, V. Mallaiiah, B. Sujatha, A. Vinayababu, K. Madhukar, and A. Srilatha, "Low bandwidth and computational capacity of the nodes in quality of service," in *Electronics Computer Technology (ICECT), 2011 3rd International Conference on*, 2011, vol. 5, pp. 315-319.
- [61] H. Zhonglin and H. Yuhua, "Study on key technologies of MANET," in *Information Science and Management Engineering (ISME), 2010 International Conference of*, 2010, vol. 1, pp. 112-115: IEEE.
- [62] B. Sun, L. Osborne, Y. Xiao, and S. Guizani, "Intrusion detection techniques in mobile ad hoc and wireless sensor networks," (in English), *Wireless Communications, IEEE*, vol. 14, no. 5, pp. 56-63, Oct 2007.
- [63] G. Mamatha and D. S. Sharma, "Analyzing the Manet Variations, Challenges, Capacity and Protocol Issues," *International Journal of Computer Science & Engineering Survey (IJCSSES) Vol*, vol. 1, pp. 14-21 August, 2010.
- [64] K. Taneja and R. Patel, "An Overview of Mobile Ad hoc Networks: Challenges and Future," in *Proceedings of National Conference on Challenges & Opportunities in Information Technology (COIT 2007). RIMT-IET, Mandi Gobindgarh (March 23, 2007)*, 2007.
- [65] J. A. Freebersyser and B. Leiner, "A DoD perspective on mobile ad hoc networks," in *Ad hoc networking*, 2001, pp. 29-51: Addison-Wesley Longman Publishing Co., Inc.
- [66] Z. Niu, "Broadband Computer Networks," *Lecture Notes by Prof. Zhisheng Niu, Tsinghua University*, 2003.
- [67] H. Memarzadeh, M. Dehghan, and S. Jabbehdari, "A New Quorum-Based Power Saving Protocol to Maintain QoS for MANETs with Burst Traffics," pp. 674-679, 2010.

- [68] D. Remondo and I. G. Niemegeers, "Ad hoc networking in future wireless communications," (in English), *Original Research Article Computer Communications*, vol. 26, no. 1, pp. 36 - 40 Jan 1 2003.
- [69] A. F. Molisch, "Ultrawideband propagation channels and their impact on system design," *Invited plenary talk for the IEEE 2007 International Symposium on Microwave, Antenna, Propagation, and EMC Technologies for Wireless Communications (MAPE 2007)*
- [70] A. R. Muhammad Alami, and Jonathan Rodriguez, "On the Significance of Context Information in Node Discovery," *IEEE 17th International Workshop on Computer Aided Modeling and Design of Communication Links and Networks*, 2012.
- [71] H. Arslan, Z. N. Chen, and M.-G. Di Benedetto, *Ultra wideband wireless communication*. John Wiley & Sons, 2006.
- [72] U. P. Daniel, M. Muhammad, and N. C. Agbanusi, "Optimising VoIP Traffic over MANET: Leveraging the Power of TORA On-Demand Routing Protocol," *International Journal of Computer Applications (0975 – 8887)*, vol. 82, pp. 37 - 51, 2013.
- [73] K. Peng-Yong and M. R. Shajan, "A medium access control protocol for ultra-wideband wireless ad hoc networks," in *Vehicular Technology Conference, 2005. VTC 2005-Spring. 2005 IEEE 61st*, 2005, vol. 3, pp. 1993-1997 Vol. 3.
- [74] F. De Rango, P. Fazio, F. Veltri, and S. Marano, "Impact of interference aware metrics over UWB based MANET," in *Wireless Telecommunications Symposium, 2008. WTS 2008*, 2008, pp. 298-303.
- [75] A. Abdrabou and W. Zhuang, "A Position-Based QoS Routing Scheme for UWB Mobile Ad Hoc Networks," (in English), *IEEE Journal On Selected Areas In Communications*, vol. 24, no. 4, pp. 850 - 856, Apr 2006.
- [76] N. Suljanovic, A. Gogic, A. Mujcic, and I. H. Cavdar, "The role of MAC routing in wireless sensor networks," in *Signal Processing and Communications Applications Conference (SIU), 2014 22nd*, 2014, pp. 2323-2326.

- [77] V. A. Charu, "A Quality of Service Analysis of Energy Aware Routing Protocols in Mobile Ad Hoc Networks," (in English), *IEEE Contemporary Computing (IC3), 2013 Sixth International Conference*, pp. 439 - 444 2013.
- [78] P. Park, C. Fischione, and K. H. Johansson, "Adaptive IEEE 802.15. 4 medium access control protocol for control and monitoring applications," in *Wireless Networking Based Control*: Springer, 2011, pp. 271-300.
- [79] Y. Chu and A. Ganz, "Adaptive MAC protocol for QoS support in UWB-based wireless networks," in *Communications, 2006. ICC'06. IEEE International Conference on*, 2006, vol. 9, pp. 4040-4045: IEEE.
- [80] F. Cuomo, C. Martello, A. Baiocchi, and F. Capriotti, "Radio resource sharing for ad hoc networking with UWB," (in English), *Selected Areas in Communications, IEEE Journal on*, vol. 20, no. 9, pp. 1722-1732, Dec 2002.
- [81] K. Lu, D. Wu, Y. Fang, and R. C. Qiu, "Performance analysis of a burst-frame-based MAC protocol for ultra-wideband ad hoc networks," in *Communications, 2005. ICC 2005. 2005 IEEE International Conference on*, 2005, vol. 5, pp. 2937-2941: IEEE.
- [82] A. Abdrabou and W. Zhuang, "A position-based QoS routing scheme for UWB mobile ad hoc networks," (in English), *Selected Areas in Communications, IEEE Journal on*, vol. 24, no. 4, pp. 850-856, Apr 2006.
- [83] P. Mugen, W. Yingjie, and W. Wenbo, "Investigation of Architecture and Essential Technologies of Wireless Sensor Network."
- [84] R. H. Hwang, C. Y. Wang, C. J. Wu, and G. N. Chen, "A novel efficient power - saving MAC protocol for multi - hop MANETs," *International Journal of Communication Systems*, vol. 26, no. 1, pp. 34-55, 2013.
- [85] D. Sharma and A. Kush, "Power Aware Protocol for Ad-Hoc Network," 2011.
- [86] Y. Park, H. Leem, and D. K. Sung, "Power saving mechanism in IEEE 802.16 m," in *Vehicular Technology Conference (VTC 2010-Spring), 2010 IEEE 71st*, 2010, pp. 1-5: IEEE.

- [87] N. K. Ray and A. K. Turuk, "Energy Efficient Techniques for Wireless Ad Hoc Network," 2010.
- [88] S. M. George *et al.*, "DistressNet: a wireless ad hoc and sensor network architecture for situation management in disaster response," (in English), *Communications Magazine, IEEE*, vol. 48, no. 3, pp. 128-136, Mar 2010.
- [89] V. K. Sharma and D. S. S. Bhadauria, "Congestion and power control technique based on mobile agent and effect of varying rates in MANET," *International Journal of Advancements in Computer Science and Information Technology [2250–2440] Vol*, vol. 1, 2011.
- [90] F. Qin, "QoS Topology Control with Energy Efficiency for MANET," *Journal of Convergence Information Technology*, vol. 6, no. 6, pp. 300-307, 2011.
- [91] Q. Guan, F. R. Yu, S. Jiang, and G. Wei, "Prediction-based topology control and routing in cognitive radio mobile ad hoc networks," (in English), *Vehicular Technology, IEEE Transactions on*, vol. 59, no. 9, pp. 4443-4452, Nov 2010.
- [92] H. Safa and O. Mirza, "A load balancing energy efficient clustering algorithm for MANETs," (in English), *International journal of communication systems*, vol. 23, no. 4, pp. 463-483, Apr 2010.
- [93] A. Sadri, "IEEE802. 15.3 c Usage Model Document," *IEEE802*, pp. 15-06.
- [94] T. H. Sulaiman, K. Sivarajah, and H. S. Al-Raweshidy, "Improved PNC Selection Criteria and Process for IEEE802. 15.3 [Ad Hoc and Sensor Networks]," *IEEE Communications Magazine*, vol. 45, no. 12, pp. 102-109, 2007.
- [95] Y. Zhou, D. I. Laurenson, and S. McLaughlin, "A Novel Piconet Coordinator Selection Method for IEEE802. 15.3-Based WPAN," in *International Workshop on Wireless Ad Hoc Networks, IWWAN*, 2005.
- [96] B. Karaoglu and W. Heinzelman, "A dynamic channel allocation scheme using spectrum sensing for mobile ad hoc networks," in *Global Communications Conference (GLOBECOM), 2012 IEEE*, 2012, pp. 397-402: IEEE.

- [97] A. Gupta and P. Mohapatra, "A survey on ultra wide band medium access control schemes," (in English), *Computer Networks*, vol. 51, no. 11, pp. 2976-2993, Aug 8 2007.
- [98] J.-Y. Le Boudec, R. Merz, B. Radunovic, and J. Widmer, "A MAC protocol for UWB very low power mobile ad-hoc networks based on dynamic channel coding with interference mitigation," 2004.
- [99] T. Spyropoulos and C. S. Raghavendra, "Analyzing the Effect of Antenna Type and MAC Protocol on Wireless Ad-Hoc Network Capacity," USC Technical Report 2006.
- [100] Y.-B. Ko, V. Shankarkumar, and N. H. Vaidya, "Medium access control protocols using directional antennas in ad hoc networks," in *INFOCOM 2000. Nineteenth Annual Joint Conference of the IEEE Computer and Communications Societies. Proceedings. IEEE*, 2000, vol. 1, pp. 13-21: IEEE.
- [101] R. Bhusal, S. K. Timalsina, and S. Moh, "Impact of directional antennas on contention based MAC protocols in ad hoc networks," in *Computing and Networking Technology (ICCNT), 2012 8th International Conference on*, 2012, pp. 405-408: IEEE.
- [102] A. M. Ajofoyinbo and W. W. Li, "Directional antennas MAC protocol for energy - efficient wireless sensor networks with mobile sink," *International Journal of Communication Systems*, 2015.
- [103] N. Rinaldi *et al.*, "UCAN's ultra wide band system: Baseband algorithm design," in *Proc. International Workshop on Ultra Wideband Systems (IWUWBS'03)*, 2003.
- [104] E. Karapistoli, D. G. Stratogiannis, G. Tsiropoulos, and F. Pavlidou, "MAC protocols for ultra-wideband ad hoc and sensor networking: A survey," in *Ultra Modern Telecommunications and Control Systems and Workshops (ICUMT), 2012 4th International Congress on*, 2012, pp. 834-841: IEEE.
- [105] M. Zin, M. S. Izuan, A. Awang Md Isa, M. Isa, and M. Sa'ari, "UWB MAC Design Constraints and Considerations," *International Journal of Computer Science and Mobile Computing*, vol. 2, no. 12, pp. 322-331, 2013.

- [106] E. Karapistoli, I. Gragopoulos, I. Tsetsinas, and F.-N. Pavlidou, "A directional MAC protocol with deafness avoidance for UWB wireless sensor networks," in *Communications, 2009. ICC'09. IEEE International Conference on*, 2009, pp. 1-5: IEEE.
- [107] F. Gao *et al.*, "Broadband dual-polarized omni-directional antenna and feeding method using the same," ed: Google Patents, 2015.
- [108] P. Khan, N. Ullah, S. Ullah, and K. S. Kwak, "Analytical modeling of IEEE 802.15.6 CSMA/CA protocol under different access periods," in *Communications and Information Technologies (ISCIT), 2014 14th International Symposium on*, 2014, pp. 151-155: IEEE.
- [109] B. Clerckx and C. Oestges, *MIMO wireless networks: Channels, techniques and standards for multi-antenna, multi-user and multi-cell systems*. Academic Press, 2013.
- [110] C. A. Balanis, *Antenna theory: analysis and design*. John Wiley & Sons, 2016.
- [111] A. B. Constantine, "Antenna theory: analysis and design," *MICROSTRIP ANTENNAS, third edition, John wiley & sons*, 2005.
- [112] G. Lawyer, "Understanding the influence of all nodes in a network," (in English), *Scientific reports*, vol. 5, p. 8665, Mar 2 2015.
- [113] A. A. Abdullah, L. Cai, and F. Gebali, "DSDMAC: dual sensing directional MAC protocol for ad hoc networks with directional antennas," (in English), *IEEE Transactions on Vehicular Technology*, vol. 61, no. 3, pp. 1266-1275, Mar 2012.
- [114] N. Kumar and S. GNANA DHAS, "An analysis of energy models for mobile ad hoc networks," *Journal of Theoretical & Applied Information Technology*, vol. 58, no. 3, 2013.
- [115] L. Wang, A. Ukhanova, and E. Belyaev, "Power consumption analysis of constant bit rate data transmission over 3G mobile wireless networks," in *ITS Telecommunications (ITST), 2011 11th International Conference on*, 2011, pp. 217-223: IEEE.

- [116] N. Adam, M. Ismail, and J. Abdullah, "Effect of node density on performances of three MANET routing protocols," in *Electronic Devices, Systems and Applications (ICEDSA), 2010 Intl Conf on*, 2010, pp. 321-325: IEEE.
- [117] C. Newport, D. Kotz, Y. Yuan, R. S. Gray, J. Liu, and C. Elliott, "Experimental evaluation of wireless simulation assumptions," *Simulation*, vol. 83, no. 9, pp. 643-661, 2007.
- [118] C. H. Foh and B. S. Lee, "A closed form network connectivity formula one-dimensional MANETs," in *Communications, 2004 IEEE International Conference on*, 2004, vol. 6, pp. 3739-3742: IEEE.
- [119] A. Safaai-Jazi, S. M. Riad, A. Muqaibel, and A. Bayram, "Ultra-wideband propagation measurements and channel modeling," *Report on Through-the-Wall Propagation and Material Characterization*, 2002.
- [120] N. Patwari, "ECE 5325/6325: Wireless Communication Systems Lecture Notes, Fall 2011."
- [121] "Antenna Efficiency: <http://www.antenna-theory.com/basics/efficiency.php>," *Antenna Fundamentals*, 23/01/2017 2016.
- [122] V. Kolar, "Challenges in directional antennas," State University of New York at Binghamton, Computer Science Department, 2004.

Appendices

Appendix A

Numerical Evaluation of Existing and Proposed Model

Existing Model

$$P_{Total} = CR \left(\sqrt{\frac{\lambda^2 P_t G_t G_r}{(4\pi)^2 P_{r,min}}} \right)^\alpha T_{XA}$$

Proposed Model

$$P_{Total} = CR \left(\sqrt{\frac{\lambda^2 P_t G_t G_r}{(4\pi)^2 P_{r,min}}} \right)^\alpha * \frac{2\pi}{\epsilon_R D - KH}$$

i. Change in power with respect to Antenna High (H)

P	C	R	d^α(2^3)	Tx(Degree)	P Total			P	C	R	d^α(2^3)	2π	εR(50% = 0.5 = -3DB)	D (Directivity = 22degrees)	εRD	KH(K=1 and H= 9.6m)	(εRD - KH)	2π/(εRD - KH)	P Total
P0	1000	10	8	360	2.88E+07			P0	1000	10	8	360	0.5	22	11	4.8	6.2	58.064516	4.65E+06
P1	1000	20	8	360	5.76E+07			P1	1000	20	8	360	0.5	22	11	4.8	6.2	58.064516	9.29E+06
P2	1000	30	8	360	8.64E+07			P2	1000	30	8	360	0.5	22	11	4.8	6.2	58.064516	1.39E+07
P3	1000	40	8	360	1.15E+08			P3	1000	40	8	360	0.5	22	11	4.8	6.2	58.064516	1.86E+07
P4	1000	50	8	360	1.44E+08			P4	1000	50	8	360	0.5	22	11	4.8	6.2	58.064516	2.32E+07
P5	1000	60	8	360	1.73E+08			P5	1000	60	8	360	0.5	22	11	4.8	6.2	58.064516	2.79E+07

P	C	R	$d^{\wedge}a(2^{\wedge}3)$	Tx(Degree)	P Total			P	C	R	$d^{\wedge}a(2^{\wedge}3)$	2π	$\epsilon R(50\% = 0.5 = -3DB)$	D (Directivity = 22degrees)	ϵRD	KH(K=1 and H= 9.6m)	($\epsilon RD - KH$)	$2\pi/(\epsilon RD - KH)$	P Total
P0	1000	10	8	360	2.88E+07			P0	1000	10	8	360	0.5	22	11	5.8	5.2	69.230769	5.54E+06
P1	1000	20	8	360	5.76E+07			P1	1000	20	8	360	0.5	22	11	5.8	5.2	69.230769	1.11E+07
P2	1000	30	8	360	8.64E+07			P2	1000	30	8	360	0.5	22	11	5.8	5.2	69.230769	1.66E+07
P3	1000	40	8	360	1.15E+08			P3	1000	40	8	360	0.5	22	11	5.8	5.2	69.230769	2.22E+07
P4	1000	50	8	360	1.44E+08			P4	1000	50	8	360	0.5	22	11	5.8	5.2	69.230769	2.77E+07
P5	1000	60	8	360	1.73E+08			P5	1000	60	8	360	0.5	22	11	5.8	5.2	69.230769	3.32E+07

P	C	R	$d^{\wedge}a(2^{\wedge}3)$	Tx(Degree)	P Total			P	C	R	$d^{\wedge}a(2^{\wedge}3)$	2π	$\epsilon R(50\% = 0.5 = -3DB)$	D (Directivity = 22degrees)	ϵRD	KH(K=1 and H= 9.6m)	($\epsilon RD - KH$)	$2\pi/(\epsilon RD - KH)$	P Total
P0	1000	10	8	360	2.88E+07			P0	1000	10	8	360	0.5	22	11	6.8	4.2	85.714286	6.86E+06
P1	1000	20	8	360	5.76E+07			P1	1000	20	8	360	0.5	22	11	6.8	4.2	85.714286	1.37E+07
P2	1000	30	8	360	8.64E+07			P2	1000	30	8	360	0.5	22	11	6.8	4.2	85.714286	2.06E+07
P3	1000	40	8	360	1.15E+08			P3	1000	40	8	360	0.5	22	11	6.8	4.2	85.714286	2.74E+07
P4	1000	50	8	360	1.44E+08			P4	1000	50	8	360	0.5	22	11	6.8	4.2	85.714286	3.43E+07
P5	1000	60	8	360	1.73E+08			P5	1000	60	8	360	0.5	22	11	6.8	4.2	85.714286	4.11E+07

P	C	R	$d^{\wedge}a(2^{\wedge}3)$	Tx(Degree)	P Total			P	C	R	$d^{\wedge}a(2^{\wedge}3)$	2π	$\epsilon R(50\% = 0.5 = -3DB)$	D (Directivity = 22degrees)	ϵRD	KH(K=1 and H= 9.6m)	($\epsilon RD - KH$)	$2\pi/(\epsilon RD - KH)$	P Total
P0	1000	10	8	360	2.88E+07			P0	1000	10	8	360	0.5	22	11	7.8	3.2	112.5	9.00E+06
P1	1000	20	8	360	5.76E+07			P1	1000	20	8	360	0.5	22	11	7.8	3.2	112.5	1.80E+07
P2	1000	30	8	360	8.64E+07			P2	1000	30	8	360	0.5	22	11	7.8	3.2	112.5	2.70E+07
P3	1000	40	8	360	1.15E+08			P3	1000	40	8	360	0.5	22	11	7.8	3.2	112.5	3.60E+07
P4	1000	50	8	360	1.44E+08			P4	1000	50	8	360	0.5	22	11	7.8	3.2	112.5	4.50E+07
P5	1000	60	8	360	1.73E+08			P5	1000	60	8	360	0.5	22	11	7.8	3.2	112.5	5.40E+07

P	C	R	$d^{\wedge}a(2^{\wedge}3)$	Tx(Degree)	P Total			P	C	R	$d^{\wedge}a(2^{\wedge}3)$	2π	$\epsilon R(50\% = 0.5 = -3DB)$	D (Directivity = 22degrees)	ϵRD	KH(K=1 and H= 9.6m)	($\epsilon RD - KH$)	$2\pi/(\epsilon RD - KH)$	P Total
P0	1000	10	8	360	2.88E+07			P0	1000	10	8	360	0.5	22	11	8.8	2.2	163.63636	1.31E+07
P1	1000	20	8	360	5.76E+07			P1	1000	20	8	360	0.5	22	11	8.8	2.2	163.63636	2.62E+07
P2	1000	30	8	360	8.64E+07			P2	1000	30	8	360	0.5	22	11	8.8	2.2	163.63636	3.93E+07
P3	1000	40	8	360	1.15E+08			P3	1000	40	8	360	0.5	22	11	8.8	2.2	163.63636	5.24E+07
P4	1000	50	8	360	1.44E+08			P4	1000	50	8	360	0.5	22	11	8.8	2.2	163.63636	6.55E+07
P5	1000	60	8	360	1.73E+08			P5	1000	60	8	360	0.5	22	11	8.8	2.2	163.63636	7.85E+07

ii. Change in power with respect to Directivity (D)

P	C	R	$d^{\wedge}a(2^{\wedge}3)$	Tx(Degree)	P Total		P	C	R	$d^{\wedge}a(2^{\wedge}3)$	2π	$\epsilon R(50\% = 0.5 = -3DB)$	D (Directivity = 22degrees)	ϵRD	KH(K=1 and H= 9.6m)	($\epsilon RD - KH$)	$2\pi/(\epsilon RD - KH)$	P Total
P0	1000	10	8	360	2.88E+07		P0	1000	10	8	360	0.5	22	11	9.6	1.4	257.14286	2.06E+07
P1	1000	20	8	360	5.76E+07		P1	1000	20	8	360	0.5	22	11	9.6	1.4	257.14286	4.11E+07
P2	1000	30	8	360	8.64E+07		P2	1000	30	8	360	0.5	22	11	9.6	1.4	257.14286	6.17E+07
P3	1000	40	8	360	1.15E+08		P3	1000	40	8	360	0.5	22	11	9.6	1.4	257.14286	8.23E+07
P4	1000	50	8	360	1.44E+08		P4	1000	50	8	360	0.5	22	11	9.6	1.4	257.14286	1.03E+08
P5	1000	60	8	360	1.73E+08		P5	1000	60	8	360	0.5	22	11	9.6	1.4	257.14286	1.23E+08

P	C	R	$d^{\wedge}a(2^{\wedge}3)$	Tx(Degree)	P Total		P	C	R	$d^{\wedge}a(2^{\wedge}3)$	2π	$\epsilon R(50\% = 0.5 = -3DB)$	D (Directivity = 22degrees)	ϵRD	KH(K=1 and H= 9.6m)	($\epsilon RD - KH$)	$2\pi/(\epsilon RD - KH)$	P Total
P0	1000	10	8	360	2.88E+07		P0	1000	10	8	360	0.5	32	16	9.6	6.4	56.25	4.50E+06
P1	1000	20	8	360	5.76E+07		P1	1000	20	8	360	0.5	32	16	9.6	6.4	56.25	9.00E+06
P2	1000	30	8	360	8.64E+07		P2	1000	30	8	360	0.5	32	16	9.6	6.4	56.25	1.35E+07
P3	1000	40	8	360	1.15E+08		P3	1000	40	8	360	0.5	32	16	9.6	6.4	56.25	1.80E+07
P4	1000	50	8	360	1.44E+08		P4	1000	50	8	360	0.5	32	16	9.6	6.4	56.25	2.25E+07
P5	1000	60	8	360	1.73E+08		P5	1000	60	8	360	0.5	32	16	9.6	6.4	56.25	2.70E+07

P	C	R	$d^{\wedge}a(2^{\wedge}3)$	Tx(Degree)	P Total		P	C	R	$d^{\wedge}a(2^{\wedge}3)$	2π	$\epsilon R(50\% = 0.5 = -3DB)$	D (Directivity = 22degrees)	ϵRD	KH(K=1 and H= 9.6m)	($\epsilon RD - KH$)	$2\pi/(\epsilon RD - KH)$	P Total
P0	1000	10	8	360	2.88E+07		P0	1000	10	8	360	0.5	42	21	9.6	11.4	31.578947	2.53E+06
P1	1000	20	8	360	5.76E+07		P1	1000	20	8	360	0.5	42	21	9.6	11.4	31.578947	5.05E+06
P2	1000	30	8	360	8.64E+07		P2	1000	30	8	360	0.5	42	21	9.6	11.4	31.578947	7.58E+06
P3	1000	40	8	360	1.15E+08		P3	1000	40	8	360	0.5	42	21	9.6	11.4	31.578947	1.01E+07
P4	1000	50	8	360	1.44E+08		P4	1000	50	8	360	0.5	42	21	9.6	11.4	31.578947	1.26E+07
P5	1000	60	8	360	1.73E+08		P5	1000	60	8	360	0.5	42	21	9.6	11.4	31.578947	1.52E+07

P	C	R	$d^{\wedge}a(2^{\wedge}3)$	Tx(Degree)	P Total		P	C	R	$d^{\wedge}a(2^{\wedge}3)$	2π	$\epsilon R(50\% = 0.5 = -3DB)$	D (Directivity = 22degrees)	ϵRD	KH(K=1 and H= 9.6m)	($\epsilon RD - KH$)	$2\pi/(\epsilon RD - KH)$	P Total
P0	1000	10	8	360	2.88E+07		P0	1000	10	8	360	0.5	52	26	9.6	16.4	21.95122	1.76E+06
P1	1000	20	8	360	5.76E+07		P1	1000	20	8	360	0.5	52	26	9.6	16.4	21.95122	3.51E+06
P2	1000	30	8	360	8.64E+07		P2	1000	30	8	360	0.5	52	26	9.6	16.4	21.95122	5.27E+06
P3	1000	40	8	360	1.15E+08		P3	1000	40	8	360	0.5	52	26	9.6	16.4	21.95122	7.02E+06
P4	1000	50	8	360	1.44E+08		P4	1000	50	8	360	0.5	52	26	9.6	16.4	21.95122	8.78E+06
P5	1000	60	8	360	1.73E+08		P5	1000	60	8	360	0.5	52	26	9.6	16.4	21.95122	1.05E+07

P	C	R	$d^{\wedge}a(2^{\wedge}3)$	Tx(Degree)	P Total		P	C	R	$d^{\wedge}a(2^{\wedge}3)$	2π	$\epsilon R(50\% = 0.5 = -3DB)$	D (Directivity = 22degrees)	ϵRD	KH(K=1 and H= 9.6m)	($\epsilon RD - KH$)	$2\pi/(\epsilon RD - KH)$	P Total
P0	1000	10	8	360	2.88E+07		P0	1000	10	8	360	0.5	62	31	9.6	21.4	16.82243	1.35E+06
P1	1000	20	8	360	5.76E+07		P1	1000	20	8	360	0.5	62	31	9.6	21.4	16.82243	2.69E+06
P2	1000	30	8	360	8.64E+07		P2	1000	30	8	360	0.5	62	31	9.6	21.4	16.82243	4.04E+06
P3	1000	40	8	360	1.15E+08		P3	1000	40	8	360	0.5	62	31	9.6	21.4	16.82243	5.38E+06
P4	1000	50	8	360	1.44E+08		P4	1000	50	8	360	0.5	62	31	9.6	21.4	16.82243	6.73E+06
P5	1000	60	8	360	1.73E+08		P5	1000	60	8	360	0.5	62	31	9.6	21.4	16.82243	8.07E+06

P	C	R	$d^{\wedge}a(2^{\wedge}3)$	Tx(Degree)	P Total		P	C	R	$d^{\wedge}a(2^{\wedge}3)$	2π	$\epsilon R(50\% = 0.5 = -3DB)$	D (Directivity = 22degrees)	ϵRD	KH(K=1 and H= 9.6m)	($\epsilon RD - KH$)	$2\pi/(\epsilon RD - KH)$	P Total
P0	1000	10	8	360	2.88E+07		P0	1000	10	8	360	0.5	72	36	9.6	26.4	13.636364	1.09E+06
P1	1000	20	8	360	5.76E+07		P1	1000	20	8	360	0.5	72	36	9.6	26.4	13.636364	2.18E+06
P2	1000	30	8	360	8.64E+07		P2	1000	30	8	360	0.5	72	36	9.6	26.4	13.636364	3.27E+06
P3	1000	40	8	360	1.15E+08		P3	1000	40	8	360	0.5	72	36	9.6	26.4	13.636364	4.36E+06
P4	1000	50	8	360	1.44E+08		P4	1000	50	8	360	0.5	72	36	9.6	26.4	13.636364	5.45E+06
P5	1000	60	8	360	1.73E+08		P5	1000	60	8	360	0.5	72	36	9.6	26.4	13.636364	6.55E+06

iii. Change in power with respect to propagation channel (α)

P	C	R	$d^{\alpha}(2^{2})$	Tx(Degree)	P Total			P	C	R	$d^{\alpha}(2^{2})$	2π	$\epsilon R(50\% = 0.5 = -3DB)$	D (Directivity = 22degrees)	ϵRD	KH(K=1 and H= 9.6m)	($\epsilon RD - KH$)	$2\pi/(\epsilon RD - KH)$	P Total
P0	1000	10	4	360	1.44E+07			P0	1000	10	4	360	0.5	22	11	9.6	1.4	257.1428571	1.03E+07
P1	1000	20	4	360	2.88E+07			P1	1000	20	4	360	0.5	22	11	9.6	1.4	257.1428571	2.06E+07
P2	1000	30	4	360	4.32E+07			P2	1000	30	4	360	0.5	22	11	9.6	1.4	257.1428571	3.09E+07
P3	1000	40	4	360	5.76E+07			P3	1000	40	4	360	0.5	22	11	9.6	1.4	257.1428571	4.11E+07
P4	1000	50	4	360	7.20E+07			P4	1000	50	4	360	0.5	22	11	9.6	1.4	257.1428571	5.14E+07
P5	1000	60	4	360	8.64E+07			P5	1000	60	4	360	0.5	22	11	9.6	1.4	257.1428571	6.17E+07

P	C	R	$d^{\alpha}(2^{2.5})$	Tx(Degree)	P Total			P	C	R	$d^{\alpha}(2^{2.5})$	2π	$\epsilon R(50\% = 0.5 = -3DB)$	D (Directivity = 22degrees)	ϵRD	KH(K=1 and H= 9.6m)	($\epsilon RD - KH$)	$2\pi/(\epsilon RD - KH)$	P Total
P0	1000	10	5.656854249	360	2.04E+07			P0	1000	10	5.656854249	360	0.5	22	11	9.6	1.4	257.1428571	1.45E+07
P1	1000	20	5.656854249	360	4.07E+07			P1	1000	20	5.656854249	360	0.5	22	11	9.6	1.4	257.1428571	2.91E+07
P2	1000	30	5.656854249	360	6.11E+07			P2	1000	30	5.656854249	360	0.5	22	11	9.6	1.4	257.1428571	4.36E+07
P3	1000	40	5.656854249	360	8.15E+07			P3	1000	40	5.656854249	360	0.5	22	11	9.6	1.4	257.1428571	5.82E+07
P4	1000	50	5.656854249	360	1.02E+08			P4	1000	50	5.656854249	360	0.5	22	11	9.6	1.4	257.1428571	7.27E+07
P5	1000	60	5.656854249	360	1.22E+08			P5	1000	60	5.656854249	360	0.5	22	11	9.6	1.4	257.1428571	8.73E+07

P	C	R	$d^{\alpha}(2^{3})$	Tx(Degree)	P Total			P	C	R	$d^{\alpha}(2^{3})$	2π	$\epsilon R(50\% = 0.5 = -3DB)$	D (Directivity = 22degrees)	ϵRD	KH(K=1 and H= 9.6m)	($\epsilon RD - KH$)	$2\pi/(\epsilon RD - KH)$	P Total
P0	1000	10	8	360	2.88E+07			P0	1000	10	8	360	0.5	22	11	9.6	1.4	257.1428571	2.06E+07
P1	1000	20	8	360	5.76E+07			P1	1000	20	8	360	0.5	22	11	9.6	1.4	257.1428571	4.11E+07
P2	1000	30	8	360	8.64E+07			P2	1000	30	8	360	0.5	22	11	9.6	1.4	257.1428571	6.17E+07
P3	1000	40	8	360	1.15E+08			P3	1000	40	8	360	0.5	22	11	9.6	1.4	257.1428571	8.23E+07
P4	1000	50	8	360	1.44E+08			P4	1000	50	8	360	0.5	22	11	9.6	1.4	257.1428571	1.03E+08
P5	1000	60	8	360	1.73E+08			P5	1000	60	8	360	0.5	22	11	9.6	1.4	257.1428571	1.23E+08

P	C	R	$d^{\alpha}(2^{3.5})$	Tx(Degree)	P Total			P	C	R	$d^{\alpha}(2^{3.5})$	2π	$\epsilon R(50\% = 0.5 = -3DB)$	D (Directivity = 22degrees)	ϵRD	KH(K=1 and H= 9.6m)	($\epsilon RD - KH$)	$2\pi/(\epsilon RD - KH)$	P Total
P0	1000	10	11.3137085	360	4.07E+07			P0	1000	10	11.3137085	360	0.5	22	11	9.6	1.4	257.1428571	2.91E+07
P1	1000	20	11.3137085	360	8.15E+07			P1	1000	20	11.3137085	360	0.5	22	11	9.6	1.4	257.1428571	5.82E+07
P2	1000	30	11.3137085	360	1.22E+08			P2	1000	30	11.3137085	360	0.5	22	11	9.6	1.4	257.1428571	8.73E+07
P3	1000	40	11.3137085	360	1.63E+08			P3	1000	40	11.3137085	360	0.5	22	11	9.6	1.4	257.1428571	1.16E+08
P4	1000	50	11.3137085	360	2.04E+08			P4	1000	50	11.3137085	360	0.5	22	11	9.6	1.4	257.1428571	1.45E+08
P5	1000	60	11.3137085	360	2.44E+08			P5	1000	60	11.3137085	360	0.5	22	11	9.6	1.4	257.1428571	1.75E+08

P	C	R	$d^{\alpha}(2^4)$	Tx(Degree)	P Total			P	C	R	$d^{\alpha}(2^4)$	2π	$\epsilon R(50\% = 0.5 = -3DB)$	D (Directivity = 22degrees)	ϵRD	KH(K=1 and H= 9.6m)	($\epsilon RD - KH$)	$2\pi/(\epsilon RD - KH)$	P Total
P0	1000	10	16	360	5.76E+07			P0	1000	10	16	360	0.5	22	11	9.6	1.4	257.1428571	4.11E+07
P1	1000	20	16	360	1.15E+08			P1	1000	20	16	360	0.5	22	11	9.6	1.4	257.1428571	8.23E+07
P2	1000	30	16	360	1.73E+08			P2	1000	30	16	360	0.5	22	11	9.6	1.4	257.1428571	1.23E+08
P3	1000	40	16	360	2.30E+08			P3	1000	40	16	360	0.5	22	11	9.6	1.4	257.1428571	1.65E+08
P4	1000	50	16	360	2.88E+08			P4	1000	50	16	360	0.5	22	11	9.6	1.4	257.1428571	2.06E+08
P5	1000	60	16	360	3.46E+08			P5	1000	60	16	360	0.5	22	11	9.6	1.4	257.1428571	2.47E+08

iv. Change in power with respect to Constant Bitrate (c)

P	C	R	$d^{\wedge}a(2^{\wedge}3)$	Tx(Degree)	P Total			P	C	R	$d^{\wedge}a(2^{\wedge}3)$	2π	$\epsilon R(50\% = 0.5 = -3DB)$	D (Directivity = 22degrees)	ϵRD	KH(K=1 and H= 9.6m)	($\epsilon RD - KH$)	$2\pi/(\epsilon RD - KH)$	P Total
P0	200	10	8	360	5.76E+06			P0	200	10	8	360	0.5	22	11	9.6	1.4	257.1428571	4.11E+06
P1	200	20	8	360	1.15E+07			P1	200	20	8	360	0.5	22	11	9.6	1.4	257.1428571	8.23E+06
P2	200	30	8	360	1.73E+07			P2	200	30	8	360	0.5	22	11	9.6	1.4	257.1428571	1.23E+07
P3	200	40	8	360	2.30E+07			P3	200	40	8	360	0.5	22	11	9.6	1.4	257.1428571	1.65E+07
P4	200	50	8	360	2.88E+07			P4	200	50	8	360	0.5	22	11	9.6	1.4	257.1428571	2.06E+07
P5	200	60	8	360	3.46E+07			P5	200	60	8	360	0.5	22	11	9.6	1.4	257.1428571	2.47E+07

P	C	R	$d^{\wedge}a(2^{\wedge}3)$	Tx(Degree)	P Total			P	C	R	$d^{\wedge}a(2^{\wedge}3)$	2π	$\epsilon R(50\% = 0.5 = -3DB)$	D (Directivity = 22degrees)	ϵRD	KH(K=1 and H= 9.6m)	($\epsilon RD - KH$)	$2\pi/(\epsilon RD - KH)$	P Total
P0	400	10	8	360	1.15E+07			P0	400	10	8	360	0.5	22	11	9.6	1.4	257.1428571	8.23E+06
P1	400	20	8	360	2.30E+07			P1	400	20	8	360	0.5	22	11	9.6	1.4	257.1428571	1.65E+07
P2	400	30	8	360	3.46E+07			P2	400	30	8	360	0.5	22	11	9.6	1.4	257.1428571	2.47E+07
P3	400	40	8	360	4.61E+07			P3	400	40	8	360	0.5	22	11	9.6	1.4	257.1428571	3.29E+07
P4	400	50	8	360	5.76E+07			P4	400	50	8	360	0.5	22	11	9.6	1.4	257.1428571	4.11E+07
P5	400	60	8	360	6.91E+07			P5	400	60	8	360	0.5	22	11	9.6	1.4	257.1428571	4.94E+07

P	C	R	$d^{\wedge}a(2^{\wedge}3)$	Tx(Degree)	P Total			P	C	R	$d^{\wedge}a(2^{\wedge}3)$	2π	$\epsilon R(50\% = 0.5 = -3DB)$	D (Directivity = 22degrees)	ϵRD	KH(K=1 and H= 9.6m)	($\epsilon RD - KH$)	$2\pi/(\epsilon RD - KH)$	P Total
P0	800	10	8	360	2.30E+07			P0	800	10	8	360	0.5	22	11	9.6	1.4	257.1428571	1.65E+07
P1	800	20	8	360	4.61E+07			P1	800	20	8	360	0.5	22	11	9.6	1.4	257.1428571	3.29E+07
P2	800	30	8	360	6.91E+07			P2	800	30	8	360	0.5	22	11	9.6	1.4	257.1428571	4.94E+07
P3	800	40	8	360	9.22E+07			P3	800	40	8	360	0.5	22	11	9.6	1.4	257.1428571	6.58E+07
P4	800	50	8	360	1.15E+08			P4	800	50	8	360	0.5	22	11	9.6	1.4	257.1428571	8.23E+07
P5	800	60	8	360	1.38E+08			P5	800	60	8	360	0.5	22	11	9.6	1.4	257.1428571	9.87E+07

P	C	R	$d^{\wedge}a(2^{\wedge}3)$	Tx(Degree)	P Total			P	C	R	$d^{\wedge}a(2^{\wedge}3)$	2π	$\epsilon R(50\% = 0.5 = -3DB)$	D (Directivity = 22degrees)	ϵRD	KH(K=1 and H= 9.6m)	($\epsilon RD - KH$)	$2\pi/(\epsilon RD - KH)$	P Total
P0	1200	10	8	360	3.46E+07			P0	1200	10	8	360	0.5	22	11	9.6	1.4	257.1428571	2.47E+07
P1	1200	20	8	360	6.91E+07			P1	1200	20	8	360	0.5	22	11	9.6	1.4	257.1428571	4.94E+07
P2	1200	30	8	360	1.04E+08			P2	1200	30	8	360	0.5	22	11	9.6	1.4	257.1428571	7.41E+07
P3	1200	40	8	360	1.38E+08			P3	1200	40	8	360	0.5	22	11	9.6	1.4	257.1428571	9.87E+07
P4	1200	50	8	360	1.73E+08			P4	1200	50	8	360	0.5	22	11	9.6	1.4	257.1428571	1.23E+08
P5	1200	60	8	360	2.07E+08			P5	1200	60	8	360	0.5	22	11	9.6	1.4	257.1428571	1.48E+08

P	C	R	$d^{\wedge}a(2^{\wedge}3)$	Tx(Degree)	P Total			P	C	R	$d^{\wedge}a(2^{\wedge}3)$	2π	$\epsilon R(50\% = 0.5 = -3DB)$	D (Directivity = 22degrees)	ϵRD	KH(K=1 and H= 9.6m)	($\epsilon RD - KH$)	$2\pi/(\epsilon RD - KH)$	P Total
P0	1600	10	8	360	4.61E+07			P0	1600	10	8	360	0.5	22	11	9.6	1.4	257.1428571	3.29E+07
P1	1600	20	8	360	9.22E+07			P1	1600	20	8	360	0.5	22	11	9.6	1.4	257.1428571	6.58E+07
P2	1600	30	8	360	1.38E+08			P2	1600	30	8	360	0.5	22	11	9.6	1.4	257.1428571	9.87E+07
P3	1600	40	8	360	1.84E+08			P3	1600	40	8	360	0.5	22	11	9.6	1.4	257.1428571	1.32E+08
P4	1600	50	8	360	2.30E+08			P4	1600	50	8	360	0.5	22	11	9.6	1.4	257.1428571	1.65E+08
P5	1600	60	8	360	2.76E+08			P5	1600	60	8	360	0.5	22	11	9.6	1.4	257.1428571	1.97E+08

P	C	R	$d^{\wedge}a(2^{\wedge}3)$	Tx(Degree)	P Total			P	C	R	$d^{\wedge}a(2^{\wedge}3)$	2π	$\epsilon R(50\% = 0.5 = -3DB)$	D (Directivity = 22degrees)	ϵRD	KH(K=1 and H= 9.6m)	($\epsilon RD - KH$)	$2\pi/(\epsilon RD - KH)$	P Total
P0	2000	10	8	360	5.76E+07			P0	2000	10	8	360	0.5	22	11	9.6	1.4	257.1428571	4.11E+07
P1	2000	20	8	360	1.15E+08			P1	2000	20	8	360	0.5	22	11	9.6	1.4	257.1428571	8.23E+07
P2	2000	30	8	360	1.73E+08			P2	2000	30	8	360	0.5	22	11	9.6	1.4	257.1428571	1.23E+08
P3	2000	40	8	360	2.30E+08			P3	2000	40	8	360	0.5	22	11	9.6	1.4	257.1428571	1.65E+08
P4	2000	50	8	360	2.88E+08			P4	2000	50	8	360	0.5	22	11	9.6	1.4	257.1428571	2.06E+08
P5	2000	60	8	360	3.46E+08			P5	2000	60	8	360	0.5	22	11	9.6	1.4	257.1428571	2.47E+08

v. Change in power with respect to Distance (d)

P	C	R	$d^{\alpha}(2^{2})$	Tx(Degree)	P Total			P	C	R	$d^{\alpha}(2^{2})$	2π	$\epsilon R(50\% = 0.5 = -3DB)$	D (Directivity = 22degrees)	ϵRD	KH(K=1 and H= 9.6m)	($\epsilon RD - KH$)	$2\pi/(\epsilon RD - KH)$	P Total
P0	1000	10	4	360	1.44E+07			P0	1000	10	4	360	0.5	22	11	9.6	1.4	257.1428571	1.03E+07
P1	1000	20	4	360	2.88E+07			P1	1000	20	4	360	0.5	22	11	9.6	1.4	257.1428571	2.06E+07
P2	1000	30	4	360	4.32E+07			P2	1000	30	4	360	0.5	22	11	9.6	1.4	257.1428571	3.09E+07
P3	1000	40	4	360	5.76E+07			P3	1000	40	4	360	0.5	22	11	9.6	1.4	257.1428571	4.11E+07
P4	1000	50	4	360	7.20E+07			P4	1000	50	4	360	0.5	22	11	9.6	1.4	257.1428571	5.14E+07
P5	1000	60	4	360	8.64E+07			P5	1000	60	4	360	0.5	22	11	9.6	1.4	257.1428571	6.17E+07

P	C	R	$d^{\alpha}(3^{2})$	Tx(Degree)	P Total			P	C	R	$d^{\alpha}(3^{2})$	2π	$\epsilon R(50\% = 0.5 = -3DB)$	D (Directivity = 22degrees)	ϵRD	KH(K=1 and H= 9.6m)	($\epsilon RD - KH$)	$2\pi/(\epsilon RD - KH)$	P Total
P0	1000	10	9	360	3.24E+07			P0	1000	10	9	360	0.5	22	11	9.6	1.4	257.1428571	2.31E+07
P1	1000	20	9	360	6.48E+07			P1	1000	20	9	360	0.5	22	11	9.6	1.4	257.1428571	4.63E+07
P2	1000	30	9	360	9.72E+07			P2	1000	30	9	360	0.5	22	11	9.6	1.4	257.1428571	6.94E+07
P3	1000	40	9	360	1.30E+08			P3	1000	40	9	360	0.5	22	11	9.6	1.4	257.1428571	9.26E+07
P4	1000	50	9	360	1.62E+08			P4	1000	50	9	360	0.5	22	11	9.6	1.4	257.1428571	1.16E+08
P5	1000	60	9	360	1.94E+08			P5	1000	60	9	360	0.5	22	11	9.6	1.4	257.1428571	1.39E+08

P	C	R	$d^{\alpha}(4^{2})$	Tx(Degree)	P Total			P	C	R	$d^{\alpha}(4^{2})$	2π	$\epsilon R(50\% = 0.5 = -3DB)$	D (Directivity = 22degrees)	ϵRD	KH(K=1 and H= 9.6m)	($\epsilon RD - KH$)	$2\pi/(\epsilon RD - KH)$	P Total
P0	1000	10	16	360	5.76E+07			P0	1000	10	16	360	0.5	22	11	9.6	1.4	257.1428571	4.11E+07
P1	1000	20	16	360	1.15E+08			P1	1000	20	16	360	0.5	22	11	9.6	1.4	257.1428571	8.23E+07
P2	1000	30	16	360	1.73E+08			P2	1000	30	16	360	0.5	22	11	9.6	1.4	257.1428571	1.23E+08
P3	1000	40	16	360	2.30E+08			P3	1000	40	16	360	0.5	22	11	9.6	1.4	257.1428571	1.65E+08
P4	1000	50	16	360	2.88E+08			P4	1000	50	16	360	0.5	22	11	9.6	1.4	257.1428571	2.06E+08
P5	1000	60	16	360	3.46E+08			P5	1000	60	16	360	0.5	22	11	9.6	1.4	257.1428571	2.47E+08

P	C	R	$d^{\alpha}(5^{\circ}2)$	Tx(Degree)	P Total			P	C	R	$d^{\alpha}(5^{\circ}2)$	2π	$\epsilon R(50\% = 0.5 = -3DB)$	D (Directivity = 22degrees)	ϵRD	KH(K=1 and H= 9.6m)	($\epsilon RD - KH$)	$2\pi/(\epsilon RD - KH)$	P Total
P0	1000	10	25	360	9.00E+07			P0	1000	10	25	360	0.5	22	11	9.6	1.4	257.1428571	6.43E+07
P1	1000	20	25	360	1.80E+08			P1	1000	20	25	360	0.5	22	11	9.6	1.4	257.1428571	1.29E+08
P2	1000	30	25	360	2.70E+08			P2	1000	30	25	360	0.5	22	11	9.6	1.4	257.1428571	1.93E+08
P3	1000	40	25	360	3.60E+08			P3	1000	40	25	360	0.5	22	11	9.6	1.4	257.1428571	2.57E+08
P4	1000	50	25	360	4.50E+08			P4	1000	50	25	360	0.5	22	11	9.6	1.4	257.1428571	3.21E+08
P5	1000	60	25	360	5.40E+08			P5	1000	60	25	360	0.5	22	11	9.6	1.4	257.1428571	3.86E+08

P	C	R	$d^{\alpha}(6^{\circ}2)$	Tx(Degree)	P Total			P	C	R	$d^{\alpha}(4^{\circ}2)$	2π	$\epsilon R(50\% = 0.5 = -3DB)$	D (Directivity = 22degrees)	ϵRD	KH(K=1 and H= 9.6m)	($\epsilon RD - KH$)	$2\pi/(\epsilon RD - KH)$	P Total
P0	1000	10	36	360	1.30E+08			P0	1000	10	36	360	0.5	22	11	9.6	1.4	257.1429	9.26E+07
P1	1000	20	36	360	2.59E+08			P1	1000	20	36	360	0.5	22	11	9.6	1.4	257.1429	1.85E+08
P2	1000	30	36	360	3.89E+08			P2	1000	30	36	360	0.5	22	11	9.6	1.4	257.1429	2.78E+08
P3	1000	40	36	360	5.18E+08			P3	1000	40	36	360	0.5	22	11	9.6	1.4	257.1429	3.70E+08
P4	1000	50	36	360	6.48E+08			P4	1000	50	36	360	0.5	22	11	9.6	1.4	257.1429	4.63E+08
P5	1000	60	36	360	7.78E+08			P5	1000	60	36	360	0.5	22	11	9.6	1.4	257.1429	5.55E+08

vi. Change in power with respect to Number of Request (R)

P	C	R	$d^{\alpha}(2^{\wedge}3)$	Tx(Degree)	P Total			P	C	R	$d^{\alpha}(2^{\wedge}3)$	2π	$\epsilon R(50\% = 0.5 = -3DB)$	D (Directivity = 22degrees)	ϵRD	KH(K=1 and H= 9.6m)	($\epsilon RD - KH$)	$2\pi/(\epsilon RD - KH)$	P Total
P0	1000	5	8	360	1.44E+07			P0	1000	5	8	360	0.5	22	11	9.6	1.4	257.143	1.03E+07
P1	1000	10	8	360	2.88E+07			P1	1000	10	8	360	0.5	22	11	9.6	1.4	257.143	2.06E+07
P2	1000	15	8	360	4.32E+07			P2	1000	15	8	360	0.5	22	11	9.6	1.4	257.143	3.09E+07
P3	1000	20	8	360	5.76E+07			P3	1000	20	8	360	0.5	22	11	9.6	1.4	257.143	4.11E+07
P4	1000	25	8	360	7.20E+07			P4	1000	25	8	360	0.5	22	11	9.6	1.4	257.143	5.14E+07
P5	1000	30	8	360	8.64E+07			P5	1000	30	8	360	0.5	22	11	9.6	1.4	257.143	6.17E+07
P6	1000	35	8	360	1.01E+08			P6	1000	35	8	360	0.5	22	11	9.6	1.4	257.143	7.20E+07
P7	1000	40	8	360	1.15E+08			P7	1000	40	8	360	0.5	22	11	9.6	1.4	257.143	8.23E+07
P8	1000	45	8	360	1.30E+08			P8	1000	45	8	360	0.5	22	11	9.6	1.4	257.143	9.26E+07
P9	1000	50	8	360	1.44E+08			P9	1000	50	8	360	0.5	22	11	9.6	1.4	257.143	1.03E+08
P10	1000	55	8	360	1.58E+08			P10	1000	55	8	360	0.5	22	11	9.6	1.4	257.143	1.13E+08
P11	1000	60	8	360	1.73E+08			P11	1000	60	8	360	0.5	22	11	9.6	1.4	257.143	1.23E+08

Testing model for communication using MATLAB

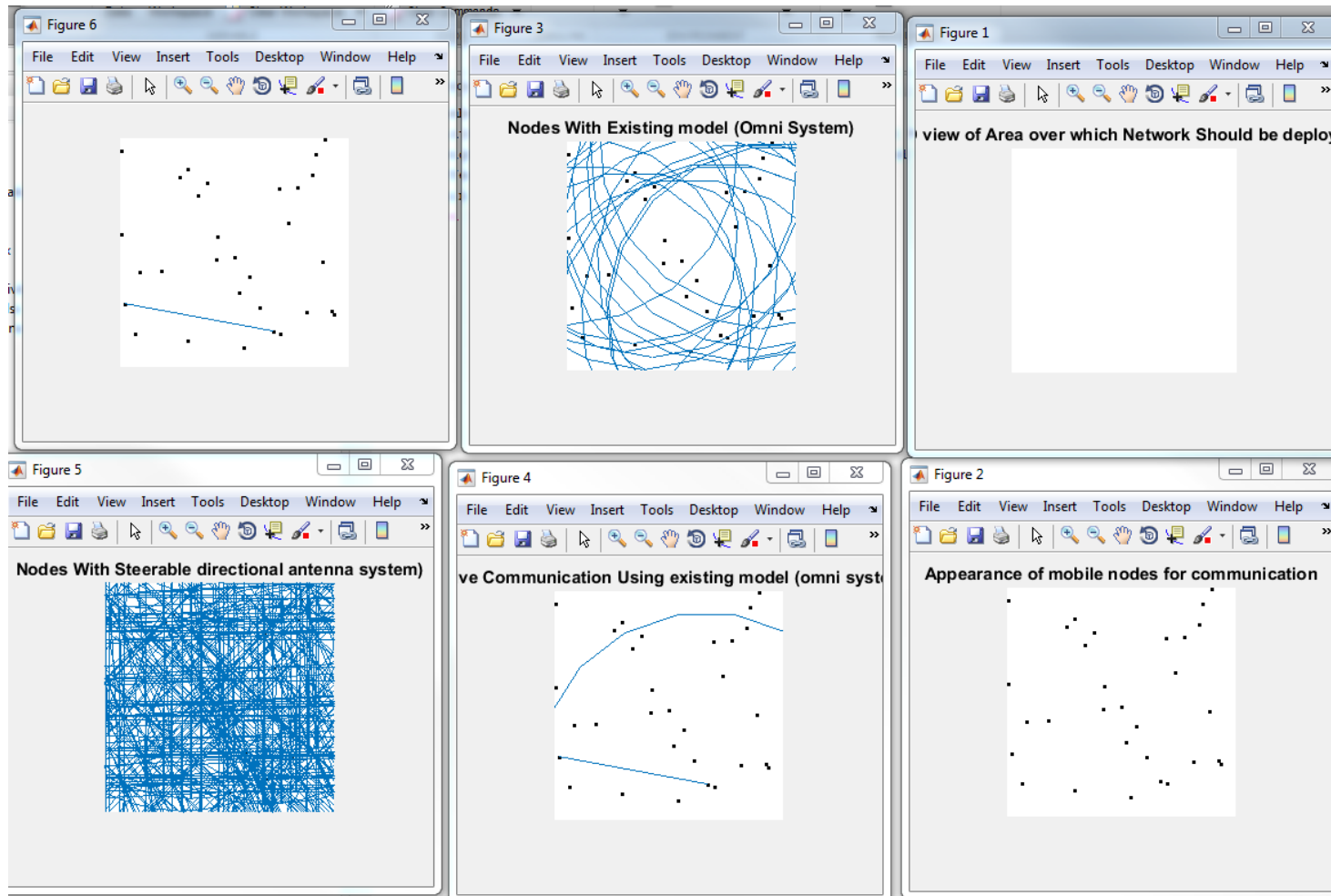

Appendix B

Justifications of using numerical values to test the proposed model

Justifications of using certain numerical values to verify the functionality of a proposed model of UWB-MAC protocol for MANET

The existing model

- i. Constant Bitrate (C): The constant bit rate used in the evaluation of the proposed model is from [115] which is from 0 – 2000Mbps because of the UWB system that supports high data rate with low energy consumption. [115] studied a developed model by considering CBR only for power consumption analysis in 3G mobile wireless network in regards to high data rate transmission.
- ii. Number of request (R): [116] highlights on the use of node density and CBR to evaluate the performance of protocols in MANETs. To get the optimum performance of developed model, a density of 10 – 60 is appropriate for testing. Because as the number of density varies, so also performance of a wireless network varies with respect to matrix used. [117] also studied different experimental evaluations used in simulation environment and the assumptions made based on developed models, a standard of 10 – 60 nodes is accepted to test the viability of a model.
- iii. Distance between mobile node (d): [118] developed a model that measures network connectivity for certain number of nodes in either random or uniformly placed along each other. The precise distance used between the nodes are 2-6m, and accurate performance of the model was measured. An assumption was made based on 2-6m distance which is also the radius of the radio range.
- iv. Propagation Channel (α): [119] examines the effect of propagation in a UWB signal through walls and other materials. The propagation channel is denoted with α and the

size is between 2-4. A fractional difference can be used for sect of numerical evaluation (example 2.5, 3.5).

- v. Omni directional antenna (General angle of transmission 360 or 2π or T_x): Omni-directional antenna operates from $0 - 360^0$ and is accepted generically.

The proposed model

- i. Efficiency of an Antenna (ϵ_R): The efficiency of an antenna in a wireless communication systems is half of the channel utilisation which is 0.5 or 50% [120]. More details on to determine the efficiency of an antenna is in [121].
- ii. Directivity of an Antenna (D):[122] performs analysis of using different direction of transmission and reception and 22^0 performed the best in terms packet delivery and easy connectivity between devices.
- iii. Height of an Antenna (H): in [120] analysis of antenna techniques were conducted based on different systems including the use of UWB for optimisation. For testing models, a range of 4.8 – 9ft is accepted, and is reasonable to test the validity of any developed model.

Appendix C

Physical and Channel testing and results

Transmission and Reception

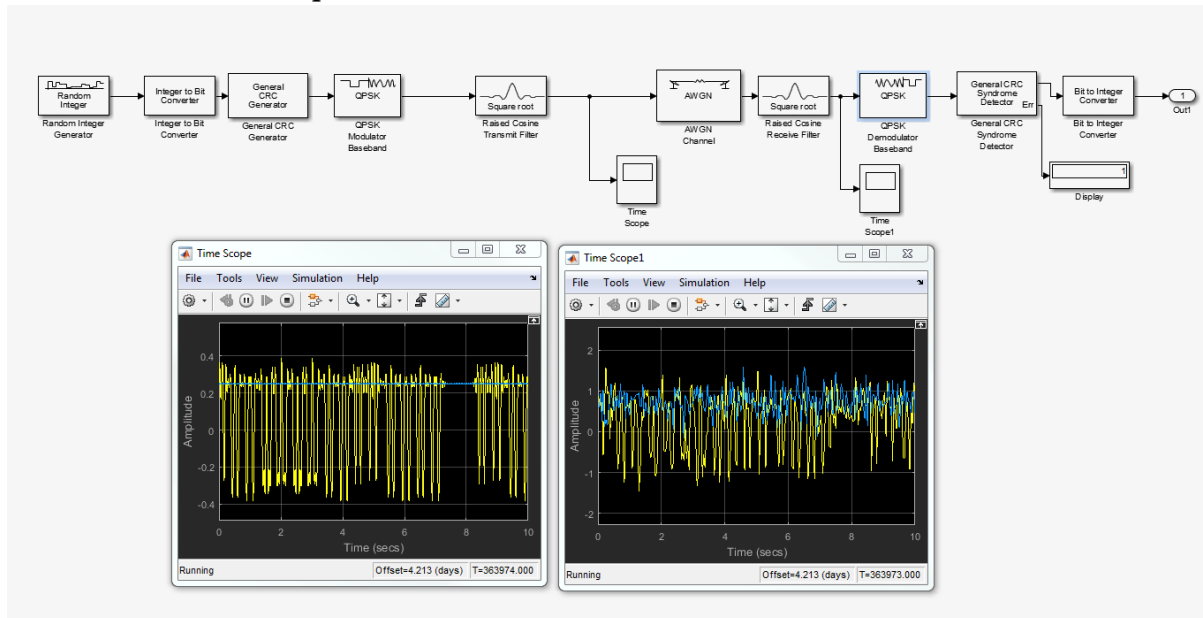

MB-OFDM demonstration codes

The channelization of the proposed model in Matlab code simulates the transmission of a base band MIMO signal for Multi Band Orthogonal Frequency Division Multiplexing (MB-OFDM) system. The blocks of the transmitter side in section 5.4 are implemented based on the standard specification provided in ECMA 368 standard. Six different functions was considered plus the main simulation code that integrate all the function in the channel. The functions considered in the implementation of the MB-OFDM are convolutional encodes in order to input data using ECMA standard which generate polynomials for the output signals and the patterns for reducing code rate in the channel. A function that coordinate Cyclic shift of interleaving bits in the channel was developed to monitor interleaving bits, input bits, shift, and number of bit per OFDM symbol. This will help in checking the size of input/output bits and to create permutation matrix for symbol interleaving and cyclic block by block over the input bits.

The OFDM simulation codes configure parameters and determine the source length of each signal for number of bits in the channel in form of binary sequence. The simulation codes create random binary source and scramble code which uses the ECMA standard to obtain encoded bits for modulation. Other functions like output vector, map the symbols created to data carriers, and this will guide the carriers and develop a platform for plotting carriers for MB-OFDM signals. The function is divided into number of data sub carriers, number of guard sub carriers and number of pilot sub carriers.

A function is developed for the modulation using QPSK modulator to support MB-OFDM system as recommended by ECMA standard. The function deals with only the modulation aspect of the channel and is carried out by grouping two consecutive bits of the vectors. The two vectors are sub functions which are input bit stream and complex value array representation. The complex value array represents the QPSK modulated symbols in order to resolve input bit stream in the channel. The modulation function is supported by two other functions to scramble bit vectors and interleaving code bit which generate pseudo-random bits to get the scramble output bits. Below are the functions created to support the PHY layer of the proposed model for transmission and reception part.

```
function [codedBitVector] = convEncode(inputBitVector)
function [interleavedBits] = cyclicIntrlv(inputBits,shift,bitsPerSymbol)
MB-OFDM System simulation code
function [outputVector] = mapCarriers(symbolVector)
function [modulatedVector] = modulateQPSK(inputBitVector)
function [scrambledBitVector] = scramble(inputBitVector, seedIdentifier)
function [interleavedBits] = symbolIntrlv(codedBits,tdsFactor,bitsPerSymbol)
function [interleavedBits] = toneIntrlv(inputBits,blockSize,bitsPerSymbol)
```

Appendix D

Linking MATLAB Simulink with ns-3

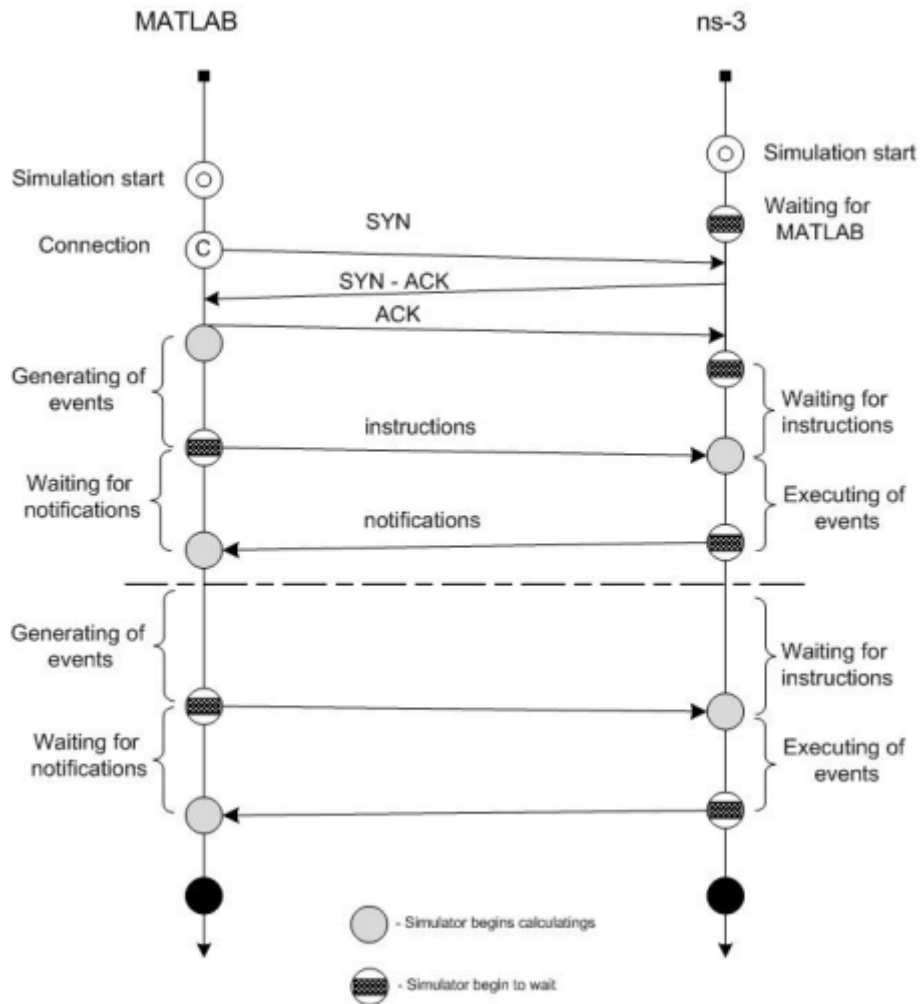

Some Simulation setup and Scenarios

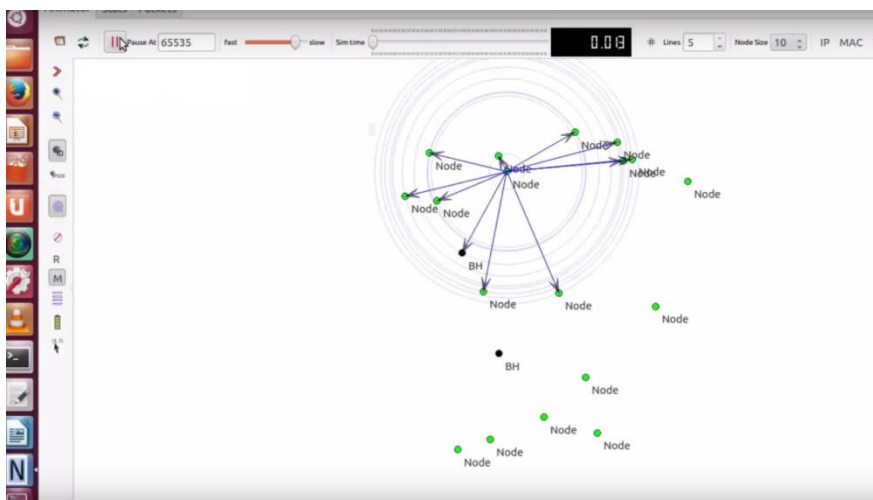
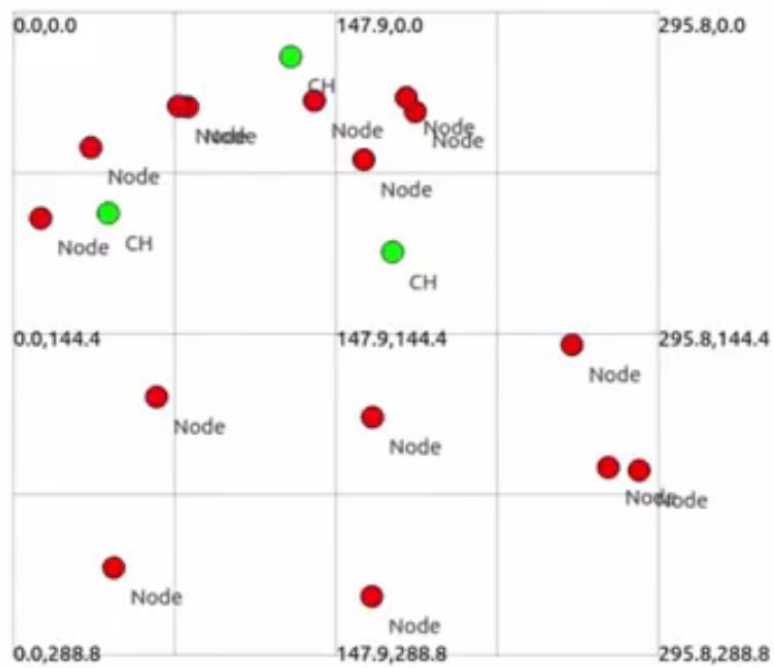
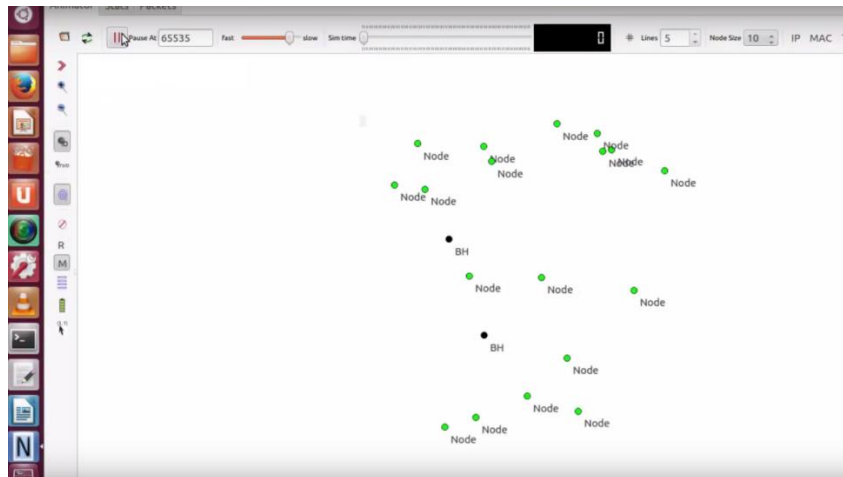

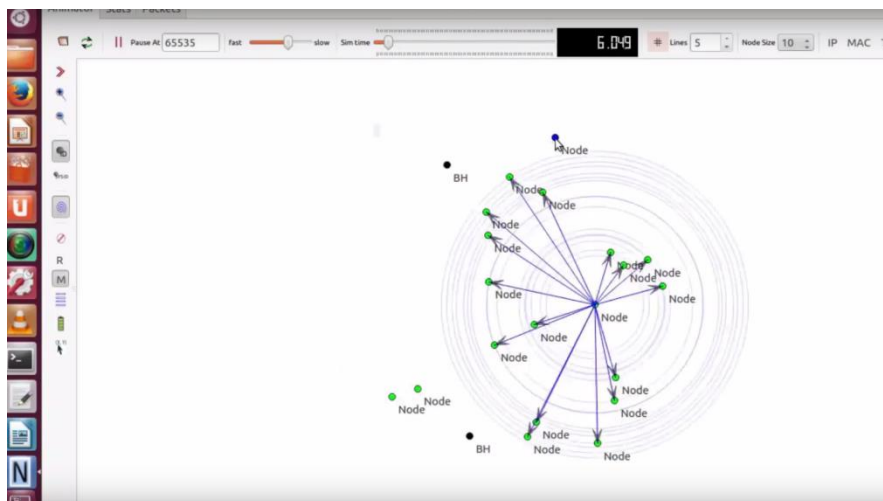
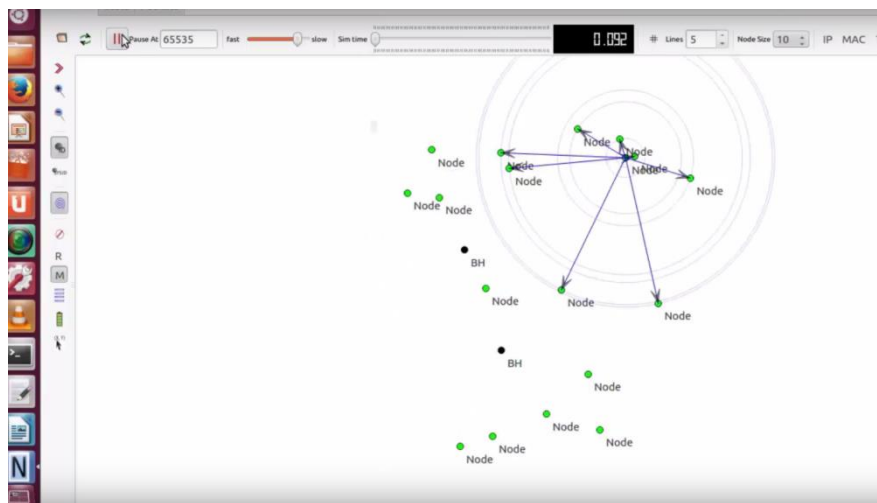
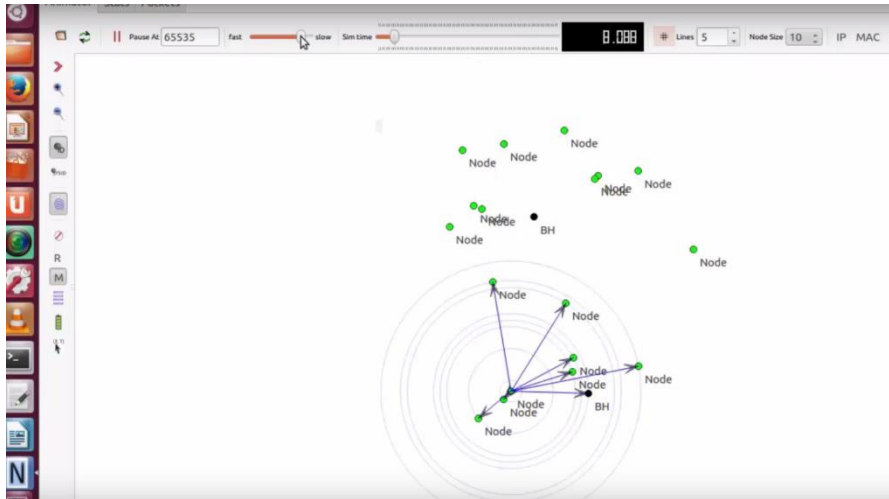

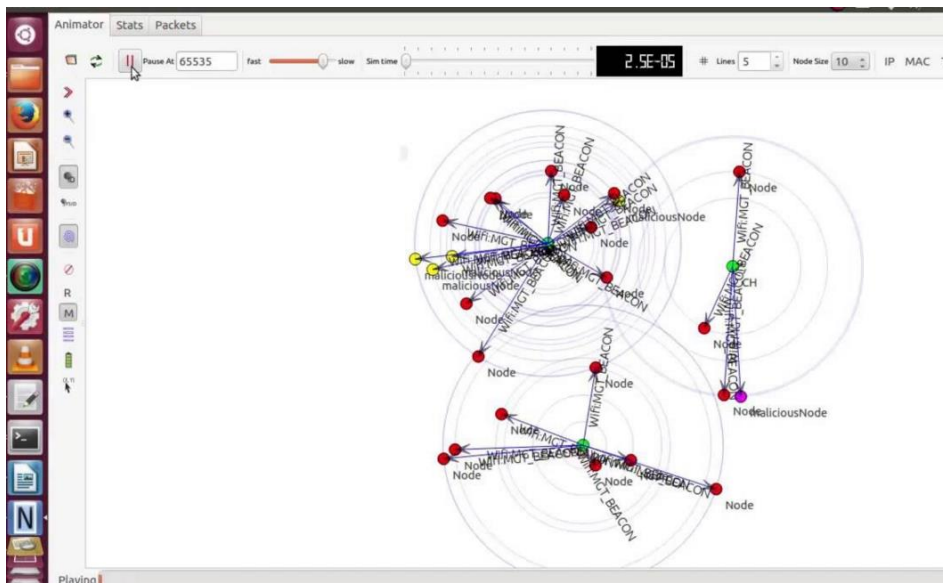
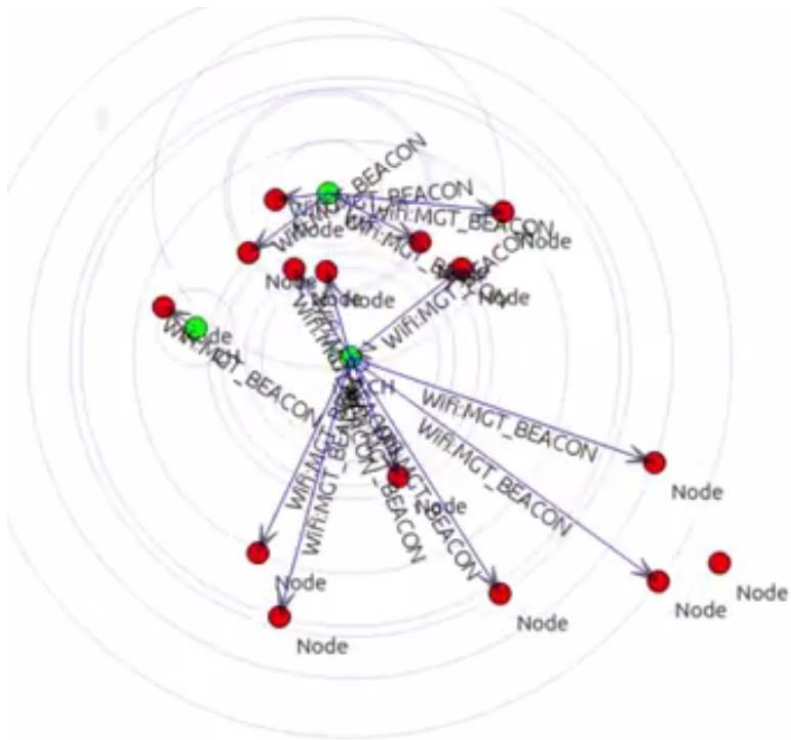

Simulations codes are available on request.

Appendix E

Publications

Conferences

1. M. Muhammad, M.D.Hope, *Increasing the energy efficiency of Ultra WideBand (UWB) enabled Mobile Ad Hoc Networks (MANETs) by optimising MAC protocols*, presented at the Salford Postgraduate Annual Research Conference (SPARC) 2015. 2015. p. pp. 39.
2. M. Muhammad, M.D.Hope, *Enhancing the energy efficiency of Ultra WideBand (UWB) based Media Access Control (MAC) protocols in Mobile Ad-Hoc Networks (MANETs) through the use of directional antenna*, presented at the Salford Postgraduate Annual Research Conference (SPARC) 2016. pp. 65
3. M. Muhammad, M.D.Hope, *Improving Energy Conservation in MANETs through the use of a Modified UWB MAC and Directional Antenna*, presented at the Salford Postgraduate Annual Research Conference (SPARC) 2017. pp. 55

Appendix References

1. Wang, L., A. Ukhanova, and E. Belyaev. *Power consumption analysis of constant bit rate data transmission over 3G mobile wireless networks*. in *ITS Telecommunications (ITST), 2011 11th International Conference on*. 2011. IEEE.
2. Adam, N., M. Ismail, and J. Abdullah. *Effect of node density on performances of three MANET routing protocols*. in *Electronic Devices, Systems and Applications (ICEDSA), 2010 Intl Conf on*. 2010. IEEE.
3. Newport, C., et al., *Experimental evaluation of wireless simulation assumptions*. *Simulation*, 2007. **83**(9): p. 643-661.
4. Foh, C.H. and B.S. Lee. *A closed form network connectivity formula one-dimensional MANETs*. in *Communications, 2004 IEEE International Conference on*. 2004. IEEE.
5. Safaai-Jazi, A., et al., *Ultra-wideband propagation measurements and channel modeling*. Report on Through-the-Wall Propagation and Material Characterization, 2002.
6. Patwari, N., *ECE 5325/6325: Wireless Communication Systems Lecture Notes, Fall 2011*.

7. *Antenna Efficiency*: <http://www.antenna-theory.com/basics/efficiency.php>. *Antenna Fundamentals*, 2016.
8. Kolar, V., *Challenges in directional antennas*. 2004, State University of New York at Binghamton, Computer Science Department.