

The Impact of Base Station Antennas Configuration on the Performance of Millimetre Wave 5G Networks

Naser Al-Falahy^{(1),(2)} and Omar Y. K. Alani⁽¹⁾
⁽¹⁾ University of Salford, Manchester, United Kingdom
⁽²⁾ University of Anbar, Iraq

N.F.A.AL-Falahy@edu.salford.ac.uk , O.Y.K.Alani@salford.ac.uk

Abstract— In this paper, two scenarios have been considered for millimetre wave base station configuration. In the first scenario, the approach of Distributed Base Station (DBS) with remote radio units (RRU) is chosen as the envisioned architecture for future 5G network. This approach is compatible with cloud radio access network (C-RAN), as it has easier scalability and compatibility with future network expansions and upgrades. RRU has been used in this work as a way to sidestep the limited coverage and poor channel condition, which characterise millimetre wave band. This will minimise the number of required sites installation for the same quality of service (QoS). The results of this approach have shown significant improvements in terms of User Equipment (UE) throughput, average cell throughput, and spectral efficiency. In the second scenario, optimising antenna element spacing is considered in the base station array. The results show significant improvement in the network performance and provide better performance for cell-edge users in terms of data throughput.

Keywords— 5G network; millimetre wave; distributed base station; RRH; antenna spacing.

I. INTRODUCTION

Due to the proliferation of smartphones, there is a high growth in mobile data traffic. Network providers face the need to install dense high capacity small-cells. These small-cells would cover small areas (less than 200m) with flexible provision to fulfil the unpredictable traffic demand. Network operators face many challenges such as very high speed data throughput, improving power and spectral efficiency, reducing cell deployment and operational cost.

In order to address these challenges, the vision of heterogeneous networks (HetNets), with distributed base station (DBS) approach where remote radio units/heads (RRU/RRH) are adopted to provide the necessary coverage and capacity improvement [1]. In this paper, the term RRH will be used for future representation.

DBS with RRH capability can have significant cost reduction, while improving the network performance, and power/spectral efficiency. This approach supports the scalability and flexibility when deploying new node (BBUs plus RRHs) to develop the next generation wireless networks [2].

Solutions to cope with this massive growth comprise HetNets that include macro-cells and small-cells, extending the operational frequency to higher carrier frequency in millimetre wave band, and distributed antenna systems (DAS) in the form of RRHs. The key advantages [2] of using RRHs are:

- Smaller footprint and easier installation, lower site rental costs, as well as optimized coverage.
- Software flexibility, remote upgrades and easier upgrades.
- Higher performance in terms of power/spectral efficiency.

In addition to these functionalities, RRH has been optimised to support 2x2, 4x4, and 8x8 MIMO, and has compatibility with active and smart antennas. The RRH can be mounted on tower, rooftop, and wall mount solutions.

The RRH system comprises of transceivers, duplexers, analogue to digital converters (ADC), power amplification (PA) and filtering processes. RRHs are connected to a base band unit BBU pool by fibre optic link at a high speed data rate. The new base station approach is paving the way for ultra-dense deployment for 5G network by making the network architecture scalable, flexible, efficient, and compatible with cloud radio access network (C-RAN) architecture.

The adoption of RRHs in mobile network has been used previously as a way to increase the network coverage in busy urban areas, as shown in [3], where the authors have made empirical measurements of the links between BBU and RRH. In [4] the authors have developed an algorithm to optimise the number of deployed RRHs based on game theory. The use of beamforming and cooperation multipoint (CoMP) among deployed RRHs has been studied in [5] and [6]. Whereas in [7] a dynamic reconfiguration algorithm has been proposed for clustering dense RRH deployments in C-RAN. The minimisation of the total power consumed by RRHs and BBUs is considered in [7] through joint consideration of the transport network power and RRHs transmission power.

In this paper, RRHs has been used to overcome the limited coverage of millimetre wave, and to establish MIMO link from distributed RRHs. In addition, optimising the antenna spacing in linear array is considered to improve the network performance in millimetre wave. Fig.1 shows the DBS network architecture. In this context, high speed cloud computing capability will undertake all the complex computational processing from all the connected BBUs to the cloud through the backhaul interface.

The rest of the paper is structured as follow: the DBS network model is illustrated in section II, followed by the results showing the improvement. In section III, the impact of optimising antenna spacing in millimetre wave is discussed, followed by the results that show the potential improvement of the new optimised array. Finally, the conclusions are drawn in section IV.

II. NETWORK MODEL

The network model is illustrated in fig.2, it consists of millimetre wave nodes that connect a number of User Equipment (UE) symbolised by the red dots, that either communicates directly to the central node (BBU) or indirectly through RRHs that are connected to the central node through a high speed fibre link. The distribution of UEs is considered to be a constant distribution of 10 UEs per single BBU (21 BBUs in total has been considered in this work). The distance among BBU's is 200m, while the RRHs have been located 50m away from their BBU's at a low altitude of 10m. The work has been conducted with system level simulation and Matlab.

Orthogonal Frequency Division Multiple Access (OFDMA) has been used as the multiple access in this model due to its powerful performance in dealing with multipath signals and compatibility with multi input multi output (MIMO) antennas. In OFDMA, the bandwidth is divided into small divisions called physical resource blocks (PRB) where each PRB is 180 kHz and has 12 adjacent OFDM subcarriers. The single PRB is allocated to a single device for at least single transmission time interval (TTI) that is equal to 1ms. This model supports bandwidth allocations of 1.4, 3, 5, 10, 15, and 20MHz, and can support higher bandwidths when higher connectivity is required. These bandwidths are equivalent to 6, 15, 25, 50, 75, and 100 PRB, respectively [8]. The bandwidth or resources will be shared among central node and its belonging RRUs. The following sub-sections will clarify the key enabling technologies used in this work.

A. Millimetre wave band

When higher network capacity and connectivity is required, additional spectrum is required as a result, and mobile network has improved the Quality of Service (QoS) by utilizing additional spectrum (higher frequency and wider bandwidth). Therefore, it is expected that 5G will also utilize higher spectrum, such as utilizing mm-wave band due to the very wide available bandwidth [9].

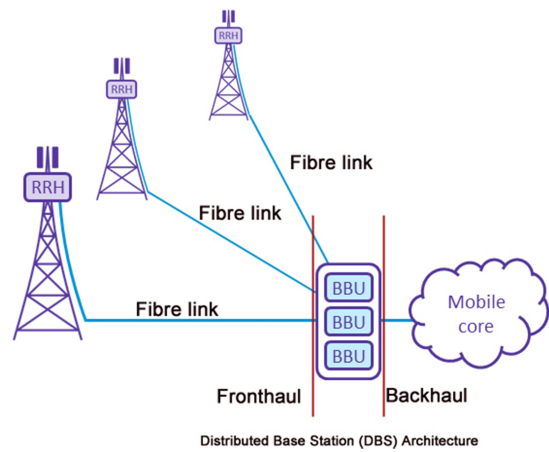

Fig.1 Distributed Base Station Architecture.

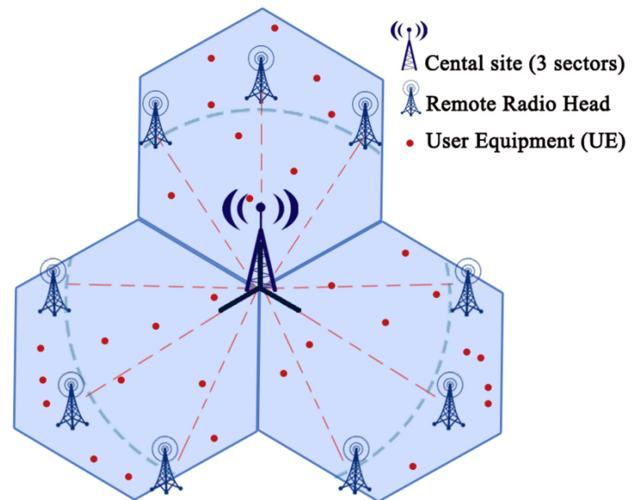

Fig.2. Network model showing central node with 3 sectors directional antenna, RRHs with directional antennas, and UEs (red dots). The dashed blue arch is the line where RRHs are deployed, whereas the dashed red lines represent the fibre links connecting RRHs to their BBUs.

According to the Federal Communications Commission (FCC), many bands within mm-wave band seem promising and can be a candidate for future 5G mobile system, including, local multipoint distribution service (LMDS) band from 28 to 30 GHz, 7GHz in the license-free band at 60GHz; which recently become 14GHz from 57 to 71GHz, as well as 12.9 GHz located at 71–76 GHz, 81–86 GHz, and 92–95 GHz from the E-band as shown in fig.3 [10][11]. Due to their small wavelengths, millimetre wave suffer high path loss and atmospheric attenuation and thus has limited coverage. However, this excess loss can be compensated by the means of deploying RRHs beyond node coverage and by beamforming.

B. Remote Radio Head

In the radio access network (RAN) [12], the mobile network architecture is considered with a single type of base station that is responsible for user coverage and traffic

exchange. The default implementation is a three sector solution, in which the base station is transmitting in these three sectors. An alternative approach is the Distributed Bas Station. This architecture splits the Base Station into two locations; a BBU at the central tower and RRHs mounted on the top of remotely located towers far away from the central BBU. In this fashion the RRHs would be connected to their BBU by a fibre optic link, which carries the signalling and powers the RRHs.

The latter case has found interest in C-RAN architecture, where multiple RRHs are fibre linked to the BBU that handles all the baseband processing. Signalling is exchanged over dedicated communication links (fronthaul) that link RRHs to their BBU. So far, the only fronthaul supporting data rates (around 10 Gbps) is the fibre links [13].

RRHs help increase the signal strength in the region of its deployment. Fig.4 shows the SINR mapping, where a three sectored site is deployed, and in each sector there are three RRHs to improve signal transmission at these areas. As per this figure, high SINR figures are reported in the areas of RRHs deployments.

In this work, RRH is used as a relay station to forward traffic far away from the central BBU, where these RRHs share the resources with the central unit. RRH's have been distributed apart from the central unit, on an arch with a radius of 50m, and arch width of 80 degrees. Their antennas are single antenna element with directional pattern, connected with a fibre link to the central node that has three sectors with directional antennas, the pattern is expressed by:

$$A(\theta) = -\min \left[12 \left(\frac{\theta}{\theta_{3dB}} \right)^2, A_m \right] \quad \text{where } -180 \leq \theta \leq 180 \quad (1)$$

where θ_{3dB} is the 3dB beamwidth which corresponds to 65 degrees, and $A_m = 20$ dB is the maximum attenuation.

And all UE's are equipped with omnidirectional antenna with 0dB gain. The distributed RRH can also support MIMO according to the device condition. When a device receives uncorrelated streams from more than one RRH that belongs to the same BBU simultaneously, the central BBU can configure Closed Loop Spatial Multiplexing (CLSM) on that device. Details of simulation parameters are shown in table I.

C. Path Loss

The path loss between a base station and connected device is represented by the propagation path loss plus the antenna gain at both ends. The path loss on the link between the access point (RRH) and a device is defined by the channel model [14]:

$$P_{ch} = 32.4 + 10n \log_{10}f + 20 \log_{10}R + X_\sigma \quad (2)$$

where: P_{ch} is the channel path loss between RRH and UE in dB, f is the carrier frequency in GHz, R is the separation between BS and UE in metres, n is the path loss exponent, and X_σ is the shadow fading loss which can be represented by log normal shadowing, that has zero mean and 9dB [15] standard deviation.

TABLE I NETWORK MODEL PARAMETERS

Model parameter	Value
Multiple access	OFDM, with normal cyclic prefix
Communication	Downlink
Tx Power	10 W
Tx antenna gain G_{Tx}	15 dB
Rx antenna gain G_{Rx}	0 dB
Tx pattern	As in eq.1
Electrical tilt	- 4 degree (down tilt)
Rx pattern	Omni-directional
Carrier frequency	28GHz
Remote Radio Heads	Yes
Speed of light	299792458 m/s
Wavelength	10.7 mm
Bandwidth	10 MHz and could be higher up to 1GHz
Antenna Type	SISO and MIMO
Tx mode	Closed Loop Spatial Multiplexing CLSM
Tx antenna elements	1,2, and 4
Tx Antenna height	10 m
Rx antenna height	1.5 m
Polarisation	X-POL and CO-POL
Modulation	Adaptive (QPSK, 16QAM, 64QAM)
Region of interest	ROI = 600x600 m ²
no. of BBU's	21 unit per ROI
Distance among BBUs	200m
no. of RRHs	Up to 63 RRHs, with 3 RRHs per BBU
Noise Figure	10 dB
Noise Density	-174 dBm/Hz
Traffic Model	Full Buffer
Scheduler	Proportional Fair

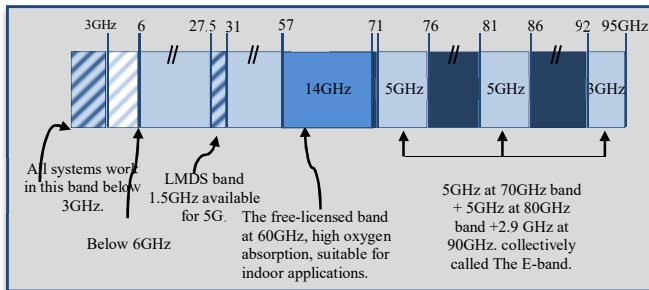

Fig.3 Millimetre-wave band as a candidate spectrum to 5G

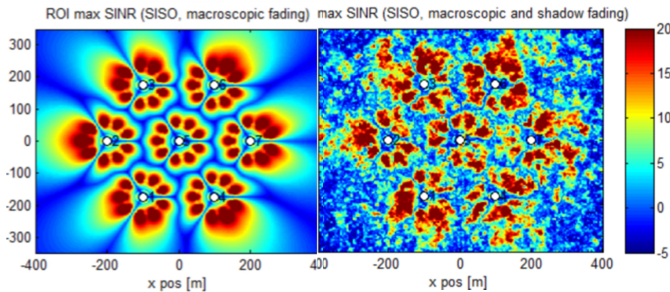

Fig.4 SINR mapping, BBUs each with three RRHs having directional antennas, left is path loss map and right is path loss plus shadowing map.

The work has been conducted in the 28GHz band as it could be the first choice among other millimetre wave band due to their stronger path gain with around 1GHz of available bandwidth. Three scenarios have been considered; the first scenario represents a single input single output (SISO) with no RRH deployments, shown in green on the results figures. The second scenario represents a (2x2/4x2) MIMO with no RRH, two RHH, or three RRH deployment, shown in red. The third scenario represents 4x4 MIMO and also with no RRH, two RRHs, or 3RRHs case, shown in blue on the results figures.

When using more RRHs, the probability of coverage will be improved and therefore the signal penetration will be highly improved. This means the resources are being used more efficiently, i.e., data throughput per PRB is higher. In addition distributing RRHs can support MIMO with line-of-site (LOS) transmission, since the new signals have less correlation in the LOS, and therefore support CLSM similar to the concept of distributed MIMO (D-MIMO).

Consequently, the spectral efficiency (bit/sec/Hz) will be improved. Fig.5 shows the spectral efficiency improvement and comparison when the deployment of network is considered with and without RRHs. As seen, the last scenario (3RRHs) has significant improvements in the spectral efficiency due to efficient use of resources in this case.

This improvement in spectral efficiency is reflected by significant improvement in both average UE throughput and average cell throughput. Fig.6 shows the average cell data throughput and average UE throughput (210 UEs). In this figure, improvement in data throughput is reported when the deployment of RRHs is considered, with the most improvement occurring in the case of 3RRHs per BBU.

Higher number of RRHs is also possible as DBS architecture support easier scalability and network flexibility. RRHs with higher number of antennas are also possible, where the single RRH can have and support 2x2, 4x4, and 8x8 antennas, with multi-mode operation and frequency agility.

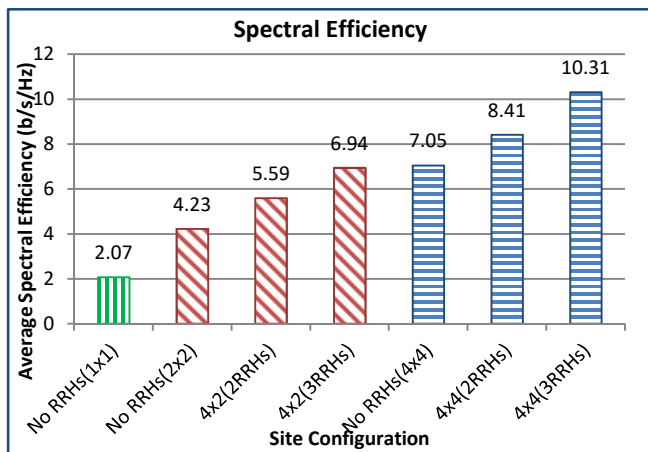

Fig.5 average spectral efficiency (b/s/Hz)

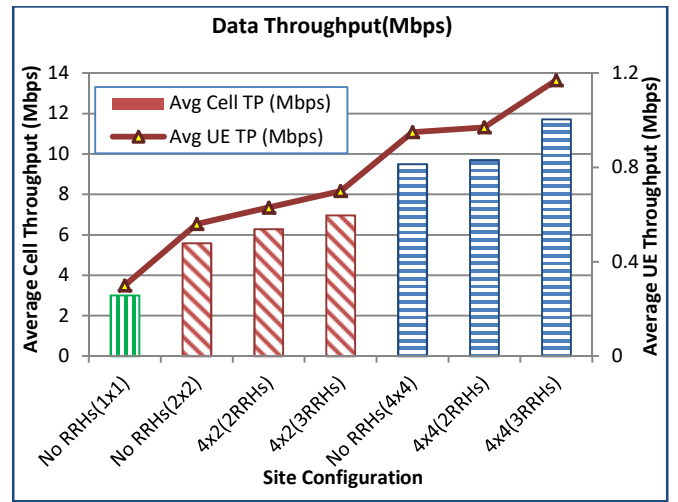

Fig.6 average cell and UE data throughput (Mbps)

III. OPTIMISING ANTENNA SEPARATION

The ability to support increased data rates without simultaneously increasing channel bandwidth motivates interest in MIMO communication links. MIMO links establish multiple parallel communication channels using closely spaced transmitter and receiver antenna elements.

An alternative approach, is millimetre-wave MIMO shown in fig.7, which establishes multiple parallel links in a LOS environment [16], as millimetre wave highly relies on LOS transmission. The basic theory for this system architecture first appeared in [17]. In this configuration, the transmitter and receiver use antenna array of 1×n elements or n×n square array of antenna elements spaced according to [18]:

The angular separation among the transmit array antenna is:

$$\theta_T \cong \frac{D}{R} \quad (3)$$

where D is the separation among antenna elements, and R is the distance between the transmitting antenna and UE antenna.

And the angular resolution seen by the UE antenna array is:

$$\theta_R \cong \frac{\lambda}{n \cdot D} \quad (4)$$

where n is the number of transmit array antenna elements and λ is the carrier wavelength

Now for appropriate separation in Tx antennas compared with Rx antennas,

$$\text{when } \theta_T \geq \theta_R \Rightarrow D = \sqrt{\frac{R \cdot \lambda}{n}} \quad (5)$$

In our work, we have used four antenna elements to establish MIMO channel. We have started by defining the antenna array for base station antenna (Tx antenna) by using uniform linear array (ULA) with vertically co-polarised element (COPOL) as shown in fig.8a. All antenna elements have 0 slant angle (vertically polarised). This assumption can be further extended to represent cross polarised array (XPOL) with $-45/45$ slant angles (X polarisation) as shown in the fig.8b, whereas the UE antennas is defined as in fig.8c.

In the system level simulation, ULA has been chosen for both base station & UE, with zero slant angles for all antennas elements. We have used seven base stations (21 cells) with ten UEs per cell (210 UEs in total) as shown in fig.9. The increase in antenna separation (d_h) in term of wavelength (λ) will provide spatial distribution among individual streams. This will increase the probability of having many streams from the same array with higher un-correlation among them to enable the BS to configure CLSM with the UEs [17].

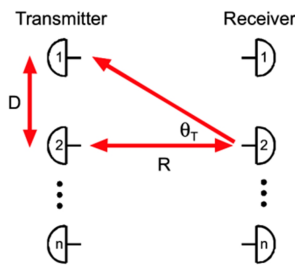

Fig.7 LOS MIMO system in millimetre wave band [16].

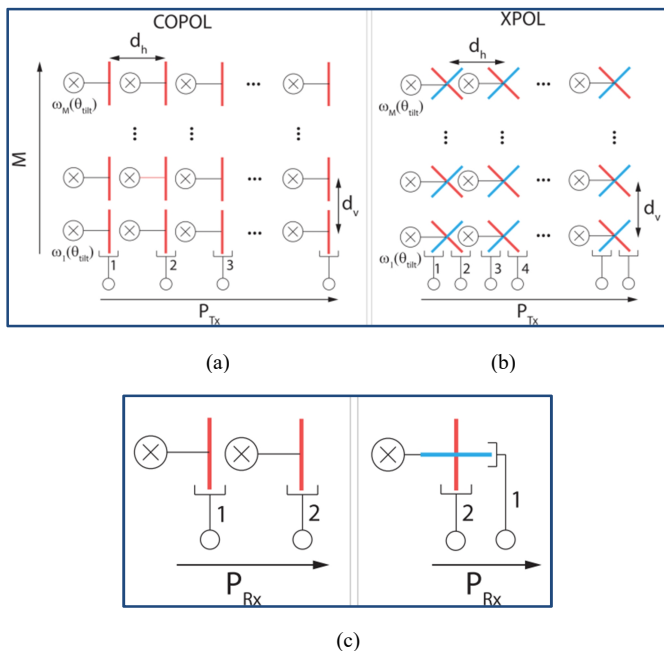

Fig.8 Antenna configuration and polarization modes at (a,b) base station antenna array and (c) UE antenna.

The results have proven considerable gain in average cell throughput compared with the default antenna spacing of 0.5λ . Higher spacing in the legacy bandwidth $<3\text{GHz}$ will result in a very big antenna array infrastructure, which could be considered to be impossible to implement on ground. However, with very small wavelength in the millimetre wave band, higher spacing in terms of wavelength will yield realistic antenna array size and therefore, higher spacing of $10, 20, 40\lambda$ has been considered.

The new scheme has also improved the cell-edge users, now cell edge users experienced a better SINR which consequently improved their data throughput. The work result is shown in fig.10, where the improvement in average cell and cell-edge throughput are shown. While in fig.11, a cumulative distribution function (CDF) is shown for the whole 210 UE; showing the average throughput of UEs in different antenna spacing options. These results show significant improvement in data throughput when higher spacing among antenna elements is used.

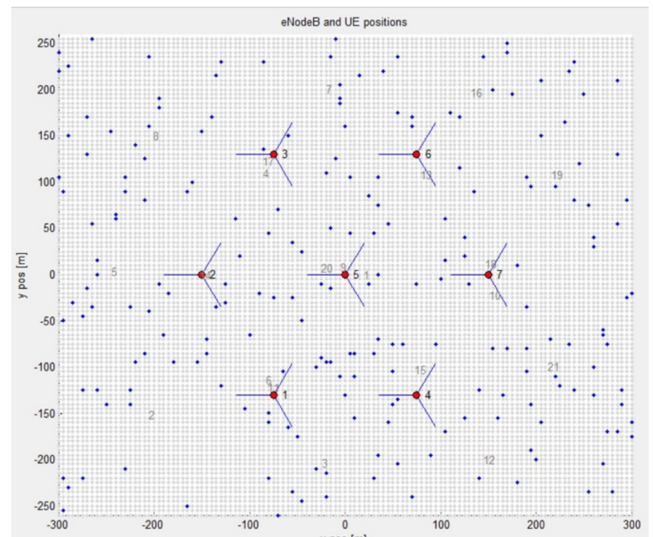

Fig.9 5G nodes & UE map with 150m inter-node-distance, and 210 UEs (dark dots) with 10 UEs per cell.

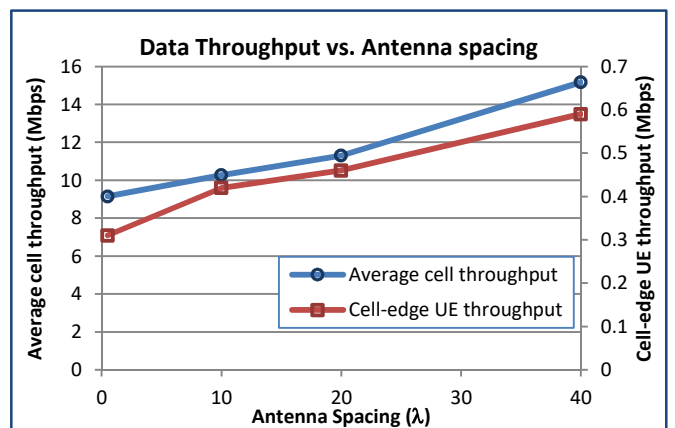

Fig.10 average cell throughput and cell-edge user throughput vs. antenna element spacing.

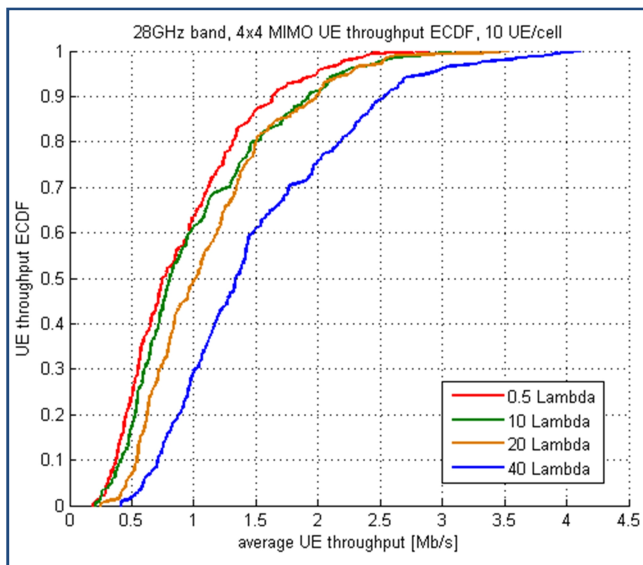

Fig.11 average UE throughput for multiple antenna element spacing.

Nevertheless, the spacing among antenna elements has its limitations. Firstly, using lower frequency means the antenna array size will become unrealistic, especially with higher number of antennas (e.g., massive MIMO). Moving the carrier frequency to higher frequency, e.g., (60GHz) will allow more room for spacing. The second limitation is considered when SINR begins deteriorating. This happens when the spacing is increased dramatically, which will consequently degrade the data throughput. Therefore, the spacing should be carefully optimised to improve the network performance.

IV. CONCLUSION

Due to their poor channel condition and short wavelengths, millimetre wave band can suffer high signal attenuation when they are adopted for mobile access, which will affect the overall network performance. In this work, two scenarios are considered. The first scenario is the distributed base station approach with remote radio head, which has been used to sidestep the high path loss and atmospheric attenuation through deploying RRHs instead of having all antennas co-located at the base station. The new RRHs will ensure higher SINR within their region of deployment. Furthermore distributing RRHs can facilitate the principle of MIMO in the line of site, and increase the un-correlation among the stream received by the UEs to enable the CLSM. This will improve overall network performance in terms of data throughput.

In the second scenario, optimising antenna spacing has been considered. The default antenna separation in the legacy cellular network is around half the wavelength. Higher separation would improve the signal transmission and reception and therefore increase the data throughput, but as the wavelength is too long, the separation will result in an unrealistic array size. In millimetre wave, this is no longer a problem due to their very shorter wavelengths. The work results have been presented with multiple antennas separations.

The results show significant gain in terms of average UE/cell data throughput and cell-edge user throughput.

Acknowledgment

This work is sponsored by the ministry of higher education and scientific research, University of Anbar, Iraq.

References

- [1] T. J. Stefan Geirhofer *et al.*, "Cooperation and operation of macro node and remote radio head deployments in heterogeneous networks," US patent 2012/0207105 A1, 2012.
- [2] C. F. Lanzani, G. Kardaras, and D. Boppana, "Remote Radio Heads and the evolution towards 4G networks," *ALTERA radiocomp white paper*, pp. 1–5, 2009.
- [3] L. Ahumada *et al.*, "Empirical evaluation of the received power gain when remote radio heads are used to enhance the coverage area in urban environments," *IEEE Trans. Wirel. Commun.*, vol. 12, no. 6, pp. 2830–2839, 2013.
- [4] B. Romanous *et al.*, "A Game Theoretic Approach for Optimizing Density of Remote Radio Heads in User Centric Cloud-Based Radio Access Network," *2015 IEEE Glob. Commun. Conf.*, pp. 1–6, 2015.
- [5] D. Matsuo *et al.*, "Shared Remote Radio Head architecture to realize semi-dynamic clustering in CoMP cellular networks," in *IEEE Globecom Workshops*, 2012, pp. 1145–1149.
- [6] Y. Zeng, X. Wen, Z. Lu, Y. Chen, and H. Shao, "Joint Remote Radio Head Activation and Beamforming for Energy Efficient C-RAN," in *International Symposium on Wireless Communication Systems (ISWCS)*, 2016, pp. 550–554.
- [7] W. Zhao and S. Wang, "Remote radio head selection for power saving in cloud radio access networks," in *IEEE 83rd Vehicular Technology Conference (VTC Spring)*, 2016, pp. 1–5.
- [8] 3GPP, "LTE; Evolved Universal Terrestrial Radio Access (E-UTRA); Physical layer procedures," *ETSI TS 136 213*, no. 3GPP TS 36.213 version 8.8.0 Release 8, pp. 1–79, 2009.
- [9] N. Al-Falahy and O. Alani, "Potential Technologies to 5G Network: Challenges and Opportunities," *IEEE IT Professional*, vol. 19, no. 1, pp. 12–20, 2017.
- [10] F. Boccardi, Robert W. Heath Jr., Angel Lozano, Thomas L. Marzetta, "Five Disruptive Technology Directions for 5G," *IEEE Commun. Mag.*, vol. 52, no. 2, pp. 74–80, 2014.
- [11] F. Khan and Z. Pi, "An Introduction to Millimeter-Wave Mobile Broadband Systems," *IEEE Commun. Mag.*, vol. 59, no. 6, pp. 101–107, 2011.
- [12] D. Erik, S. Parkvall, and S. Johan, *4G LTE/LTE-Advanced for Mobile Broadband*, First Edit. Oxford, Elsevier Ltd., 2011.
- [13] P. Rost *et al.*, "Cloud technologies for flexible 5G radio access networks," *IEEE Commun. Mag.*, vol. 52, no. 5, pp. 68–76, May 2014.
- [14] A. Ghosh *et al.*, "Millimeter-Wave Enhanced Local Area Systems: A High-Data-Rate Approach for Future Wireless Networks," *IEEE J. Sel. Areas Commun.*, vol. 32, no. 6, pp. 1152–1163, 2014.
- [15] G. R. MacCartney Jr, J. Zhang, S. Nie, and T. S. Rappaport, "Path Loss Models for 5G Millimeter Wave Propagation Channels in Urban Microcells," in *Globecom - Wireless Communications Symposium*, 2013, pp. 3948–3953.
- [16] C. Sheldon *et al.*, "Spatial multiplexing over a line-of-sight millimeter-wave MIMO link: A two-channel hardware demonstration at 1.2Gbps over 41m range," in *1st European Conference on Wireless Technology*, 2008, pp. 198–201.
- [17] D. Gesbert, H. Bolcskei, D. A. Gore, and A. J. Paulraj, "Outdoor MIMO wireless channels: models and performance prediction," *IEEE Trans. Commun.*, vol. 50, no. 12, pp. 1926–1934, 2002.
- [18] E. Torkildson, B. Ananthasubramaniam, U. Madhow, and M. Rodwell, "Millimeter-wave MIMO: Wireless Links at Optical Speeds," in *Proc. of 44th Allerton Conference on Communication, Control and Computing*, 2006, pp. 1–9.